

Very high accuracy (70  $\mu$ V), high bandwidth (3 MHz), high temperature (175  $^{\circ}$ C), zero-drift operational amplifiers

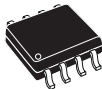

SOT23-5



SO8

#### Maturity status link

[TSZ181H1, TSZ182H1](#)

#### Related products

TSZ181H, TSZ182H	For - 40 / 150 $^{\circ}$ C range
TSZ181, TSZ182	For - 40 / 125 $^{\circ}$ C range

## Features

- AEC-Q100 qualified 
- Very high accuracy and stability:
  - 70  $\mu$ V max. offset voltage at 25  $^{\circ}$ C
  - 100  $\mu$ V offset voltage over full temperature range
- Rail-to-rail input and output
- Low supply voltage: 2.2 - 5.5 V
- Low power consumption: 1 mA max. at 5 V
- Gain bandwidth product: 3 MHz
- Automotive qualification
- Extended temperature range: -40 to 175  $^{\circ}$ C
- Micropackage: SOT23-5, SO8
- Benefits:
  - Higher accuracy without calibration
  - Accuracy virtually unaffected by temperature change

## Applications

- High accuracy signal conditioning
- Current measurement
- Sensor signal conditioning
- Automotive

## Description

The **TSZ181H1** single and **TSZ182H1** dual operational amplifiers feature very low offset voltages with virtually zero drift versus temperature changes. The **TSZ181H1** and **TSZ182H1** offer rail-to-rail input and output, excellent speed/power consumption ratio, and 3 MHz gain bandwidth product, while consuming just 1 mA at 5 V. The device operates over an extended range of -40 to +175 $^{\circ}$ C and features an ultra-low input bias current. These features make the **TSZ181H1** and **TSZ182H1** ideal for high-accuracy high-bandwidth sensor interfaces for automotive environment.

# 1 Pin connections

Figure 1. Pin connections (top view)

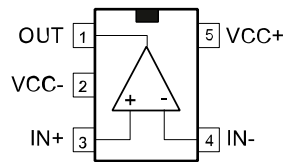

SOT23-5 (TSZ181H1)

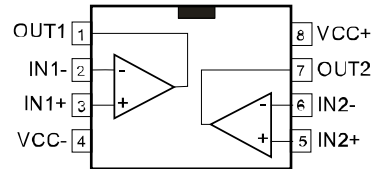

SO8 (TSZ182H1)

## 2 Absolute maximum ratings and operating conditions

**Table 1. Absolute maximum ratings**

Symbol	Parameter	Value	Unit
$V_{CC}$	Supply voltage <sup>(1)</sup>	6	V
$V_{id}$	Differential input voltage <sup>(2)</sup>	$\pm V_{CC}$	V
$V_{in}$	Input voltage <sup>(3)</sup>	$(V_{CC-}) - 0.2$ to $(V_{CC+}) + 0.2$	V
$I_{in}$	Input current <sup>(4)</sup>	10	mA
$T_{stg}$	Storage temperature	-65 to 150	°C
$T_j$	Junction temperature	180	°C
$R_{th-ja}$	Thermal resistance junction to ambient <sup>(5) (6)</sup>		°C/W
	SO8	125	
	SOT23-5	250	
ESD	Human Body Model (HBM) <sup>(7)</sup>	4	kV
	Charged Device Model (CDM) <sup>(8)</sup>	1.5	

1. All voltage values, except differential voltage, are with respect to network ground terminal.
2. The differential voltage is the non-inverting input terminal with respect to the inverting input terminal.
3.  $V_{CC} - V_{in}$  must not exceed 6 V,  $V_{in}$  must not exceed 6 V.
4. Input current must be limited by a resistor in series with the inputs.
5.  $R_{th}$  are typical values.
6. Short-circuits can cause excessive heating and destructive dissipation.
7. Human body model: 100 pF discharged through a 1.5 kΩ resistor between two pins of the device, done for all couples of pin combinations with other pins floating.
8. Charged device model: all pins plus package are charged together to the specified voltage and then discharged directly to ground.

**Table 2. Operating conditions**

Symbol	Parameter	Value	Unit
$V_{CC}$	Supply voltage	2.2 to 5.5	V
$V_{icm}$	Common mode voltage on input pins	$(V_{CC-}) - 0.1$ to $(V_{CC+}) + 0.1$	V
T	Operating free-air temperature range	-40 to 175	°C

### 3 Electrical characteristics

**Table 3. Electrical characteristics at  $V_{CC+} = 2.2\text{ V}$ ,  $V_{CC-} = 0\text{ V}$ ,  $V_{icm} = V_{CC}/2$ ,  $T = 25\text{ °C}$ ,  $R_L = 10\text{ k}\Omega$  connected to  $V_{CC}/2$  (unless otherwise specified)**

Symbol	Parameter	Conditions	Min	Typ	Max	Unit
<b>DC performance</b>						
$V_{IO}$	Input offset voltage	$T = 25\text{ °C}$		3.5	70	$\mu\text{V}$
		$T_{min} < T < T_{max}$			100	
$ \Delta V_{IO}/\Delta T $	Input offset voltage drift <sup>(1)</sup>	$T_{min} < T < T_{max}$			0.26	$\mu\text{V}/\text{°C}$
$I_{IB}$	Input bias current ( $V_{OUT} = V_{CC}/2$ ) <sup>(2)</sup>	$T = 25\text{ °C}$		30	200	pA
		$T_{min} < T < T_{max}$		225		
$I_{IO}$	Input offset current ( $V_{OUT} = V_{CC}/2$ ) <sup>(2)</sup>	$T = 25\text{ °C}$		60	400	pA
		$T_{min} < T < T_{max}$		150		
CMR1	Common-mode rejection ratio <sup>(3)</sup> , $V_{ic} = 0\text{ V to }V_{CC}$ , $V_{OUT} = V_{CC}/2$ , $R_L > 1\text{ M}\Omega$	$T = 25\text{ °C}$	88	115		dB
		$T_{min} < T < T_{max}$	86			
$A_{vd}$	Large signal voltage gain, $V_{OUT} = 0.5\text{ V to } (V_{CC} - 0.5\text{ V})$	$T = 25\text{ °C}$	102	130		dB
		$T_{min} < T < T_{max}$	92			
$V_{OH}$	High-level output voltage, $V_{OH} = V_{CC} - V_{OUT}$	$T = 25\text{ °C}$		15	40	mV
		$T_{min} < T < T_{max}$			70	
$V_{OL}$	Low-level output voltage	$T = 25\text{ °C}$		10	30	mV
		$T_{min} < T < T_{max}$			70	
$I_{OUT}$	$I_{sink} (V_{OUT} = V_{CC})$	$T = 25\text{ °C}$	4	6		mA
		$T_{min} < T < T_{max}$	1.87			
	$I_{source} (V_{OUT} = 0\text{ V})$	$T = 25\text{ °C}$	3.5	4		
		$T_{min} < T < T_{max}$	1.4			
$I_{CC}$	Supply current per channel, $V_{OUT} = V_{CC}/2$ , $R_L > 1\text{ M}\Omega$	$T = 25\text{ °C}$		0.7	1	
		$T_{min} < T < T_{max}$			1.2	
<b>AC performance</b>						
GBP	Gain bandwidth product, $R_L = 10\text{ k}\Omega$ , $C_L = 100\text{ pF}$	$T = 25\text{ °C}$	1.6	2.3		MHz
		$T_{min} < T < T_{max}$	1			
$\Phi_m$	Phase margin	$R_L = 10\text{ k}\Omega$ , $C_L = 100\text{ pF}$		59		degrees
$G_m$	Gain margin			16		dB
SR	Slew rate <sup>(4)</sup>	$T = 25\text{ °C}$	3	4.6		V/ $\mu\text{s}$
		$T_{min} < T < T_{max}$	2.5			
$t_s$	Settling time	To 0.1%, $V_{in} = 0.8\text{ V}_{pp}$		500		ns
$e_n$	Equivalent input noise voltage density	$f = 1\text{ kHz}$		50		nV/ $\sqrt{\text{Hz}}$
		$f = 10\text{ kHz}$		50		
$e_{n-pp}$	Voltage noise	$f = 0.1\text{ to }10\text{ Hz}$		0.6		$\mu\text{V}_{pp}$
$C_S$	Channel separation	$f = 1\text{ kHz}$		120		dB
$t_{init}$	Initialization time, $G = 100$ <sup>(5)</sup>	$T = 25\text{ °C}$		60		$\mu\text{s}$
		$T_{min} < T < T_{max}$		120		

1. *Input offset measurements are performed on x100 gain configuration. The amplifiers and the gain setting resistors are at the same temperature.*
2. *Guaranteed by design.*
3. *CMR is defined as  $20 \times \text{LOG}(\Delta V_{icm} / \Delta V_{io})$ .*
4. *Slew rate value is calculated as the average between positive and negative slew rates.*
5. *Initialization time is defined as the delay between the moment when supply voltage exceeds 2.2 V and output voltage stabilization.*

**Table 4. Electrical characteristics at  $V_{CC+} = 3.3\text{ V}$ ,  $V_{CC-} = 0\text{ V}$ ,  $V_{icm} = V_{CC}/2$ ,  $T = 25\text{ }^{\circ}\text{C}$ ,  $R_L = 10\text{ k}\Omega$  connected to  $V_{CC}/2$  (unless otherwise specified)**

Symbol	Parameter	Conditions	Min	Typ	Max	Unit
<b>DC performance</b>						
$V_{IO}$	Input offset voltage	$T = 25\text{ }^{\circ}\text{C}$		2	70	$\mu\text{V}$
		$T_{min} < T < T_{max}$			100	
$ \Delta V_{IO}/\Delta T $	Input offset voltage drift <sup>(1)</sup>	$T_{min} < T < T_{max}$			0.26	$\mu\text{V}/^{\circ}\text{C}$
$I_{IB}$	Input bias current ( $V_{OUT} = V_{CC}/2$ ) <sup>(2)</sup>	$T = 25\text{ }^{\circ}\text{C}$		30	200	pA
		$T_{min} < T < T_{max}$		225		
$I_{IO}$	Input offset current ( $V_{OUT} = V_{CC}/2$ ) <sup>(2)</sup>	$T = 25\text{ }^{\circ}\text{C}$		60	400	pA
		$T_{min} < T < T_{max}$		150		
CMR1	Common-mode rejection ratio <sup>(3)</sup> , $V_{ic} = 0\text{ V to } V_{CC}$ , $V_{OUT} = V_{CC}/2$ , $R_L > 1\text{ M}\Omega$	$T = 25\text{ }^{\circ}\text{C}$	96	120		dB
		$T_{min} < T < T_{max}$	94			
CMR2	Common-mode rejection ratio <sup>(3)</sup> , $V_{OUT} = V_{CC}/2$ , $R_L > 1\text{ M}\Omega$	$T = 25\text{ }^{\circ}\text{C}$ , $V_{ic} = 0\text{ to } V_{CC} - 1.8\text{ V}$	109	132		dB
		$T_{min} < T < T_{max}$ , $V_{ic} = 0\text{ to } V_{CC} - 2\text{ V}$	103			
$A_{vd}$	Large signal voltage gain, $V_{OUT} = 0.5\text{ V to } (V_{CC} - 0.5\text{ V})$	$T = 25\text{ }^{\circ}\text{C}$	110	138		
		$T_{min} < T < T_{max}$	95			
$V_{OH}$	High-level output voltage, $V_{OH} = V_{CC} - V_{OUT}$	$T = 25\text{ }^{\circ}\text{C}$		16	40	mV
		$T_{min} < T < T_{max}$			70	
$V_{OL}$	Low-level output voltage	$T = 25\text{ }^{\circ}\text{C}$		11	30	mV
		$T_{min} < T < T_{max}$			70	
$I_{OUT}$	$I_{sink}$ ( $V_{OUT} = V_{CC}$ )	$T = 25\text{ }^{\circ}\text{C}$	10	15		mA
		$T_{min} < T < T_{max}$	6.1			
	$I_{source}$ ( $V_{OUT} = 0\text{ V}$ )	$T = 25\text{ }^{\circ}\text{C}$	6	11		
		$T_{min} < T < T_{max}$	2.8			
$I_{CC}$	Supply current per channel, $V_{OUT} = V_{CC}/2$ , $R_L > 1\text{ M}\Omega$	$T = 25\text{ }^{\circ}\text{C}$		0.7	1	
		$T_{min} < T < T_{max}$			1.2	
<b>AC performance</b>						
GBP	Gain bandwidth product, $R_L = 10\text{ k}\Omega$ , $C_L = 100\text{ pF}$	$T = 25\text{ }^{\circ}\text{C}$	2	2.8		MHz
		$T_{min} < T < T_{max}$	1.2			
$\Phi_m$	Phase margin	$R_L = 10\text{ k}\Omega$ , $C_L = 100\text{ pF}$		56		degrees
$G_m$	Gain margin			15		dB
SR	Slew rate <sup>(4)</sup>	$T = 25\text{ }^{\circ}\text{C}$	2.6	4.5		V/ $\mu\text{s}$
		$T_{min} < T < T_{max}$	2.1			
$t_s$	Settling time	$T_0\text{ to }0.1\%$ , $V_{in} = 1.2\text{ V}_{pp}$		550		ns
$e_n$	Equivalent input noise voltage density	$f = 1\text{ kHz}$		40		nV/ $\sqrt{\text{Hz}}$
		$f = 10\text{ kHz}$		40		
$e_{n-pp}$	Voltage noise	$f = 0.1\text{ to }10\text{ Hz}$		0.5		$\mu\text{V}_{pp}$
$C_S$	Channel separation	$f = 1\text{ kHz}$		120		dB
$t_{init}$	Initialization time, $G = 100$ <sup>(5)</sup>	$T = 25\text{ }^{\circ}\text{C}$		60		$\mu\text{s}$
		$T_{min} < T < T_{max}$		120		

1. *Input offset measurements are performed on x100 gain configuration. The amplifiers and the gain setting resistors are at the same temperature.*
2. *Guaranteed by design.*
3. *CMR is defined as  $20 \times \text{LOG}(\Delta V_{icm} / \Delta V_{io})$*
4. *Slew rate value is calculated as the average between positive and negative slew rates.*
5. *Initialization time is defined as the delay between the moment when supply voltage exceeds 2.2 V and output voltage stabilization.*

**Table 5. Electrical characteristics at  $V_{CC+} = 5\text{ V}$ ,  $V_{CC-} = 0\text{ V}$ ,  $V_{icm} = V_{CC}/2$ ,  $T = 25\text{ }^{\circ}\text{C}$ ,  $R_L = 10\text{ k}\Omega$  connected to  $V_{CC}/2$  (unless otherwise specified)**

Symbol	Parameter	Conditions	Min	Typ	Max	Unit
<b>DC performance</b>						
$V_{IO}$	Input offset voltage	$T = 25\text{ }^{\circ}\text{C}$		1	70	$\mu\text{V}$
		$T_{min} < T < T_{max}$			100	
$ \Delta V_{IO}/\Delta T $	Input offset voltage drift <sup>(5)</sup>	$T_{min} < T < T_{max}$			0.26	$\mu\text{V}/^{\circ}\text{C}$
$I_{IB}$	Input bias current ( $V_{OUT} = V_{CC}/2$ ) <sup>(2)</sup>	$T = 25\text{ }^{\circ}\text{C}$		30	200	$\mu\text{A}$
		$T_{min} < T < T_{max}$		225		
$I_{IO}$	Input offset current ( $V_{OUT} = V_{CC}/2$ ) <sup>(2)</sup>	$T = 25\text{ }^{\circ}\text{C}$		60	400	$\mu\text{A}$
		$T_{min} < T < T_{max}$		150		
CMR1	Common-mode rejection ratio <sup>(3)</sup> , $V_{ic} = 0\text{ V to }V_{CC}$ , $V_{OUT} = V_{CC}/2$ , $R_L > 1\text{ M}\Omega$	$T = 25\text{ }^{\circ}\text{C}$	103	126		$\text{dB}$
		$T_{min} < T < T_{max}$	101			
CMR2	Common-mode rejection ratio <sup>(3)</sup> , $V_{OUT} = V_{CC}/2$ , $R_L > 1\text{ M}\Omega$	$T = 25\text{ }^{\circ}\text{C}$ $V_{ic} = 0\text{ to }V_{CC} - 1.8\text{ V}$	112	136		$\text{dB}$
		$T_{min} < T < T_{max}$ , $V_{ic} = 0\text{ to }V_{CC} - 2\text{ V}$	106			
SVR1	Supply voltage rejection ratio <sup>(4)</sup> , $V_{CC} = 2.2\text{ to }5.5\text{ V}$ , $V_{ic} = 0\text{ V}$ , $R_L > 1\text{ M}\Omega$	$T = 25\text{ }^{\circ}\text{C}$	101	123		$\text{dB}$
		$T_{min} < T < T_{max}$	99			
$A_{vd}$	Large signal voltage gain, $V_{OUT} = 0.5\text{ V to }(V_{CC} - 0.5\text{ V})$	$T = 25\text{ }^{\circ}\text{C}$	110	144		$\text{dB}$
		$T_{min} < T < T_{max}$	104			
EMIRR	EMI rejection ratio <sup>(5)</sup>	$V_{RF} = 100\text{ mVp}$ , $f = 400\text{ MHz}$		52		$\text{dB}$
		$V_{RF} = 100\text{ mVp}$ , $f = 900\text{ MHz}$		52		
		$V_{RF} = 100\text{ mVp}$ , $f = 1800\text{ MHz}$		72		
		$V_{RF} = 100\text{ mVp}$ , $f = 2400\text{ MHz}$		85		
$V_{OH}$	High-level output voltage, $V_{OH} = V_{CC} - V_{OUT}$	$T = 25\text{ }^{\circ}\text{C}$		18	40	$\text{mV}$
		$T_{min} < T < T_{max}$			70	
$V_{OL}$	Low-level output voltage	$T = 25\text{ }^{\circ}\text{C}$		13	30	$\text{mV}$
		$T_{min} < T < T_{max}$			70	
$I_{OUT}$	$I_{sink} (V_{OUT} = V_{CC})$	$T = 25\text{ }^{\circ}\text{C}$	20	29		$\text{mA}$
		$T_{min} < T < T_{max}$	12			
	$I_{source} (V_{OUT} = 0\text{ V})$	$T = 25\text{ }^{\circ}\text{C}$	15	25		
		$T_{min} < T < T_{max}$	7			
$I_{CC}$	Supply current per channel, $V_{OUT} = V_{CC}/2$ , $R_L > 1\text{ M}\Omega$	$T = 25\text{ }^{\circ}\text{C}$		0.8	1	$\text{mA}$
		$T_{min} < T < T_{max}$			1.2	
<b>AC performance</b>						
GBP	Gain bandwidth product, $R_L = 10\text{ k}\Omega$ , $C_L = 100\text{ pF}$	$T = 25\text{ }^{\circ}\text{C}$	2	3		$\text{MHz}$
		$T_{min} < T < T_{max}$	1.2			



Symbol	Parameter	Conditions	Min	Typ	Max	Unit
$\Phi_m$	Phase margin	$R_L = 10\text{ k}\Omega, C_L = 100\text{ pF}$		56		degrees
$G_m$	Gain margin			15		dB
SR	Slew rate <sup>(6)</sup>	$T = 25\text{ }^\circ\text{C}$	2.9	4.7		V/ $\mu\text{s}$
		$T_{\text{min}} < T < T_{\text{max}}$	2.4			
$t_s$	Settling time	To 0.1%, $V_{\text{in}} = 1.5\text{ Vpp}$		600		ns
		To 0.01%, $V_{\text{in}} = 1\text{ Vpp}$		4		$\mu\text{s}$
$e_n$	Equivalent input noise voltage density	$f = 1\text{ kHz}$		37		nV/ $\sqrt{\text{Hz}}$
		$f = 10\text{ kHz}$		37		
$e_{n\text{-pp}}$	Voltage noise	$f = 0.1\text{ to }10\text{ Hz}$		0.4		$\mu\text{Vpp}$
$C_S$	Channel separation	$f = 100\text{ Hz}$		135		dB
$t_{\text{init}}$	Initialization time, $G = 100$ <sup>(7)</sup>	$T = 25\text{ }^\circ\text{C}$		60		$\mu\text{s}$
		$T_{\text{min}} < T < T_{\text{max}}$		100		

1. Input offset measurements are performed on x100 gain configuration. The amplifiers and the gain setting resistors are at the same temperature.
2. Guaranteed by design.
3. CMR is defined as  $20 \times \text{LOG}(\Delta V_{\text{icm}} / \Delta V_{\text{io}})$ .
4. SVR is defined as  $20 \times \text{LOG}(\Delta V_{\text{cc}} / \Delta V_{\text{io}})$ .
5. EMIRR is defined as  $-20 \text{Log}(V_{\text{RF\_Peak}} / \Delta V_{\text{io}})$ . Tested on the MiniSO8 package, RF injection on the IN- pin.
6. Slew rate value is calculated as the average between positive and negative slew rates.
7. Initialization time is defined as the delay between the moment when supply voltage exceeds 2.2 V and output voltage stabilization.

## 4 Typical performance characteristics

Figure 2. Supply current vs. supply voltage

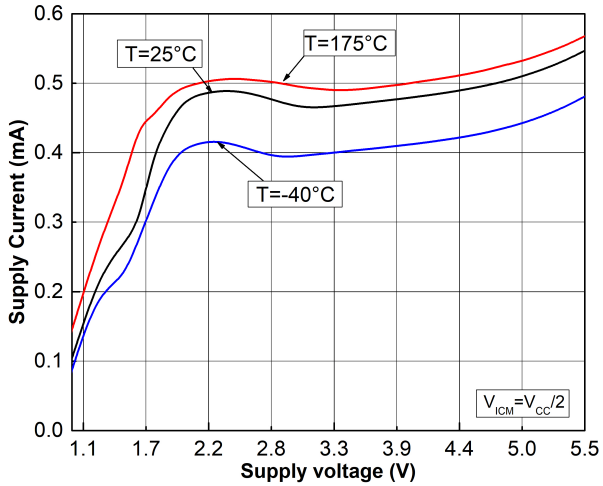

Figure 3. Input offset voltage distribution at  $V_{CC} = 5\text{ V}$

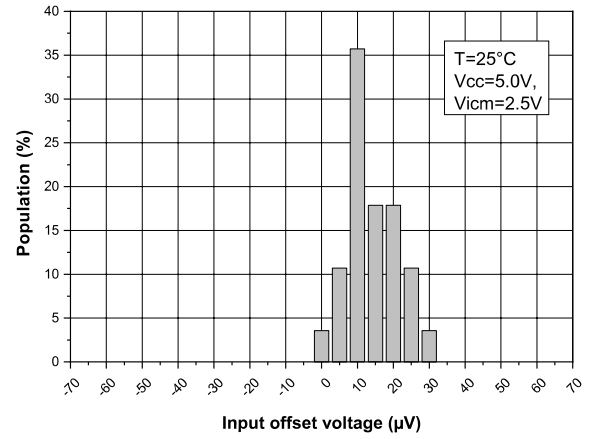

Figure 4. Input offset voltage distribution at  $V_{CC} = 3.3\text{ V}$

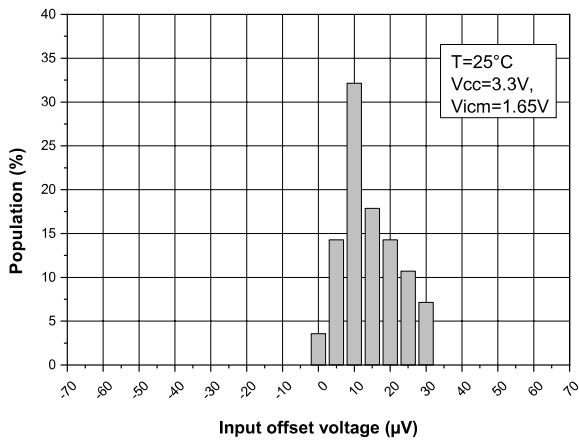

Figure 5. Input offset voltage distribution at  $V_{CC} = 2.2\text{ V}$

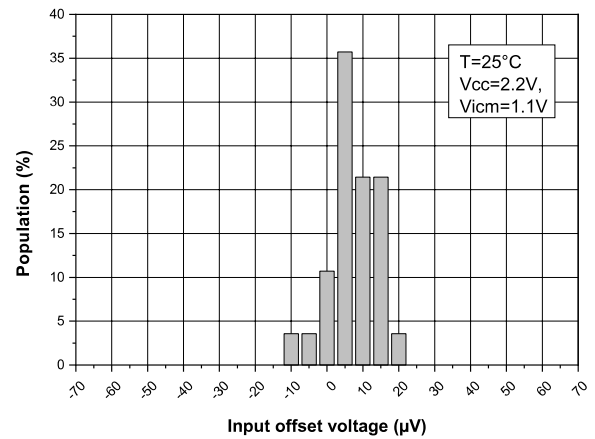

Figure 6. Input offset voltage distribution at  $V_{CC} = 5\text{ V}$ ,  
 $T = 175\text{ }^{\circ}\text{C}$

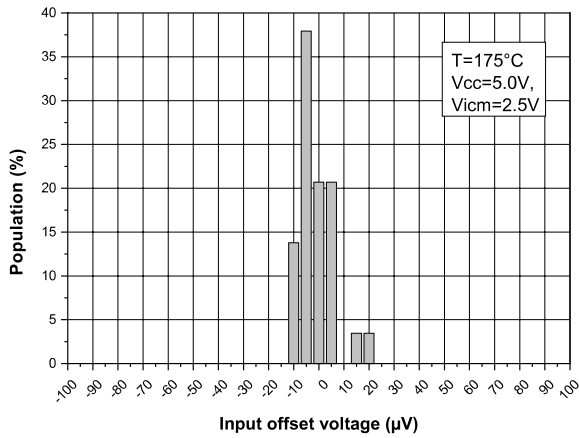

Figure 7. Input offset voltage distribution at  $V_{CC} = 5\text{ V}$ ,  
 $T = -40\text{ }^{\circ}\text{C}$

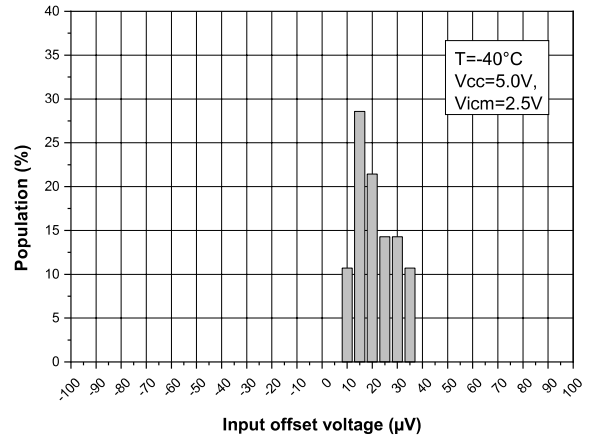

Figure 8. Input offset voltage distribution at  $V_{CC} = 2.2\text{ V}$ ,  
 $T = 175\text{ }^{\circ}\text{C}$

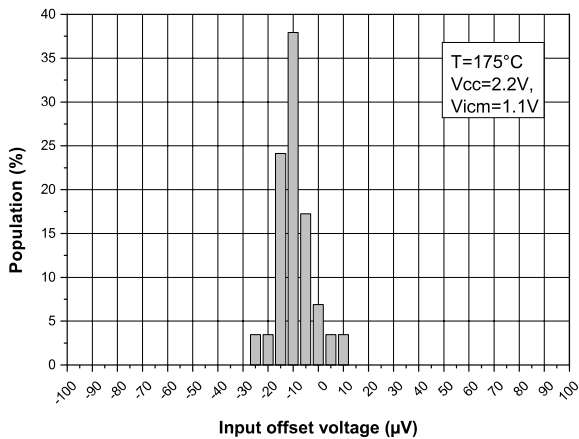

Figure 9. Input offset voltage distribution at  $V_{CC} = 2.2\text{ V}$ ,  
 $T = -40\text{ }^{\circ}\text{C}$

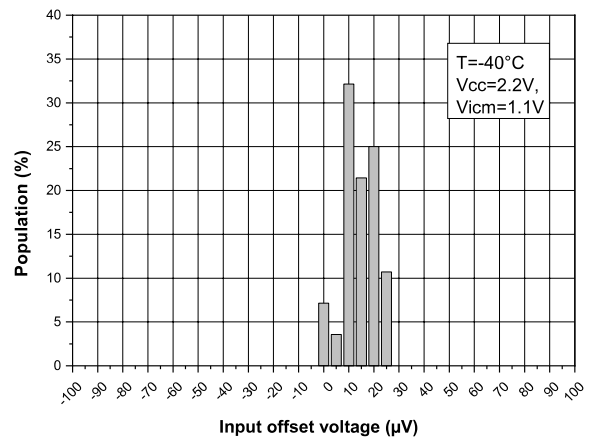

Figure 10. Input offset voltage vs. supply voltage

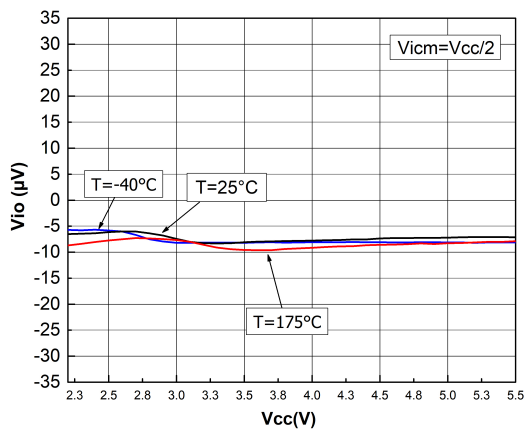

Figure 11. Input offset voltage vs. input common mode at  
 $V_{CC} = 5.5\text{ V}$

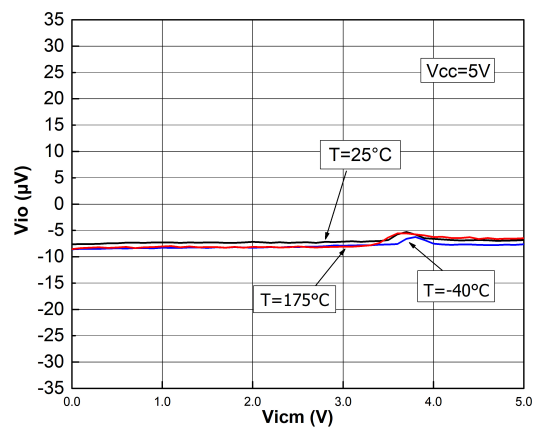

Figure 12. Input offset voltage vs. input common mode at  $V_{CC} = 3.3\text{ V}$

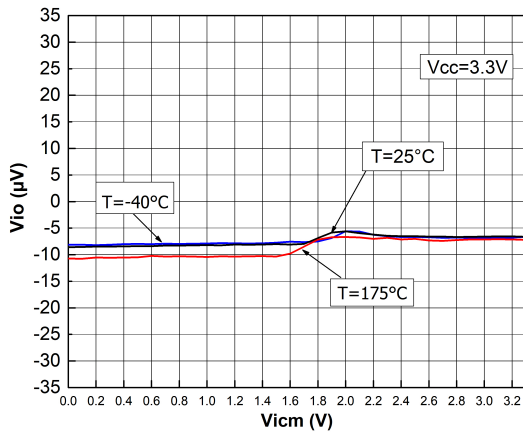

Figure 13. Input offset voltage vs. input common mode at  $V_{CC} = 2.2\text{ V}$

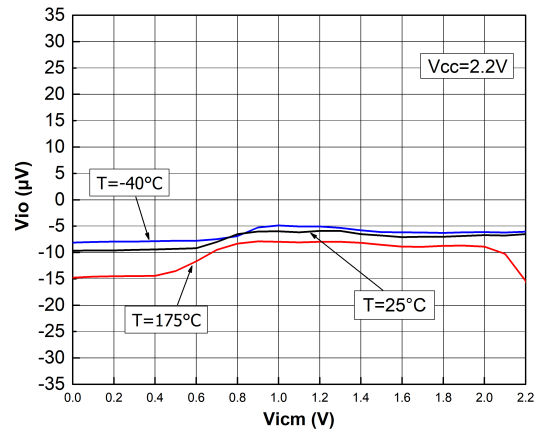

Figure 14. Input offset voltage vs. temperature

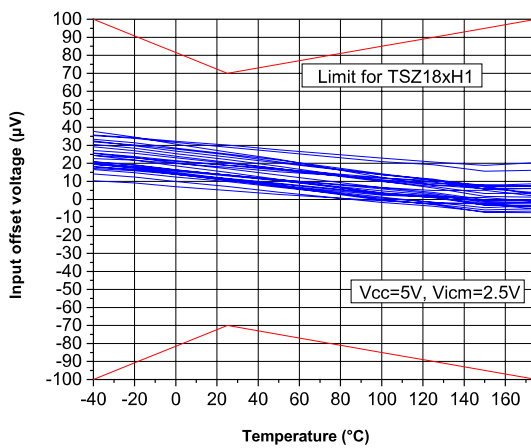

Figure 15.  $V_{OH}$  vs. supply voltage

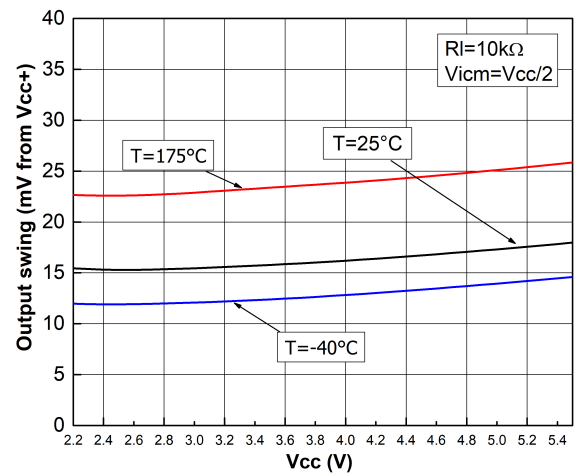

Figure 16.  $V_{OL}$  vs. supply voltage

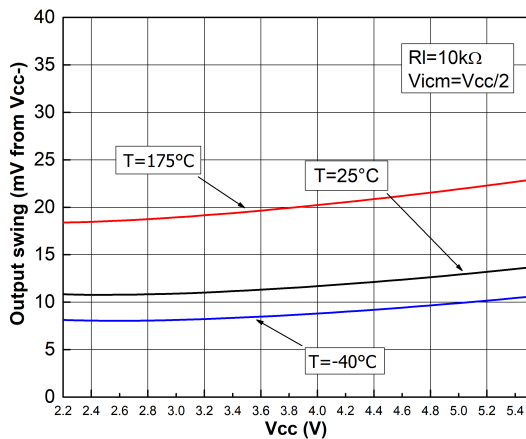

Figure 17. Output current vs. output voltage at  $V_{CC} = 5\text{ V}$

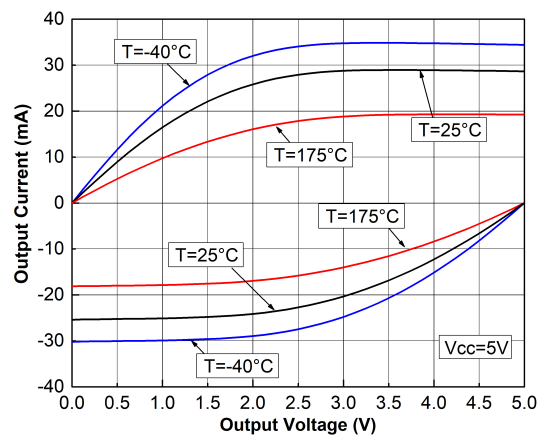

Figure 18. Output current vs. output voltage at  $V_{CC} = 2.2\text{ V}$

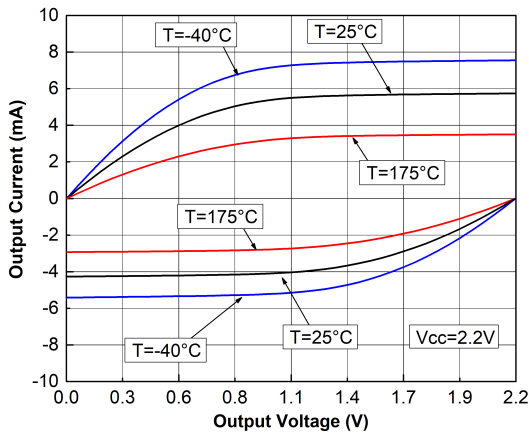

Figure 19. Input bias current vs. common-mode at  $V_{CC} = 5\text{ V}$

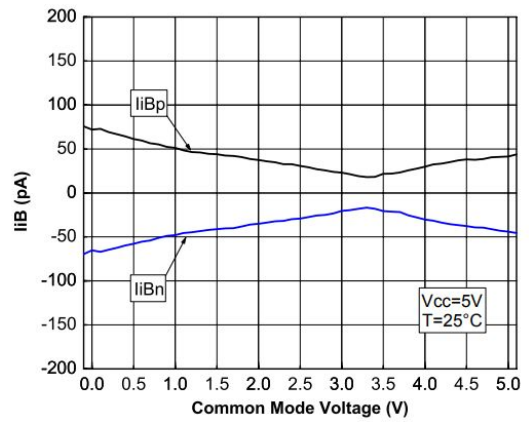

Figure 20. Input bias current vs. temp. at  $V_{CC} = 5\text{ V}$

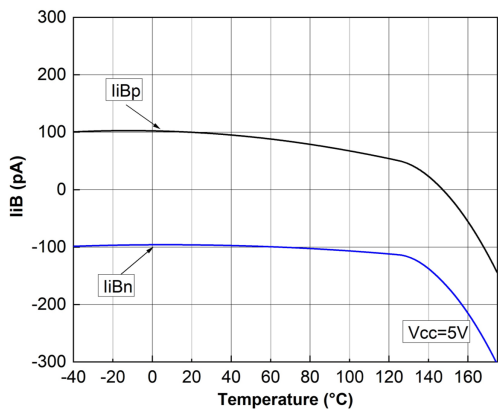

Figure 21. Output rail linearity

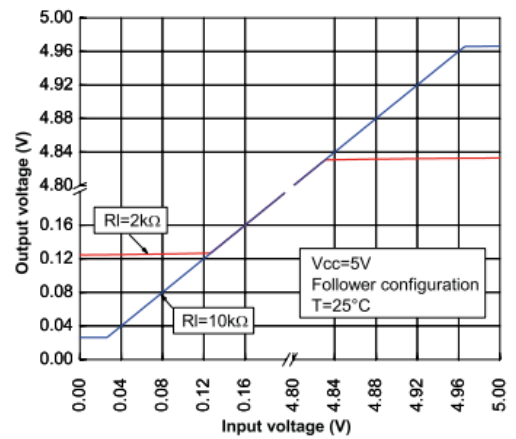

Figure 22. Bode diagram at  $V_{CC} = 5\text{ V}$

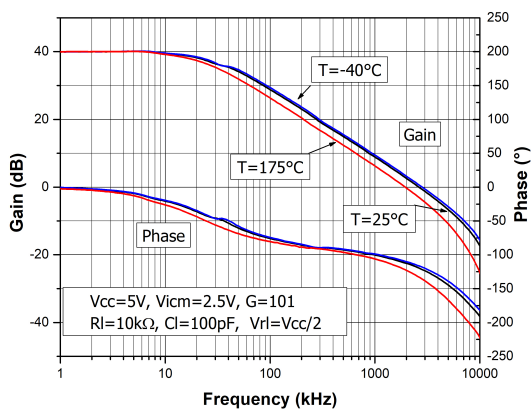

Figure 23. Bode diagram at  $V_{CC} = 2.2\text{ V}$

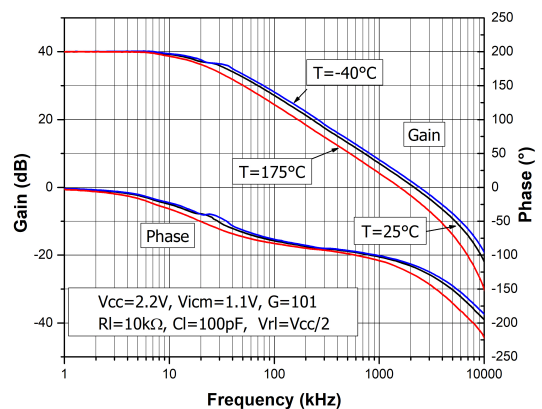

Figure 24. Bode diagram at  $V_{CC} = 3.3\text{ V}$

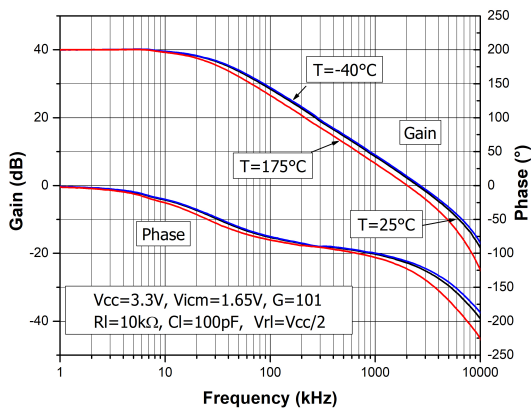

Figure 25. Open loop gain vs. frequency

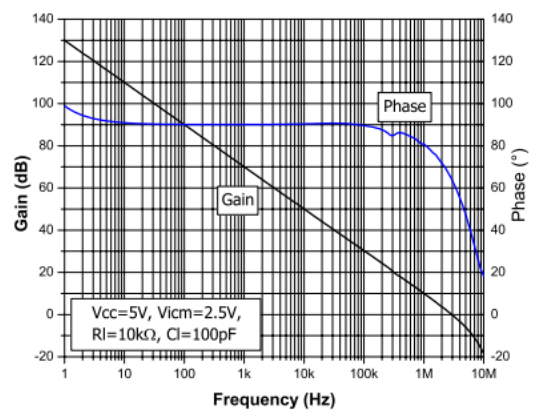

Figure 26. Positive slew rate vs. supply voltage

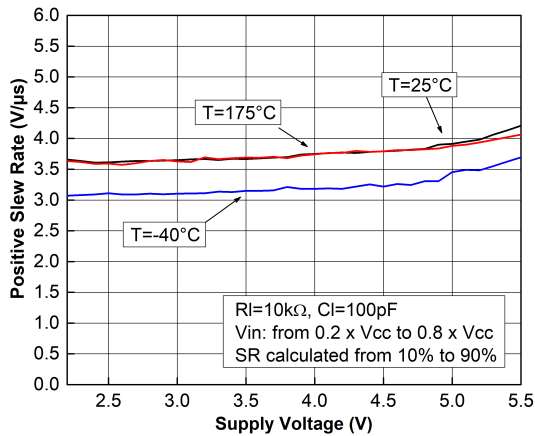

Figure 27. Negative slew rate vs. supply voltage

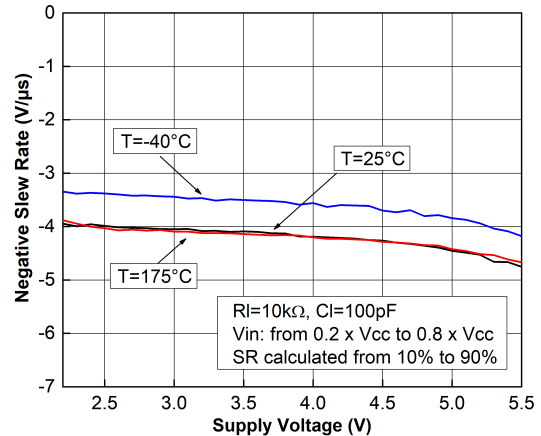

Figure 28. Noise 0.1 – 10 Hz vs. time

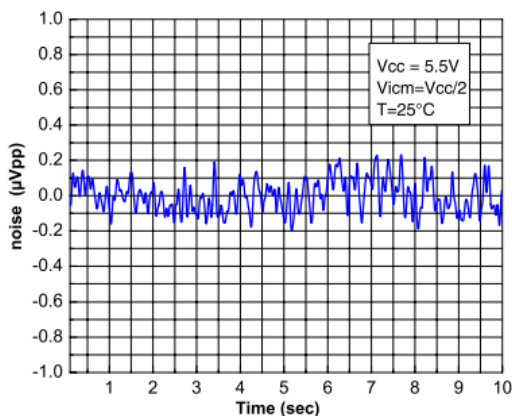

Figure 29. Noise vs. frequency

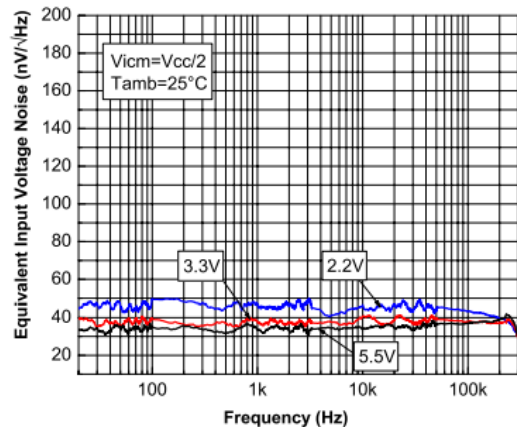

Figure 30. Output overshoot vs. load capacitance

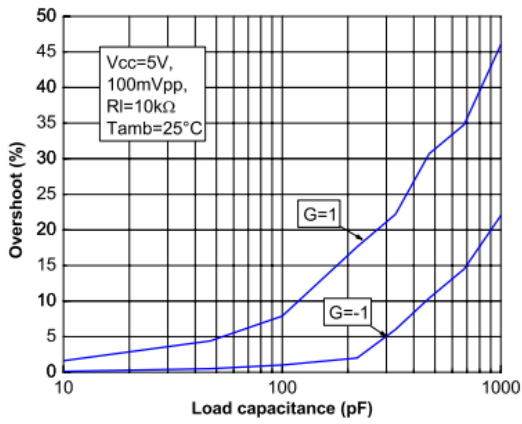

Figure 31. Small signal  $V_{CC} = 5 V$

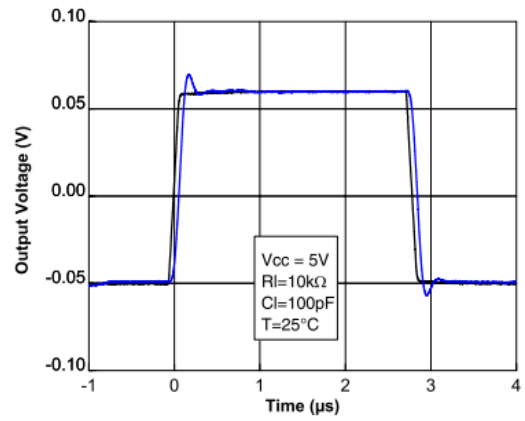

Figure 32. Small signal  $V_{CC} = 2.2 V$

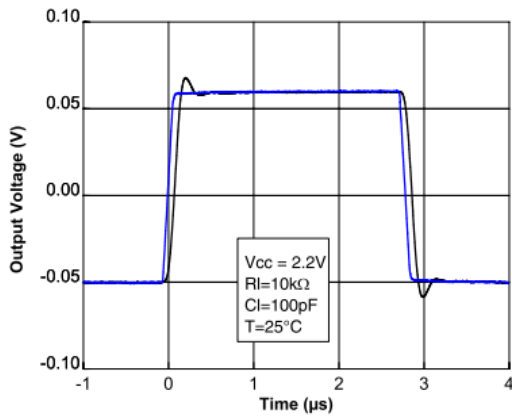

Figure 33. Large signal  $V_{CC} = 5 V$

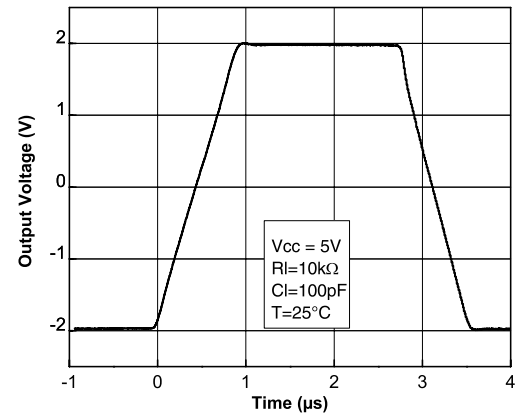

Figure 34. Large signal  $V_{CC} = 2.2 V$

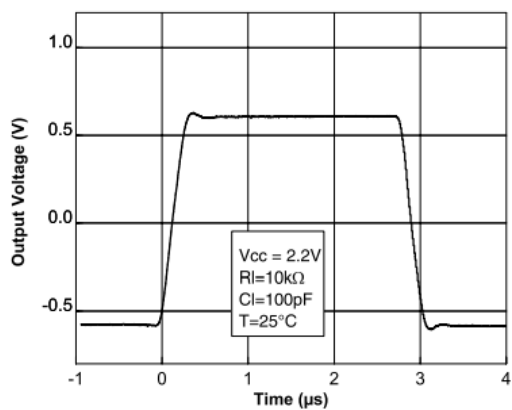

Figure 35. Negative overv. recovery  $V_{CC} = 2.2 V$

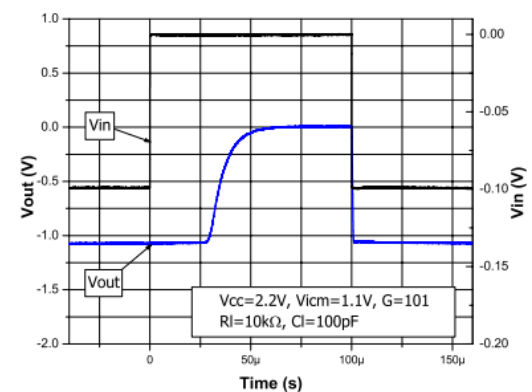

Figure 36. Positive overvoltage recovery  $V_{CC} = 5\text{ V}$

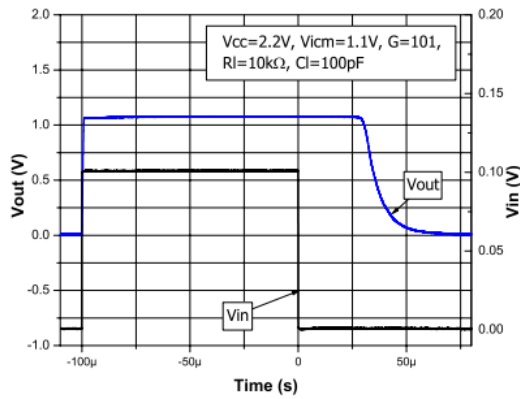

Figure 37. Output impedance vs. frequency

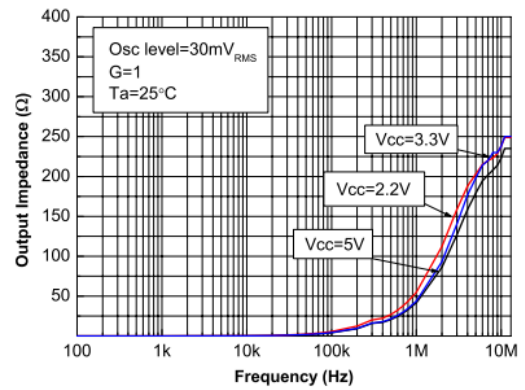

Figure 38. Settling time positive step (-2 V to 0 V)

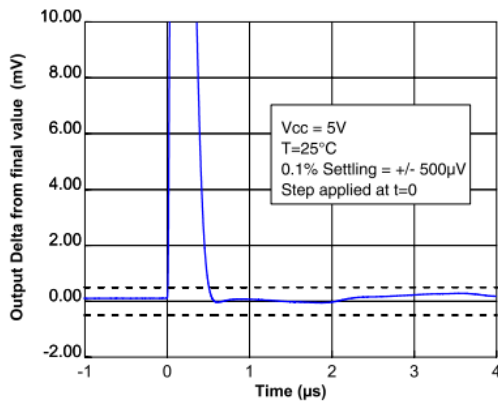

Figure 39. Settling time negative step (2 V to 0 V)

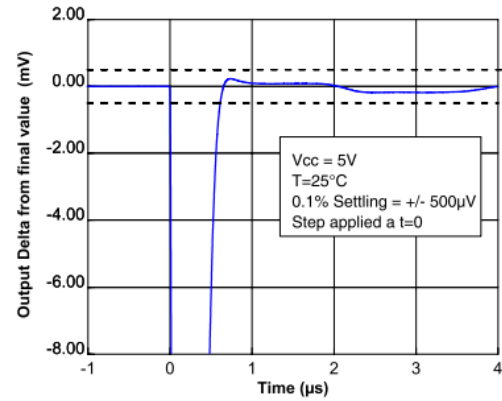

Figure 40. Settling time positive step (-0.8 V to 0 V)

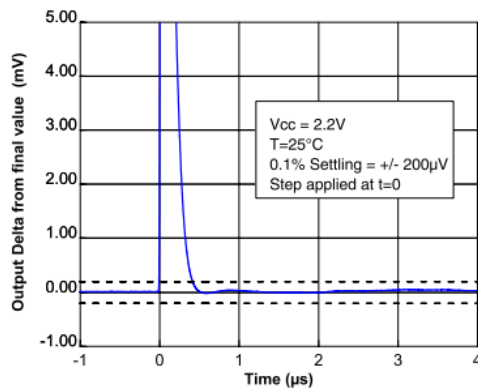

Figure 41. Settling time negative step (0.8 V to 0 V)

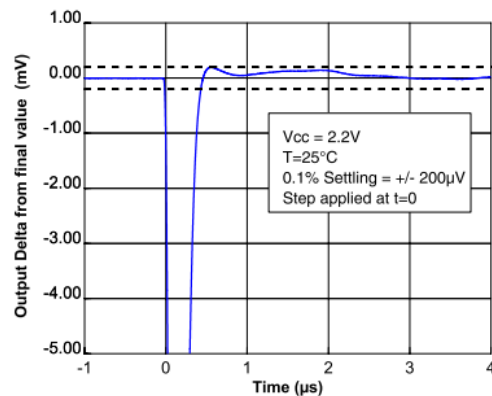



Figure 42. Maximum output voltage vs. frequency

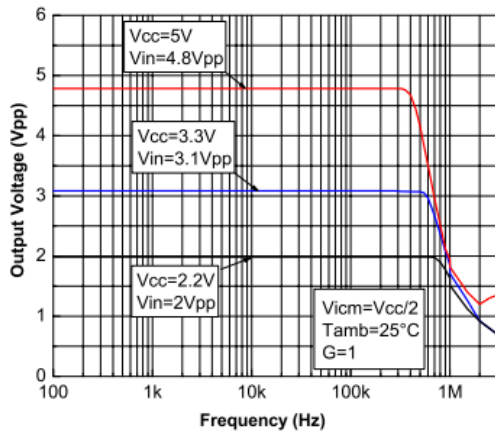

Figure 43. Crosstalk vs. frequency

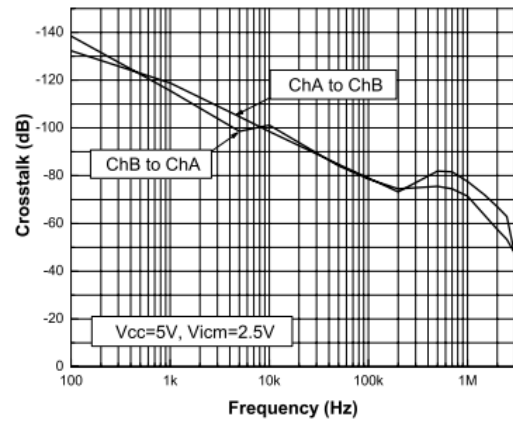
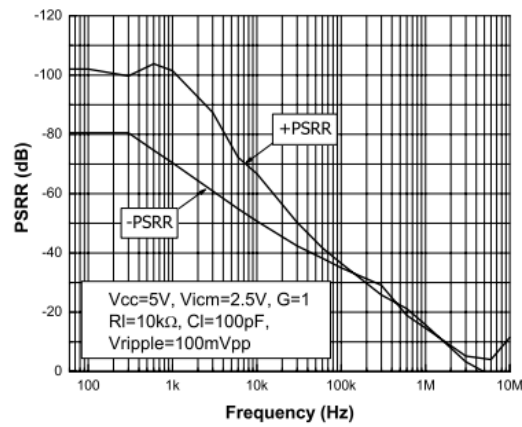

Figure 44. PSRR vs. frequency



## 5 Package information

---

In order to meet environmental requirements, ST offers these devices in different grades of **ECOPACK** packages, depending on their level of environmental compliance. ECOPACK specifications, grade definitions and product status are available at: [www.st.com](http://www.st.com). ECOPACK is an ST trademark.

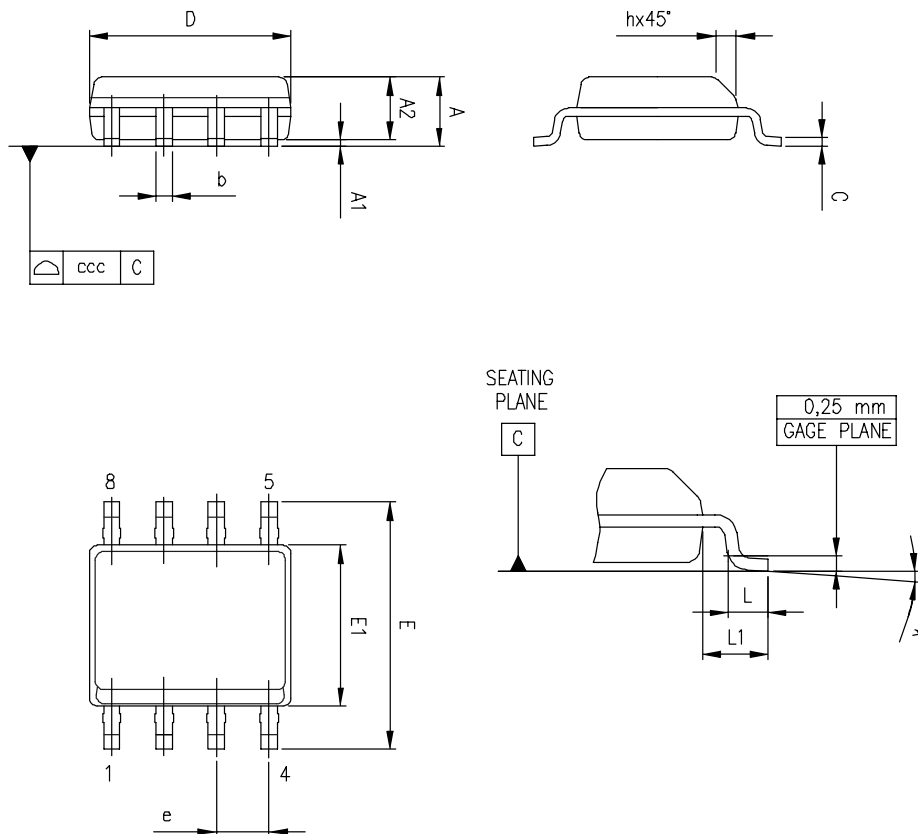
**5.1 SO8 package information**
**Figure 45. SO8 package outline**

**Table 6. SO8 mechanical data**

Dim.	mm			Inches		
	Min.	Typ.	Max.	Min.	Typ.	Max.
A			1.75			0.069
A1	0.1		0.25	0.004		0.01
A2	1.25			0.049		
b	0.28		0.48	0.011		0.019
c	0.17		0.23	0.007		0.01
D	4.8	4.9	5	0.189	0.193	0.197
E	5.8	6	6.2	0.228	0.236	0.244
E1	3.8	3.9	4	0.15	0.154	0.157
e		1.27			0.05	
h	0.25		0.5	0.01		0.02
L	0.4		1.27	0.016		0.05
L1		1.04			0.04	
k	0		8 °	1 °		8 °
ccc			0.1			0.004

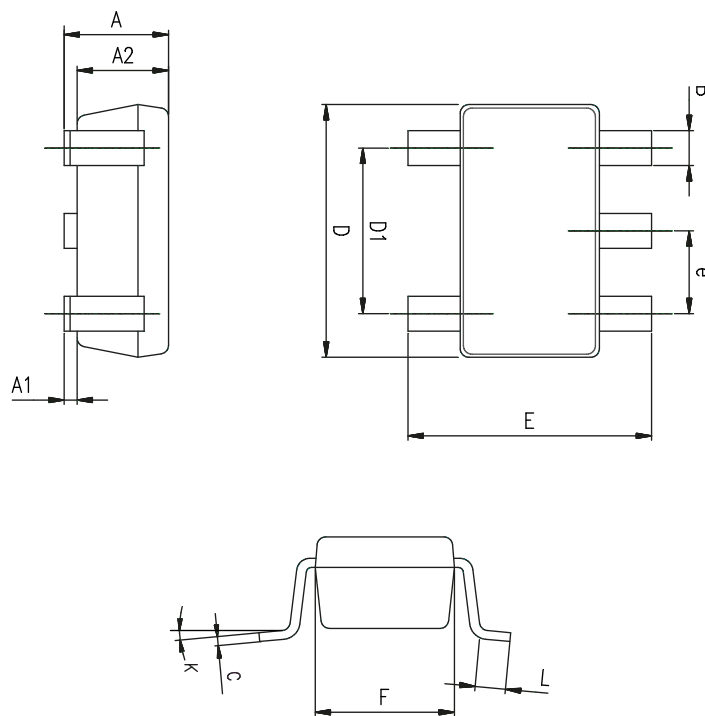
## 5.2 SOT23-5 package information

**Figure 46. SOT23-5 package outline**

**Table 7. SOT23-5 mechanical data**

Ref.	Dimensions					
	Millimeters			Inches		
	Min.	Typ.	Max.	Min.	Typ.	Max.
A	0.90	1.20	1.45	0.035	0.047	0.057
A1			0.15			0.006
A2	0.90	1.05	1.30	0.035	0.041	0.051
B	0.35	0.40	0.50	0.014	0.016	0.020
C	0.09	0.15	0.20	0.004	0.006	0.008
D	2.80	2.90	3.00	0.110	0.114	0.118
D1		1.90			0.075	
e		0.95			0.037	
E	2.60	2.80	3.00	0.102	0.110	0.118
F	1.50	1.60	1.75	0.059	0.063	0.069
L	0.10	0.35	0.60	0.004	0.014	0.024
K	0 degrees		10 degrees	0 degrees		10 degrees

## 6 Ordering information

**Table 8. Order code**

Order code	Package	Packaging	Marking
TSZ181H1YLT <sup>(1)</sup>	SOT23-5	Tape & Reel	K230
TSZ182H1YDT <sup>(1)</sup>	SO8	Tape & Reel	Z182H1Y

1. Qualified and characterized according to AEC Q100 and Q003 or equivalent, advanced screening according to AEC Q001 & Q002 or equivalent.

## Revision history

**Table 9. Document revision history**

Date	Revision	Changes
01-Mar-2021	1	Initial release.
17-Jan-2023	2	Added new TSZ181H1YLT part number in <a href="#">Table 8</a> . <a href="#">Order code</a> and new SOT23-5 package information. Updated title, figure, features and description on the cover page. Updated <a href="#">Figure 1</a> , <a href="#">Figure 3</a> , <a href="#">Figure 4</a> , <a href="#">Figure 5</a> , <a href="#">Figure 6</a> , <a href="#">Figure 7</a> , <a href="#">Figure 8</a> , <a href="#">Figure 9</a> and <a href="#">Figure 14</a> .

---

## Contents

<b>1</b>	<b>Pin connections</b> .....	<b>2</b>
<b>2</b>	<b>Absolute maximum ratings and operating conditions</b> .....	<b>3</b>
<b>3</b>	<b>Electrical characteristics</b> .....	<b>4</b>
<b>4</b>	<b>Typical performance characteristics</b> .....	<b>10</b>
<b>5</b>	<b>Package information</b> .....	<b>18</b>
<b>5.1</b>	SO8 package information .....	19
<b>5.2</b>	SOT23-5 package information .....	20
<b>6</b>	<b>Ordering information</b> .....	<b>21</b>
	<b>Revision history</b> .....	<b>22</b>

## List of tables

<b>Table 1.</b>	Absolute maximum ratings . . . . .	3
<b>Table 2.</b>	Operating conditions . . . . .	3
<b>Table 3.</b>	Electrical characteristics at $V_{cc+} = 2.2\text{ V}$ , $V_{cc-} = 0\text{ V}$ , $V_{icm} = V_{cc}/2$ , $T = 25\text{ }^{\circ}\text{C}$ , $R_L = 10\text{ k}\Omega$ connected to $V_{cc}/2$ (unless otherwise specified) . . . . .	4
<b>Table 4.</b>	Electrical characteristics at $V_{cc+} = 3.3\text{ V}$ , $V_{cc-} = 0\text{ V}$ , $V_{icm} = V_{cc}/2$ , $T = 25\text{ }^{\circ}\text{C}$ , $R_L = 10\text{ k}\Omega$ connected to $V_{cc}/2$ (unless otherwise specified) . . . . .	6
<b>Table 5.</b>	Electrical characteristics at $V_{cc+} = 5\text{ V}$ , $V_{cc-} = 0\text{ V}$ , $V_{icm} = V_{cc}/2$ , $T = 25\text{ }^{\circ}\text{C}$ , $R_L = 10\text{ k}\Omega$ connected to $V_{cc}/2$ (unless otherwise specified) . . . . .	8
<b>Table 6.</b>	SO8 mechanical data . . . . .	19
<b>Table 7.</b>	SOT23-5 mechanical data . . . . .	20
<b>Table 8.</b>	Order code . . . . .	21
<b>Table 9.</b>	Document revision history . . . . .	22



## List of figures

<b>Figure 1.</b>	Pin connections (top view) . . . . .	2
<b>Figure 2.</b>	Supply current vs. supply voltage . . . . .	10
<b>Figure 3.</b>	Input offset voltage distribution at $V_{CC} = 5\text{ V}$ . . . . .	10
<b>Figure 4.</b>	Input offset voltage distribution at $V_{CC} = 3.3\text{ V}$ . . . . .	10
<b>Figure 5.</b>	Input offset voltage distribution at $V_{CC} = 2.2\text{ V}$ . . . . .	10
<b>Figure 6.</b>	Input offset voltage distribution at $V_{CC} = 5\text{ V}$ , $T = 175\text{ }^{\circ}\text{C}$ . . . . .	11
<b>Figure 7.</b>	Input offset voltage distribution at $V_{CC} = 5\text{ V}$ , $T = -40\text{ }^{\circ}\text{C}$ . . . . .	11
<b>Figure 8.</b>	Input offset voltage distribution at $V_{CC} = 2.2\text{ V}$ , $T = 175\text{ }^{\circ}\text{C}$ . . . . .	11
<b>Figure 9.</b>	Input offset voltage distribution at $V_{CC} = 2.2\text{ V}$ , $T = -40\text{ }^{\circ}\text{C}$ . . . . .	11
<b>Figure 10.</b>	Input offset voltage vs. supply voltage . . . . .	11
<b>Figure 11.</b>	Input offset voltage vs. input common mode at $V_{CC} = 5.5\text{ V}$ . . . . .	11
<b>Figure 12.</b>	Input offset voltage vs. input common mode at $V_{CC} = 3.3\text{ V}$ . . . . .	12
<b>Figure 13.</b>	Input offset voltage vs. input common mode at $V_{CC} = 2.2\text{ V}$ . . . . .	12
<b>Figure 14.</b>	Input offset voltage vs. temperature . . . . .	12
<b>Figure 15.</b>	$V_{OH}$ vs. supply voltage . . . . .	12
<b>Figure 16.</b>	$V_{OL}$ vs. supply voltage . . . . .	12
<b>Figure 17.</b>	Output current vs. output voltage at $V_{CC} = 5\text{ V}$ . . . . .	12
<b>Figure 18.</b>	Output current vs. output voltage at $V_{CC} = 2.2\text{ V}$ . . . . .	13
<b>Figure 19.</b>	Input bias current vs. common-mode at $V_{CC} = 5\text{ V}$ . . . . .	13
<b>Figure 20.</b>	Input bias current vs. temp. at $V_{CC} = 5\text{ V}$ . . . . .	13
<b>Figure 21.</b>	Output rail linearity . . . . .	13
<b>Figure 22.</b>	Bode diagram at $V_{CC} = 5\text{ V}$ . . . . .	13
<b>Figure 23.</b>	Bode diagram at $V_{CC} = 2.2\text{ V}$ . . . . .	13
<b>Figure 24.</b>	Bode diagram at $V_{CC} = 3.3\text{ V}$ . . . . .	14
<b>Figure 25.</b>	Open loop gain vs. frequency . . . . .	14
<b>Figure 26.</b>	Positive slew rate vs. supply voltage . . . . .	14
<b>Figure 27.</b>	Negative slew rate vs. supply voltage . . . . .	14
<b>Figure 28.</b>	Noise 0.1 – 10 Hz vs. time . . . . .	14
<b>Figure 29.</b>	Noise vs. frequency . . . . .	14
<b>Figure 30.</b>	Output overshoot vs. load capacitance . . . . .	15
<b>Figure 31.</b>	Small signal $V_{CC} = 5\text{ V}$ . . . . .	15
<b>Figure 32.</b>	Small signal $V_{CC} = 2.2\text{ V}$ . . . . .	15
<b>Figure 33.</b>	Large signal $V_{CC} = 5\text{ V}$ . . . . .	15
<b>Figure 34.</b>	Large signal $V_{CC} = 2.2\text{ V}$ . . . . .	15
<b>Figure 35.</b>	Negative overv. recovery $V_{CC} = 2.2\text{ V}$ . . . . .	15
<b>Figure 36.</b>	Positive overvoltage recovery $V_{CC} = 5\text{ V}$ . . . . .	16
<b>Figure 37.</b>	Output impedance vs. frequency . . . . .	16
<b>Figure 38.</b>	Settling time positive step (-2 V to 0 V) . . . . .	16
<b>Figure 39.</b>	Settling time negative step (2 V to 0 V) . . . . .	16
<b>Figure 40.</b>	Settling time positive step (-0.8 V to 0 V) . . . . .	16
<b>Figure 41.</b>	Settling time negative step (0.8 V to 0 V) . . . . .	16
<b>Figure 42.</b>	Maximum output voltage vs. frequency . . . . .	17
<b>Figure 43.</b>	Crosstalk vs. frequency . . . . .	17
<b>Figure 44.</b>	PSSR vs. frequency . . . . .	17
<b>Figure 45.</b>	SO8 package outline . . . . .	19
<b>Figure 46.</b>	SOT23-5 package outline . . . . .	20