

Technische Information / technical information



Netz-Thyristor-Modul
Phase Control Thyristor Module

TT120N16SOF

Infineon Technologies Bipolar
GmbH & Co. KG

Key Parameters

V_{DRM} / V_{RRM}	1600 V
I_{TAVM}	120 A ($T_C=85\text{ °C}$)
I_{TSM}	2250 A
V_{T0}	0,9 V
r_T	3,35 m Ω
R_{thJC}	0,19 K/W
Base plate	20 mm
Weight	75 g



For type designation please refer to actual short form catalog

<http://www.ifbip.com/catalog>

Merkmale

- Löt-Löt Technologie
- Industrie-Standard-Gehäuse
- Elektrisch isolierte Bodenplatte

Features

- Solder-Solder Technology
- Industrial standard package
- Electrically insulated base plate

Typische Anwendungen

- Sanftanlasser
- Gleichrichter für Antriebsapplikationen
- Leistungssteller
- Gleichrichter für UPS
- Batterieladegleichrichter
- Statische Umschalter

Typical Applications

- Soft starter
- Rectifier for drives applications
- Power controllers
- Rectifiers for UPS
- Battery chargers
- Static switches

content of customer DMX code	DMX code digit	DMX code digit quantity
type designation	1..18	18
serial number	19..23	5
internal production order number	24..31	8
material number	32..41	10
date code (YY/WW)	42..45	4
add on for date code	46	1

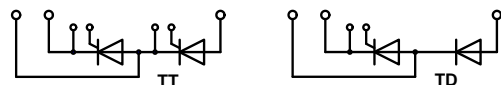

www.ifbip.com
support@infineon-bip.com



Technische Information / technical information



Netz-Thyristor-Modul
Phase Control Thyristor Module

TT120N16SOF

Infineon Technologies Bipolar
GmbH & Co. KG

TT120N16SOF TT120N16SOFB01
TD120N16SOF

Elektrische Eigenschaften / Electrical properties

Höchstzulässige Werte / Maximum rated values

Periodische Vorwärts- und Rückwärts-Spitzensperrspannung repetitive peak forward off-state and reverse voltages	$T_{vj} = -40^{\circ}\text{C} \dots T_{vj\text{max}}$	$V_{\text{DRM}}, V_{\text{RRM}}$	1600	V
Vorwärts-Stoßspitzensperrspannung non-repetitive peak forward off-state voltage	$T_{vj} = -40^{\circ}\text{C} \dots T_{vj\text{max}}$	V_{DSM}	1600	V
Rückwärts-Stoßspitzensperrspannung non-repetitive peak reverse voltage	$T_{vj} = +25^{\circ}\text{C} \dots T_{vj\text{max}}$	V_{RSM}	1700	V
Durchlaßstrom-Grenzeffektivwert maximum RMS on-state current		I_{TRMSM}	190	A
Dauergrenzstrom average on-state current	$T_{\text{C}} = 85^{\circ}\text{C}$	I_{TAVM}	119	A
Stoßstrom-Grenzwert surge current	$T_{vj} = 25^{\circ}\text{C}, t_{\text{P}} = 10\text{ms}$	I_{TSM}	2250	A
Grenzlastintegral I^2t -value	$T_{vj} = 25^{\circ}\text{C}, t_{\text{P}} = 10\text{ms}$	I^2t	25313	A^2s
Kritische Stromsteilheit critical rate of rise of on-state current	DIN IEC 60747-6 $f = 50\text{Hz}, i_{\text{GM}} = 1\text{A}, di_{\text{G}}/dt = 1\text{A}/\mu\text{s}$	$(di_{\text{T}}/dt)_{\text{cr}}$	140	$\text{A}/\mu\text{s}$
Kritische Spannungssteilheit critical rate of rise of off-state voltage	$T_{vj} = T_{vj\text{max}}, V_{\text{D}} = 0,67 V_{\text{DRM}}$ 6. Kennbuchstabe / 6 th letter F	$(dv_{\text{D}}/dt)_{\text{cr}}$	1000	$\text{V}/\mu\text{s}$

Charakteristische Werte / Characteristic values

Durchlaßspannung on-state voltage	$T_{vj} = 25^{\circ}\text{C} \quad i_{\text{T}} = 300\text{A}$	V_{T}	max. 1,75	V
Schleusenspannung threshold voltage	$T_{vj} = T_{vj\text{max}}$	$V_{(\text{TO})}$	max. 0,9	V
Ersatzwiderstand slope resistance	$T_{vj} = T_{vj\text{max}}$	r_{T}	max. 3,35	$\text{m}\Omega$
Zündstrom gate trigger current	$T_{vj} = 25^{\circ}\text{C}, V_{\text{D}} = 12\text{V}$	I_{GT}	max. 100	mA
Zündspannung gate trigger voltage	$T_{vj} = 25^{\circ}\text{C}, V_{\text{D}} = 12\text{V}$	V_{GT}	max. 2,5	V
Nicht zündender Steuerstrom gate non-trigger current	$T_{vj} = T_{vj\text{max}}, V_{\text{D}} = 12\text{V}$ $T_{vj} = T_{vj\text{max}}, V_{\text{D}} = 0,5 V_{\text{DRM}}$	I_{GD}	max. 4 max. 2	mA mA
Nicht zündende Steuerspannung gate non-trigger voltage	$T_{vj} = T_{vj\text{max}}, V_{\text{D}} = 0,5 V_{\text{DRM}}$	V_{GD}	max. 0,25	V
Haltestrom holding current	$T_{vj} = 25^{\circ}\text{C}, V_{\text{D}} = 12\text{V}, R_{\text{A}} = 1\Omega$	I_{H}	max. 250	mA
Einraststrom latching current	$T_{vj} = 25^{\circ}\text{C}, V_{\text{D}} = 12\text{V}, R_{\text{GK}} \geq 10\Omega$ $i_{\text{GM}} = 1\text{A}, di_{\text{G}}/dt = 1\text{A}/\mu\text{s}, t_{\text{g}} = 20\mu\text{s}$	I_{L}	max. 600	mA
Vorwärts- und Rückwärts-Sperrstrom forward off-state and reverse current	$T_{vj} = T_{vj\text{max}}$ $V_{\text{D}} = V_{\text{DRM}}, V_{\text{R}} = V_{\text{RRM}}$	$i_{\text{D}}, i_{\text{R}}$	max. 20	mA
Zündverzug gate controlled delay time	DIN IEC 60747-6 $T_{vj} = 25^{\circ}\text{C}, i_{\text{GM}} = 1\text{A}, di_{\text{G}}/dt = 1\text{A}/\mu\text{s}$	t_{gd}	max. 1	μs

prepared by: AG		date of publication: 2017-08-23
approved by: MS		revision: 3.5



Technische Information / technical information



Netz-Thyristor-Modul
Phase Control Thyristor Module

TT120N16SOF

Infineon Technologies Bipolar
GmbH & Co. KG

Elektrische Eigenschaften / Electrical properties

Charakteristische Werte / Characteristic values

Freiwerdezeit circuit commutated turn-off time	$T_{vj} = T_{vj\max}$, $i_{TM} = I_{TAVM}$ $V_{RM} = 100\text{ V}$, $v_{DM} = 0,67\text{ V}_{DRM}$ $dv_D/dt = 20\text{ V}/\mu\text{s}$, $-di_T/dt = 10\text{ A}/\mu\text{s}$ 5.Kennbuchstabe / 5 th letter O	t_q	typ.	200	μs
Isolations-Prüfspannung insulation test voltage	RMS, $f = 50\text{ Hz}$, $t = 1\text{ min}$ RMS, $f = 50\text{ Hz}$, $t = 1\text{ sec}$	V_{ISOL}		3,0 3,6	kV kV

Thermische Eigenschaften / Thermal properties

Innerer Wärmewiderstand thermal resistance, junction to case	pro Modul / per Module, $\Theta = 180^\circ\text{ sin}$ pro Zweig / per arm, $\Theta = 180^\circ\text{ sin}$ pro Modul / per Module, DC pro Zweig / per arm, DC	R_{thJC}	max.	0,100	K/W
			max.	0,200	K/W
			max.	0,095	K/W
			max.	0,190	K/W
Übergangs-Wärmewiderstand thermal resistance, case to heatsink	pro Modul / per Module pro Zweig / per arm	R_{thCH}	max.	0,11	K/W
			max.	0,22	K/W
Höchstzulässige Sperrschichttemperatur maximum junction temperature		$T_{vj\max}$		130	$^\circ\text{C}$
Betriebstemperatur operating temperature		$T_{c\text{ op}}$		-40...+125	$^\circ\text{C}$
Lagertemperatur storage temperature		T_{stg}		-40...+125	$^\circ\text{C}$

Mechanische Eigenschaften / Mechanical properties

Gehäuse, siehe Anlage case, see annex				Seite 4 page 4	
Innere Isolation internal insulation	Basisisolierung (Schutzklasse 1, EN61140) Basic insulation (class 1, IEC61140)			Al_2O_3	
Anzugsdrehmoment für mechanische Anschlüsse mounting torque	Toleranz / Tolerance $\pm 15\%$	M1		5	Nm
Anzugsdrehmoment für elektrische Anschlüsse terminal connection torque	Toleranz / Tolerance $\pm 15\%$	M2		3	Nm
Steueranschlüsse control terminals	DIN 46 244			A 2,8 x 0,8	
Gewicht weight		G	typ.	75	g
Kriechstrecke creepage distance					mm
Schwingfestigkeit vibration resistance	$f = 50\text{ Hz}$			50	m/s^2
	file-No.			E 83336	

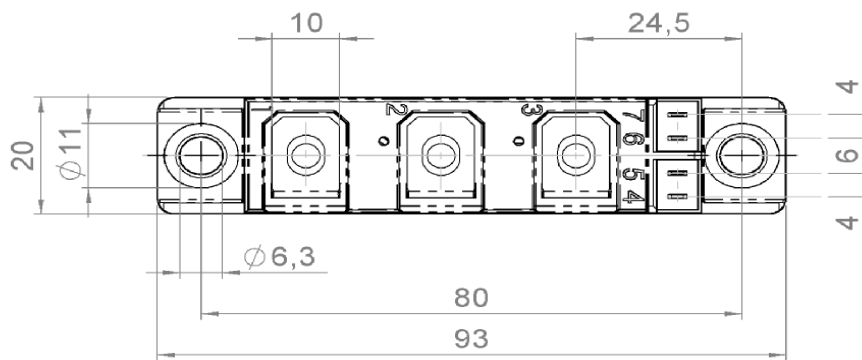
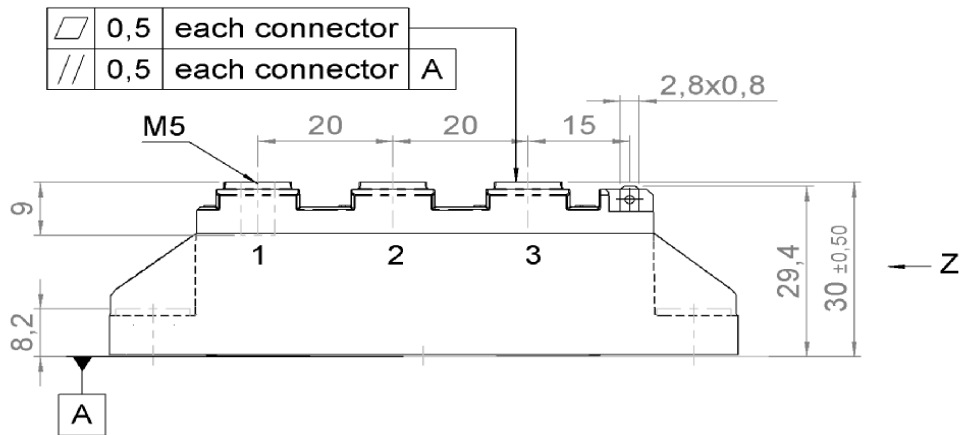
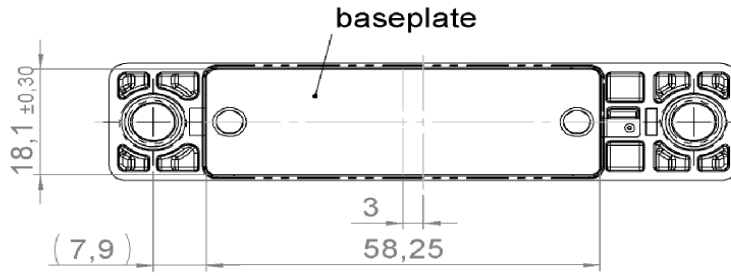
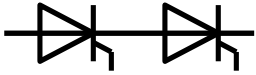

general tolerance
ISO 286 T1 / IT12

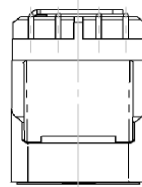

Z, M1:1

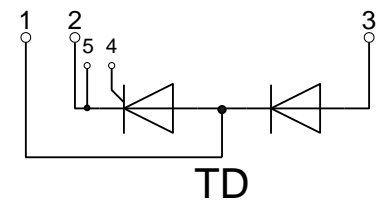
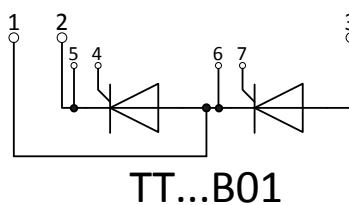
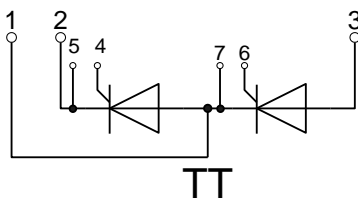



Technische Information /
technical information



Netz-Thyristor-Modul
Phase Control Thyristor Module

TT120N16SOF

Infineon Technologies Bipolar
GmbH & Co. KG

Analytische Elemente des transienten Wärmewiderstandes Z_{thJC} für DC
Analytical elements of transient thermal impedance Z_{thJC} for DC

Pos. n	1	2	3	4	5	6	7
R_{thn} [K/W]	0,0724	0,07	0,047				
τ_n [s]	0,198	0,031	0,0009				

Analytische Funktion / Analytical function:

$$Z_{thJC} = \sum_{n=1}^{n_{max}} R_{thn} \left(1 - e^{-\frac{t}{\tau_n}} \right)$$

Erhöhung des Z_{thDC} bei Sinus und Rechteckströmen mit unterschiedlichen Stromflusswinkeln Θ
Rise of Z_{thDC} for sinewave and rectangular current with different current conduction angles Θ
 $\Delta Z_{th \Theta rec} / \Delta Z_{th \Theta sin}$

	$\Theta = 180^\circ$	$\Theta = 120^\circ$	$\Theta = 90^\circ$	$\Theta = 60^\circ$	$\Theta = 30^\circ$
$\Delta Z_{th \Theta rec}$ [K/W]	0,06002	0,11199	0,16077	0,25145	0,45442
$\Delta Z_{th \Theta sin}$ [K/W]	0,00453	0,02005	0,04754	0,11481	0,31446

$$Z_{th \Theta rec} = Z_{thDC} + \Delta Z_{th \Theta rec}$$

$$Z_{th \Theta sin} = Z_{thDC} + \Delta Z_{th \Theta sin}$$

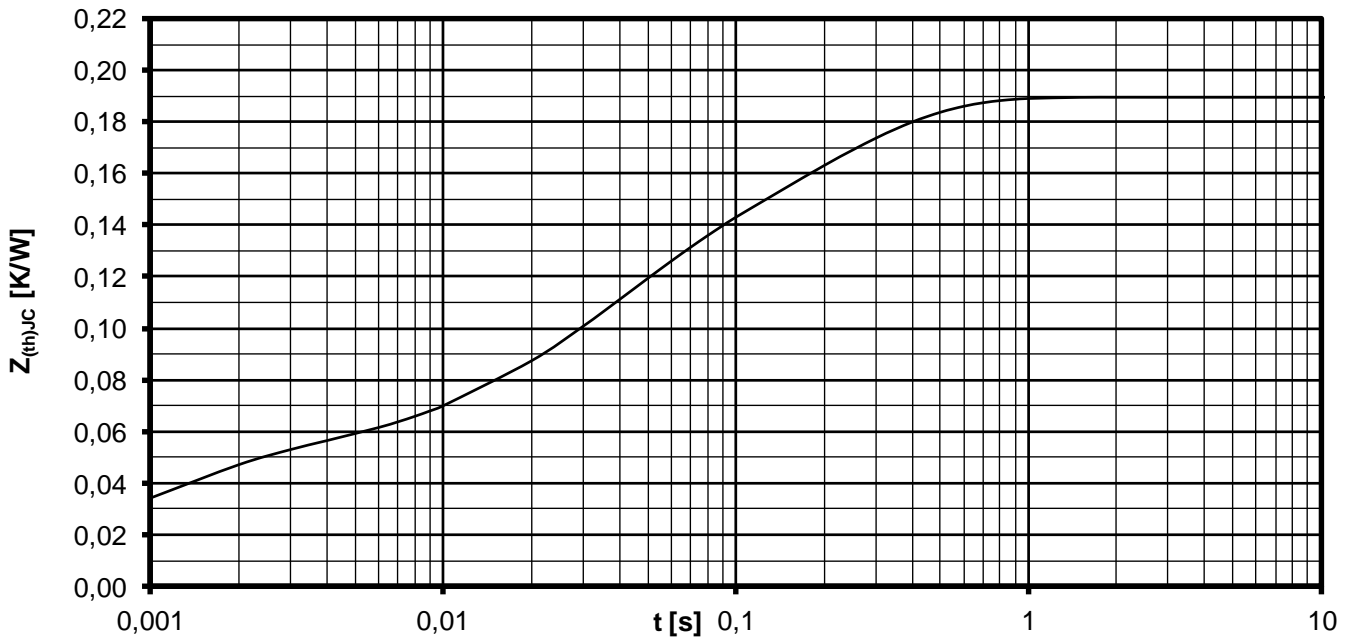

Transienter innerer Wärmewiderstand je Zweig / Transient thermal impedance per arm $Z_{thJC} = f(t)$

Parameter: Stromflußwinkel Θ / Current conduction angle Θ

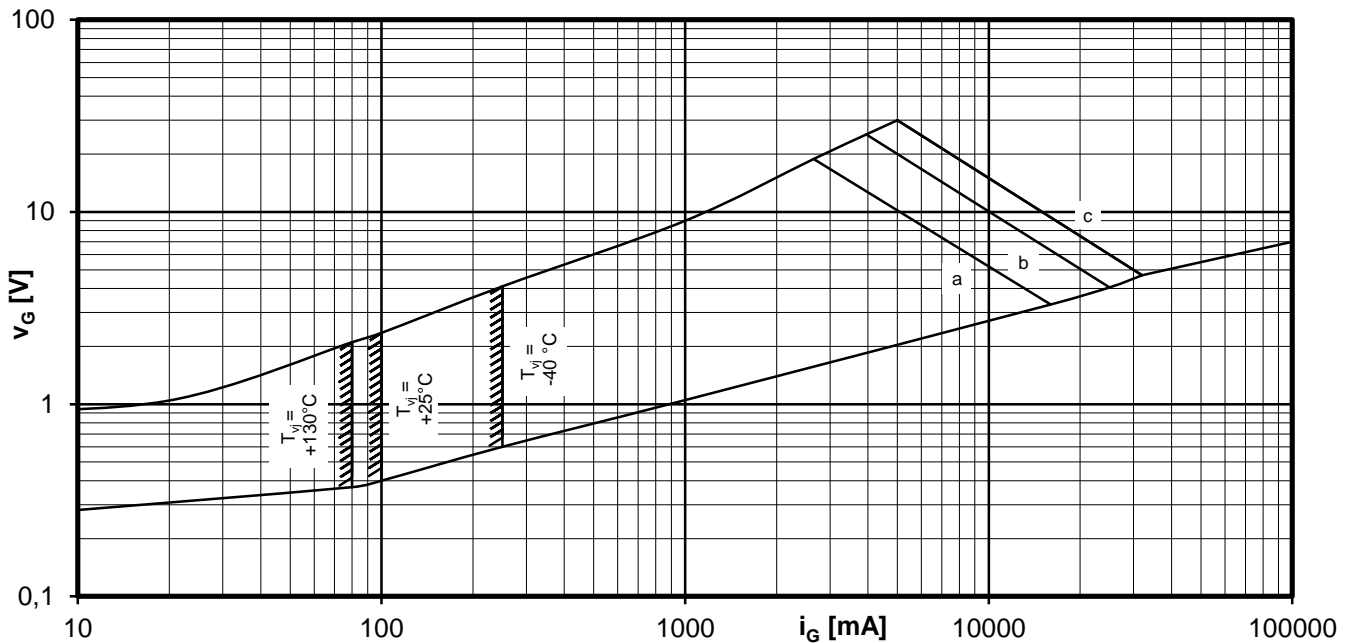

Steuercharakteristik $v_G = f(i_G)$ mit Zündbereichen für $V_D = 12\text{ V}$
Gate characteristic $v_G = f(i_G)$ with triggering area for $V_D = 12\text{ V}$

Höchstzulässige Spitzensteuerverlustleistung / Maximum rated peak gate power dissipation $P_{GM} = f(t_g)$:

a - 50W/8ms b - 100W/0,5ms c - 150W/0,1ms

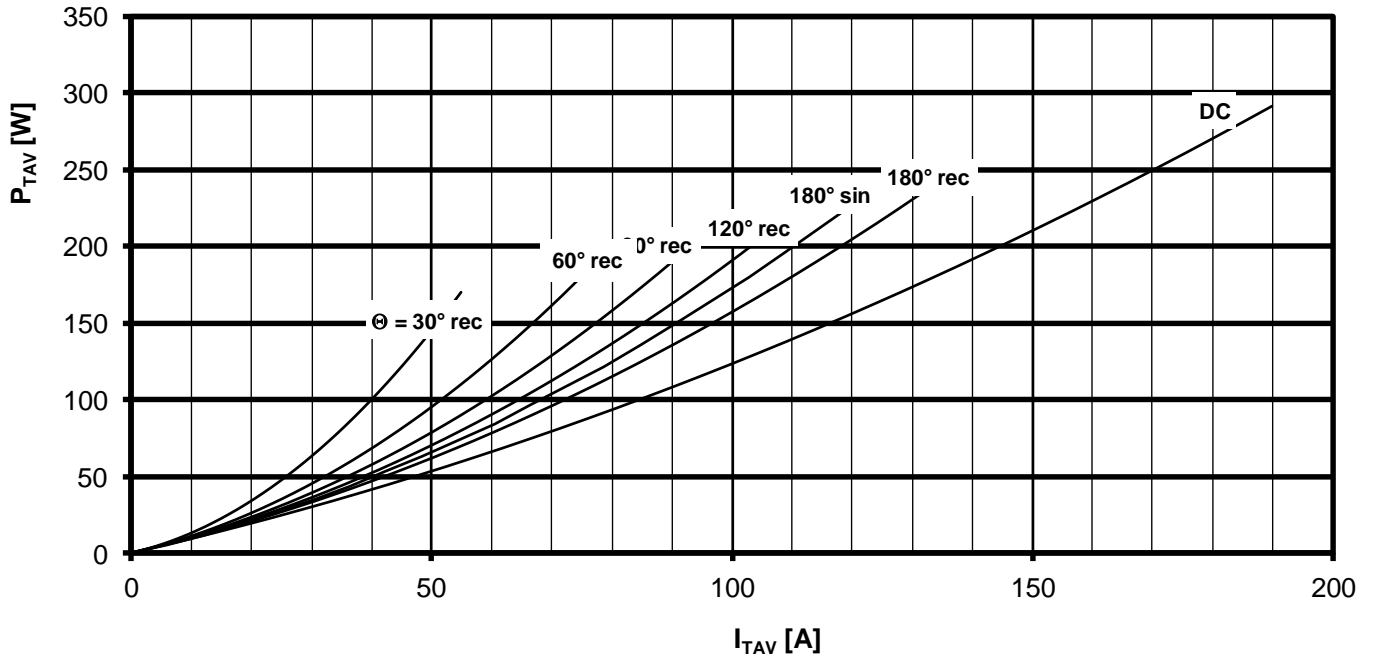

Durchlassverlustleistung je Zweig / On-state power loss per arm $P_{TAV} = f(I_{TAV})$

Strombelastung je Zweig / Current load per arm

Berechnungsgrundlage P_{TAV} (Schaltverluste gesondert berücksichtigen)
Calculation base P_{TAV} (switching losses should be considered separately)

Parameter: Stromflußwinkel / Current conduction angle Θ

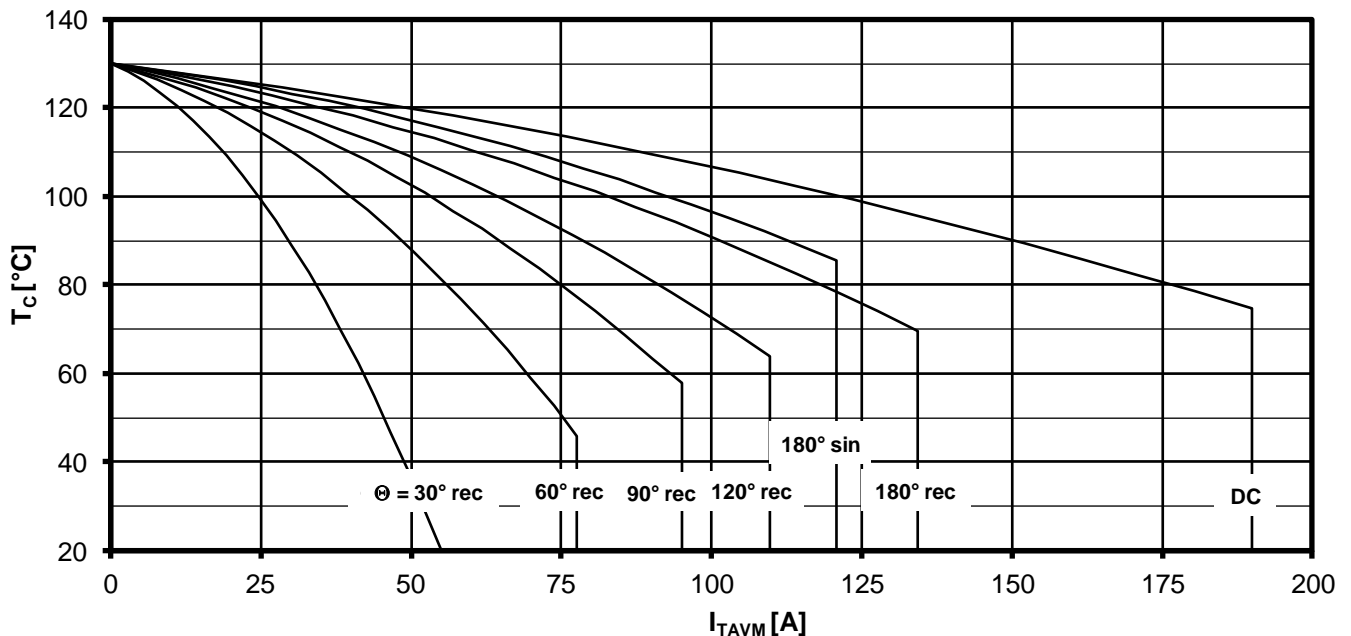

Höchstzulässige Gehäusetemperatur / Maximum allowable case temperature $T_c = f(I_{TAVM})$

Strombelastung je Zweig / Current load per arm

Berechnungsgrundlage P_{TAV} (Schaltverluste gesondert berücksichtigen)
Calculation base P_{TAV} (switching losses should be considered separately)

Parameter: Stromflußwinkel Θ / Current conduction angle Θ

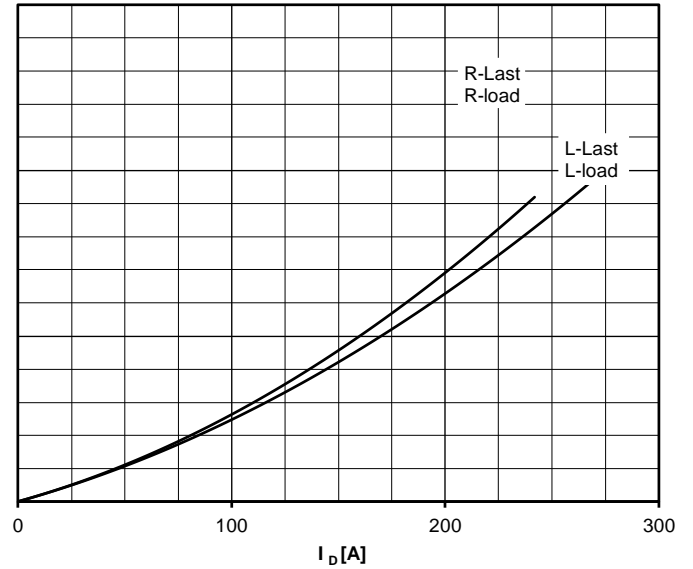
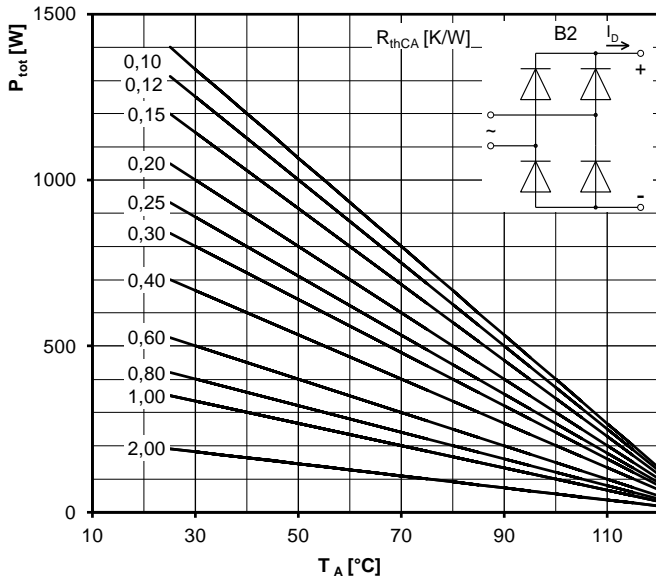

Höchstzulässiger Ausgangsstrom / Maximum rated output current I_D

B2- Zweipuls-Brückenschaltung / Two-pulse bridge circuit

Gesamtverlustleistung der Schaltung / Total power dissipation at circuit P_{tot}

Parameter:

Wärmewiderstand pro Element zwischen den Gehäusen und Umgebung /
Thermal resistance per chip cases to ambient R_{thCA}

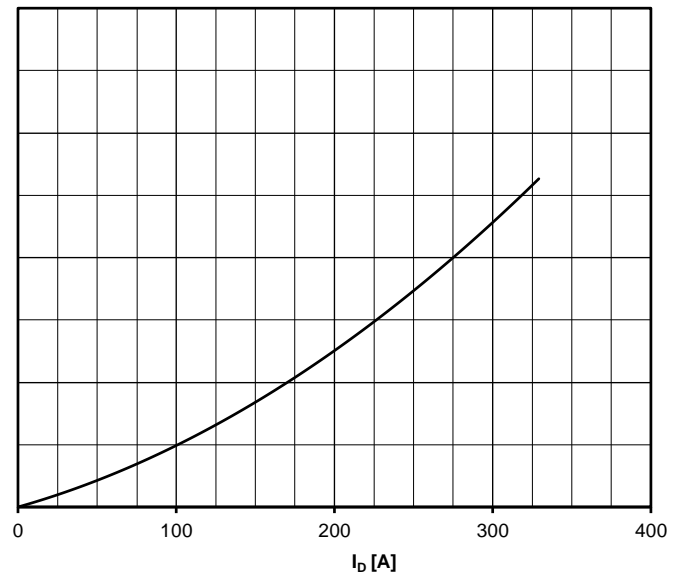
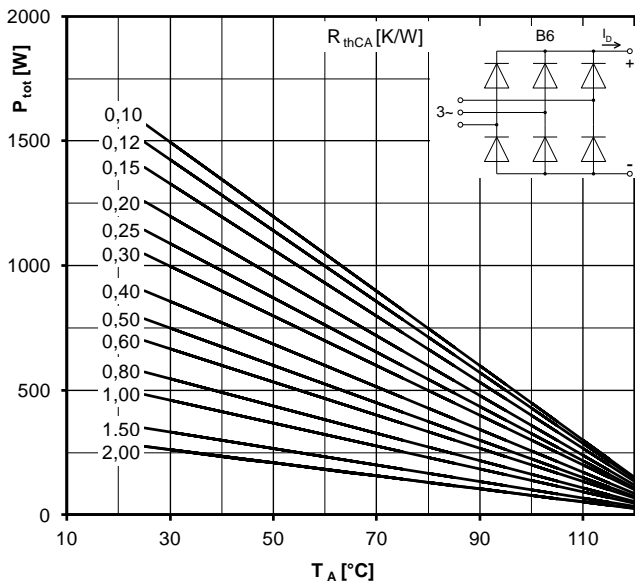

Höchstzulässiger Ausgangsstrom / Maximum rated output current I_D

B6- Sechspuls-Brückenschaltung / Six-pulse bridge circuit

Gesamtverlustleistung der Schaltung / Total power dissipation at circuit P_{tot}

Parameter:

Wärmewiderstand pro Element zwischen den Gehäusen und Umgebung /
Thermal resistance per chip cases to ambient R_{thCA}

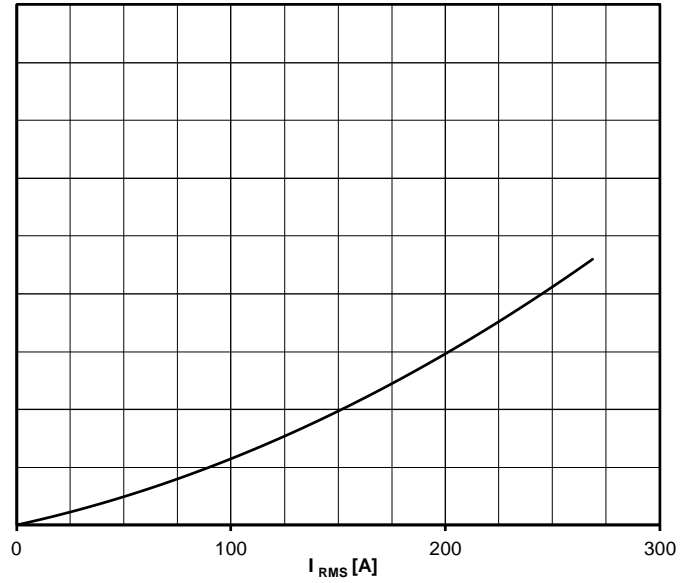
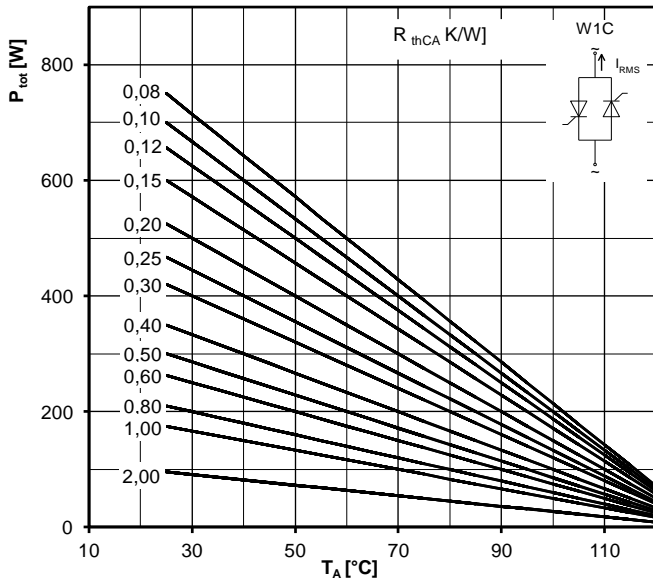

Höchstzulässiger Effektivstrom / Maximum rated RMS current I_{RMS}

W1C - Einphasen-Wechselwegschaltung / Single-phase inverse parallel circuit

Gesamtverlustleistung der Schaltung / Total power dissipation at circuit P_{tot}

Parameter:

Wärmewiderstand pro Element zwischen den Gehäusen und Umgebung /
Thermal resistance per chip cases to ambient R_{thCA}

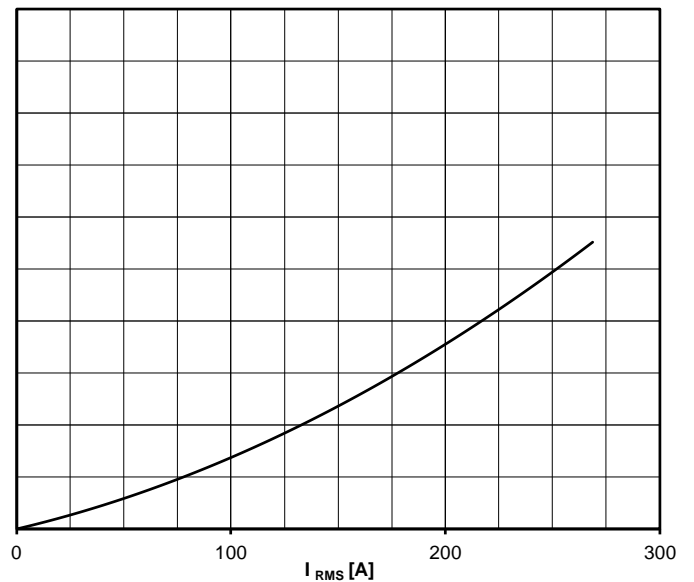
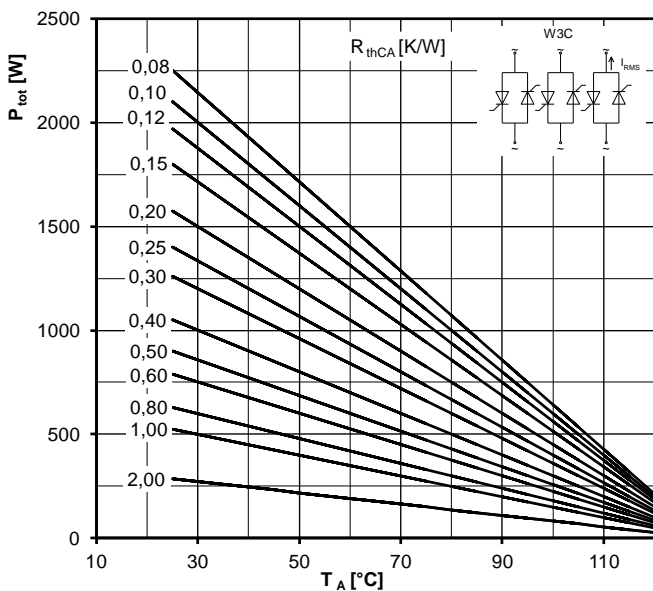

Höchstzulässiger Effektivstrom / Maximum rated RMS current I_{RMS}

W3C - Dreiphasen-Wechselwegschaltung / Three-phase inverse parallel circuit

Gesamtverlustleistung der Schaltung / Total power dissipation at circuit P_{tot}

Parameter:

Wärmewiderstand pro Element zwischen den Gehäusen und Umgebung /
Thermal resistance per chip cases to ambient R_{thCA}



Sperrverzögerungsladung / Recovered charge $Q_r = f(-di/dt)$

$$T_{vj} = T_{vjmax}, v_R \leq 0,5 V_{RRM}, v_{RM} = 0,8 V_{RRM}$$

Parameter: Durchlaßstrom / On-state current i_{TM}

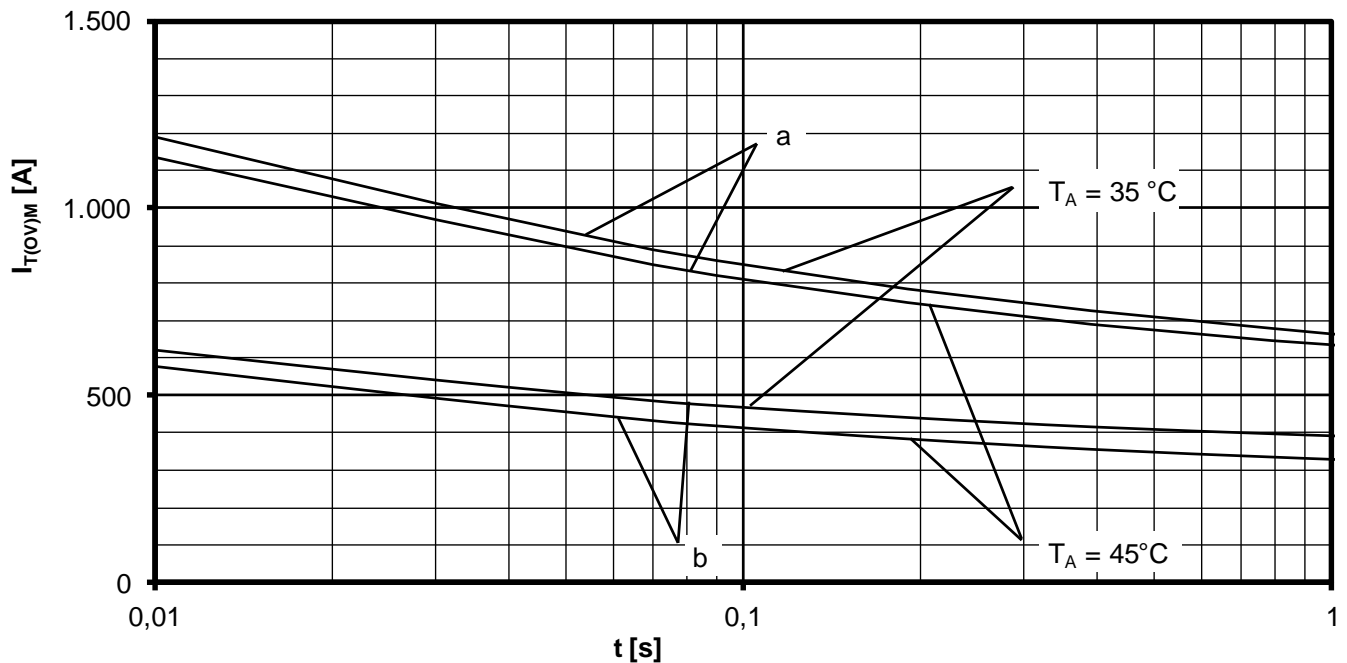

Grenzstrom / Maximum overload on-state current $I_{T(OV)M} = f(t), v_{RM} = 0,8 V_{RRM}$

a: Leerlauf / No-load conditions

b: nach Belastung mit I_{TAVM} / after load with I_{TAVM}

$T_A = 35^\circ\text{C}$, verstärkte Luftkühlung / Forced air cooling

$T_A = 45^\circ\text{C}$, Luftselbstkühlung / Natural air cooling