

Datenblatt / Data sheet



Netz-Thyristor-Modul
Phase Control Thyristor Module

TT140N

Infineon Technologies Bipolar
GmbH & Co. KG

TT140N

TD140N

TD140N..._TIM

Elektrische Eigenschaften / Electrical properties

Höchstzulässige Werte / Maximum rated values

Periodische Vorwärts- und Rückwärts-Spitzensperrspannung repetitive peak forward off-state and reverse voltages	$T_{vj} = -40^{\circ}\text{C} \dots T_{vj \max}$	$V_{\text{DRM}}, V_{\text{RRM}}$	1800	2000 2200	V V
Vorwärts-Stoßspitzensperrspannung non-repetitive peak forward off-state voltage	$T_{vj} = -40^{\circ}\text{C} \dots T_{vj \max}$	V_{DSM}	1800	2000 2200	V V
Rückwärts-Stoßspitzensperrspannung non-repetitive peak reverse voltage	$T_{vj} = +25^{\circ}\text{C} \dots T_{vj \max}$	V_{RSM}	1900	2100 2300	V V
Durchlaßstrom-Grenzeffektivwert maximum RMS on-state current		I_{TRMSM}		250	A
Dauergrenzstrom average on-state current	$T_{\text{C}} = 85^{\circ}\text{C}$ $T_{\text{C}} = 77^{\circ}\text{C}$	I_{TAVM}		140 159	A A
Stoßstrom-Grenzwert surge current	$T_{vj} = 25^{\circ}\text{C}, t_p = 10 \text{ ms}$ $T_{vj} = T_{vj \max}, t_p = 10 \text{ ms}$	I_{TSM}		4000 3200	A A
Grenzlastintegral I^2t -value	$T_{vj} = 25^{\circ}\text{C}, t_p = 10 \text{ ms}$ $T_{vj} = T_{vj \max}, t_p = 10 \text{ ms}$	I^2t		80000 51200	A^2s A^2s
Kritische Stromsteilheit critical rate of rise of on-state current	DIN IEC 747-6 $f = 50 \text{ Hz}$, $i_{\text{GM}} = 0,6 \text{ A}, di_{\text{G}}/dt = 0,6 \text{ A}/\mu\text{s}$	$(di_{\text{T}}/dt)_{\text{cr}}$		150	$\text{A}/\mu\text{s}$
Kritische Spannungssteilheit critical rate of rise of off-state voltage	$T_{vj} = T_{vj \max}, v_{\text{D}} = 0,67 V_{\text{DRM}}$ 6.Kennbuchstabe / 6 th letter F	$(dv_{\text{D}}/dt)_{\text{cr}}$		1000	$\text{V}/\mu\text{s}$

Charakteristische Werte / Characteristic values

Durchlaßspannung on-state voltage	$T_{vj} = T_{vj \max}, i_{\text{T}} = 500 \text{ A}$	v_{T}	max.	1,84	V
Schleusenspannung threshold voltage	$T_{vj} = T_{vj \max}$	$V_{(\text{TO})}$		0,9	V
Ersatzwiderstand slope resistance	$T_{vj} = T_{vj \max}$	r_{T}		1,75	$\text{m}\Omega$
Zündstrom gate trigger current	$T_{vj} = 25^{\circ}\text{C}, v_{\text{D}} = 6 \text{ V}$	i_{GT}	max.	150	mA
Zündspannung gate trigger voltage	$T_{vj} = 25^{\circ}\text{C}, v_{\text{D}} = 6 \text{ V}$	V_{GT}	max.	2	V
Nicht zündender Steuerstrom gate non-trigger current	$T_{vj} = T_{vj \max}, v_{\text{D}} = 6 \text{ V}$ $T_{vj} = T_{vj \max}, v_{\text{D}} = 0,5 V_{\text{DRM}}$	I_{GD}	max. max.	10 5	mA mA
Nicht zündende Steuerspannung gate non-trigger voltage	$T_{vj} = T_{vj \max}, v_{\text{D}} = 0,5 V_{\text{DRM}}$	V_{GD}	max.	0,25	V
Haltestrom holding current	$T_{vj} = 25^{\circ}\text{C}, v_{\text{D}} = 6 \text{ V}, R_{\text{A}} = 5 \Omega$	I_{H}	max.	200	mA
Einraststrom latching current	$T_{vj} = 25^{\circ}\text{C}, v_{\text{D}} = 6 \text{ V}, R_{\text{GK}} \geq 10 \Omega$ $i_{\text{GM}} = 0,6 \text{ A}, di_{\text{G}}/dt = 0,6 \text{ A}/\mu\text{s}$, $t_{\text{g}} = 20 \mu\text{s}$	I_{L}	max.	800	mA
Vorwärts- und Rückwärts-Sperrstrom forward off-state and reverse current	$T_{vj} = T_{vj \max}$ $v_{\text{D}} = V_{\text{DRM}}, v_{\text{R}} = V_{\text{RRM}}$	$i_{\text{D}}, i_{\text{R}}$	max.	30	mA
Zündverzögerung gate controlled delay time	DIN IEC 747-6 $T_{vj} = 25^{\circ}\text{C}$, $i_{\text{GM}} = 0,6 \text{ A}, di_{\text{G}}/dt = 0,6 \text{ A}/\mu\text{s}$	t_{gd}	max.	3	μs

prepared by:	AG	date of publication:	2021-05-21
approved by:	ML	revision:	3.4

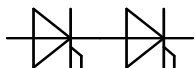

Datenblatt / Data sheet



Netz-Thyristor-Modul
Phase Control Thyristor Module

TT140N

Infineon Technologies Bipolar
GmbH & Co. KG

Elektrische Eigenschaften / Electrical properties

Charakteristische Werte / Characteristic values

Freiwerdezeit circuit commutated turn-off time	$T_{vj} = T_{vj\max}$, $i_{TM} = I_{TAVM}$ $V_{RM} = 100\text{ V}$, $V_{DM} = 0,67 V_{DRM}$ $dv_D/dt = 20\text{ V}/\mu\text{s}$, $-di_T/dt = 10\text{ A}/\mu\text{s}$ 5.Kennbuchstabe / 5 th letter O	t_q	typ.	300	μs
Isolations-Prüfspannung insulation test voltage	RMS, $f = 50\text{ Hz}$, $t = 1\text{ min}$ RMS, $f = 50\text{ Hz}$, $t = 1\text{ sec}$	V_{ISOL}		2,5 3,0	kV kV

Thermische Eigenschaften / Thermal properties

Innerer Wärmewiderstand thermal resistance, junction to case	pro Modul / per Module, $\Theta = 180^\circ\text{ sin}$ pro Zweig / per arm, $\Theta = 180^\circ\text{ sin}$ pro Modul / per Module, DC pro Zweig / per arm, DC	R_{thJC}	max.	0,095 0,190 0,092 0,183	$^\circ\text{C}/\text{W}$ $^\circ\text{C}/\text{W}$ $^\circ\text{C}/\text{W}$ $^\circ\text{C}/\text{W}$
Übergangs-Wärmewiderstand thermal resistance, case to heatsink	pro Modul / per Module pro Zweig / per arm	R_{thCH}	max.	0,03 0,06	$^\circ\text{C}/\text{W}$ $^\circ\text{C}/\text{W}$
Übergangs-Wärmewiderstand mit TIM thermal resistance, case to heatsink, with TIM	pro Modul / per Module pro Zweig / per arm	R_{thCH}	max.	0,03 0,06	$^\circ\text{C}/\text{W}$ $^\circ\text{C}/\text{W}$
Höchstzulässige Sperrschichttemperatur maximum junction temperature		$T_{vj\max}$		125	$^\circ\text{C}$
Betriebstemperatur operating temperature		$T_{c\text{ op}}$		-40...+125	$^\circ\text{C}$
Lagertemperatur storage temperature		T_{stg}		-40...+130	$^\circ\text{C}$
Lagertemperatur mit TIM storage temperature with TIM				+5...+40	$^\circ\text{C}$

Mechanische Eigenschaften / Mechanical properties

Gehäuse, siehe Anlage case, see annex				Seite 3 page 3	
Si-Element mit Druckkontakt Si-pellet with pressure contact					
Innere Isolation internal insulation				AIN	
Anzugsdrehmoment für mechanische Anschlüsse mounting torque	Toleranz / Tolerance $\pm 15\%$	M1		6	Nm
Anzugsdrehmoment für elektrische Anschlüsse terminal connection torque	Toleranz / Tolerance $\pm 10\%$	M2		6	Nm
Steueranschlüsse control terminals	DIN 46 244			A 2,8 x 0,8	
Gewicht weight		G	typ.	310	g
Kriechstrecke creepage distance				15	mm
Schwingfestigkeit vibration resistance	$f = 50\text{ Hz}$			50	m/s^2
	file-No.			E 83335	

Mit diesem Datenblatt werden Halbleiterbauelemente spezifiziert, jedoch keine Eigenschaften zugesichert. Es gilt in Verbindung mit den zugehörigen technischen Erläuterungen.

This data sheet specifies semiconductor devices, but promises no characteristics. It is valid in combination with the belonging technical notes.

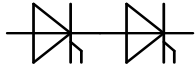

Datenblatt / Data sheet



Netz-Thyristor-Modul
Phase Control Thyristor Module

TT140N

Infineon Technologies Bipolar
GmbH & Co. KG

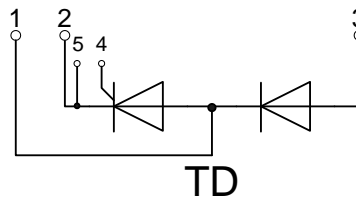
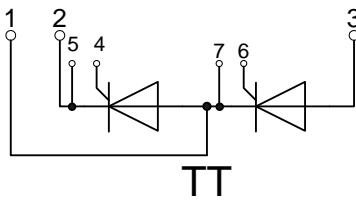
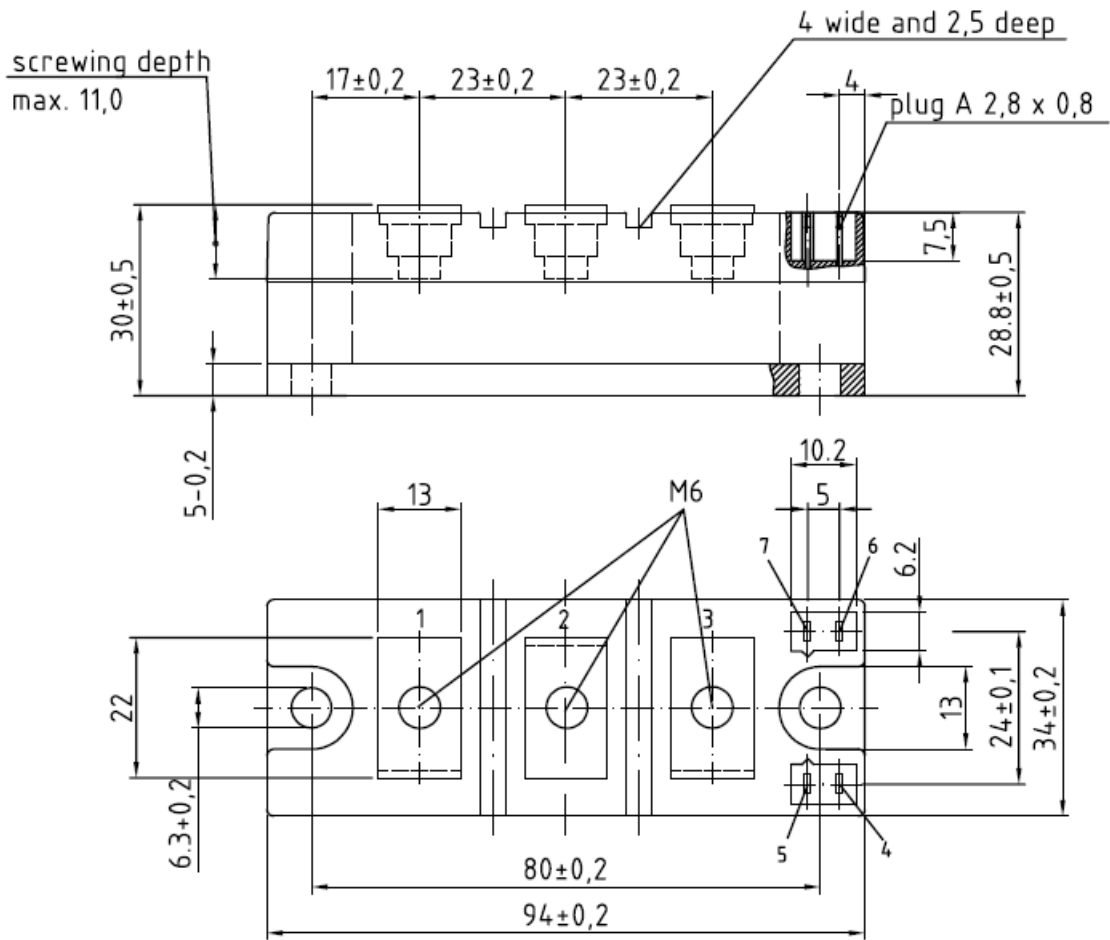

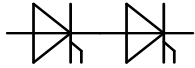
**Analytische Elemente des transienten Wärmewiderstandes Z_{thJC} für DC**
Analytical elements of transient thermal impedance Z_{thJC} for DC

Pos. n	1	2	3	4	5	6	7
R_{thn} [°C/W]	0,0094	0,0224	0,0586	0,0924			
τ_n [s]	0,0014	0,0253	0,267	1,68			

Analytische Funktion / Analytical function:
$$Z_{thJC} = \sum_{n=1}^{n_{max}} R_{thn} \left(1 - e^{-\frac{t}{\tau_n}} \right)$$

Luftselbstkühlung / Natural cooling
3 Module pro Kühlkörper / 3 modules per heatsink
Kühlkörper / Heatsink type: KM17 (45W)

Analytische Elemente des transienten Wärmewiderstandes Z_{thCA}
Analytical elements of transient thermal impedance Z_{thCA}

Pos. n	1	2	3	4	5	6	7
R_{thn} [°C/W]	1,71	0,135	0,013				
τ_n [s]	1200	14	4				

Verstärkte Kühlung / Forced cooling
3 Module pro Kühlkörper / 3 modules per heatsink
Kühlkörper / Heatsink type: KM17 (Papst 4650N)

Analytische Elemente des transienten Wärmewiderstandes Z_{thCA}
Analytical elements of transient thermal impedance Z_{thCA}

Pos. n	1	2	3	4	5	6	7
R_{thn} [°C/W]	0,515	0,119	0,026				
τ_n [s]	354	13,6	2,41				

Analytische Funktion / Analytical function:
$$Z_{thCA} = \sum_{n=1}^{n_{max}} R_{thn} \left(1 - e^{-\frac{t}{\tau_n}} \right)$$

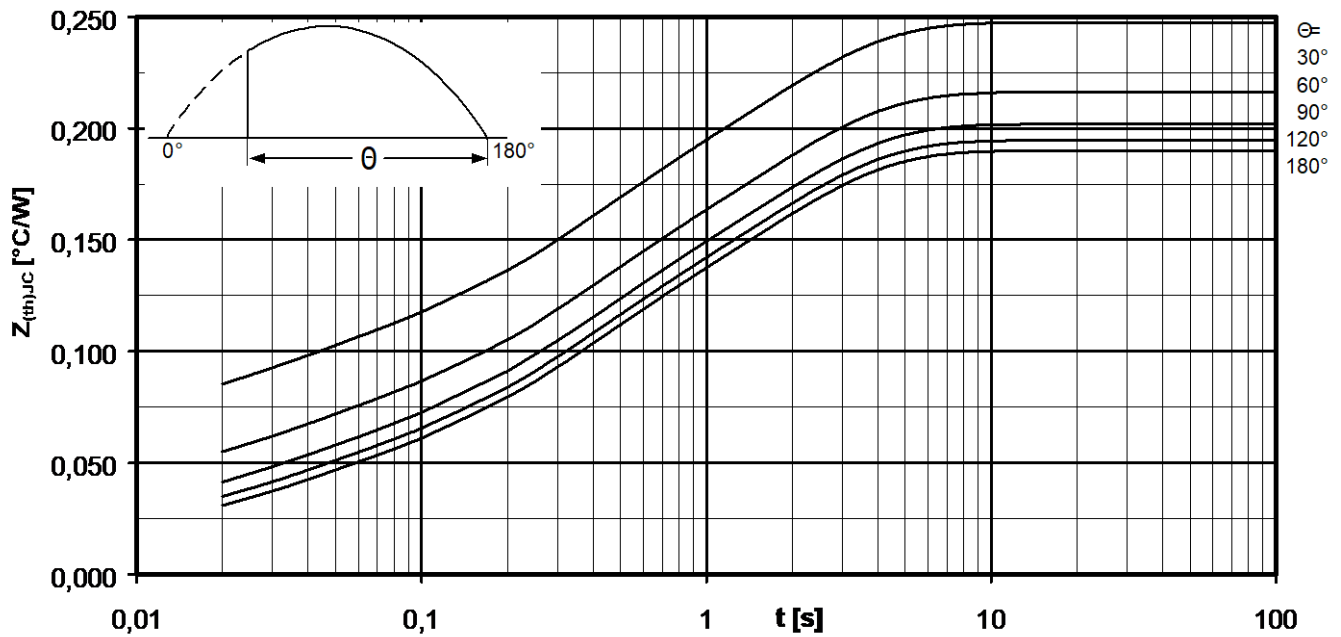
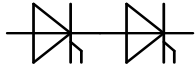

Transienter innerer Wärmewiderstand je Zweig / Transient thermal impedance per arm $Z_{thJC} = f(t)$

Sinusförmiger Strom / Sinusoidal current

Parameter: Stromflußwinkel Θ / Current conduction angle Θ

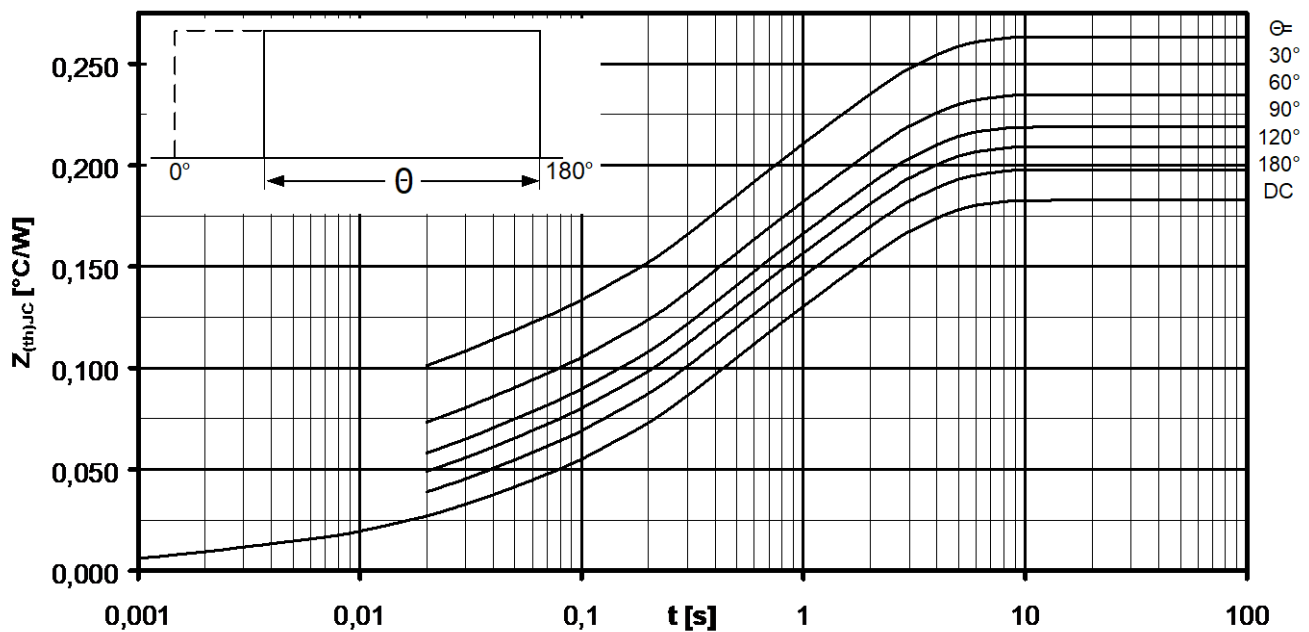

Transienter innerer Wärmewiderstand je Zweig / Transient thermal impedance per arm $Z_{thJC} = f(t)$

Rechteckförmiger Strom / Rectangular current

Parameter: Stromflußwinkel Θ / Current conduction angle Θ

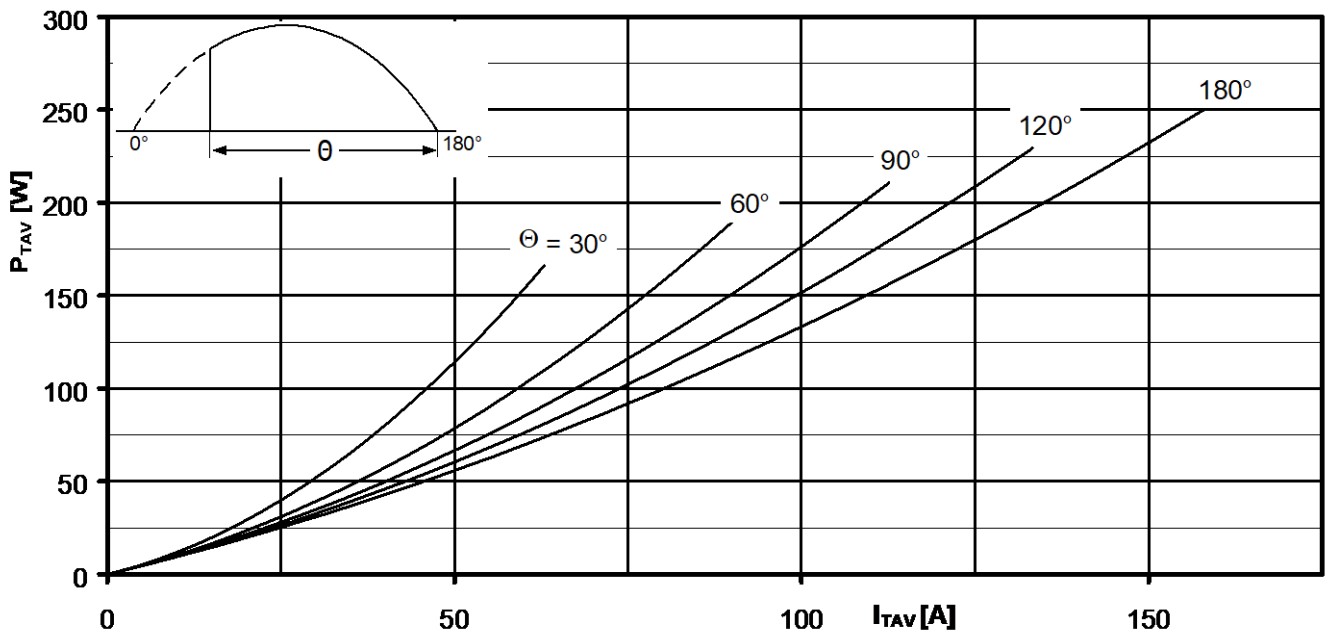
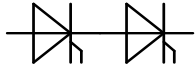

Durchlassverlustleistung je Zweig / On-state power loss per arm $P_{TAV} = f(I_{TAV})$

Sinusförmiger Strom / Sinusoidal current Strombelastung je Zweig / Current load per arm

Berechnungsgrundlage P_{TAV} (Schaltverluste gesondert berücksichtigen)
Calculation base P_{TAV} (switching losses should be considered separately)

Parameter: Stromflußwinkel / Current conduction angle Θ

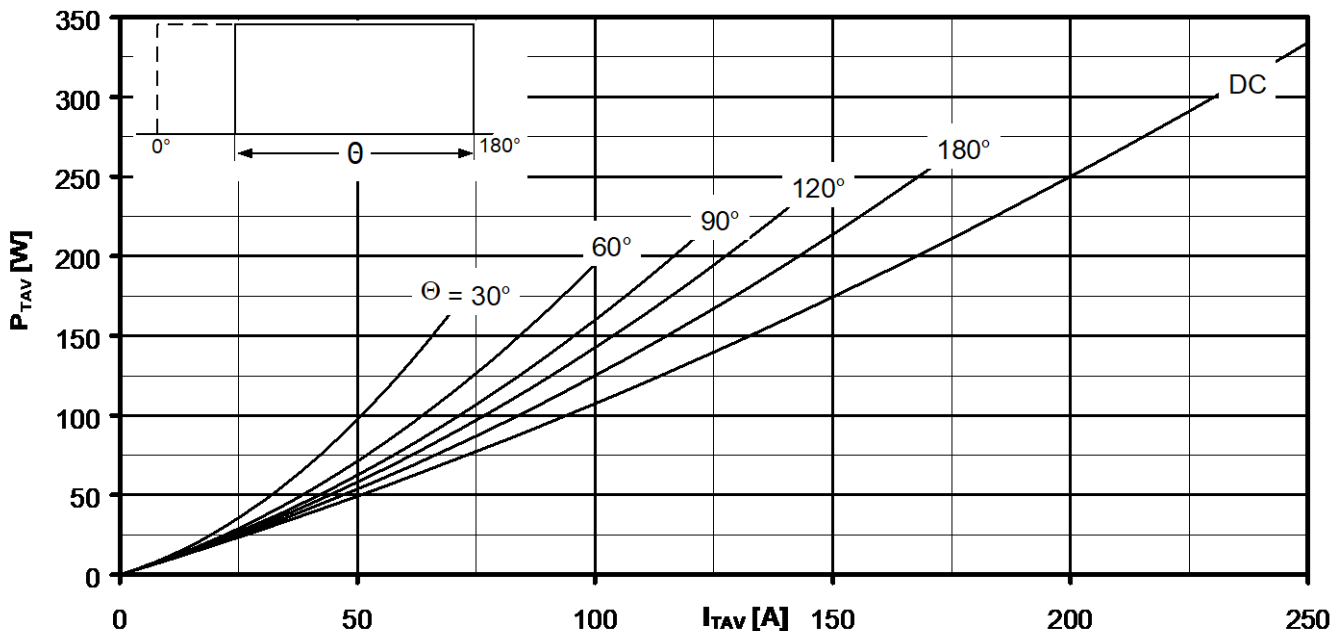

Durchlassverlustleistung je Zweig / On-state power loss per arm $P_{TAV} = f(I_{TAV})$

Rechteckförmiger Strom / Rectangular current Strombelastung je Zweig / Current load per arm

Berechnungsgrundlage P_{TAV} (Schaltverluste gesondert berücksichtigen)
Calculation base P_{TAV} (switching losses should be considered separately)

Parameter: Stromflußwinkel / Current conduction angle Θ

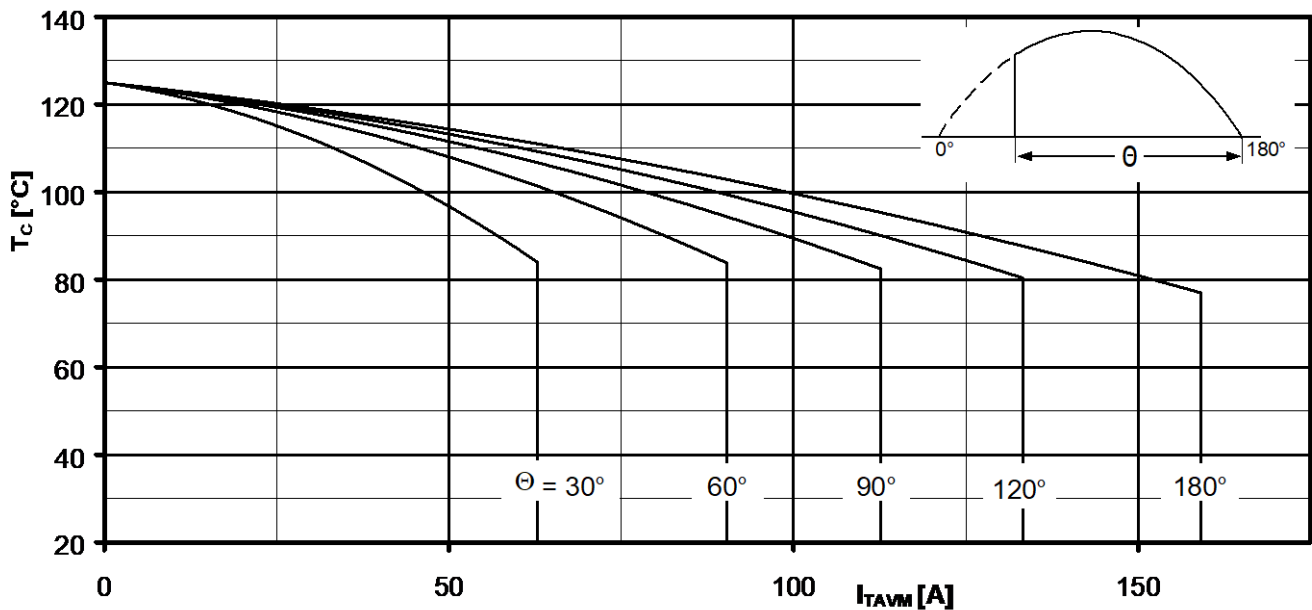
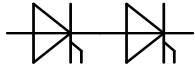

Höchstzulässige Gehäusetemperatur / Maximum allowable case temperature $T_c = f(I_{TAVM})$

Sinusförmiger Strom / Sinusoidal current Strombelastung je Zweig / Current load per arm

Berechnungsgrundlage P_{TAV} (Schaltverluste gesondert berücksichtigen)
Calculation base P_{TAV} (switching losses should be considered separately)

Parameter: Stromflußwinkel Θ / Current conduction angle Θ

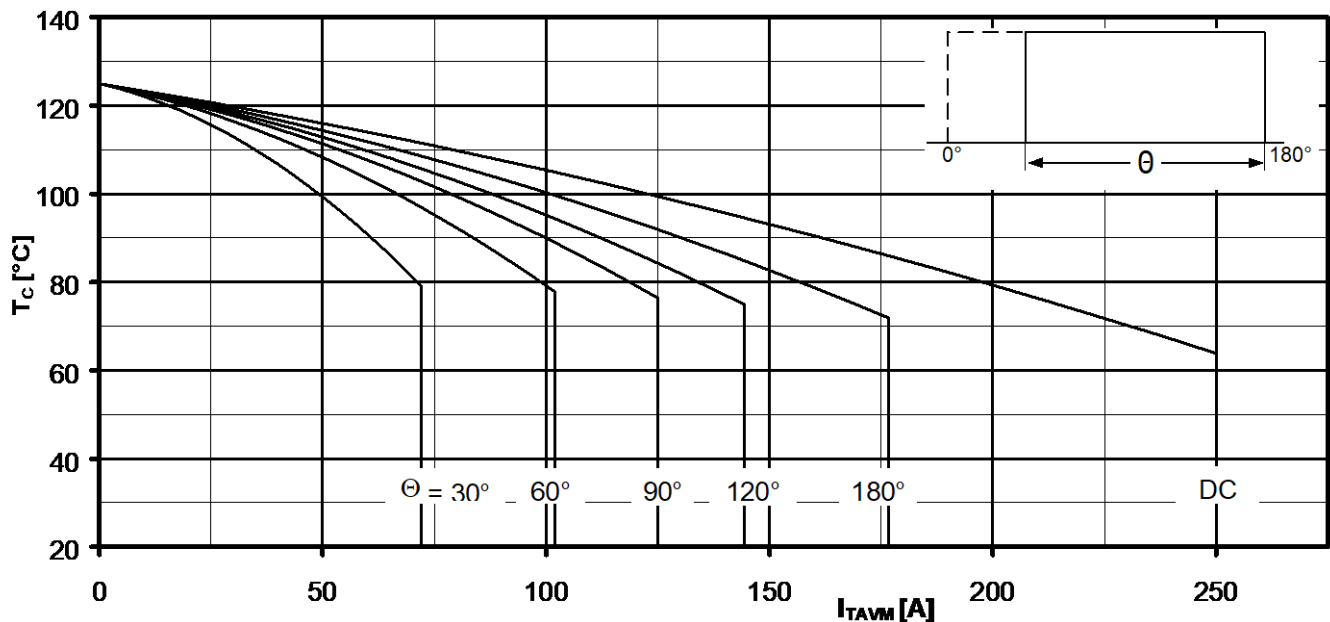

Höchstzulässige Gehäusetemperatur / Maximum allowable case temperature $T_c = f(I_{TAVM})$

Rechteckförmiger Strom / Rectangular current Strombelastung je Zweig / Current load per arm

Berechnungsgrundlage P_{TAV} (Schaltverluste gesondert berücksichtigen)
Calculation base P_{TAV} (switching losses should be considered separately)

Parameter: Stromflußwinkel Θ / Current conduction angle Θ

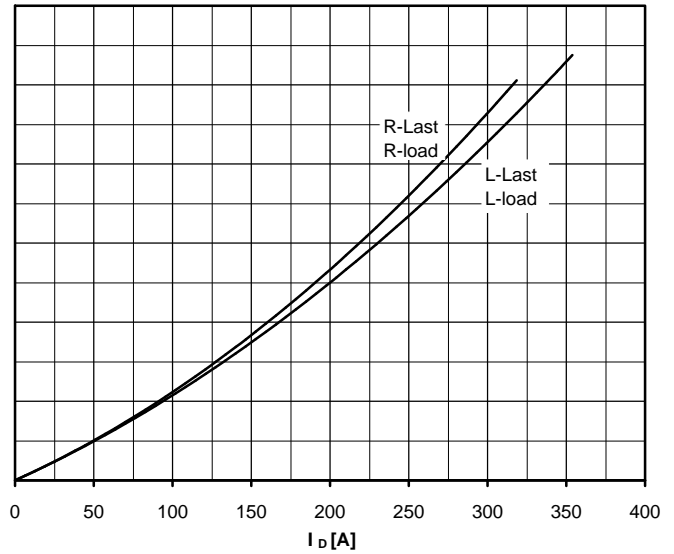
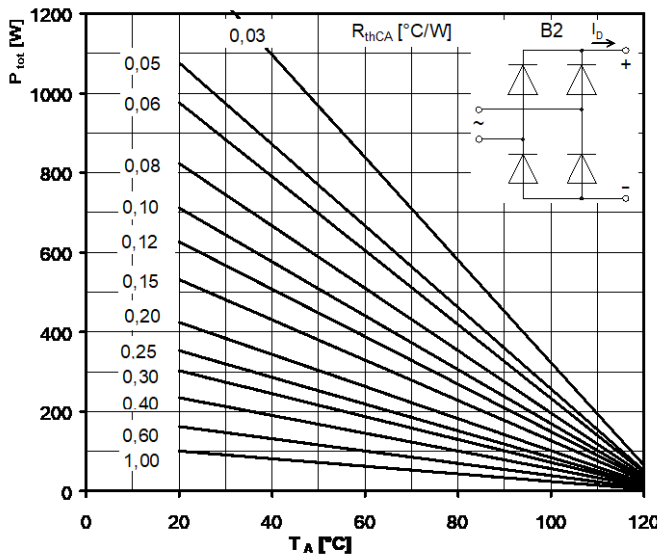
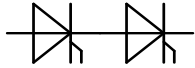

Höchstzulässiger Ausgangsstrom / Maximum rated output current I_D

B2- Zweipuls-Brückenschaltung / Two-pulse bridge circuit

Gesamtverlustleistung der Schaltung / Total power dissipation at circuit P_{tot}

Parameter:

Wärmewiderstand zwischen den Gehäusen und Umgebung / Thermal resistance cases to ambient R_{thCA}

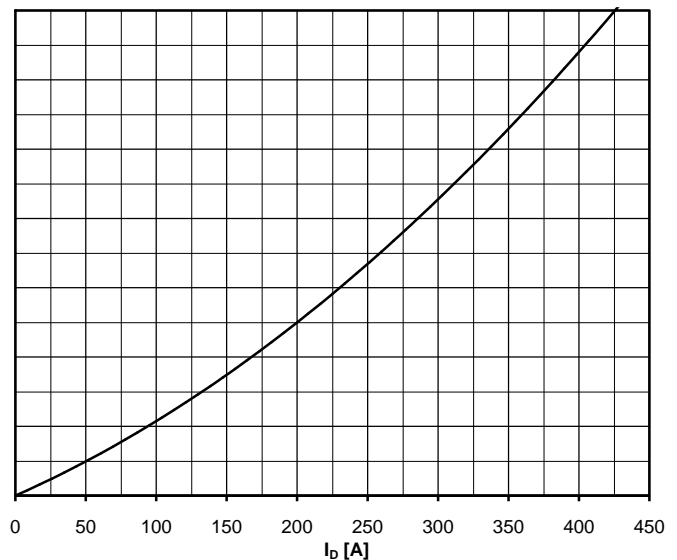
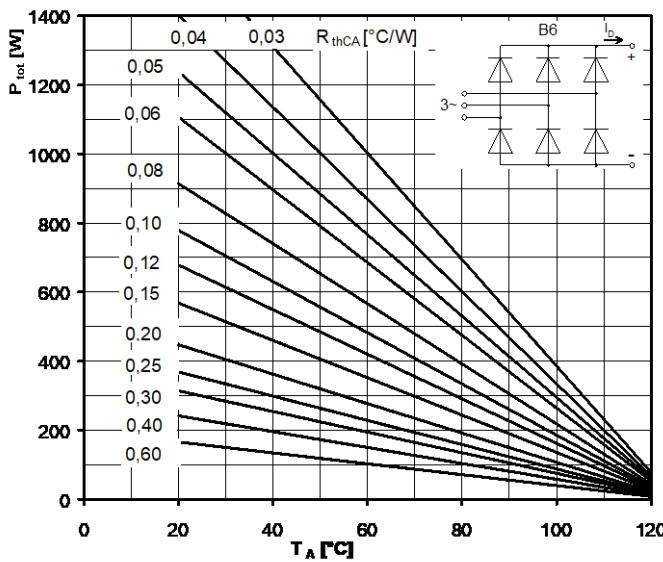

Höchstzulässiger Ausgangsstrom / Maximum rated output current I_D

B6- Sechspuls-Brückenschaltung / Six-pulse bridge circuit

Gesamtverlustleistung der Schaltung / Total power dissipation at circuit P_{tot}

Parameter:

Wärmewiderstand zwischen den Gehäusen und Umgebung / Thermal resistance cases to ambient R_{thCA}

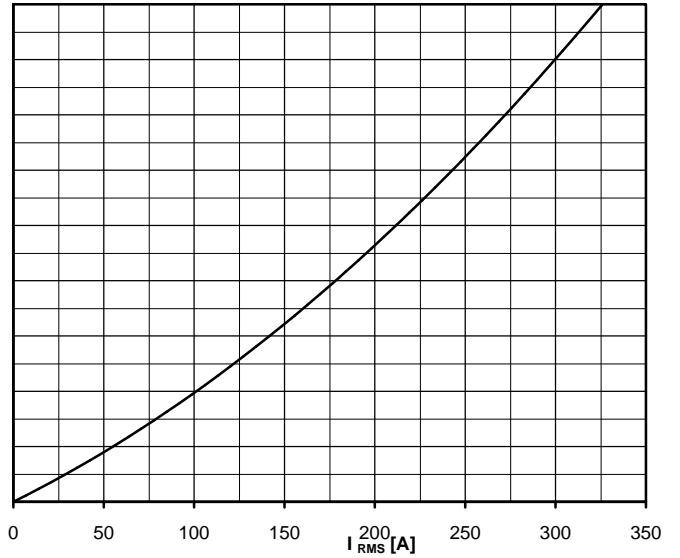
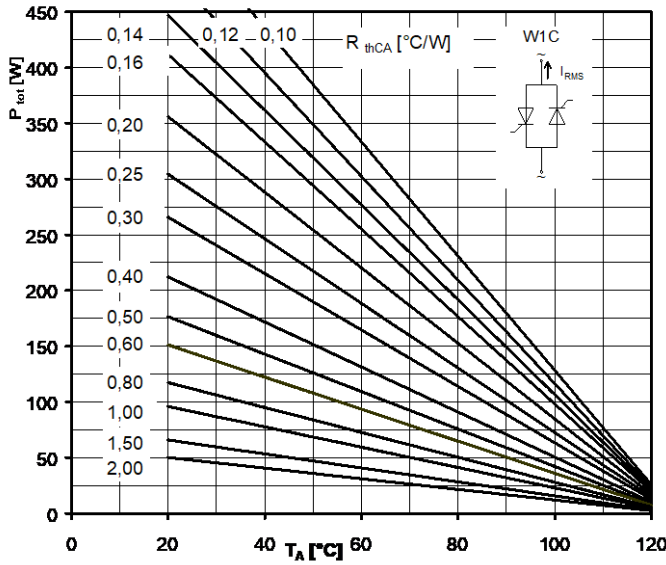
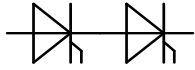

Höchstzulässiger Effektivstrom / Maximum rated RMS current I_{RMS}

W1C - Einphasen-Wechselwegschaltung / Single-phase inverse parallel circuit

Gesamtverlustleistung der Schaltung / Total power dissipation at circuit P_{tot}

Parameter:

Wärmewiderstand zwischen den Gehäusen und Umgebung / Thermal resistance case to ambient R_{thCA}

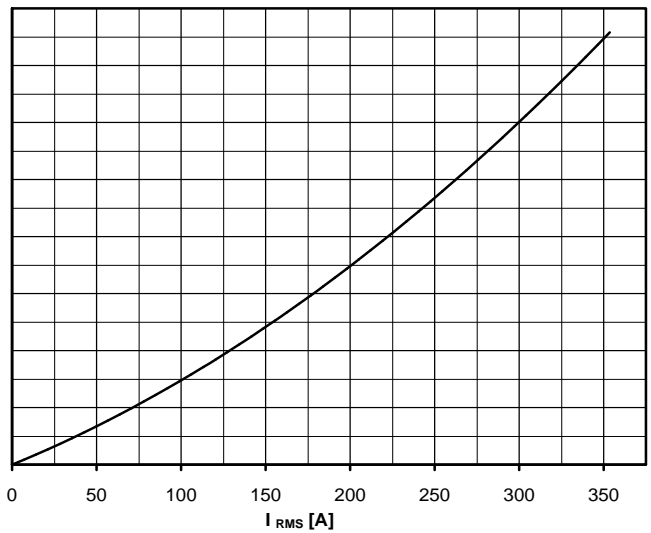
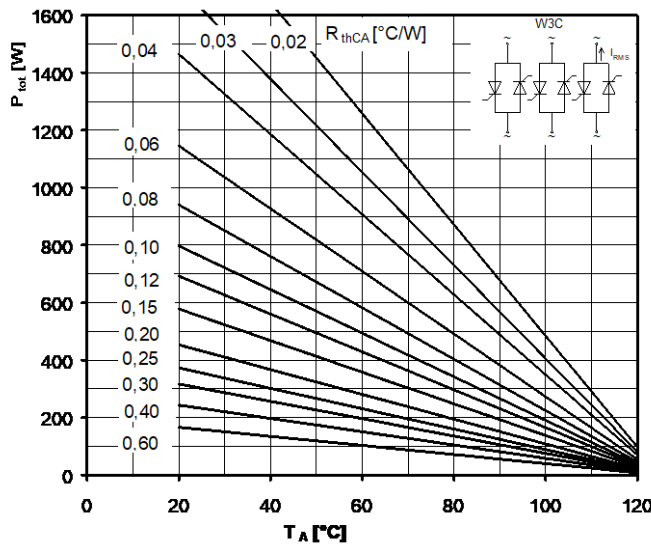

Höchstzulässiger Effektivstrom / Maximum rated RMS current I_{RMS}

W3C - Dreiphasen-Wechselwegschaltung / Three-phase inverse parallel circuit

Gesamtverlustleistung der Schaltung / Total power dissipation at circuit P_{tot}

Parameter:

Wärmewiderstand zwischen den Gehäusen und Umgebung / Thermal resistance cases to ambient R_{thCA}

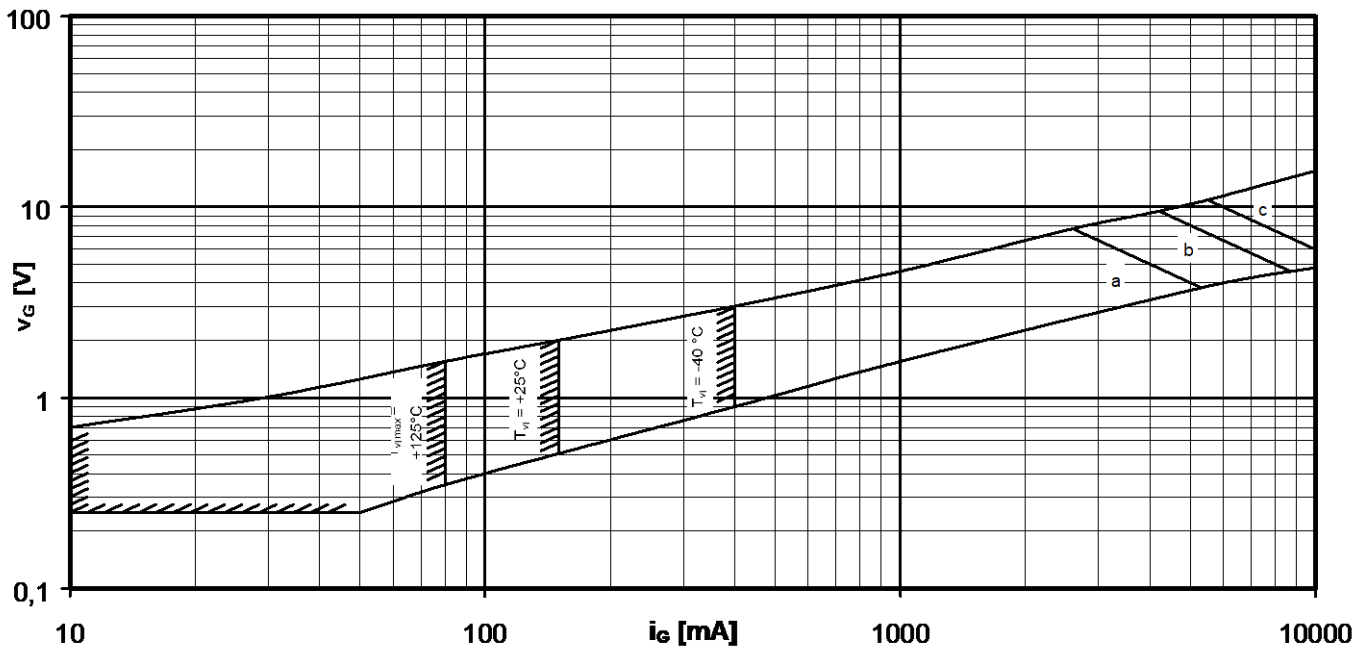
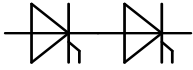

Steuercharakteristik $v_G = f(i_G)$ mit Zündbereichen für $V_D = 6\text{ V}$
Gate characteristic $v_G = f(i_G)$ with triggering area for $V_D = 6\text{ V}$

Höchstzulässige Spitzensteuerverlustleistung / Maximum rated peak gate power dissipation $P_{GM} = f(t_g)$:

a - 20 W/10ms b - 40 W/1ms c - 60 W/0,5ms

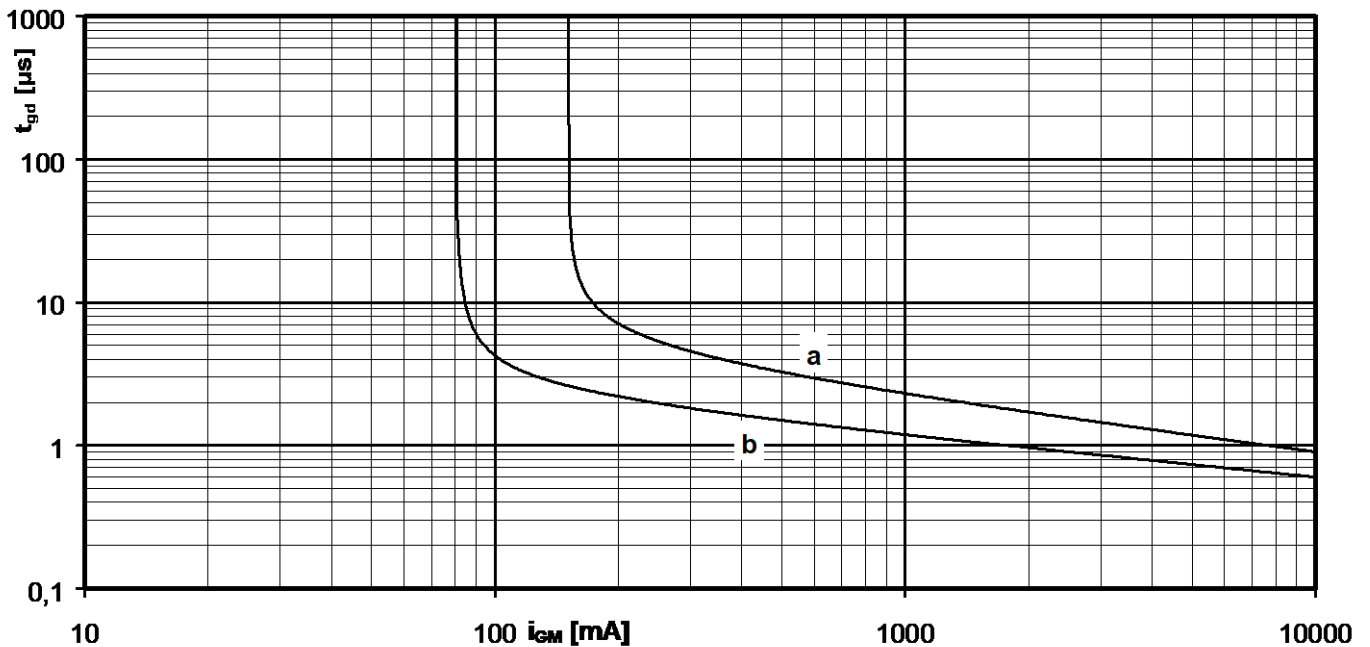

Zündverzögerung / Gate controlled delay time $t_{gd} = f(i_G)$

$T_{vj} = 25^\circ\text{C}$, $di_G/dt = i_{GM}/1\mu\text{s}$

a - maximaler Verlauf / Limiting characteristic

b - typischer Verlauf / Typical characteristic

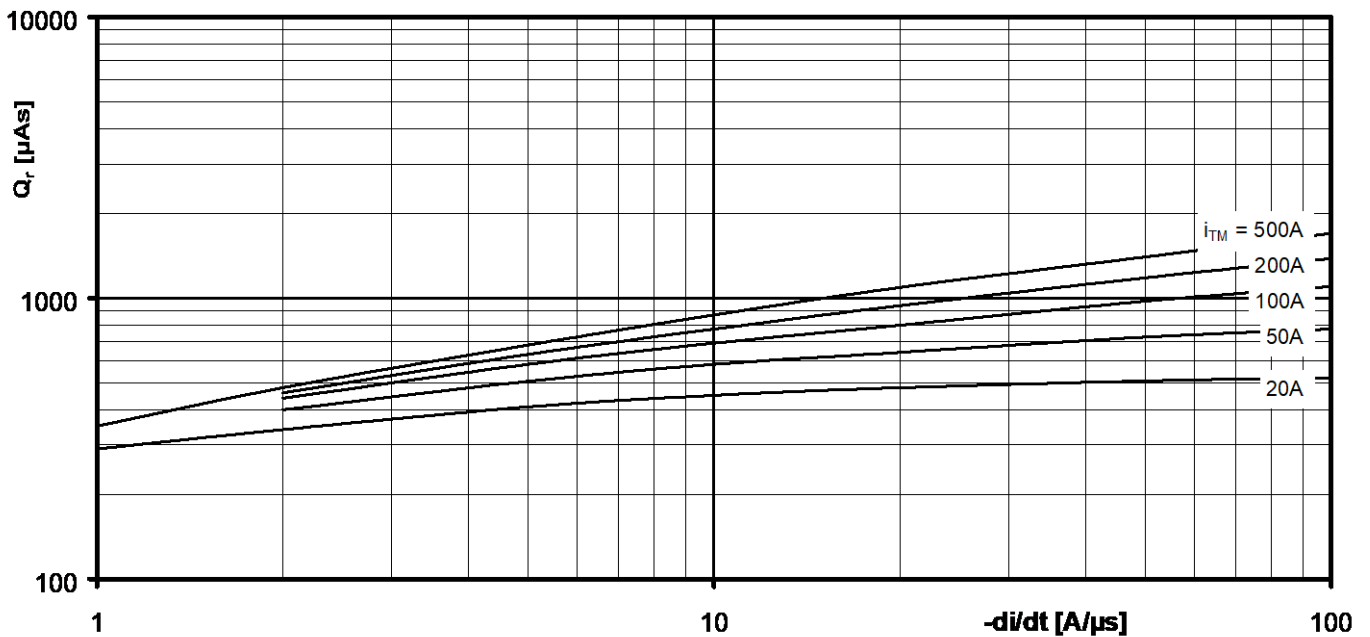
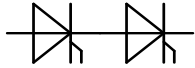

Sperrverzögerungsladung / Recovered charge $Q_r = f(-di/dt)$

$$T_{vj} = T_{vjmax}, V_R \leq 0,5 V_{RRM}, V_{RM} = 0,8 V_{RRM}$$

Parameter: Durchlaßstrom / On-state current i_{TM}

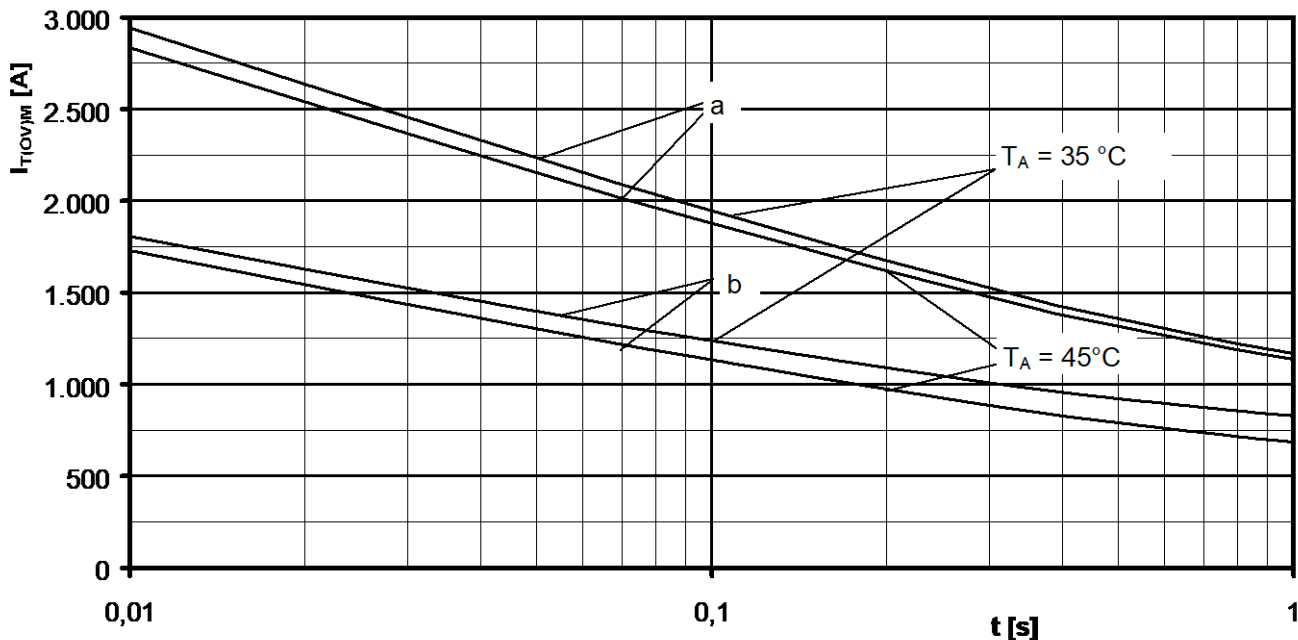

Grenzstrom / Maximum overload on-state current $I_{T(OV)M} = f(t), V_{RM} = 0,8 V_{RRM}$

a: Leerlauf / No-load conditions

b: nach Belastung mit I_{TAVM} / after load with I_{TAVM}

$T_A = 35^\circ\text{C}$, verstärkte Luftkühlung / Forced air cooling

$T_A = 45^\circ\text{C}$, Luftselbstkühlung / Natural air cooling

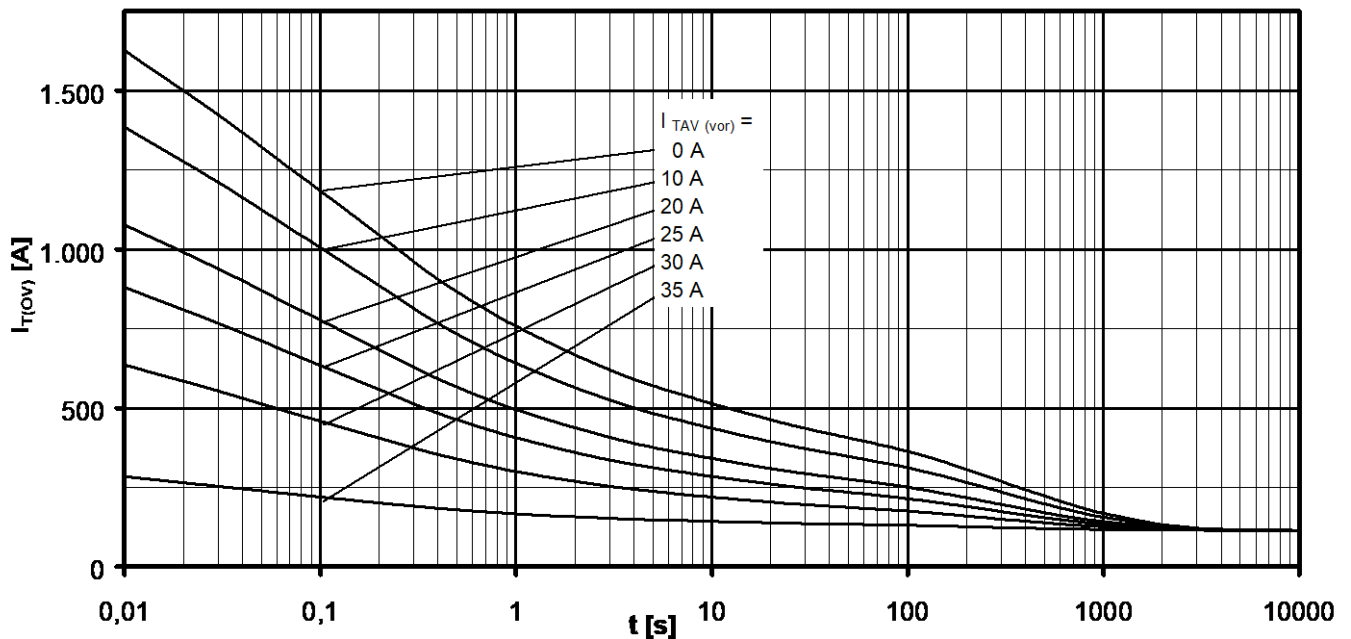
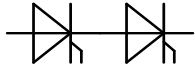

Überstrom je Zweig / Overload on-state current $I_{T(ov)}$

B6- Sechspuls-Brückenschaltung, 120° Rechteck / Six-pulse bridge circuit, 120° rectangular

Kühlkörper / Heatsink type KM17 (45W) Luftselbstkühlung bei / Natural cooling at $T_A = 45^\circ\text{C}$

Parameter: Vorlaststrom je Zweig / Pre-load current per arm $I_{TAV(vor)}$

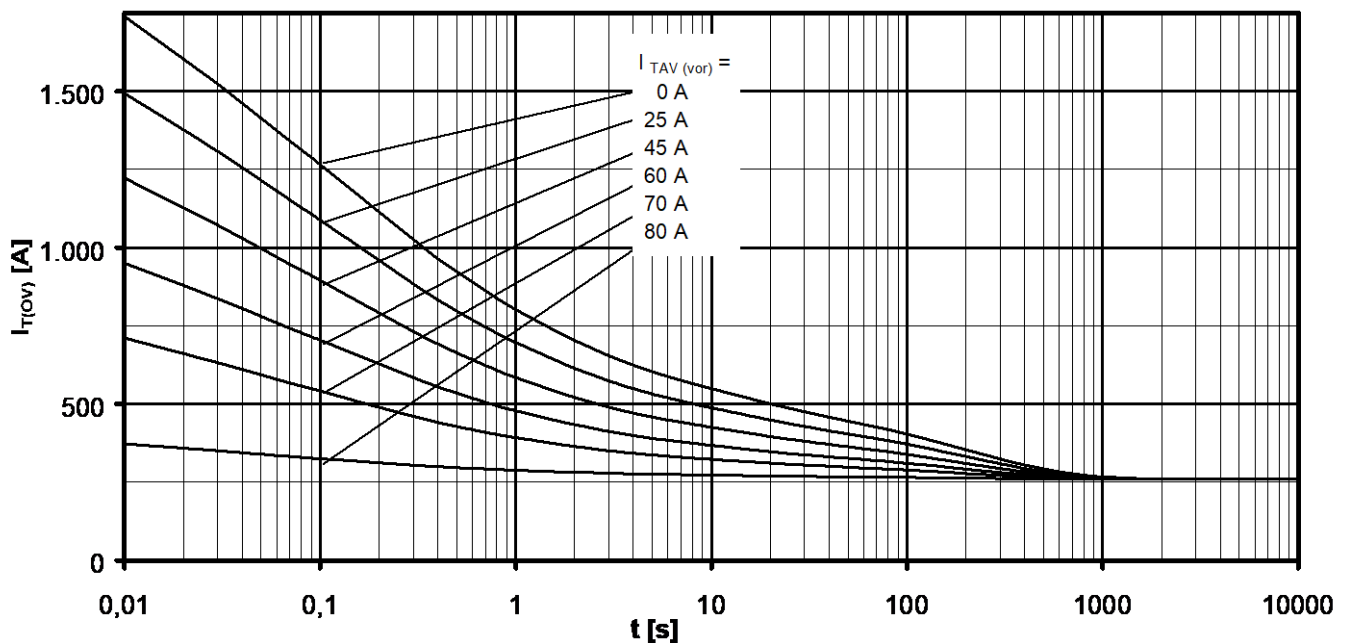

Überstrom je Zweig / Overload on-state current $I_{T(ov)}$

B6- Sechspuls-Brückenschaltung, 120° Rechteck / Six-pulse bridge circuit, 120° rectangular

Kühlkörper / Heatsink type KM17 (Papst 4650N) Verstärkte Kühlung bei / Forced cooling at $T_A = 35^\circ\text{C}$

Parameter: Vorlaststrom je Zweig / Pre-load current per arm $I_{TAV(vor)}$