

# Through the Roller Sensor Family



## Datasheet



- Reliable leading edge detection of letters, thin packages, poly bags, totes, boxes or other product on roller conveyors
- Mounts between conveyor roller gap to standard hex or round side rail holes with no extra hardware required or on the T-Slot with customer supplied bracket and hardware
- Spring loaded end caps reduce installation and alignment time for reduced labor costs
- Built to order with specified length and beam spacing: 200 mm to up to 1500 mm (8 in to up to 59 in) depending on mounting configuration, with 2 to 10 sensors for maximum flexibility
- Robust aluminum housing, ambient light and ESD resistance for enhanced durability



### WARNING:

- **Do not use this device for personnel protection**
- Using this device for personnel protection could result in serious injury or death.
- This device does not include the self-checking redundant circuitry necessary to allow its use in personnel safety applications. A device failure or malfunction can cause either an energized (on) or de-energized (off) output condition.

## Models

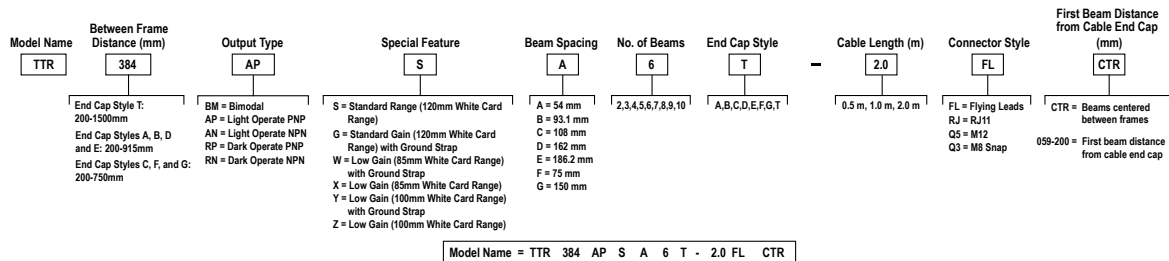

**Note:** For definition of the End Cap Styles, see [Table 1](#) on page 2.



**Note:** Sensors with more than 7 beams have higher minimum supply voltage requirements, see [Specifications](#) on page 5.

## Configurations

Figure 1. Spring End Cap Configuration

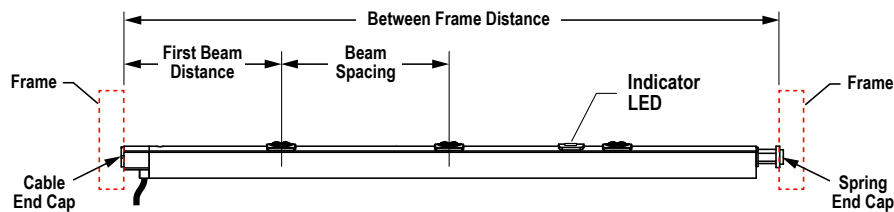

Figure 2. T-Slot Configuration

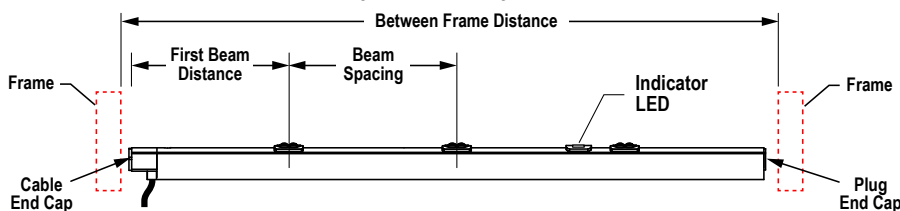

Figure 3. Adhesive End Cap Configuration

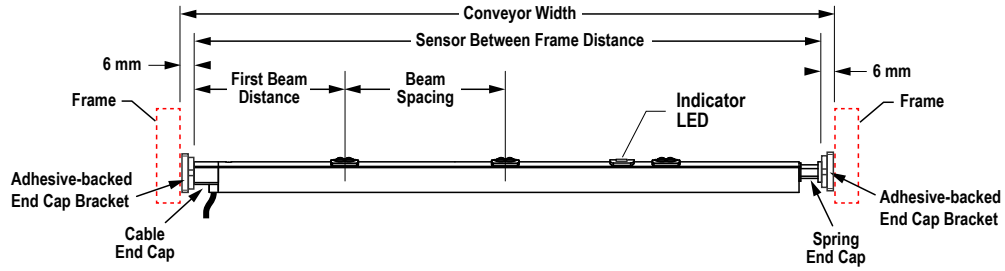

Table 1: End Cap Styles

End Cap Style		End 1		End 2
A	11 mm Hex, flat side up		Spring 11 mm hex / 8 mm round	
B	11 mm Hex, point up		Spring 11 mm hex / 8 mm round	
C	Adjustable 11 mm Hex, can be positioned in 10 degree increments		Spring 11 mm hex / 8 mm round	
D	11 mm Hex, flat side up		Spring 8 mm round	
E	11 mm Hex, point up		Spring 8 mm round	
F	Adjustable 11 mm Hex, can be positioned in 10 degree increments		Spring 8 mm round	
G	Adjustable 11 mm Hex, can be positioned in 10 degree increments / adhesive backed bracket		Spring 11 mm hex / 8 mm round / adhesive backed bracket	
T	11 mm Hex, flat side up		Plug	



**Note:** T-Slot mounted sensors with the T End Cap Style are 6 mm shorter than the specified Between Frame Distance.

## Wiring

### Bimodal Output Wiring Diagrams

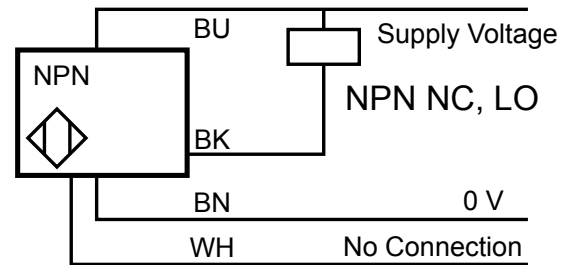
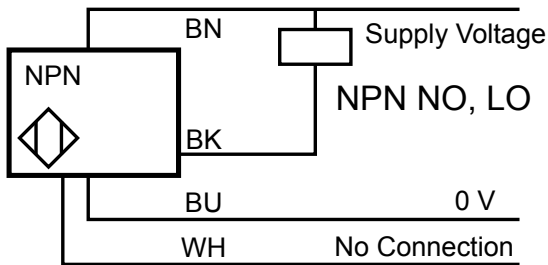
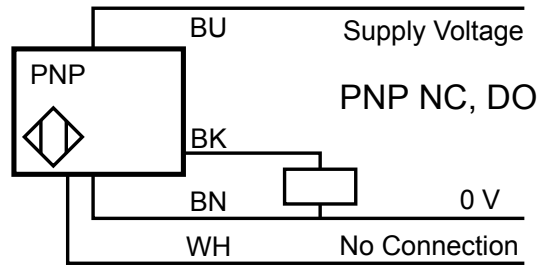
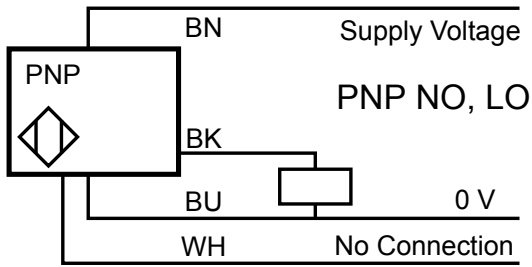

### Fixed NPN and PNP Output Wiring Diagrams: Light and Dark Operate by Model Number

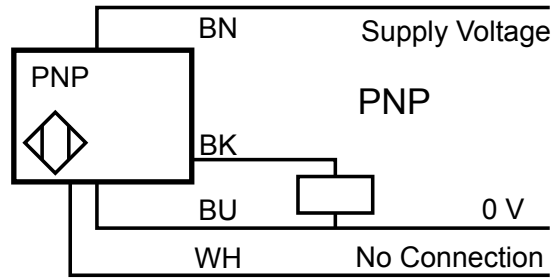
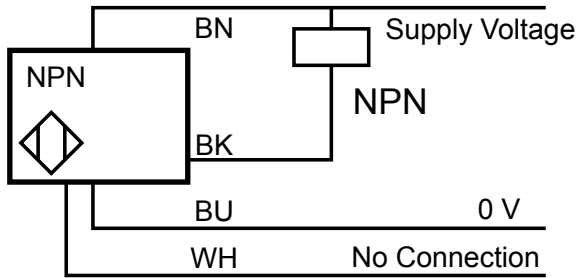

### RJ-11 Pinout

### RJ-11 Key

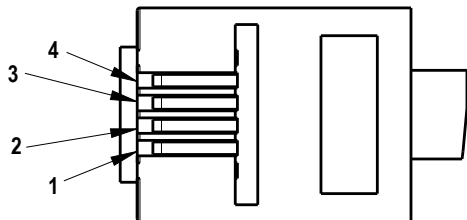

1. Brown
2. Black
3. White
4. Blue

### M12 Pinout

### M12 Key

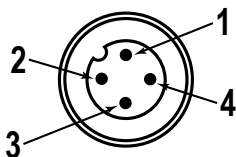

1. Brown
2. White
3. Blue
4. Black

M8 Snap Connector Pinout

M8 Key

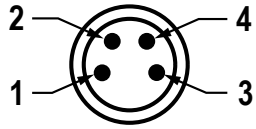

- 1. Brown
- 2. White
- 3. Blue
- 4. Black

Installation

Mounting Considerations

Conveyor Side View

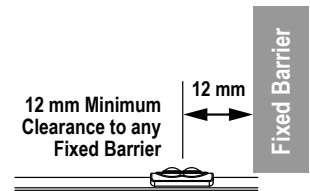
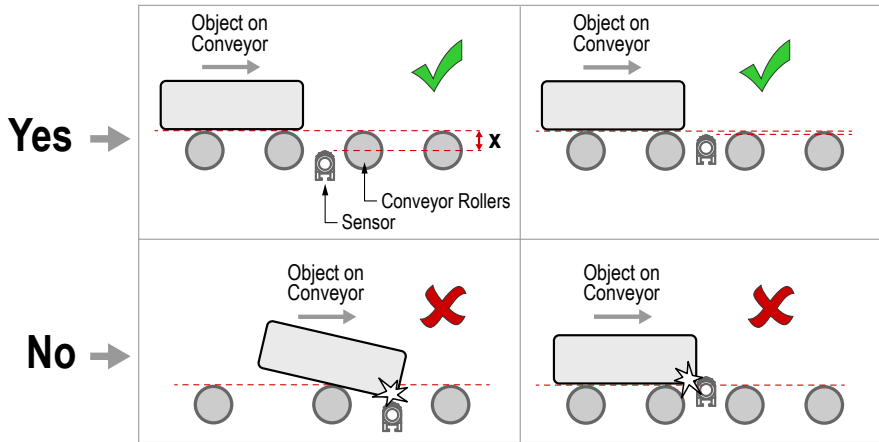

T-Slot Installation

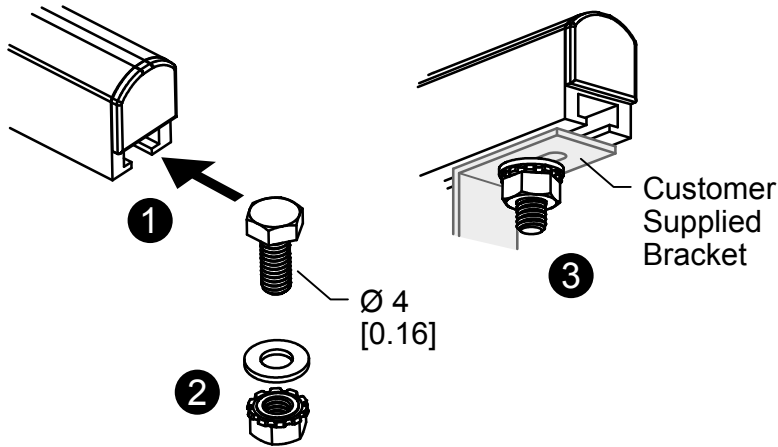

## Specifications

### Supply Voltage

Number of Sensing Beams	Supply Voltage with 10% Maximum Ripple
2, 3, 4, 5, 6, 7	18 V DC to 30 V DC
8	22 V DC to 30 V DC
9	24 V DC to 30 V DC
10	26 V DC to 30 V DC

Use only with a suitable Class 2 power supply (UL) or SELV power supply (CE)

### Supply Current

45 mA

### Supply Protection Circuitry

Protected against reverse polarity and transient voltages

### Wavelength

Infrared LED, 940 nm

### Output Response

1 ms on/off

### Output Configuration

Rating: 100 mA max output at 25 °C  
 Output Voltage High: Greater than Vsupply – 2.5 V  
 Output Voltage Low: Less than 2.5 V  
 For loads less than 1 Meg Ohm  
 Protected against false pulse on power-up and continuous overload or short-circuit of output

### Indicators

Amber on: Light sensed

### Sensing Mode

Diffuse, Infrared, 940 nm

### Range

Special Feature Type	Range		
	90% White Card	18% Gray Card	6% Black Card
S and G	0 to ≥ 120 mm	0 to ≥ 50 mm	≤ 3 to ≥ 30 mm
Y and Z	0 to ≥ 100 mm	0 to ≥ 40 mm	≤ 4 to ≥ 25 mm
W and X	0 to ≥ 85 mm	0 to ≥ 35 mm	≤ 6 to ≥ 20 mm

### Operating Conditions

-10 °C to +55 °C (+14 °F to +131 °F)

### Environmental Rating

IP50

### Vibration and Mechanical Shock

All models meet IEC 60068-2-6, IEC 60947-5-2, UL491 Section 40, MIL-STD-202F, Method 201A (Vibration: 10 Hz to 60 Hz, 0.5 mm peak-to-peak)  
 Shock: 30G 11 ms duration, half sine wave per IEC 60068-2-27

### Cable

Minimum static bend radius: 20 mm  
 Flex life > 10,000 cycles at flexing bend radius > 40 mm

### Certifications



**Banner Engineering Europe** Park Lane,  
 Culliganlaan 2F bus 3, 1831 Diegem,  
 BELGIUM



**Turck Banner LTD** Blenheim House,  
 Blenheim Court, Wickford, Essex SS11  
 8YT, Great Britain



IND. CONT. EQ.  
 E224071

## Performance Curves



**Note:** The Beam Pattern and Excess Gain performance curve diagrams represent the Standard Gain (Special Feature S and G) models.

