

Through the Roller Sensor Family



Datasheet



- Reliable leading edge detection of letters, thin packages, poly bags, totes, boxes or other product on roller conveyors
- Mounts between conveyor roller gap to standard hex or round side rail holes with no extra hardware required or on the T-Slot with customer supplied bracket and hardware
- Spring loaded end caps reduce installation and alignment time for reduced labor costs
- Built to order with specified length and beam spacing: 200 mm to up to 1500 mm (8 in to up to 59 in) depending on mounting configuration, with 2 to 10 sensors for maximum flexibility
- Robust aluminum housing, ambient light and ESD resistance for enhanced durability



WARNING:

- **Do not use this device for personnel protection**
- Using this device for personnel protection could result in serious injury or death.
- This device does not include the self-checking redundant circuitry necessary to allow its use in personnel safety applications. A device failure or malfunction can cause either an energized (on) or de-energized (off) output condition.

Models

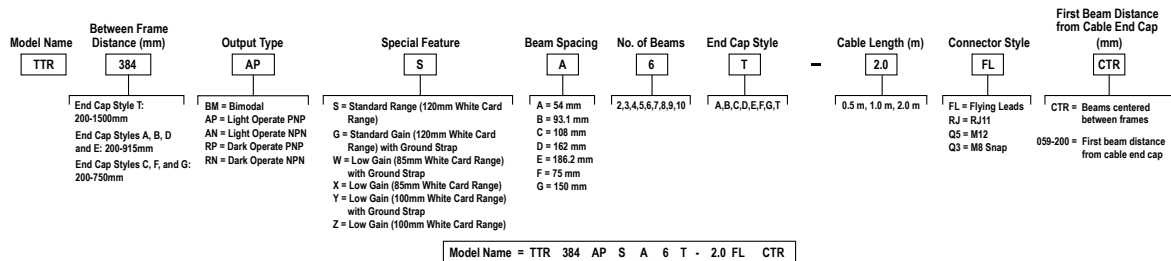

Note: For definition of the End Cap Styles, see [Table 1](#) on page 2.



Note: Sensors with more than 7 beams have higher minimum supply voltage requirements, see [Specifications](#) on page 5.

Configurations

Figure 1. Spring End Cap Configuration

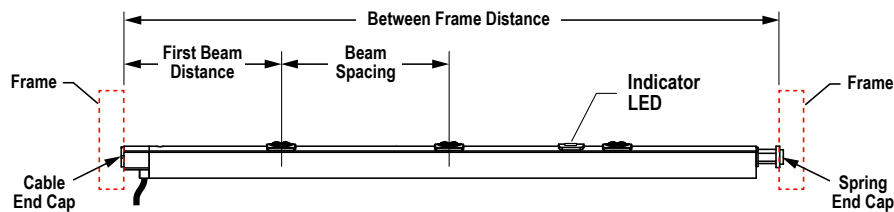
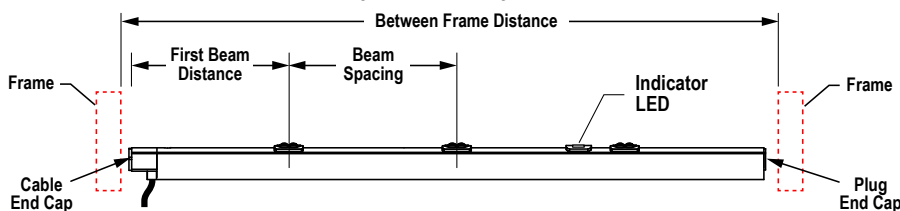

Figure 2. T-Slot Configuration



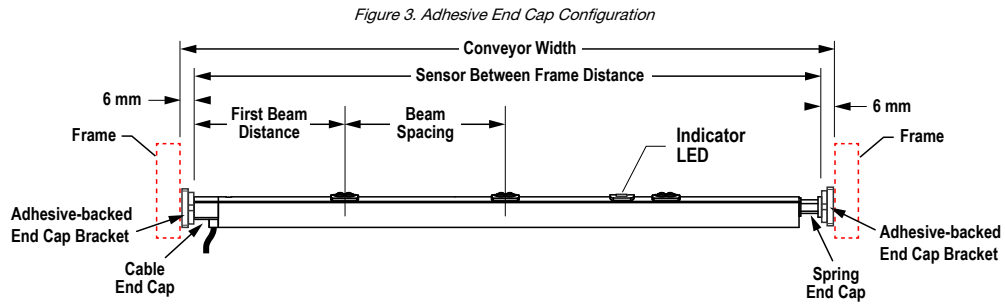

Table 1: End Cap Styles

End Cap Style		End 1		End 2
A	11 mm Hex, flat side up		Spring 11 mm hex / 8 mm round	
B	11 mm Hex, point up		Spring 11 mm hex / 8 mm round	
C	Adjustable 11 mm Hex, can be positioned in 10 degree increments		Spring 11 mm hex / 8 mm round	
D	11 mm Hex, flat side up		Spring 8 mm round	
E	11 mm Hex, point up		Spring 8 mm round	
F	Adjustable 11 mm Hex, can be positioned in 10 degree increments		Spring 8 mm round	
G	Adjustable 11 mm Hex, can be positioned in 10 degree increments / adhesive backed bracket		Spring 11 mm hex / 8 mm round / adhesive backed bracket	
T	11 mm Hex, flat side up		Plug	



Note: T-Slot mounted sensors with the T End Cap Style are 6 mm shorter than the specified Between Frame Distance.

Wiring

Bimodal Output Wiring Diagrams

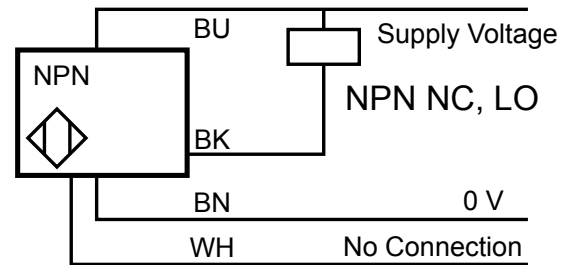
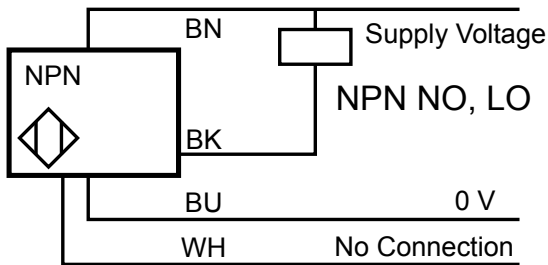
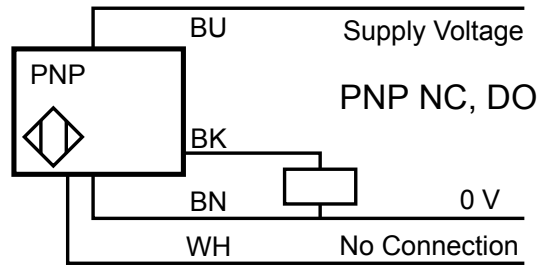
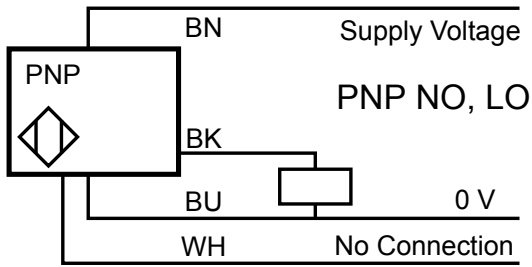

Fixed NPN and PNP Output Wiring Diagrams: Light and Dark Operate by Model Number

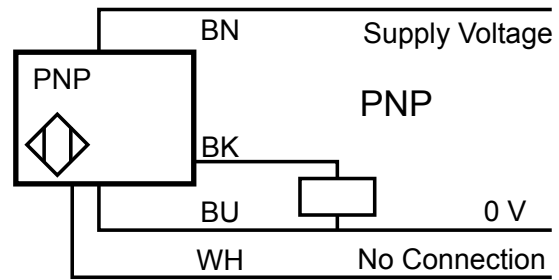
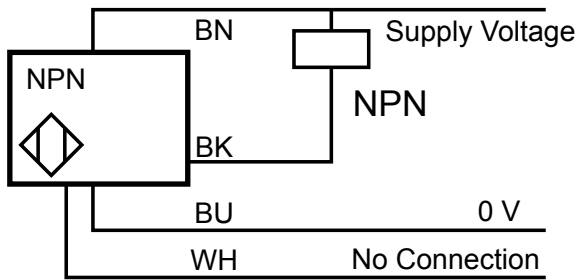

RJ-11 Pinout

RJ-11 Key

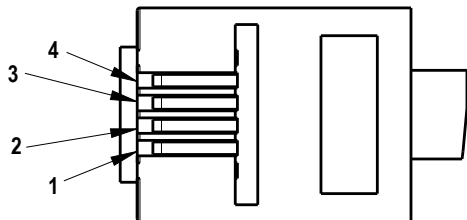

1. Brown
2. Black
3. White
4. Blue

M12 Pinout

M12 Key

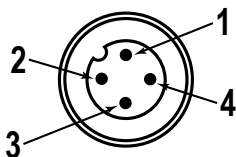

1. Brown
2. White
3. Blue
4. Black

M8 Snap Connector Pinout

M8 Key



- 1. Brown
- 2. White
- 3. Blue
- 4. Black

Installation

Mounting Considerations

Conveyor Side View

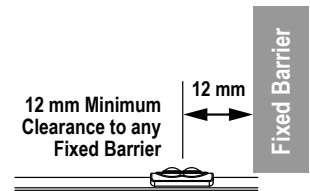
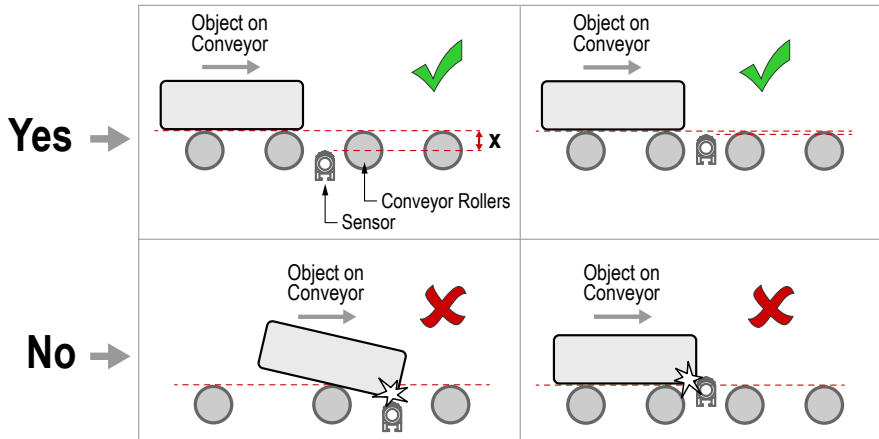

T-Slot Installation

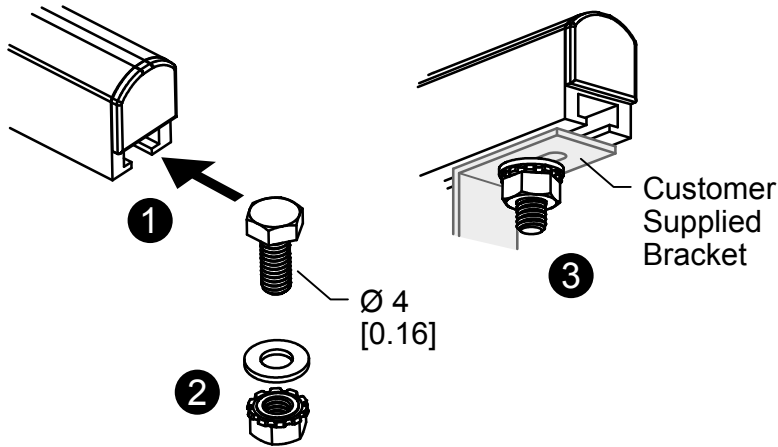

Specifications

Supply Voltage

Number of Sensing Beams	Supply Voltage with 10% Maximum Ripple
2, 3, 4, 5, 6, 7	18 V DC to 30 V DC
8	22 V DC to 30 V DC
9	24 V DC to 30 V DC
10	26 V DC to 30 V DC

Use only with a suitable Class 2 power supply (UL) or SELV power supply (CE)

Supply Current

45 mA

Supply Protection Circuitry

Protected against reverse polarity and transient voltages

Wavelength

Infrared LED, 940 nm

Output Response

1 ms on/off

Output Configuration

Rating: 100 mA max output at 25 °C
 Output Voltage High: Greater than Vsupply - 2.5 V
 Output Voltage Low: Less than 2.5 V
 For loads less than 1 Meg Ohm
 Protected against false pulse on power-up and continuous overload or short-circuit of output

Indicators

Amber on: Light sensed

Sensing Mode

Diffuse, Infrared, 940 nm

Range

Special Feature Type	Range		
	90% White Card	18% Gray Card	6% Black Card
S and G	0 to ≥ 120 mm	0 to ≥ 50 mm	≤ 3 to ≥ 30 mm
Y and Z	0 to ≥ 100 mm	0 to ≥ 40 mm	≤ 4 to ≥ 25 mm
W and X	0 to ≥ 85 mm	0 to ≥ 35 mm	≤ 6 to ≥ 20 mm

Operating Conditions

-10 °C to +55 °C (+14 °F to +131 °F)

Environmental Rating

IP50

Vibration and Mechanical Shock

All models meet IEC 60068-2-6, IEC 60947-5-2, UL491 Section 40, MIL-STD-202F, Method 201A (Vibration: 10 Hz to 60 Hz, 0.5 mm peak-to-peak)
 Shock: 30G 11 ms duration, half sine wave per IEC 60068-2-27

Cable

Minimum static bend radius: 20 mm
 Flex life > 10,000 cycles at flexing bend radius > 40 mm

Certifications



Banner Engineering Europe Park Lane,
 Culliganlaan 2F bus 3, 1831 Diegem,
 BELGIUM



Turck Banner LTD Blenheim House,
 Blenheim Court, Wickford, Essex SS11
 8YT, Great Britain



IND. CONT. EQ.
 E224071

Performance Curves



Note: The Beam Pattern and Excess Gain performance curve diagrams represent the Standard Gain (Special Feature S and G) models.

