

TV02W5V0-HF Thru TV02W191-HF

Working Peak Reverse Voltage:5.0-190 Volts

Peak Pulse Power:200 Watts

RoHS Device

Halogen Free

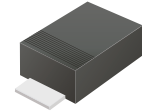

Features

- Glass passivated chip.
- Low leakage current.
- 200W peak pulse power capility with a 10/1000us waveform,repitive rate (duty cycle):0.01%.
- Uni and bidirectional unit.
- Excellent clamping capability.
- Very fast response time.

Mechanical data

- Case: Molded plastic.
- Epoxy: UL 94V-0 rate flame retardant.
- Lead: Solderable per MIL-STD-750, method 2026.
- Polarity: Color band denotes cathode end except bipolar.
- Mounting position: Any.
- Weight: 0.016 grams(approx.).



Circuit Diagram

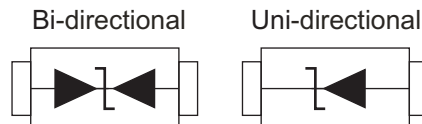

Maximum Rating and Electrical Characteristics

Ratings at 25°C ambient temperature unless otherwise specified.
Single phase, half wave, 60Hz, resistive or inductive load.
For capacitive load, derate current by 20%.

Parameter	Symbol	Value	Unit
Peak power dissipation at 10/1000µs waveform (Note 1)	PPP	200	W
Peak power dissipation at 8/20µs waveform (Note 1)	PPP	1000	W
Peak pulse current with a 10/1000µs waveform (Note 1)	IPP	See next table	A
Power dissipation on infinite heatsink at TL = 75°C	PD	0.4	W
Peak forward surge current, 8.3ms single half sone-wave undirestional only (Note 2)	IFSM	20	A
Max.instantaneous forward voltage at 25A for undirestional only	VF	3.5	V
Operating junction and storage temperature range	TJ,TSTG	-55 to +150	°C

Notes:

1. Non-repetitive current pulse, per Fig.3 and derated above TA=25°C per Fig.1
2. Measured on 8.3ms single half sine-wave or equivalent square wave, duty cycle=4 pulses per minute maximum.

Company reserves the right to improve product design , functions and reliability without notice.

REV:C

Rating and Characteristic Curves (TV02W5V0-HF Thru. TV02W191-HF)

Fig. 1 - Pulse Derating Curve

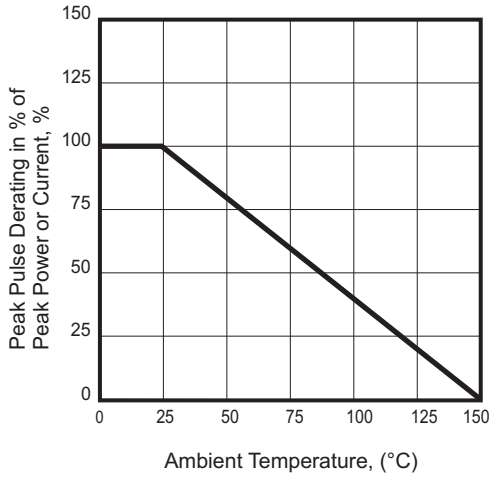

Fig.2 - Steady State Power Derating Curve

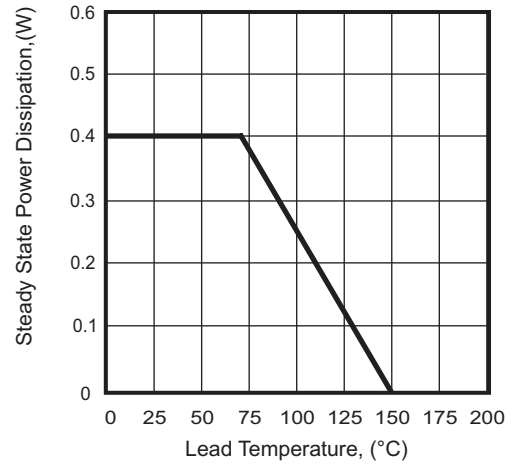

Fig. 3 - Pulse Waveform

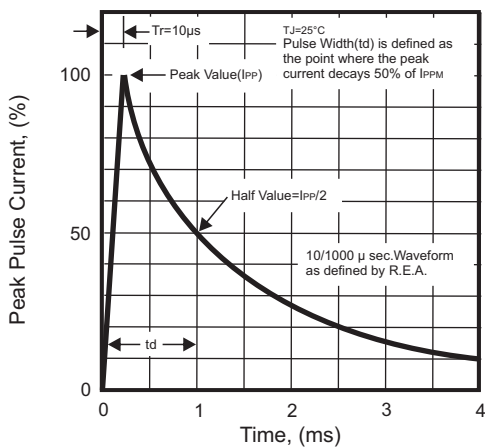

Fig. 4 - Peak Pulse Power Rating Curve

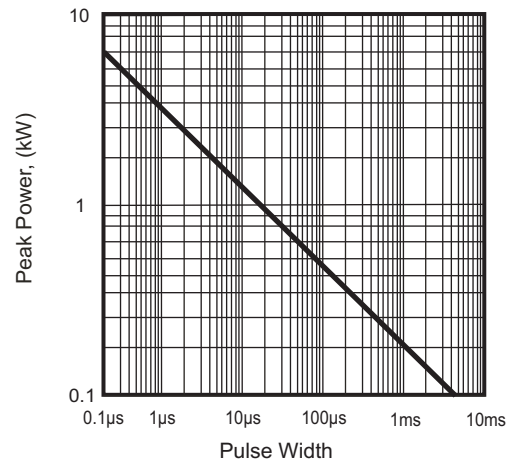

Fig. 5 - Maximum Non-Repetitive Surge Current

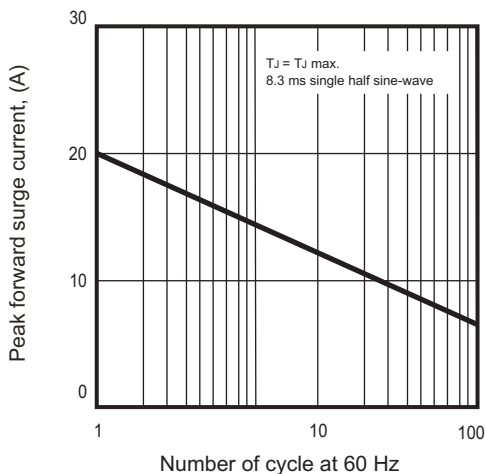
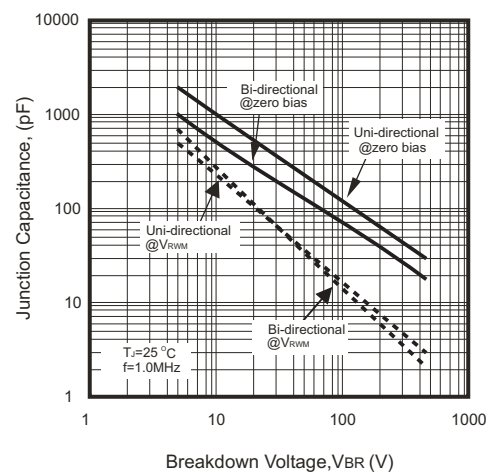

Fig.6 - Typical Junction Capacitance



SMD Transient Voltage Suppressor



Electrical Characteristics (TV02W5V0-HF Thru. TV02W191-HF)

Part No	Absolute Maximum Rating (Ta=25°C)				Vc (Max.) @ IPP	IPP (Max.) @ 10/1000us	IR (Max.) @ VRWM	Marking Code	
	VRWM	VBR Min.	VBR Max.	IT				Uni	Bi
	(V)	(V)	(V)	(mA)					
TV02W5V0(B)-HF	5.0	6.40	7.00	10	9.20	21.74	400	FE	KE
TV02W6V0(B)-HF	6.0	6.67	7.37	10	10.3	19.42	400	FG	KG
TV02W6V5(B)-HF	6.5	7.22	7.98	10	11.2	17.86	250	FK	KK
TV02W7V0(B)-HF	7.0	7.78	8.60	10	12.0	16.67	100	FM	KM
TV02W7V5(B)-HF	7.5	8.33	9.21	1	12.9	15.50	50	FP	KP
TV02W8V0(B)-HF	8.0	8.89	9.83	1	13.6	14.71	25	FR	KR
TV02W8V5(B)-HF	8.5	9.44	10.40	1	14.4	13.89	10	FT	KT
TV02W9V0(B)-HF	9.0	10.00	11.10	1	15.4	12.99	5	FV	KV
TV02W100(B)-HF	10.0	11.10	12.30	1	17.0	11.76	2.5	FX	KX
TV02W110(B)-HF	11.0	12.20	13.50	1	18.2	10.99	2.5	FZ	KZ
TV02W120(B)-HF	12.0	13.30	14.70	1	19.9	10.05	2.5	HE	LE
TV02W130(B)-HF	13.0	14.40	15.90	1	21.5	9.30	1	HG	LG
TV02W140(B)-HF	14.0	15.60	17.20	1	23.2	8.62	1	HK	LK
TV02W150(B)-HF	15.0	16.70	18.50	1	24.4	8.20	1	HM	LM
TV02W160(B)-HF	16.0	17.80	19.70	1	26.0	7.69	1	HP	LP
TV02W170(B)-HF	17.0	18.90	20.90	1	27.6	7.25	1	HR	LR
TV02W180(B)-HF	18.0	20.00	22.10	1	29.2	6.85	1	HT	LT
TV02W190(B)-HF	19.0	21.10	23.30	1	30.6	6.54	1	HB	LB
TV02W200(B)-HF	20.0	22.20	24.50	1	32.4	6.17	1	HV	LV
TV02W220(B)-HF	22.0	24.40	26.90	1	35.5	5.63	1	HX	LX
TV02W240(B)-HF	24.0	26.70	29.50	1	38.9	5.14	1	HZ	LZ
TV02W260(B)-HF	26.0	28.90	31.90	1	42.1	4.75	1	JE	ME
TV02W280(B)-HF	28.0	31.10	34.40	1	45.4	4.41	1	JG	MG
TV02W300(B)-HF	30.0	33.30	36.80	1	48.4	4.13	1	JK	MK
TV02W330(B)-HF	33.0	36.70	40.60	1	53.3	3.75	1	JM	MM
TV02W360(B)-HF	36.0	40.00	44.20	1	58.1	3.44	1	JP	MP
TV02W400(B)-HF	40.0	44.40	49.10	1	64.5	3.10	1	JR	MR
TV02W430(B)-HF	43.0	47.80	52.80	1	69.4	2.88	1	JT	MT
TV02W450(B)-HF	45.0	50.00	55.30	1	72.7	2.75	1	JV	MV
TV02W480(B)-HF	48.0	53.30	58.90	1	77.4	2.58	1	JX	MX
TV02W510(B)-HF	51.0	56.70	62.70	1	82.4	2.43	1	JZ	MZ
TV02W540(B)-HF	54.0	60.00	66.30	1	87.1	2.30	1	XE	NE
TV02W580(B)-HF	58.0	64.40	71.20	1	93.6	2.14	1	XG	NG
TV02W600(B)-HF	60.0	66.70	73.70	1	96.8	2.07	1	XK	NK
TV02W640(B)-HF	64.0	71.10	78.60	1	103.0	1.94	1	XM	NM
TV02W700(B)-HF	70.0	77.80	86.00	1	113.0	1.77	1	XP	NP
TV02W750(B)-HF	75.0	83.30	92.10	1	121.0	1.65	1	XR	NR
TV02W780(B)-HF	78.0	86.70	95.80	1	126.0	1.59	1	XT	NT
TV02W800(B)-HF	80.0	88.80	97.60	1	129.0	1.55	1	XB	NB
TV02W850(B)-HF	85.0	94.40	104.00	1	137.0	1.46	1	XV	NV
TV02W900(B)-HF	90.0	100.00	111.00	1	146.0	1.37	1	XX	NX
TV02W101(B)-HF	100.0	111.00	123.00	1	162.0	1.23	1	XZ	NZ
TV02W111(B)-HF	110.0	122.00	135.00	1	177.0	1.13	1	TE	PE
TV02W121(B)-HF	120.0	133.00	147.00	1	193.0	1.04	1	TG	PG
TV02W131(B)-HF	130.0	144.00	159.00	1	209.0	0.96	1	TK	PK
TV02W141(B)-HF	140.0	155.00	171.00	1	224.0	0.89	1	TB	PB
TV02W151(B)-HF	150.0	167.00	185.00	1	243.0	0.82	1	TM	PM
TV02W161(B)-HF	160.0	178.00	197.00	1	259.0	0.77	1	TP	PP
TV02W171(B)-HF	170.0	189.00	209.00	1	275.0	0.73	1	TR	PR
TV02W181(B)-HF	180.0	200.00	220.00	1	292.0	0.68	1	TT	PT
TV02W191(B)-HF	190.0	211.00	232.00	1	308.0	0.65	1	TV	PV

Notes:

1. Suffix B after part number to specify bi-directional devices.
2. For Bi-Directional devices having Vr of 10 volts and under, the Ir limit is double.

Company reserves the right to improve product design , functions and reliability without notice.

REV:C

Reel Taping Specification

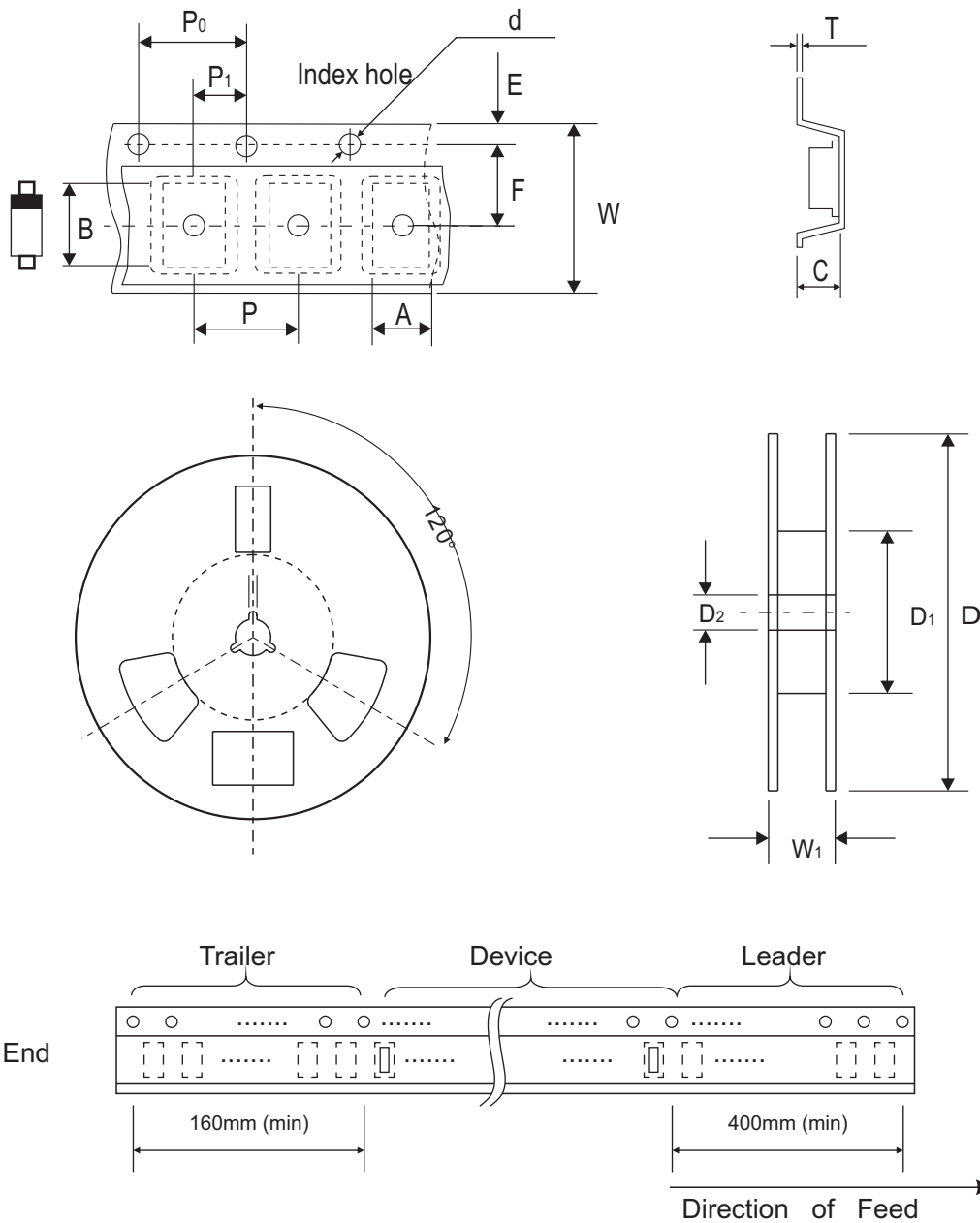

SOD-123	SYMBOL	A	B	C	d	D	D1	D2
	(mm)	1.85 ± 0.10	3.94 ± 0.10	1.57 ± 0.10	1.55 ± 0.05	178.00 ± 1.00	50.00 Min.	13.00 ± 0.20
	(inch)	0.073 ± 0.004	0.155 ± 0.004	0.062 ± 0.004	0.061 ± 0.002	7.008 ± 0.039	1.969 Min.	0.512 ± 0.008

SOD-123	SYMBOL	E	F	P	P0	P1	W	W1
	(mm)	1.75 ± 0.10	3.50 ± 0.05	4.00 ± 0.10	4.00 ± 0.10	2.00 ± 0.05	8.00 ± 0.10	11.40 Max.
	(inch)	0.069 ± 0.004	0.138 ± 0.002	0.157 ± 0.004	0.157 ± 0.004	0.079 ± 0.002	0.315 ± 0.004	0.449 Max.