

TV06B5V0-HF Thru. TV06B441-HF

Working Peak Reverse voltage: 5.0 to 440Volts

Power Dissipation: 600 Watts

RoHS Device

Halogen Free

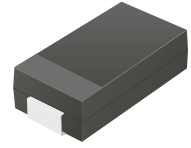

Features

- Glass passivated chip.
- 600W peak pulse power capability with a 10/1000 μ s waveform, repetitive rate (duty cycle): 0.01%.
- Low leakage.
- Uni and Bidirectional unit.
- Excellent clamping capability.
- Very fast response time.
- UL recognized file # E349157  Range: TV06B5V0J(B) thru. TV06B400J(B)

Mechanical Data

- Case: JEDEC DO-214AA, molded plastic.
- Epoxy: UL 94V-0 rate flame retardant.
- Terminals: solderable per MIL-STD-750, method 2026
- Polarity: Color band denotes cathode end except Bipolar.
- Mounting position: Any.
- Weight: 0.108 gram (approx.)

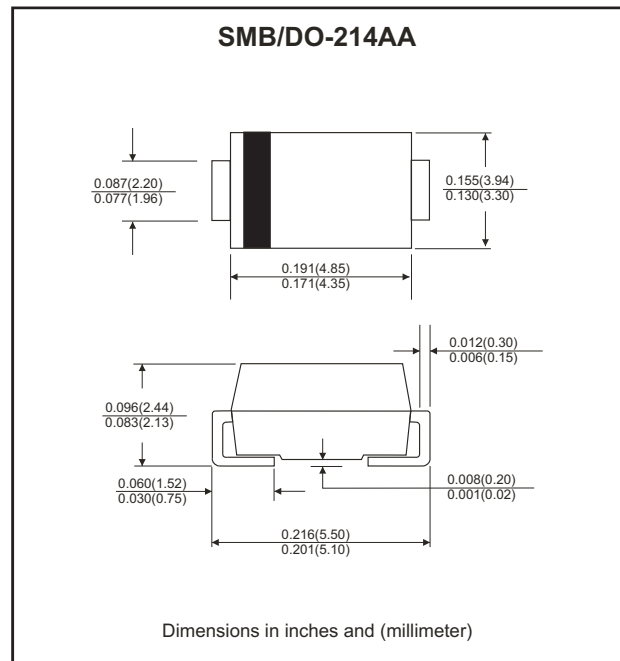

Maximum Ratings and Electrical Characteristics

Rating at 25°C ambient temperature unless otherwise specified.
Single phase, half wave, 60Hz, resistive or inductive load.
For capacitive load, derate current by 20%.

Parameter	Symbol	Value	Units
Peak power dissipation with a 10/1000 μ s waveform (Note 1)	P _{PP}	600	Watts
Peak pulse current with a 10/1000 μ s waveform (Note 1)	I _{PP}	See Next Table	A
Power dissipation on infinite heatsink at T _L =75°C	P _D	5.0	Watts
Peak forward surge current, 8.3ms single half sine-wave unidirectional only (Note 2)	I _{FSM}	100	A
Maximum instantaneous forward voltage at 50 A for unidirectional only (Note 3)	V _F	3.5/5.0	V
Operating junction and Storage temperature range	T _J , T _{STG}	-55 to +150	°C

- Note: 1. Non-repetitive current pulse per Fig. 5 and derated above T_A=25°C per Fig.1
2. Measured on 8.3 ms single half sine-wave or equivalent square wave, duty cycle=4 pulses per minute maximum.
3. V_F<3.5V for devices of V_{BR} <200V and V_F <5.0V for devices of V_{BR} >201V

Company reserves the right to improve product design , functions and reliability without notice.

Rating and Characteristics Curves (TV06B5V0-HF Thru. TV06B441-HF)

Fig.1 - Pulse Derating Curve

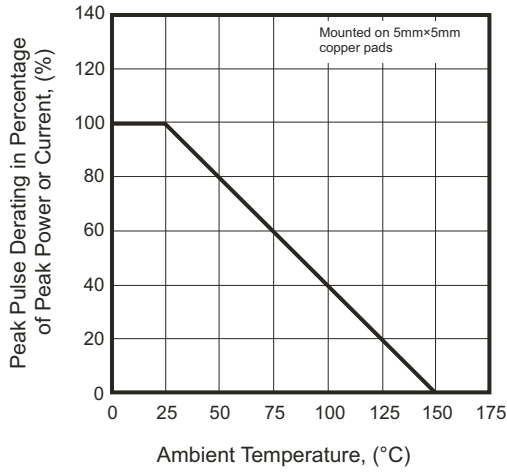

Fig.2 - Max. Non-Repetitive Surge Current

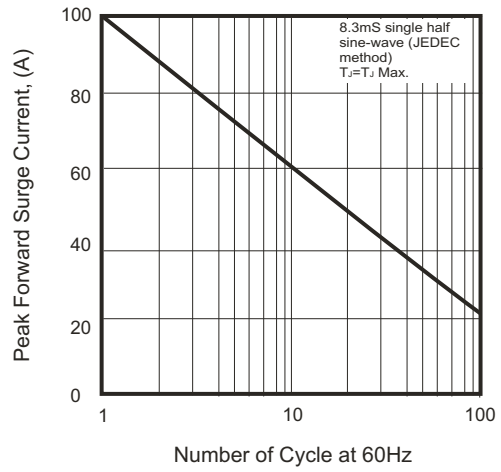

Fig.3 - Steady State Power Derating Curve

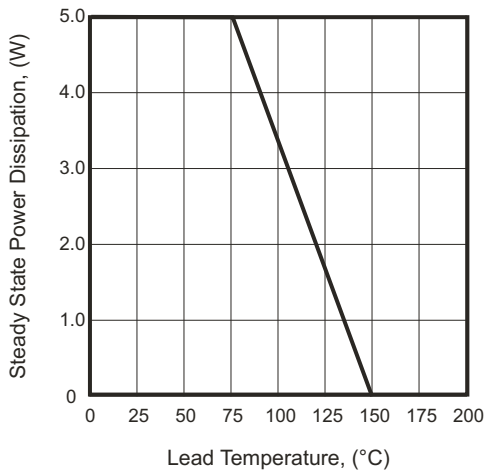

Fig.4 - Peak Pulse Power Rating Curve

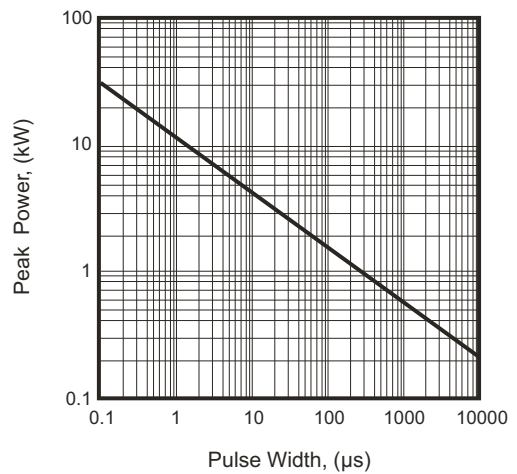

Fig.5 - Pulse Waveform

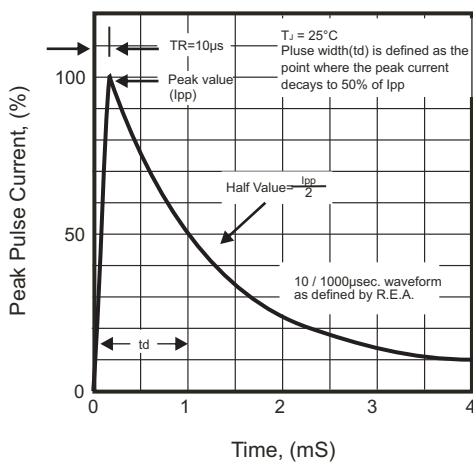
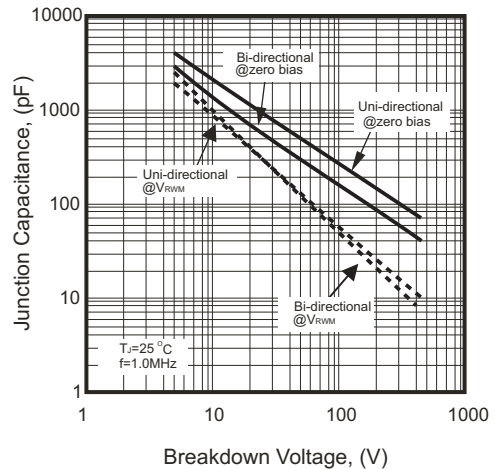

Fig.6 - Typical Junction Capacitance



SMD Transient Voltage Suppressor



Electrical Characteristics (TV06B5V0-HF Thru. TV06B441-HF)

Part No.	Breakdown voltage V _{BR} @ I _T			Maximum Reverse Leakage @V _{RWM} I _R (uA)	Working Peak Reverse Voltage V _{RWM} (V)	Maximum Reverse Surge Current I _{PP} (A)	Maximum Clamping Voltage @I _{PP} V _c (V)	Device Marking Code	
	Min. (V)	Max. (V)	I _T (mA)					UNI	BI
TV06B5V0J(B)-HF	6.40	7.00	10	800	5.0	65.22	9.2	KE	AE
TV06B6V0J(B)-HF	6.67	7.37	10	800	6.0	58.25	10.3	KG	AG
TV06B6V5J(B)-HF	7.22	7.98	10	500	6.5	53.57	11.2	KK	AK
TV06B7V0J(B)-HF	7.78	8.60	10	200	7.0	50.00	12.0	KM	AM
TV06B7V5J(B)-HF	8.33	9.21	1	100	7.5	46.51	12.9	KP	AP
TV06B8V0J(B)-HF	8.89	9.83	1	50	8.0	44.12	13.6	KR	AR
TV06B8V5J(B)-HF	9.44	10.40	1	20	8.5	41.67	14.4	KT	AT
TV06B9V0J(B)-HF	10.00	11.10	1	10	9.0	38.96	15.4	KV	AV
TV06B100J(B)-HF	11.10	12.30	1	5.0	10.0	35.29	17.0	KX	AX
TV06B110J(B)-HF	12.20	13.50	1	1.0	11.0	32.97	18.2	KZ	AZ
TV06B120J(B)-HF	13.30	14.70	1	1.0	12.0	30.15	19.9	LE	BE
TV06B130J(B)-HF	14.40	15.90	1	1.0	13.0	27.91	21.5	LG	BG
TV06B140J(B)-HF	15.60	17.20	1	1.0	14.0	25.86	23.2	LK	BK
TV06B150J(B)-HF	16.70	18.50	1	1.0	15.0	24.59	24.4	LM	BM
TV06B160J(B)-HF	17.80	19.70	1	1.0	16.0	23.08	26.0	LP	BP
TV06B170J(B)-HF	18.90	20.90	1	1.0	17.0	21.74	27.6	LR	BR
TV06B180J(B)-HF	20.00	22.10	1	1.0	18.0	20.55	29.2	LT	BT
TV06B190J(B)-HF	21.10	23.30	1	1.0	19.0	19.49	30.8	LB	BB
TV06B200J(B)-HF	22.20	24.50	1	1.0	20.0	18.52	32.4	LV	BV
TV06B220J(B)-HF	24.40	26.90	1	1.0	22.0	16.90	35.5	LX	BX
TV06B240J(B)-HF	26.70	29.50	1	1.0	24.0	15.42	38.9	LZ	BZ
TV06B260J(B)-HF	28.90	31.90	1	1.0	26.0	14.25	42.1	ME	CE
TV06B280J(B)-HF	31.10	34.40	1	1.0	28.0	13.22	45.4	MG	CG
TV06B300J(B)-HF	33.30	36.80	1	1.0	30.0	12.40	48.4	MK	CK
TV06B330J(B)-HF	36.70	40.60	1	1.0	33.0	11.26	53.3	MM	CM
TV06B360J(B)-HF	40.00	44.20	1	1.0	36.0	10.33	58.1	MP	CP
TV06B400J(B)-HF	44.40	49.10	1	1.0	40.0	9.30	64.5	MR	CR
TV06B430J(B)-HF	47.80	52.80	1	1.0	43.0	8.65	69.4	MT	CT
TV06B450J(B)-HF	50.00	55.30	1	1.0	45.0	8.25	72.7	MV	CV
TV06B480J(B)-HF	53.30	58.90	1	1.0	48.0	7.75	77.4	MX	CX
TV06B510J(B)-HF	56.70	62.70	1	1.0	51.0	7.28	82.4	MZ	CZ
TV06B540J(B)-HF	60.00	66.30	1	1.0	54.0	6.89	87.1	NE	DE
TV06B580J(B)-HF	64.40	71.20	1	1.0	58.0	6.41	93.6	NG	DG
TV06B600J(B)-HF	66.70	73.70	1	1.0	60.0	6.20	96.8	NK	DK
TV06B640J(B)-HF	71.10	78.60	1	1.0	64.0	5.83	103.0	NM	DM
TV06B700J(B)-HF	77.80	86.00	1	1.0	70.0	5.31	113.0	NP	DP
TV06B750J(B)-HF	83.30	92.10	1	1.0	75.0	4.96	121.0	NR	DR
TV06B780J(B)-HF	86.70	95.80	1	1.0	78.0	4.76	126.0	NT	DT
TV06B800J(B)-HF	88.80	97.60	1	1.0	80.0	4.63	129.6	NB	DB
TV06B850J(B)-HF	94.40	104.00	1	1.0	85.0	4.38	137.0	NV	DV
TV06B900J(B)-HF	100.00	111.00	1	1.0	90.0	4.11	146.0	NX	DX
TV06B101J(B)-HF	111.00	123.00	1	1.0	100.0	3.70	162.0	NZ	DZ
TV06B111J(B)-HF	122.00	135.00	1	1.0	110.0	3.39	177.0	PE	EE
TV06B121J(B)-HF	133.00	147.00	1	1.0	120.0	3.11	193.0	PG	EG

Company reserves the right to improve product design , functions and reliability without notice.

REV:D

SMD Transient Voltage Suppressor

Electrical Characteristics (TV06B5V0-HF Thru. TV06B441-HF)

Part No.	Breakdown voltage V _{BR} @ I _T			Maximum Reverse Leakage @V _{RWM} I _R (uA)	Working Peak Reverse Voltage V _{RWM} (V)	Maximum Reverse Surge Current I _{PP} (A)	Maximum Clamping Voltage @I _{PP} V _C (V)	Device Marking Code	
	Min. (V)	Max. (V)	I _T (mA)					UNI	BI
TV06B131J(B)-HF	144.0	159.0	1	1.0	130.0	2.87	209.0	PK	EK
TV06B141J(B)-HF	155.0	171.0	1	1.0	140.0	2.65	226.8	PB	EB
TV06B151J(B)-HF	167.0	185.0	1	1.0	150.0	2.47	243.0	PM	EM
TV06B161J(B)-HF	178.0	197.0	1	1.0	160.0	2.32	259.0	PP	EP
TV06B171J(B)-HF	189.0	209.0	1	1.0	170.0	2.18	275.0	PR	ER
TV06B181J(B)-HF	200.0	220.0	1	1.0	180.0	2.06	291.6	PT	ET
TV06B191J(B)-HF	211.0	232.0	1	1.0	190.0	1.95	307.8	PV	EV
TV06B201J(B)-HF	224.0	247.0	1	1.0	200.0	1.85	324.0	PW	EW
TV06B221J(B)-HF	246.0	272.0	1	1.0	220.0	1.69	356.0	PX	EX
TV06B251J(B)-HF	279.0	309.0	1	1.0	250.0	1.48	405.0	PZ	EZ
TV06B301J(B)-HF	335.0	371.0	1	1.0	300.0	1.23	486.0	QE	FE
TV06B351J(B)-HF	391.0	432.0	1	1.0	350.0	1.06	567.0	QG	FG
TV06B401J(B)-HF	447.0	494.0	1	1.0	400.0	0.93	648.0	QK	FK
TV06B441J(B)-HF	492.0	543.0	1	1.0	440.0	0.84	713.0	QM	FM

Note:

- 1) Suffix J denotes 5% tolerance devices.
- 2) Suffix B after part number to specify Bi-directional devices.
- 3) For Bi-Directional devices having V_R of 10 volts and under, the I_R limit is double.

Reel Taping Specification

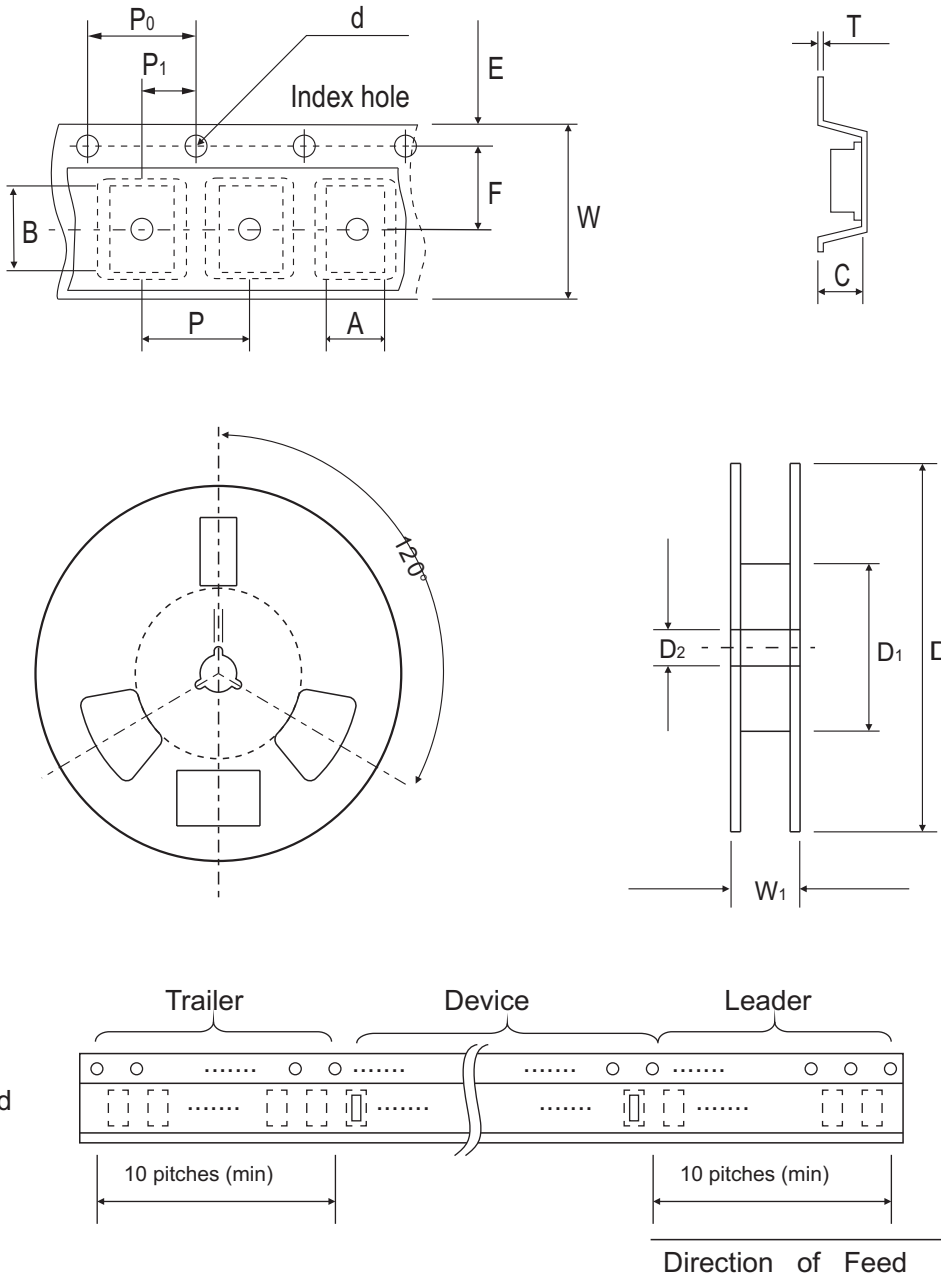

DO-214AA (SMB)	SYMBOL	A	B	C	d	D	D1	D2
	(mm)	3.67 ± 0.10	5.69 ± 0.10	4.50 (max)	1.55 ± 0.10	330.00	50.00 (min)	13.00 ± 0.20
	(inch)	0.144 ± 0.004	0.224 ± 0.004	0.177 (max)	0.061 ± 0.004	13.000	1.969 (min)	0.512 ± 0.008

DO-214AA (SMB)	SYMBOL	E	F	P	P0	P1	W	W1
	(mm)	1.75 ± 0.10	5.50 ± 0.05	8.00 ± 0.10	4.00 ± 0.10	2.00 ± 0.05	12.00 ± 0.30	18.40 (max)
	(inch)	0.069 ± 0.004	0.217 ± 0.002	0.315 ± 0.004	0.157 ± 0.004	0.079 ± 0.002	0.472 ± 0.012	0.724 (max)

Company reserves the right to improve product design, functions and reliability without notice.