

SMD Transient Voltage Suppressor

TV15C5V0-G Thru. TV15C441-G

Working Peak Reverse Voltage: 5.0 to 440 Volts

Power Dissipation: 1500Watts

RoHS Device

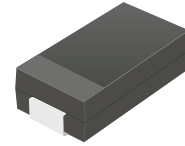

Features

- Glass passivated chip.
- 1500W peak pulse power capability with a 10/1000 μ s waveform, repetitive rate (duty cycle):0.01%
- Low leakage.
- Uni and Bidirectional unit.
- Excellent clamping capability.
- Very fast response time.
- UL recognized file # E349157  Range: TV15C5V0J(B) thru. TV15C101J(B)

Mechanical Data

- Case: DO-214AB/SMC molded plastic.
- Epoxy: UL 94V-0 rate flame retardant
- Terminals: Solderable per MIL-STD-750, method 2026.
- Polarity: Color band denoted cathode end except bipolar.
- Weight: 0.230 gram (approx.)

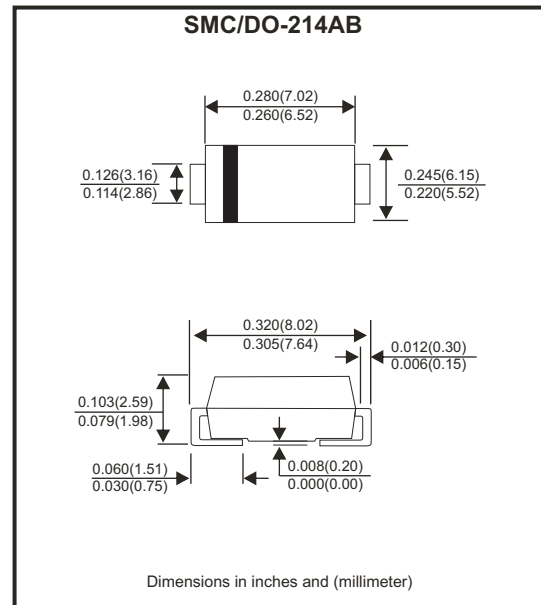

Circuit Diagram



Maximum Ratings and Electrical Characteristics

Rating at 25°C ambient temperature unless otherwise specified.
Single phase, half wave, 60Hz, resistive or inductive load.
For capacitive load, derate current by 20%.

| Characteristics | Symbol | Value | Units |
|--|------------------|-------------|-------|
| Peak power dissipation at 10/1000 μ S waveform (Notes.1) | P _{PPM} | 1500 | W |
| Peak pulse current at 10/1000 μ S waveform (Notes.1) | I _{PPM} | See table 1 | A |
| Steady state power dissipation at T _L =75°C | P _D | 6.5 | W |
| Peak forward surge current, 8.3ms single half sine-wave superimposed on rated load, uni-directional only (Notes.2) | I _{FSM} | 200 | A |
| Maximum instantaneous forward voltage at 100A for uni-directional only (Note.3) | V _F | 3.5/5.0 | V |
| Operation junction temperature range | T _J | -55 to +150 | °C |
| Storage temperature range | T _{STG} | -55 to +150 | °C |

Notes:

1. Non-repetitive current pulse, per Fig. 5 and derated above T_A=25 °C, per Fig. 1
2. Measured on 8.3 ms single half sine-wave or equivalent square wave,duty cycle=4 pulses per minute maximum.
3. V_F<3.5V for devices of V_{BR}<200V and V_F<5.0V for devices of V_{BR}>201V

Company reserves the right to improve product design , functions and reliability without notice.

REV:F

Ratings and Characteristics Curve (TV15C5V0-G Thru. TV15C441-G)

Fig.1 - Pulse Derating Curve



Fig.2 - Max. Non-Repetitive Surge Current

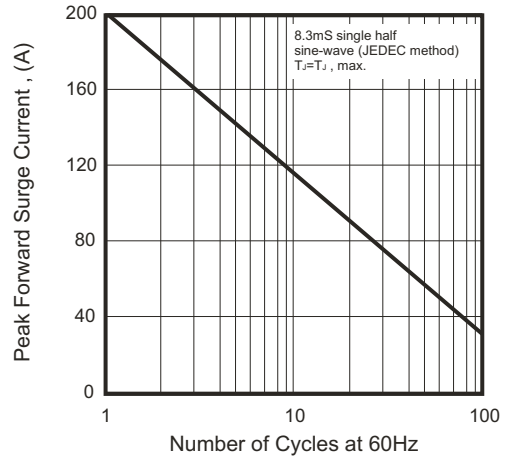

Fig.3 - Steady State Power Derating Curve

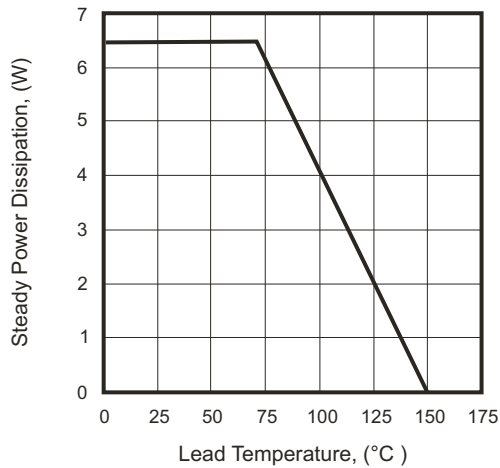

Fig.4 - Peak Pulse Power Rating Curve

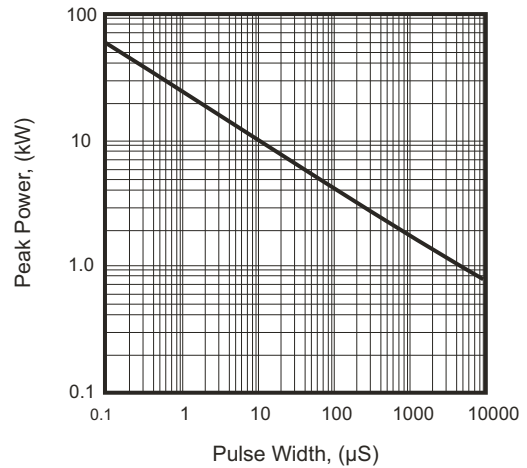

Fig.5 - Pulse Waveform

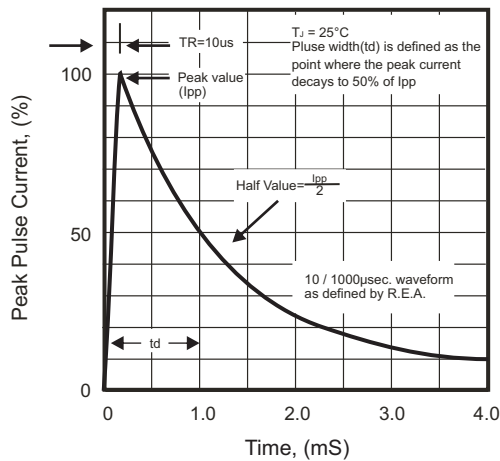
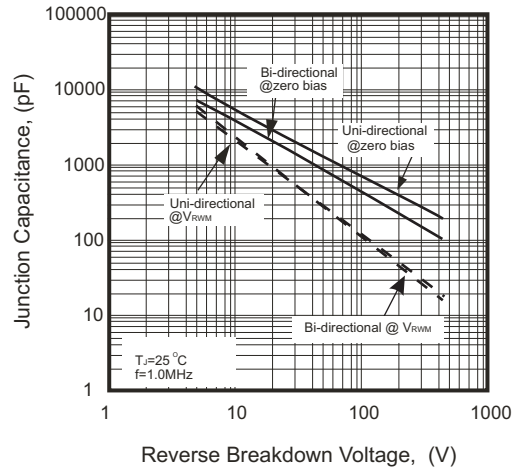

Fig.6 - Typical Junction Capacitance



SMD Transient Voltage Suppressor



Electrical Characteristics (TV15C5V0-G Thru. TV15C441-G)

| Part No. | Breakdown voltage V _{BR} @ I _T | | | Maximum Reverse Leakage @V _{RRM} I _R (uA) | Working Peak Reverse Voltage V _{RRM} (V) | Maximum Reverse Surge Current I _{PP} (A) | Maximum Clamping Voltage @I _{PP} V _c (V) | Device Marking Code | |
|----------------|---|-------------|------------------------|---|---|---|--|---------------------------|-----|
| | Min. (V) | Max. (V) | I _T (mA) | | | | | UNI | BI |
| TV15C5V0J(B)-G | 6.40 | 7.00 | 10 | 800 | 5.0 | 163.04 | 9.2 | GDE | BDE |
| TV15C6V0J(B)-G | 6.67 | 7.37 | 10 | 800 | 6.0 | 145.63 | 10.3 | GDG | BDG |
| TV15C6V5J(B)-G | 7.22 | 7.98 | 10 | 500 | 6.5 | 133.93 | 11.2 | GDK | BDK |
| TV15C7V0J(B)-G | 7.78 | 8.60 | 10 | 200 | 7.0 | 125.00 | 12.0 | GDM | BDM |
| TV15C7V5J(B)-G | 8.33 | 9.21 | 1 | 100 | 7.5 | 116.28 | 12.9 | GDP | BDP |
| TV15C8V0J(B)-G | 8.89 | 9.83 | 1 | 50 | 8.0 | 110.29 | 13.6 | GDR | BDR |
| TV15C8V5J(B)-G | 9.44 | 10.40 | 1 | 20 | 8.5 | 104.17 | 14.4 | GDT | BDT |
| TV15C9V0J(B)-G | 10.00 | 11.10 | 1 | 10 | 9.0 | 97.40 | 15.4 | GDV | BDV |
| TV15C100J(B)-G | 11.10 | 12.30 | 1 | 5.0 | 10.0 | 88.24 | 17.0 | GDX | BDX |
| TV15C110J(B)-G | 12.20 | 13.50 | 1 | 1.0 | 11.0 | 82.42 | 18.2 | GDZ | BDZ |
| TV15C120J(B)-G | 13.30 | 14.70 | 1 | 1.0 | 12.0 | 75.38 | 19.9 | GEE | BEE |
| TV15C130J(B)-G | 14.40 | 15.90 | 1 | 1.0 | 13.0 | 69.77 | 21.5 | GEG | BEG |
| TV15C140J(B)-G | 15.60 | 17.20 | 1 | 1.0 | 14.0 | 64.66 | 23.2 | GEK | BEK |
| TV15C150J(B)-G | 16.70 | 18.50 | 1 | 1.0 | 15.0 | 61.48 | 24.4 | GEM | BEM |
| TV15C160J(B)-G | 17.80 | 19.70 | 1 | 1.0 | 16.0 | 57.69 | 26.0 | GEP | BEP |
| TV15C170J(B)-G | 18.90 | 20.90 | 1 | 1.0 | 17.0 | 54.35 | 27.6 | GER | BER |
| TV15C180J(B)-G | 20.00 | 22.10 | 1 | 1.0 | 18.0 | 51.37 | 29.2 | GET | BET |
| TV15C190J(B)-G | 21.10 | 23.30 | 1 | 1.0 | 19.0 | 48.73 | 30.8 | GEB | BEB |
| TV15C200J(B)-G | 22.20 | 24.50 | 1 | 1.0 | 20.0 | 46.30 | 32.4 | GEV | BEV |
| TV15C220J(B)-G | 24.40 | 26.90 | 1 | 1.0 | 22.0 | 42.25 | 35.5 | GEX | BEX |
| TV15C240J(B)-G | 26.70 | 29.50 | 1 | 1.0 | 24.0 | 38.56 | 38.9 | GEZ | BEZ |
| TV15C260J(B)-G | 28.90 | 31.90 | 1 | 1.0 | 26.0 | 35.63 | 42.1 | GFE | BFE |
| TV15C280J(B)-G | 31.10 | 34.40 | 1 | 1.0 | 28.0 | 33.04 | 45.4 | GFG | BFG |
| TV15C300J(B)-G | 33.30 | 36.80 | 1 | 1.0 | 30.0 | 30.99 | 48.4 | GFK | BFK |
| TV15C330J(B)-G | 36.70 | 40.60 | 1 | 1.0 | 33.0 | 28.14 | 53.3 | GFM | BFM |
| TV15C360J(B)-G | 40.00 | 44.20 | 1 | 1.0 | 36.0 | 25.82 | 58.1 | GFP | BFP |
| TV15C400J(B)-G | 44.40 | 49.10 | 1 | 1.0 | 40.0 | 23.26 | 64.5 | GFR | BFR |
| TV15C430J(B)-G | 47.80 | 52.80 | 1 | 1.0 | 43.0 | 21.61 | 69.4 | GFT | BFT |
| TV15C450J(B)-G | 50.00 | 55.30 | 1 | 1.0 | 45.0 | 20.63 | 72.7 | GFV | BFV |
| TV15C480J(B)-G | 53.30 | 58.90 | 1 | 1.0 | 48.0 | 19.38 | 77.4 | GFX | BFX |
| TV15C510J(B)-G | 56.70 | 62.70 | 1 | 1.0 | 51.0 | 18.20 | 82.4 | GFZ | BFZ |
| TV15C540J(B)-G | 60.00 | 66.30 | 1 | 1.0 | 54.0 | 17.22 | 87.1 | GGE | BGE |
| TV15C580J(B)-G | 64.40 | 71.20 | 1 | 1.0 | 58.0 | 16.03 | 93.6 | GGG | BGG |
| TV15C600J(B)-G | 66.70 | 73.70 | 1 | 1.0 | 60.0 | 15.50 | 96.8 | GGK | BGK |
| TV15C640J(B)-G | 71.10 | 78.60 | 1 | 1.0 | 64.0 | 14.56 | 103.0 | GGM | BGM |
| TV15C700J(B)-G | 77.80 | 86.00 | 1 | 1.0 | 70.0 | 13.27 | 113.0 | GGP | BGP |
| TV15C750J(B)-G | 83.30 | 92.10 | 1 | 1.0 | 75.0 | 12.40 | 121.0 | GGR | BGR |
| TV15C780J(B)-G | 86.70 | 95.80 | 1 | 1.0 | 78.0 | 11.90 | 126.0 | GGT | BGT |
| TV15C800J(B)-G | 88.80 | 97.60 | 1 | 1.0 | 80.0 | 11.57 | 129.6 | GGB | BGB |
| TV15C850J(B)-G | 94.40 | 104.00 | 1 | 1.0 | 85.0 | 10.95 | 137.0 | GGV | BGV |
| TV15C900J(B)-G | 100.00 | 111.00 | 1 | 1.0 | 90.0 | 10.27 | 146.0 | GGX | BGX |
| TV15C101J(B)-G | 111.00 | 123.00 | 1 | 1.0 | 100.0 | 9.26 | 162.0 | GGZ | BGZ |
| TV15C111J(B)-G | 122.00 | 135.00 | 1 | 1.0 | 110.0 | 8.47 | 177.0 | GHE | BHE |
| TV15C121J(B)-G | 133.00 | 147.00 | 1 | 1.0 | 120.0 | 7.77 | 193.0 | GHG | BHG |

Company reserves the right to improve product design , functions and reliability without notice.

REV:F

SMD Transient Voltage Suppressor

Electrical Characteristics (TV15C5V0-G Thru. TV15C441-G)

| Part No. | Breakdown voltage V _{BR} @ I _T | | | Maximum Reverse Leakage @V _{RWM} I _R (uA) | Working Peak Reverse Voltage V _{RWM} (V) | Maximum Reverse Surge Current I _{PP} (A) | Maximum Clamping Voltage @I _{PP} V _c (V) | Device Marking Code | |
|----------------|---|-------------|------------------------|---|---|---|--|---------------------------|-----|
| | Min. (V) | Max. (V) | I _T (mA) | | | | | UNI | BI |
| TV15C131J(B)-G | 144.0 | 159.0 | 1 | 1.0 | 130.0 | 7.18 | 209.0 | GHK | BHK |
| TV15C141J(B)-G | 155.0 | 171.0 | 1 | 1.0 | 140.0 | 6.61 | 226.8 | GHB | BHB |
| TV15C151J(B)-G | 167.0 | 185.0 | 1 | 1.0 | 150.0 | 6.17 | 243.0 | GHM | BHM |
| TV15C161J(B)-G | 178.0 | 197.0 | 1 | 1.0 | 160.0 | 5.79 | 259.0 | GHP | BHP |
| TV15C171J(B)-G | 189.0 | 209.0 | 1 | 1.0 | 170.0 | 5.45 | 275.0 | GHR | BHR |
| TV15C181J(B)-G | 200.0 | 220.0 | 1 | 1.0 | 180.0 | 5.14 | 291.6 | GHT | BHT |
| TV15C191J(B)-G | 211.0 | 232.0 | 1 | 1.0 | 190.0 | 4.87 | 307.8 | GHV | BHV |
| TV15C201J(B)-G | 224.0 | 247.0 | 1 | 1.0 | 200.0 | 4.60 | 324.0 | GHW | BHW |
| TV15C221J(B)-G | 246.0 | 272.0 | 1 | 1.0 | 220.0 | 4.20 | 356.0 | GHX | BHX |
| TV15C251J(B)-G | 279.0 | 309.0 | 1 | 1.0 | 250.0 | 3.70 | 405.0 | GHZ | BHZ |
| TV15C301J(B)-G | 335.0 | 371.0 | 1 | 1.0 | 300.0 | 3.10 | 486.0 | GJE | BJE |
| TV15C351J(B)-G | 391.0 | 432.0 | 1 | 1.0 | 350.0 | 2.60 | 567.0 | GJG | BJG |
| TV15C401J(B)-G | 447.0 | 494.0 | 1 | 1.0 | 400.0 | 2.30 | 648.0 | GJK | BJK |
| TV15C441J(B)-G | 492.0 | 543.0 | 1 | 1.0 | 440.0 | 2.10 | 713.0 | GJM | BJM |

Note:

- 1) Suffix J denotes 5% tolerance devices.
- 2) Suffix B after part number to specify Bi-directional devices.
- 3) For Bi-Directional devices having V_R of 10 volts and under, the I_R limit is double.

Reel Taping Specification

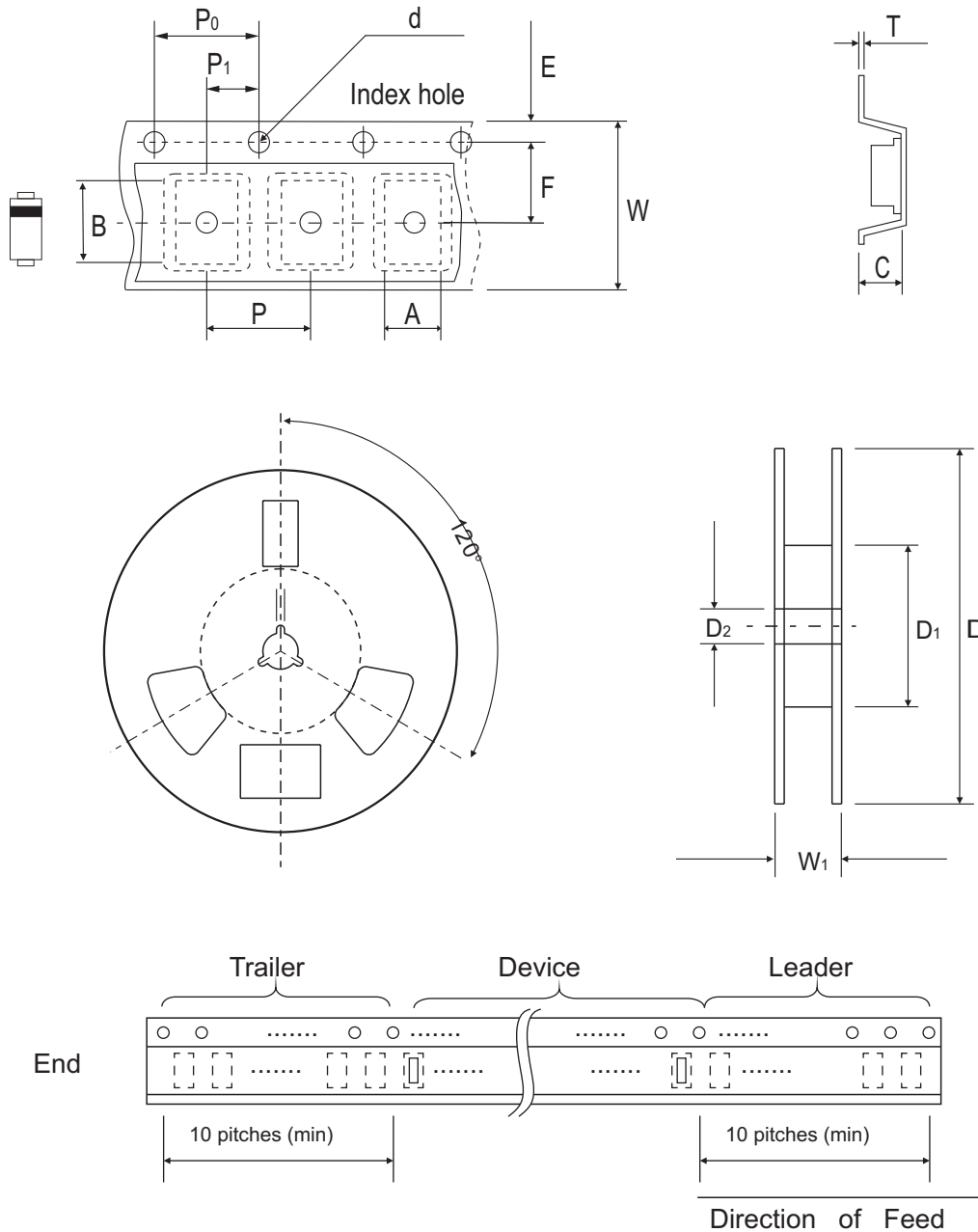

| DO-214AB (SMC) | SYMBOL | A | B | C | d | D | D1 | D2 |
|-------------------|--------|---------------|---------------|-------------|---------------|--------|-------------|---------------|
| | (mm) | 6.05 ± 0.10 | 8.31 ± 0.10 | 3.29 (max) | 1.55 ± 0.10 | 330.00 | 50.00 (min) | 13.00 ± 0.20 |
| | (inch) | 0.238 ± 0.004 | 0.327 ± 0.004 | 0.130 (max) | 0.061 ± 0.004 | 13.000 | 1.969 (min) | 0.512 ± 0.008 |

| DO-214AB (SMC) | SYMBOL | E | F | P | P0 | P1 | W | W1 |
|-------------------|--------|---------------|---------------|---------------|---------------|---------------|---------------|-------------|
| | (mm) | 1.75 ± 0.10 | 7.50 ± 0.10 | 8.00 ± 0.10 | 4.00 ± 0.10 | 2.00 ± 0.10 | 16.00 ± 0.30 | 22.40 (max) |
| | (inch) | 0.069 ± 0.004 | 0.295 ± 0.004 | 0.315 ± 0.004 | 0.157 ± 0.004 | 0.079 ± 0.004 | 0.630 ± 0.012 | 0.882 (max) |

Company reserves the right to improve product design, functions and reliability without notice.

REV:F