

# SMD Transient Voltage Suppressor

## TV15C5V0-G Thru. TV15C441-G

Working Peak Reverse Voltage: 5.0 to 440 Volts

Power Dissipation: 1500Watts

RoHS Device

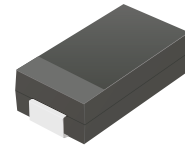

### Features

- Glass passivated chip.
- 1500W peak pulse power capability with a 10/1000µs waveform, repetitive rate (duty cycle):0.01%
- Low leakage.
- Uni and Bidirectional unit.
- Excellent clamping capability.
- Very fast response time.
- UL recognized file # E349157  Range: TV15C5V0J(B) thru. TV15C101J(B)

### Mechanical Data

- Case: DO-214AB/SMC molded plastic.
- Epoxy: UL 94V-0 rate flame retardant
- Terminals: Solderable per MIL-STD-750, method 2026.
- Polarity: Color band denoted cathode end except bipolar.
- Weight: 0.230 gram (approx.)

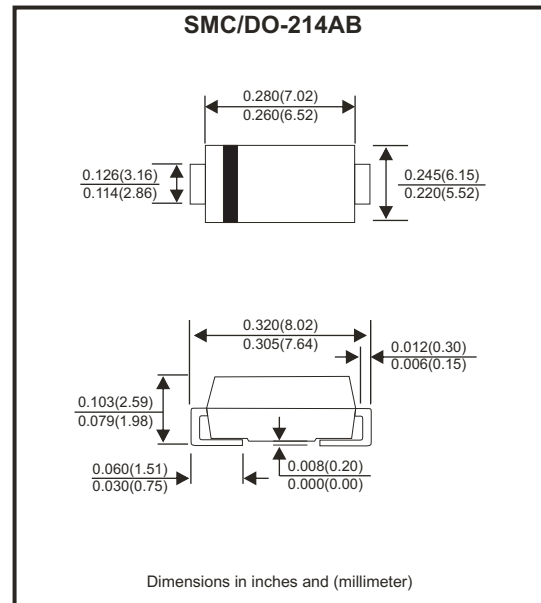

### Circuit Diagram

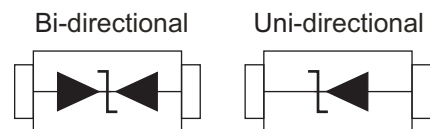

### Maximum Ratings and Electrical Characteristics

Rating at 25°C ambient temperature unless otherwise specified.  
Single phase, half wave, 60Hz, resistive or inductive load.  
For capacitive load, derate current by 20%.

Characteristics	Symbol	Value	Units
Peak power dissipation at 10/1000µs waveform (Notes.1)	P <sub>PPM</sub>	1500	W
Peak pulse current at 10/1000µs waveform (Notes.1)	I <sub>PPM</sub>	See table 1	A
Steady state power dissipation at T <sub>L</sub> =75°C	P <sub>D</sub>	6.5	W
Peak forward surge current, 8.3ms single half sine-wave superimposed on rated load, uni-directional only (Notes.2)	I <sub>FSM</sub>	200	A
Maximum instantaneous forward voltage at 100A for uni-directional only (Note.3)	V <sub>F</sub>	3.5/5.0	V
Operation junction temperature range	T <sub>J</sub>	-55 to +150	°C
Storage temperature range	T <sub>STG</sub>	-55 to +150	°C

Notes:

1. Non-repetitive current pulse, per Fig. 5 and derated above T<sub>A</sub>=25 °C, per Fig. 1
2. Measured on 8.3 ms single half sine-wave or equivalent square wave,duty cycle=4 pulses per minute maximum.
3. V<sub>F</sub><3.5V for devices of V<sub>BR</sub><200V and V<sub>F</sub><5.0V for devices of V<sub>BR</sub>>201V

Company reserves the right to improve product design , functions and reliability without notice.

REV:F

## Ratings and Characteristics Curve (TV15C5V0-G Thru. TV15C441-G)

Fig.1 - Pulse Derating Curve

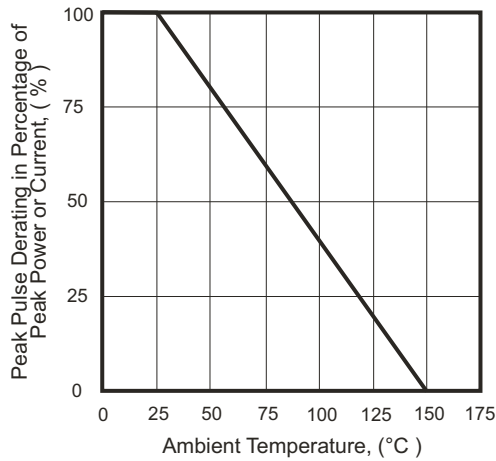

Fig.2 - Max. Non-Repetitive Surge Current

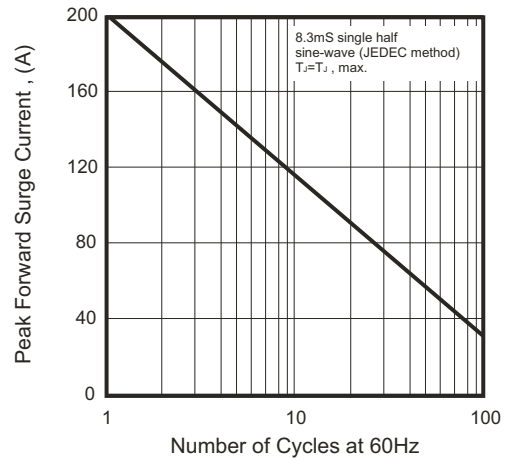

Fig.3 - Steady State Power Derating Curve

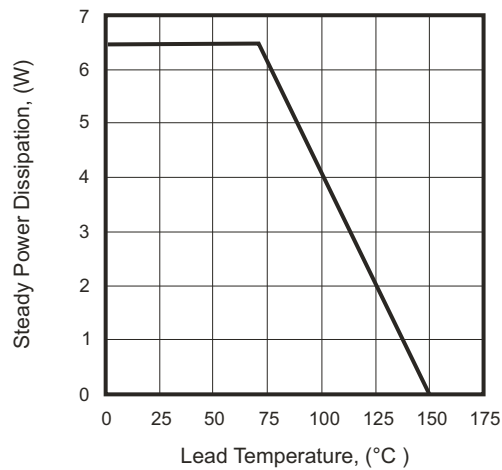

Fig.4 - Peak Pulse Power Rating Curve

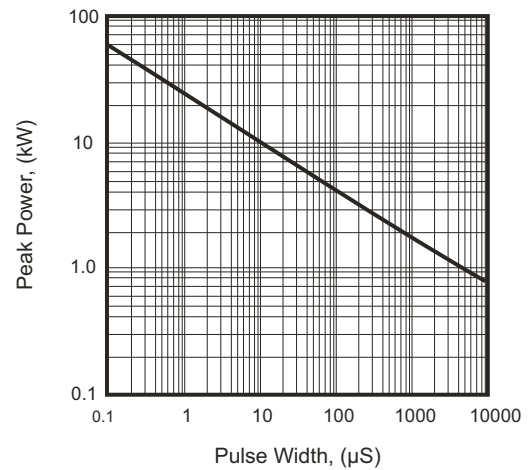

Fig.5 - Pulse Waveform

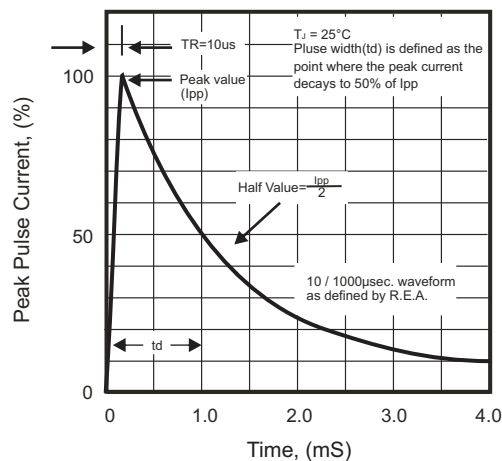
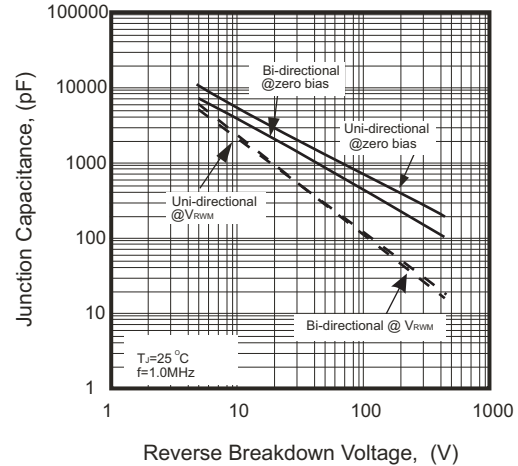

Fig.6 - Typical Junction Capacitance



Company reserves the right to improve product design, functions and reliability without notice.

REV:F

# SMD Transient Voltage Suppressor



## Electrical Characteristics (TV15C5V0-G Thru. TV15C441-G)

Part No.	Breakdown voltage V <sub>BR</sub> @ I <sub>T</sub>			Maximum Reverse Leakage @V <sub>RRM</sub> I <sub>R</sub> (uA)	Working Peak Reverse Voltage V <sub>RRM</sub> (V)	Maximum Reverse Surge Current I <sub>PP</sub> (A)	Maximum Clamping Voltage @I <sub>PP</sub> V <sub>c</sub> (V)	Device Marking Code	
	Min. (V)	Max. (V)	I <sub>T</sub> (mA)					UNI	BI
TV15C5V0J(B)-G	6.40	7.00	10	800	5.0	163.04	9.2	GDE	BDE
TV15C6V0J(B)-G	6.67	7.37	10	800	6.0	145.63	10.3	GDG	BDG
TV15C6V5J(B)-G	7.22	7.98	10	500	6.5	133.93	11.2	GDK	BDK
TV15C7V0J(B)-G	7.78	8.60	10	200	7.0	125.00	12.0	GDM	BDM
TV15C7V5J(B)-G	8.33	9.21	1	100	7.5	116.28	12.9	GDP	BDP
TV15C8V0J(B)-G	8.89	9.83	1	50	8.0	110.29	13.6	GDR	BDR
TV15C8V5J(B)-G	9.44	10.40	1	20	8.5	104.17	14.4	GDT	BDT
TV15C9V0J(B)-G	10.00	11.10	1	10	9.0	97.40	15.4	GDV	BDV
TV15C100J(B)-G	11.10	12.30	1	5.0	10.0	88.24	17.0	GDX	BDX
TV15C110J(B)-G	12.20	13.50	1	1.0	11.0	82.42	18.2	GDZ	BDZ
TV15C120J(B)-G	13.30	14.70	1	1.0	12.0	75.38	19.9	GEE	BEE
TV15C130J(B)-G	14.40	15.90	1	1.0	13.0	69.77	21.5	GEG	BEG
TV15C140J(B)-G	15.60	17.20	1	1.0	14.0	64.66	23.2	GEK	BEK
TV15C150J(B)-G	16.70	18.50	1	1.0	15.0	61.48	24.4	GEM	BEM
TV15C160J(B)-G	17.80	19.70	1	1.0	16.0	57.69	26.0	GEP	BEP
TV15C170J(B)-G	18.90	20.90	1	1.0	17.0	54.35	27.6	GER	BER
TV15C180J(B)-G	20.00	22.10	1	1.0	18.0	51.37	29.2	GET	BET
TV15C190J(B)-G	21.10	23.30	1	1.0	19.0	48.73	30.8	GEB	BEB
TV15C200J(B)-G	22.20	24.50	1	1.0	20.0	46.30	32.4	GEV	BEV
TV15C220J(B)-G	24.40	26.90	1	1.0	22.0	42.25	35.5	GEX	BEX
TV15C240J(B)-G	26.70	29.50	1	1.0	24.0	38.56	38.9	GEZ	BEZ
TV15C260J(B)-G	28.90	31.90	1	1.0	26.0	35.63	42.1	GFE	BFE
TV15C280J(B)-G	31.10	34.40	1	1.0	28.0	33.04	45.4	GFG	BFG
TV15C300J(B)-G	33.30	36.80	1	1.0	30.0	30.99	48.4	GFK	BFK
TV15C330J(B)-G	36.70	40.60	1	1.0	33.0	28.14	53.3	GFM	BFM
TV15C360J(B)-G	40.00	44.20	1	1.0	36.0	25.82	58.1	GFP	BFP
TV15C400J(B)-G	44.40	49.10	1	1.0	40.0	23.26	64.5	GFR	BFR
TV15C430J(B)-G	47.80	52.80	1	1.0	43.0	21.61	69.4	GFT	BFT
TV15C450J(B)-G	50.00	55.30	1	1.0	45.0	20.63	72.7	GFV	BFV
TV15C480J(B)-G	53.30	58.90	1	1.0	48.0	19.38	77.4	GFX	BFX
TV15C510J(B)-G	56.70	62.70	1	1.0	51.0	18.20	82.4	GFZ	BFZ
TV15C540J(B)-G	60.00	66.30	1	1.0	54.0	17.22	87.1	GGE	BGE
TV15C580J(B)-G	64.40	71.20	1	1.0	58.0	16.03	93.6	GGG	BGG
TV15C600J(B)-G	66.70	73.70	1	1.0	60.0	15.50	96.8	GGK	BGK
TV15C640J(B)-G	71.10	78.60	1	1.0	64.0	14.56	103.0	GGM	BGM
TV15C700J(B)-G	77.80	86.00	1	1.0	70.0	13.27	113.0	GGP	BGP
TV15C750J(B)-G	83.30	92.10	1	1.0	75.0	12.40	121.0	GGR	BGR
TV15C780J(B)-G	86.70	95.80	1	1.0	78.0	11.90	126.0	GGT	BGT
TV15C800J(B)-G	88.80	97.60	1	1.0	80.0	11.57	129.6	GGB	BGB
TV15C850J(B)-G	94.40	104.00	1	1.0	85.0	10.95	137.0	GGV	BGV
TV15C900J(B)-G	100.00	111.00	1	1.0	90.0	10.27	146.0	GGX	BGX
TV15C101J(B)-G	111.00	123.00	1	1.0	100.0	9.26	162.0	GGZ	BGZ
TV15C111J(B)-G	122.00	135.00	1	1.0	110.0	8.47	177.0	GHE	BHE
TV15C121J(B)-G	133.00	147.00	1	1.0	120.0	7.77	193.0	GHG	BHG

Company reserves the right to improve product design , functions and reliability without notice.

REV:F

# SMD Transient Voltage Suppressor

## Electrical Characteristics (TV15C5V0-G Thru. TV15C441-G)

Part No.	Breakdown voltage V <sub>BR</sub> @ I <sub>T</sub>			Maximum Reverse Leakage @V <sub>RWM</sub> I <sub>R</sub> (uA)	Working Peak Reverse Voltage V <sub>RWM</sub> (V)	Maximum Reverse Surge Current I <sub>PP</sub> (A)	Maximum Clamping Voltage @I <sub>PP</sub> V <sub>c</sub> (V)	Device Marking Code	
	Min. (V)	Max. (V)	I <sub>T</sub> (mA)					UNI	BI
TV15C131J(B)-G	144.0	159.0	1	1.0	130.0	7.18	209.0	GHK	BHK
TV15C141J(B)-G	155.0	171.0	1	1.0	140.0	6.61	226.8	GHB	BHB
TV15C151J(B)-G	167.0	185.0	1	1.0	150.0	6.17	243.0	GHM	BHM
TV15C161J(B)-G	178.0	197.0	1	1.0	160.0	5.79	259.0	GHP	BHP
TV15C171J(B)-G	189.0	209.0	1	1.0	170.0	5.45	275.0	GHR	BHR
TV15C181J(B)-G	200.0	220.0	1	1.0	180.0	5.14	291.6	GHT	BHT
TV15C191J(B)-G	211.0	232.0	1	1.0	190.0	4.87	307.8	GHV	BHV
TV15C201J(B)-G	224.0	247.0	1	1.0	200.0	4.60	324.0	GHW	BHW
TV15C221J(B)-G	246.0	272.0	1	1.0	220.0	4.20	356.0	GHX	BHX
TV15C251J(B)-G	279.0	309.0	1	1.0	250.0	3.70	405.0	GHZ	BHZ
TV15C301J(B)-G	335.0	371.0	1	1.0	300.0	3.10	486.0	GJE	BJE
TV15C351J(B)-G	391.0	432.0	1	1.0	350.0	2.60	567.0	GJG	BJG
TV15C401J(B)-G	447.0	494.0	1	1.0	400.0	2.30	648.0	GJK	BJK
TV15C441J(B)-G	492.0	543.0	1	1.0	440.0	2.10	713.0	GJM	BJM

Note:

- 1) Suffix J denotes 5% tolerance devices.
- 2) Suffix B after part number to specify Bi-directional devices.
- 3) For Bi-Directional devices having V<sub>R</sub> of 10 volts and under, the I<sub>R</sub> limit is double.

## Reel Taping Specification

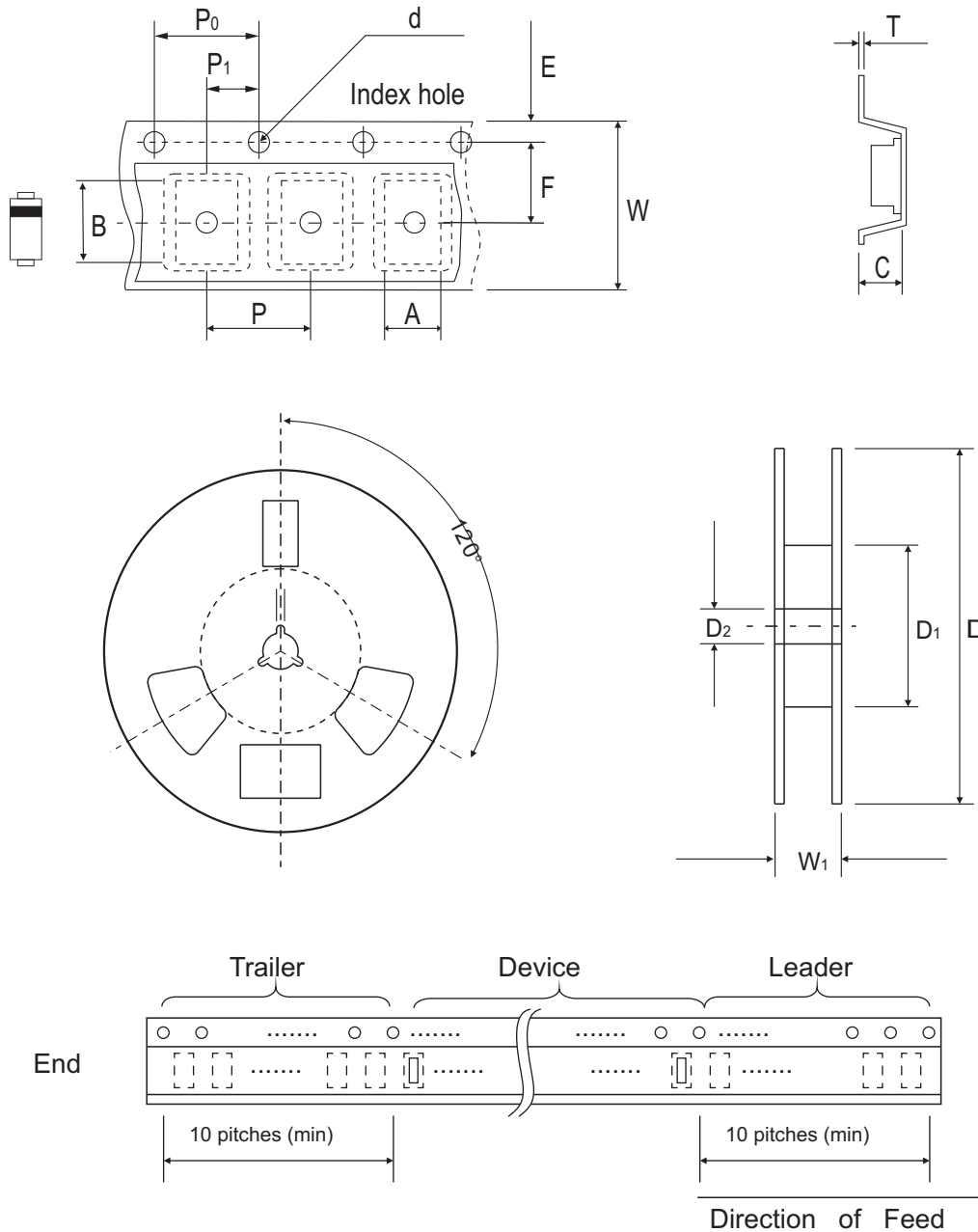

DO-214AB (SMC)	SYMBOL	A	B	C	d	D	D1	D2
	(mm)	6.05 ± 0.10	8.31 ± 0.10	3.29 (max)	1.55 ± 0.10	330.00	50.00 (min)	13.00 ± 0.20
	(inch)	0.238 ± 0.004	0.327 ± 0.004	0.130 (max)	0.061 ± 0.004	13.000	1.969 (min)	0.512 ± 0.008

DO-214AB (SMC)	SYMBOL	E	F	P	P0	P1	W	W1
	(mm)	1.75 ± 0.10	7.50 ± 0.10	8.00 ± 0.10	4.00 ± 0.10	2.00 ± 0.10	16.00 ± 0.30	22.40 (max)
	(inch)	0.069 ± 0.004	0.295 ± 0.004	0.315 ± 0.004	0.157 ± 0.004	0.079 ± 0.004	0.630 ± 0.012	0.882 (max)

Company reserves the right to improve product design, functions and reliability without notice.

REV:F