

TV30C5V0-G Thru. TV30C441-G

Working Peak Reverse Voltage: 5.0 to 440 Volts

Power Dissipation: 3000 Watts

RoHS Device

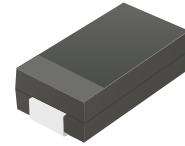

Features

- Glass passivated chip.
- 3000W peak pulse power capability with a 10/1000µs waveform, repetitive rate (duty cycle):0.01%
- Low leakage.
- Uni and Bidirectional unit.
- Excellent clamping capability.
- Very fast response time.
- UL recognized file # E349157  Range: TV30C5V0J(B) thru. TV30C171J(B)

Mechanical Data

- Case: DO-214AB/SMC molded plastic.
- Epoxy: UL 94V-0 rate flame retardant
- Terminals: Solderable per MIL-STD-750, method 2026.
- Polarity: Color band denoted cathode end except bipolar.
- Weight: 0.230 gram (approx.)

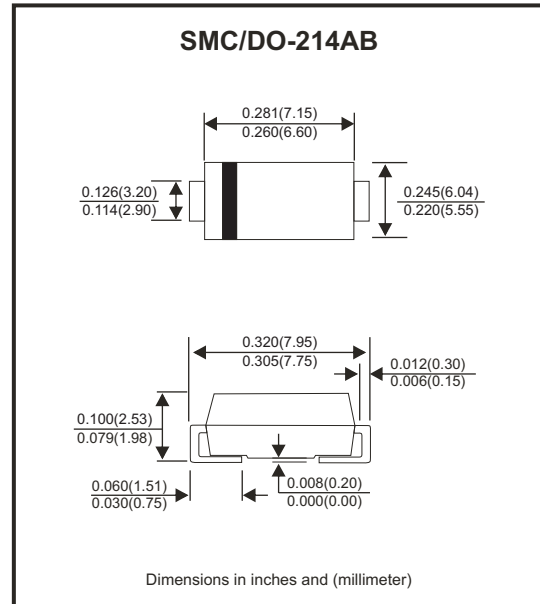

Circuit Diagram

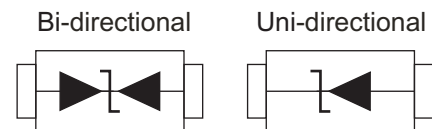

Maximum Ratings and Electrical Characteristics

Rating at 25°C ambient temperature unless otherwise specified.
Single phase, half wave, 60Hz, resistive or inductive load.
For capacitive load, derate current by 20%.

Characteristics	Symbol	Value	Units
Peak power dissipation with a 10/1000µs waveform (Note 1)	P _{PP}	3000	W
Peak pulse current with a 10/1000µs waveform (Note 1)	I _{PP}	See Next Table	A
Power dissipation on infinite heatsink at T _L =75°C	P _D	6.0	W
Peak forward surge current, 8.3ms single half sine-wave unidirectional only (Note 2)	I _{FSM}	300	A
Maximum instantaneous forward voltage at 100A for unidirectional only (Note 3)	V _F	3.5/5.0	V
Operation junction and storage temperature range	T _J , T _{STG}	-55 to +150	°C

- Notes: 1. Non-repetitive current pulse, per Fig.5 and derated above T_A=25°C, per Fig.1
2. Measured on 8.3 ms single half sine-wave or equivalent square wave, duty cycle = 4 pulses per minute maximum.
3. V_F<3.5V for devices of V_{BR}<200V and V_F<5.0V for devices of V_{BR}>201V

RATING AND CHARACTERISTIC CURVES (TV30C5V0-G Thru. TV30C441-G)

Fig.1 - Pulse Derating Curve

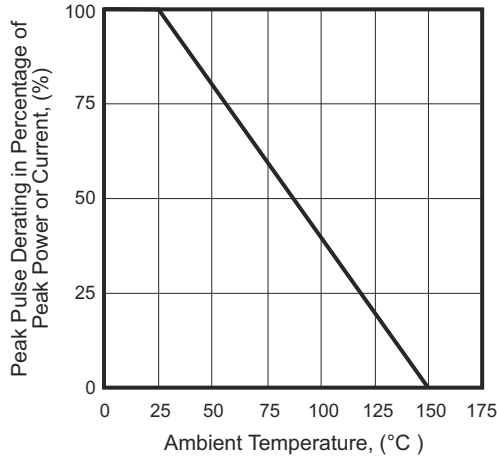

Fig.2 - Max. Non-Repetitive Surge Current

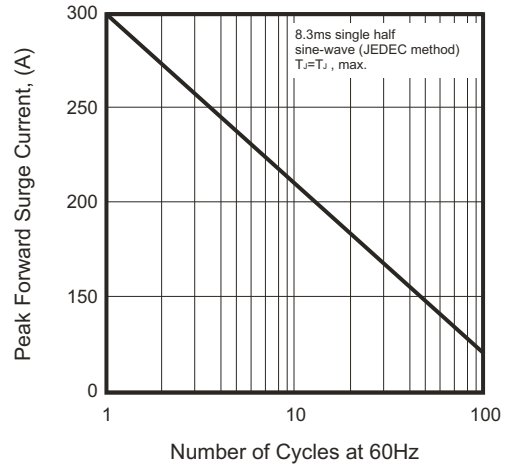

Fig.3 - Steady State Power Derating Curve



Fig.4 - Peak Pulse Power Rating Curve

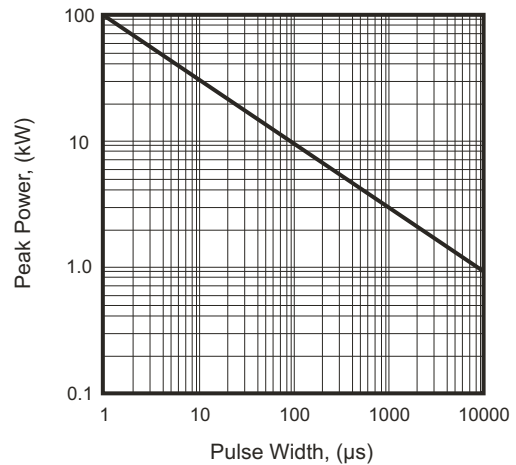

Fig.5 - Pulse Waveform

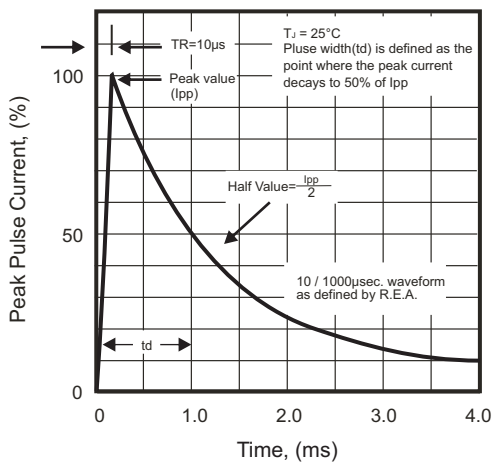
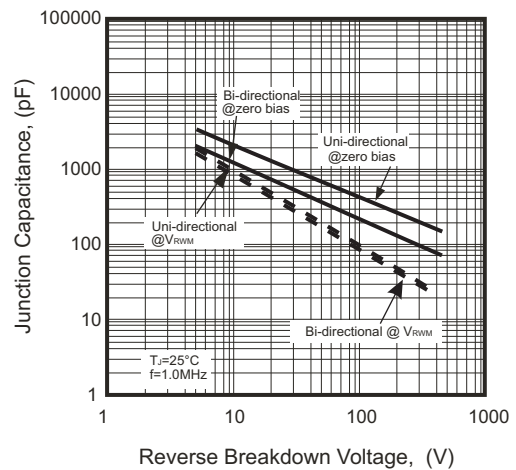

Fig.6 - Typical Junction Capacitance



SMD Transient Voltage Suppressor

Electrical Characteristics (TV30C5V0-G Thru. TV30C441-G)

Part No.	Breakdown voltage V _{BR} @ I _T			Maximum Reverse Leakage @VRWM I _R (uA)	Working Peak Reverse Voltage V _{VRWM} (V)	Maximum Reverse Surge Current I _{PP} (A)	Maximum Clamping Voltage @I _{PP} V _C (V)	Device Marking Code	
	Min. (V)	Max. (V)	I _T (mA)					UNI	BI
TV30C5V0J(B)-G	6.40	7.00	50	800	5.0	326.09	9.2	RDE	DDE
TV30C6V0J(B)-G	6.67	7.37	50	800	6.0	291.26	10.3	RDG	DDG
TV30C6V5J(B)-G	7.22	7.98	50	500	6.5	267.86	11.2	RDK	DDK
TV30C7V0J(B)-G	7.78	8.60	50	200	7.0	250.00	12.0	PDM	DDM
TV30C7V5J(B)-G	8.33	9.21	5	100	7.5	232.56	12.9	PDP	DDP
TV30C8V0J(B)-G	8.89	9.83	5	50	8.0	220.59	13.6	PDR	DDR
TV30C8V5J(B)-G	9.44	10.40	5	20	8.5	208.33	14.4	PDT	DDT
TV30C9V0J(B)-G	10.00	11.10	5	10	9.0	194.81	15.4	PDV	DDV
TV30C100J(B)-G	11.10	12.30	5	5	10.0	176.47	17.0	PDX	DDX
TV30C110J(B)-G	12.20	13.50	5	2	11.0	164.84	18.2	PDZ	DDZ
TV30C120J(B)-G	13.30	14.70	5	2	12.0	150.75	19.9	PEE	DEE
TV30C130J(B)-G	14.40	15.90	5	2	13.0	139.53	21.5	PEG	DEG
TV30C140J(B)-G	15.60	17.20	5	2	14.0	129.31	23.2	PEK	DEK
TV30C150J(B)-G	16.70	18.50	5	2	15.0	122.95	24.4	PEM	DEM
TV30C160J(B)-G	17.80	19.70	5	2	16.0	115.38	26.0	PEP	DEP
TV30C170J(B)-G	18.90	20.90	5	2	17.0	108.70	27.6	PER	DER
TV30C180J(B)-G	20.00	22.10	5	2	18.0	102.74	29.2	PET	DET
TV30C190J(B)-G	21.10	23.30	5	2	19.0	97.47	30.8	PEB	DEB
TV30C200J(B)-G	22.20	24.50	5	2	20.0	92.59	32.4	PEV	DEV
TV30C220J(B)-G	24.40	26.90	5	2	22.0	84.51	35.5	PEX	DEX
TV30C240J(B)-G	26.70	29.50	5	2	24.0	77.12	38.9	PEZ	DEZ
TV30C260J(B)-G	28.90	31.90	5	2	26.0	71.26	42.1	PFE	DFE
TV30C280J(B)-G	31.10	34.40	5	2	28.0	66.08	45.4	PFG	DFG
TV30C300J(B)-G	33.30	36.80	5	2	30.0	61.98	48.4	PFK	DFK
TV30C330J(B)-G	36.70	40.60	5	2	33.0	56.29	53.3	PFM	DFM
TV30C360J(B)-G	40.00	44.20	5	2	36.0	51.64	58.1	PFP	DFP
TV30C400J(B)-G	44.40	49.10	5	2	40.0	46.51	64.5	PFR	DFR
TV30C430J(B)-G	47.80	52.80	5	2	43.0	43.23	69.4	PFT	DFT
TV30C450J(B)-G	50.00	55.30	5	2	45.0	41.27	72.7	PFV	DFV
TV30C480J(B)-G	53.30	58.90	5	2	48.0	38.76	77.4	PFX	DFX
TV30C510J(B)-G	56.70	62.70	5	2	51.0	36.41	82.4	PFZ	DFZ
TV30C540J(B)-G	60.00	66.30	5	2	54.0	34.44	87.1	RGE	DGE
TV30C580J(B)-G	64.40	71.20	5	2	58.0	32.05	93.6	PGG	DGG
TV30C600J(B)-G	66.70	73.70	5	2	60.0	30.99	96.8	PGK	DGK
TV30C640J(B)-G	71.10	78.60	5	2	64.0	29.13	103.0	PGM	DGM
TV30C700J(B)-G	77.80	86.00	5	2	70.0	26.55	113.0	PGP	DGP
TV30C750J(B)-G	83.30	92.10	5	2	75.0	24.79	121.0	PGR	DGR
TV30C780J(B)-G	86.70	95.80	5	2	78.0	23.81	126.0	PGT	DGT
TV30C800J(B)-G	88.80	97.60	5	2	80.0	23.15	129.6	PGB	DGB
TV30C850J(B)-G	94.40	104.00	5	2	85.0	21.90	137.0	PGV	DGV
TV30C900J(B)-G	100.00	111.00	5	2	90.0	20.55	146.0	PGX	DGX
TV30C101J(B)-G	111.00	123.00	5	2	100.0	18.52	162.0	PGZ	DGZ
TV30C111J(B)-G	122.00	135.00	5	2	110.0	16.95	177.0	PHE	DHE
TV30C121J(B)-G	133.00	147.00	5	2	120.0	15.54	193.0	PHG	DHG

Company reserves the right to improve product design , functions and reliability without notice.

REV.1

SMD Transient Voltage Suppressor

Electrical Characteristics (TV30C5V0-G Thru. TV30C441-G)

Part No.	Breakdown voltage V _{BR} @ I _T			Maximum Reverse Leakage @V _{RWM} I _R (uA)	Working Peak Reverse Voltage V _{RWM} (V)	Maximum Reverse Surge Current I _{PP} (A)	Maximum Clamping Voltage @I _{PP} V _C (V)	Device Marking Code	
	Min. (V)	Max. (V)	I _T (mA)					UNI	BI
TV30C131J(B)-G	144.0	159.0	5	2	130.0	14.35	209.0	PHK	DHK
TV30C141J(B)-G	155.0	171.0	5	2	140.0	13.23	226.8	PHB	DHB
TV30C151J(B)-G	167.0	185.0	5	2	150.0	12.35	243.0	PHM	DHM
TV30C161J(B)-G	178.0	197.0	5	2	160.0	11.58	259.0	PHP	DHP
TV30C171J(B)-G	189.0	209.0	5	2	170.0	10.91	275.0	PHR	DHR
TV30C181J(B)-G	200.0	220.0	5	2	180.0	10.29	291.6	PHT	DHT
TV30C191J(B)-G	211.0	232.0	5	2	190.0	9.75	307.8	PHV	DHV
TV30C201J(B)-G	224.0	247.0	5	2	200.0	9.26	324.0	PHW	DHW
TV30C221J(B)-G	246.0	272.0	5	2	220.0	8.43	356.0	PHX	DHX
TV30C251J(B)-G	279.0	309.0	5	2	250.0	7.41	405.0	PHZ	DHZ
TV30C301J(B)-G	335.0	371.0	5	2	300.0	6.17	486.0	PJE	DJE
TV30C351J(B)-G	391.0	432.0	5	2	350.0	5.29	567.0	PJG	DJG
TV30C401J(B)-G	447.0	494.0	5	2	400.0	4.63	648.0	PJK	DJK
TV30C441J(B)-G	492.0	543.0	5	2	440.0	4.21	713.0	PJM	DJM

Note:

- 1) Suffix J denotes 5% tolerance devices.
- 2) Suffix B after part number to specify Bi-directional devices.
- 3) For Bi-Directional devices having V_R of 10 volts and under, the I_R limit is double.

Reel Taping Specification

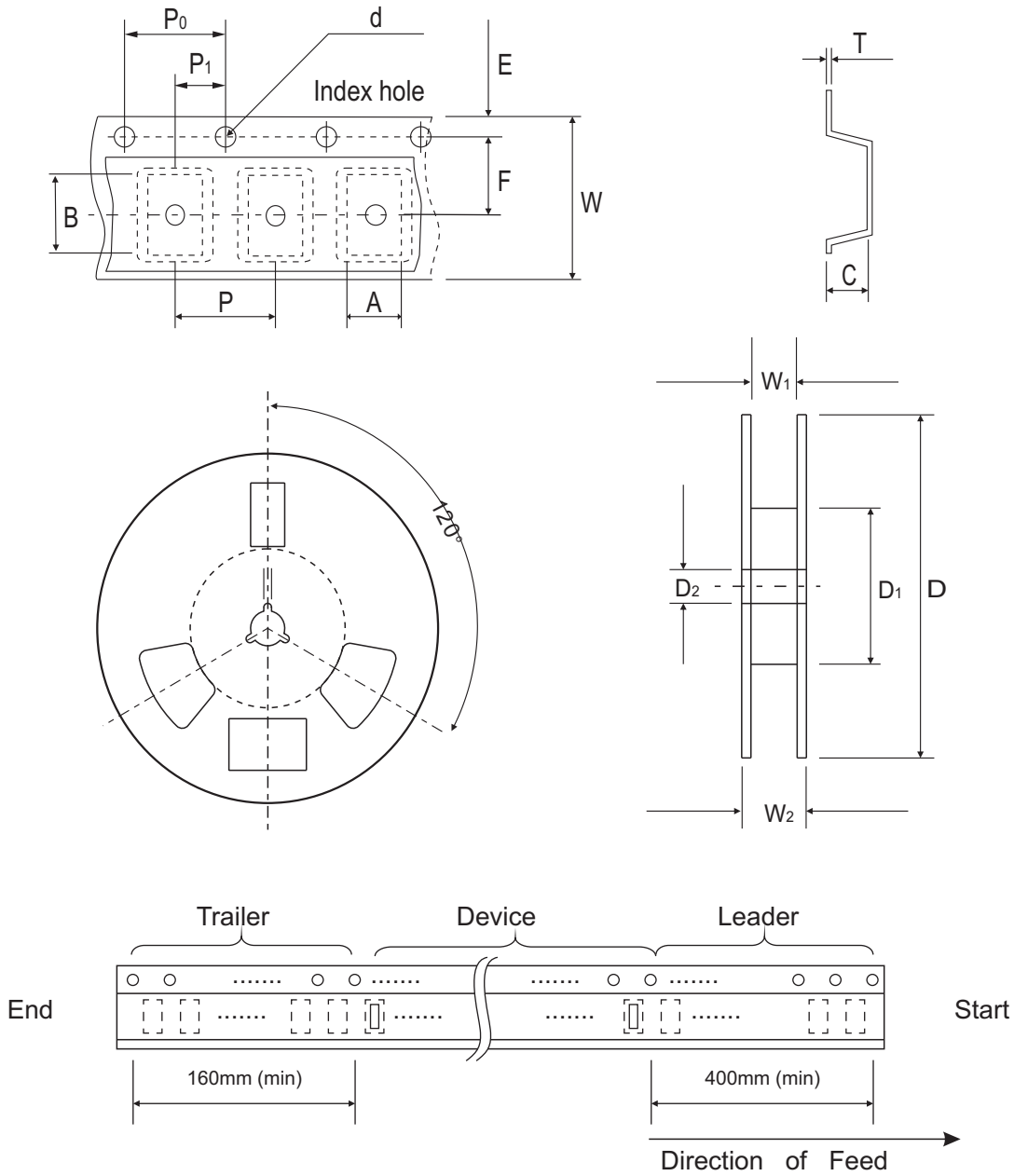

DO-214AB (SMC)	SYMBOL	A	B	C	d	T	D	D ₁	D ₂
	(mm)	See Note 1			1.55 ± 0.05	0.40 (Max.)	330.00	50.00 (Min.)	13.00 ^{+0.50} _{-0.20}
	(inch)	See Note 1			0.061 ± 0.002	0.016 (Max.)	13.000	1.969 (Min.)	0.512 ^{+0.020} _{-0.008}

DO-214AB (SMC)	SYMBOL	E	F	P	P ₀	P ₁	W	W ₁	W ₂
	(mm)	1.75 ± 0.10	7.50 ± 0.05	8.00 ± 0.10	4.00 ± 0.10	2.00 ± 0.05	16.00 ± 0.10	16.40 ^{+2.00} _{-0.00}	22.40 (Max.)
	(inch)	0.069 ± 0.004	0.295 ± 0.002	0.315 ± 0.004	0.157 ± 0.004	0.079 ± 0.002	0.630 ± 0.004	0.646 ^{+0.079} _{-0.000}	0.882 (Max.)

Notes: 1. A, B, and C the clearance between the component and the cavity must be within 0.5 mm max. for 8 mm tape and 12 mm tape, 1.0 mm max. for 16mm tape and 24 mm tape.

Company reserves the right to improve product design , functions and reliability without notice.