

SMD Transient Voltage Suppressor



TV50C110-G Thru. TV50C441-G

Working Voltage: 11 to 440 Volts

Peak Pulse Power: 5000 Watts

RoHS Device



Features

- Glass passivated chip.
- 5000W peak pulse power capability with a 10/1000µs waveform, repetitive rate (duty cycle):0.01%
- Low leakage.
- Uni and Bidirectional unit.
- Excellent clamping capability.
- Very fast response time.
- UL recognized file # E349157 

Mechanical Data

- Case: DO-214AB/SMC molded plastic.
- Epoxy: UL 94V-0 rate flame retardant
- Lead: Solderable per MIL-STD-750, method 2026.
- Polarity: Color band denoted cathode end except bipolar.
- Mounting position: Any
- Weight: 0.230 gram (approx.)



Circuit Diagram

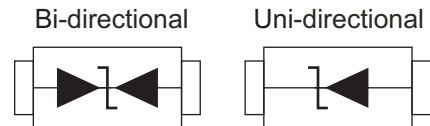

Maximum Ratings and Electrical Characteristics

Rating at 25°C ambient temperature unless otherwise specified.
 Single phase, half wave, 60Hz, resistive or inductive load.
 For capacitive load, derate current by 20%.

Parameter	Symbol	Value	Units
Peak power dissipation with a 10/1000µs waveform (Note 1)	P _{PP}	5000	W
Peak pulse current with a 10/1000µs waveform (Note 1)	I _{PP}	See Next Table	A
Power dissipation on infinite heatsink at T _L =75°C	P _D	6.5	W
Peak forward surge current, 8.3ms single half sine-wave unidirectional only (Note 2)	I _{FSM}	300	A
Maximum instantaneous forward voltage at 100A for unidirectional only (Note 3)	V _F	3.5/5.0	V
Operation junction and storage temperature range	T _J , T _{STG}	-55 to +150	°C

Notes: 1. Non-repetitive current pulse, per Fig.5 and derated above T_A=25°C, per Fig.1
 2. Measured on 8.3 ms single half sine-wave or equivalent square wave, duty cycle = 4 pulses per minute maximum.
 3. V_F<3.5V for devices of V_{BR}<200V and V_F<5.0V for devices of V_{BR}>201V

Company reserves the right to improve product design , functions and reliability without notice.

REV: G

RATING AND CHARACTERISTIC CURVES (TV50C110-G thru. TV50C441-G)

Fig.1 - Pulse Derating Curve

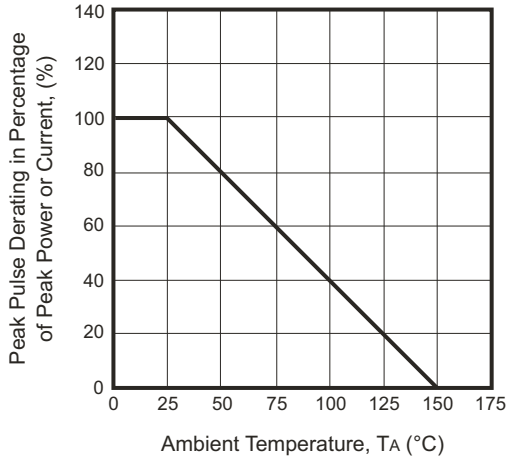

Fig.2 - Maximum Non-Repetitive Surge Current

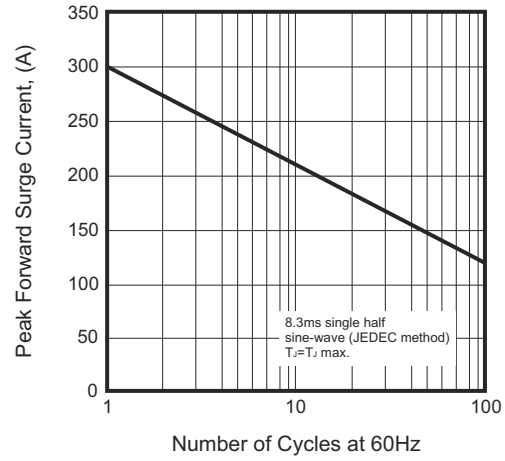

Fig.3 - Steady State Power Derating Curve

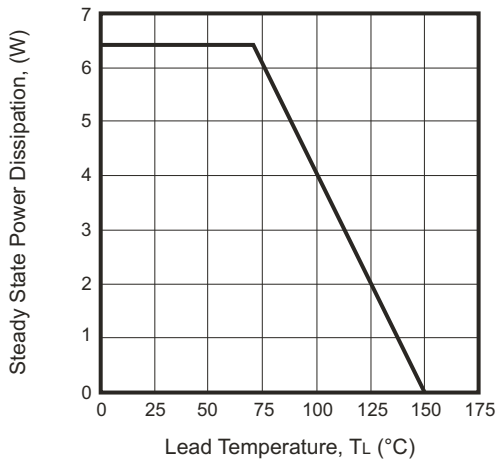

Fig.4 - Peak Pulse Power Rating Curve

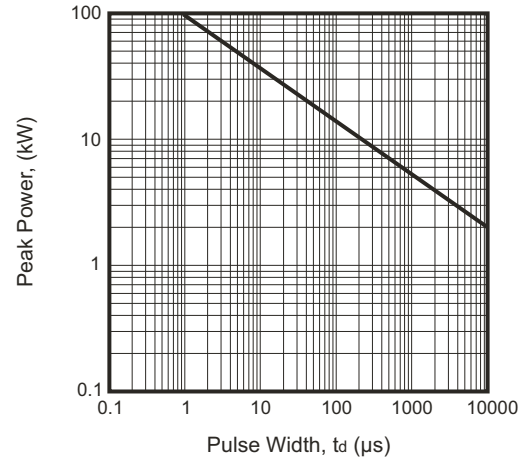

Fig.5 - Pulse Waveform

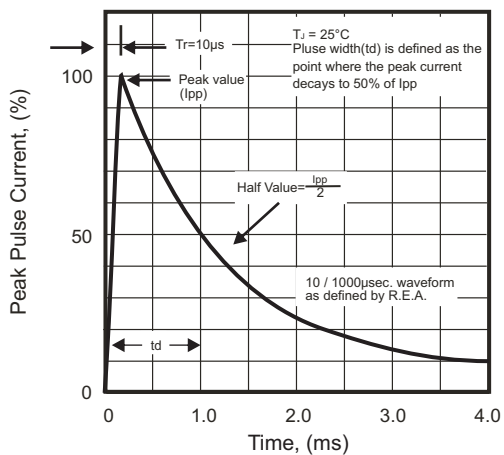
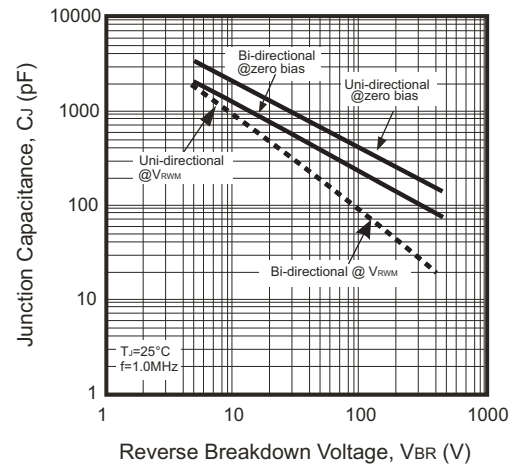

Fig.6 - Typical Junction Capacitance



SMD Transient Voltage Suppressor

Electrical Characteristics (TV50C110-G Thru. TV50C441-G)

Part No.	Breakdown voltage VBR @ IT			Maximum Reverse Leakage @VRWM IR (uA)	Working Peak Reverse Voltage VRWM (V)	Maximum Reverse Surge Current IPP (A)	Maximum Clamping Voltage @IPP Vc (V)	Device Marking Code	
	Min. (V)	Max. (V)	IT (mA)					UNI	BI
TV50C110J(B)-G	12.20	13.50	10	800	11.0	274.7	18.2	5PDX	5BDX
TV50C120J(B)-G	13.30	14.70	10	800	12.0	251.3	19.9	5PDZ	5BDZ
TV50C130J(B)-G	14.40	15.90	10	500	13.0	232.6	21.5	5PEE	5BEE
TV50C140J(B)-G	15.60	17.20	10	200	14.0	215.5	23.2	5PEG	5BEG
TV50C150J(B)-G	16.70	18.50	1	100	15.0	204.9	24.4	5PEK	5BEK
TV50C160J(B)-G	17.80	19.70	1	50	16.0	192.3	26.0	5PEM	5BEM
TV50C170J(B)-G	18.90	20.90	1	20	17.0	181.2	27.6	5PEP	5BEP
TV50C180J(B)-G	20.00	22.10	1	10	18.0	171.2	29.2	5PER	5BER
TV50C190J(B)-G	21.10	23.30	1	10	19.0	162.4	30.8	5PET	5BET
TV50C200J(B)-G	22.20	24.50	1	5	20.0	154.3	32.4	5PEV	5BEV
TV50C220J(B)-G	24.40	26.90	1	5	22.0	140.8	35.5	5PEX	5BEX
TV50C240J(B)-G	26.70	29.50	1	5	24.0	128.5	38.9	5PEZ	5BEZ
TV50C260J(B)-G	28.90	31.90	1	5	26.0	118.8	42.1	5PFE	5BFE
TV50C280J(B)-G	31.10	34.40	1	5	28.0	110.1	45.4	5PFG	5BFG
TV50C300J(B)-G	33.30	36.80	1	5	30.0	103.3	48.4	5PFK	5BFK
TV50C330J(B)-G	36.70	40.60	1	5	33.0	93.8	53.3	5PFM	5BFM
TV50C360J(B)-G	40.00	44.20	1	5	36.0	86.1	58.1	5PFP	5BFP
TV50C400J(B)-G	44.40	49.10	1	5	40.0	77.5	64.5	5PFR	5BFR
TV50C430J(B)-G	47.80	52.80	1	5	43.0	72.0	69.4	5PFT	5BFT
TV50C450J(B)-G	50.00	55.30	1	5	45.0	68.8	72.7	5PFV	5BFV
TV50C480J(B)-G	53.30	58.90	1	5	48.0	64.6	77.4	5PFX	5BFX
TV50C510J(B)-G	56.70	62.70	1	5	51.0	60.7	82.4	5PFZ	5BFZ
TV50C540J(B)-G	60.00	66.30	1	5	54.0	57.4	87.1	5PGE	5BGE
TV50C580J(B)-G	64.40	71.20	1	5	58.0	53.4	93.6	5PGG	5BGG
TV50C600J(B)-G	66.70	73.70	1	5	60.0	51.7	96.8	5PGK	5BGK
TV50C640J(B)-G	71.10	78.60	1	5	64.0	48.5	103.0	5PGM	5BGM
TV50C700J(B)-G	77.80	86.00	1	5	70.0	44.2	113.0	5PGP	5BGP
TV50C750J(B)-G	83.30	92.10	1	5	75.0	41.3	121.0	5PGR	5BGR
TV50C780J(B)-G	86.70	95.80	1	5	78.0	39.7	126.0	5PGT	5BGT
TV50C800J(B)-G	88.80	97.60	1	5	80.0	38.6	129.6	5PGB	5BGB
TV50C850J(B)-G	94.40	104.0	1	5	85.0	36.5	137.0	5PGV	5BGV
TV50C900J(B)-G	100.0	111.0	1	5	90.0	34.2	146.0	5PGX	5BGX
TV50C101J(B)-G	111.0	123.0	1	5	100.0	30.9	162.0	5PGZ	5BGZ
TV50C111J(B)-G	122.0	135.0	1	5	110.0	28.2	177.0	5PHE	5BHE
TV50C121J(B)-G	133.0	147.0	1	5	120.0	25.9	193.0	5PHG	5BHG
TV50C131J(B)-G	144.0	159.0	1	5	130.0	23.9	209.0	5PHK	5BHK
TV50C141J(B)-G	155.0	171.0	1	5	140.0	22.0	226.8	5PHB	5BHB
TV50C151J(B)-G	167.0	185.0	1	5	150.0	20.6	243.0	5PHM	5BHM
TV50C161J(B)-G	178.0	197.0	1	5	160.0	19.3	259.0	5PHP	5BHP
TV50C171J(B)-G	189.0	209.0	1	5	170.0	18.2	275.0	5PHR	5BHR

Company reserves the right to improve product design , functions and reliability without notice.

REV: G

SMD Transient Voltage Suppressor

Electrical Characteristics (TV50C110-G Thru. TV50C441-G)

Part No.	Breakdown voltage VBR @ IT			Maximum Reverse Leakage @VRWM IR (uA)	Working Peak Reverse Voltage VRWM (V)	Maximum Reverse Surge Current IPP (A)	Maximum Clamping Voltage @IPP Vc (V)	Device Marking Code	
	Min. (V)	Max. (V)	IT (mA)					UNI	BI
TV50C181J(B)-G	200.0	220.0	1	5	180.0	17.1	291.6	5PHT	5BHT
TV50C191J(B)-G	211.0	232.0	1	5	190.0	16.2	307.8	5PHV	5BHV
TV50C201J(B)-G	224.0	247.0	1	5	200.0	15.4	324.0	5PHW	5BHW
TV50C221J(B)-G	246.0	272.0	1	5	220.0	14.0	356.0	5PHX	5BHX
TV50C251J(B)-G	279.0	309.0	1	5	250.0	12.3	405.0	5PHZ	5BHZ
TV50C301J(B)-G	335.0	371.0	1	5	300.0	10.3	486.0	5PJE	5BJE
TV50C351J(B)-G	391.0	432.0	1	5	350.0	8.8	567.0	5PJG	5BJG
TV50C401J(B)-G	447.0	494.0	1	5	400.0	7.7	648.0	5PJK	5BJK
TV50C441J(B)-G	492.0	543.0	1	5	440.0	7.0	713.0	5PJM	5BJM

Note:

- 1) Suffix J denotes 5% tolerance devices.
- 2) Suffix B after part number to specify bi-directional devices.
- 3) For Bi-Directional devices having VR of 20 volts and under, the IR limit is double.

Reel Taping Specification

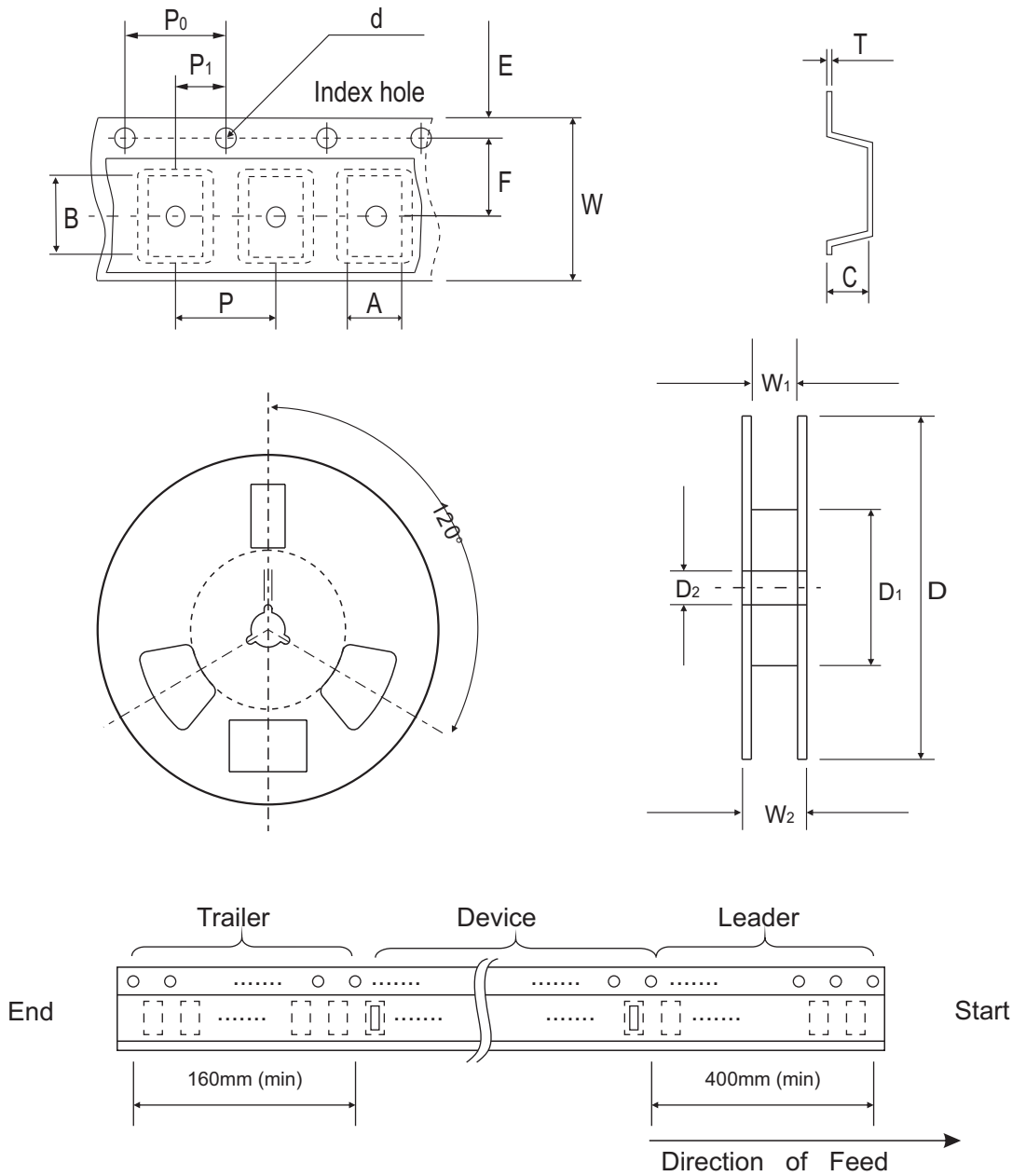

DO-214AB (SMC)	SYMBOL	A	B	C	d	T	D	D ₁	D ₂
	(mm)	See Note 1			1.55 ± 0.05	0.40 (Max.)	330.00	50.00 (Min.)	13.00 ^{+0.50} _{-0.20}
	(inch)	See Note 1			0.061 ± 0.002	0.016 (Max.)	13.000	1.969 (Min.)	0.512 ^{+0.020} _{-0.008}

DO-214AB (SMC)	SYMBOL	E	F	P	P ₀	P ₁	W	W ₁	W ₂
	(mm)	1.75 ± 0.10	7.50 ± 0.05	8.00 ± 0.10	4.00 ± 0.10	2.00 ± 0.05	16.00 ± 0.10	16.40 ^{+2.00} _{-0.00}	22.40 (Max.)
	(inch)	0.069 ± 0.004	0.295 ± 0.002	0.315 ± 0.004	0.157 ± 0.004	0.079 ± 0.002	0.630 ± 0.004	0.646 ^{+0.079} _{-0.000}	0.882 (Max.)

Notes: 1. A, B, and C the clearance between the component and the cavity must be within 0.5 mm max. for 8 mm tape and 12 mm tape, 1.0 mm max. for 16mm tape and 24 mm tape.

Company reserves the right to improve product design , functions and reliability without notice.

REV: G