

## U304, U305, U306 P-Channel JFET

### Features

- InterFET [P0099F Geometry](#)
- Typical Noise: 8 nV/VHz
- Fast Switching
- RoHS Compliant
- SMT, TH, and Bare Die Package options.

### Applications

- Analog Switch
- Chopper

### Description

The 30V InterFET U304, U305, and U306 JFET's are targeted for choppers and switching designs. The on resistance is typically less than 100 Ohms at room temperatures. The TO-72 package is hermetically sealed and suitable for military applications.

TO-18 Bottom View

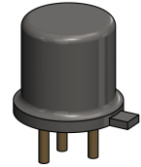
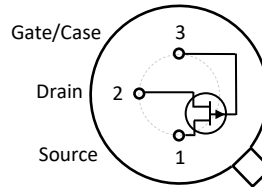

SOT23 Top View

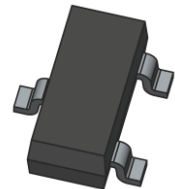
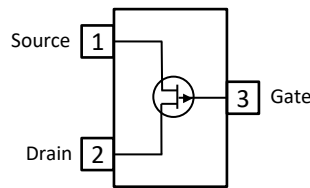

TO-92 Bottom View

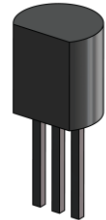
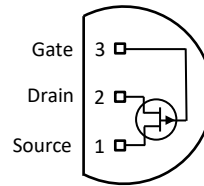

### Product Summary

Parameters	U304 Min	U305 Min	U306 Min	Unit
$BV_{GSS}$ Gate to Source Breakdown Voltage	30	30	30	V
$I_{DSS}$ Drain to Source Saturation Current	-30	-15	-5	mA
$V_{GS(off)}$ Gate to Source Cutoff Voltage	5	3	1	V

### Ordering Information Custom Part and Binning Options Available

Part Number	Description	Case	Packaging
U304; U305; U306	Through-Hole	TO-18	Bulk
PNU304; PNU305; PNU306	Through-Hole	TO-92	Bulk
SMPU304; SMPU305; SMPU306	Surface Mount	SOT23	Bulk
SMPU304TR; SMPU305TR; SMPU306TR	7" Tape and Reel: Max 3,000 Pieces 13" Tape and Reel: Max 9,000 Pieces	SOT23	Minimum 1,000 Pieces Tape and Reel
U304COT; U305COT; U306COT	Chip Orientated Tray (COT Waffle Pack)	COT	400/Waffle Pack
U304CFT; U305CFT; U306CFT	Chip Face-up Tray (CFT Waffle Pack)	CFT	400/Waffle Pack



**Disclaimer:** It is the Buyers responsibility for designing, validating and testing the end application under all field use cases and extreme use conditions. Guaranteeing the application meets required standards, regulatory compliance, and all safety and security requirements is the responsibility of the Buyer. These resources are subject to change without notice.

## Electrical Characteristics

### Maximum Ratings (@ $T_A = 25^\circ\text{C}$ , Unless otherwise specified)

Parameters	Value	Unit
$V_{RGS}$ Reverse Gate Source and Gate Drain Voltage	30	V
$I_{FG}$ Continuous Forward Gate Current	-50	mA
$P_D$ Continuous Device Power Dissipation	350	mW
$P$ Power Derating	2.8	mW/ $^\circ\text{C}$
$T_J$ Operating Junction Temperature	-55 to 125	$^\circ\text{C}$
$T_{STG}$ Storage Temperature	-65 to 150	$^\circ\text{C}$

### Static Characteristics (@ $T_A = 25^\circ\text{C}$ , Unless otherwise specified)

Parameters	Conditions	U304		U305		U306		Unit
		Min	Max	Min	Max	Min	Max	
$V_{(BR)GSS}$ Gate to Source Breakdown Voltage	$V_{DS} = 0V, I_G = 1\mu\text{A}$	30		30		30		V
$I_{GSS}$ Gate to Source Reverse Current	$V_{GS} = 20V, V_{DS} = 0V, T_A = 25^\circ\text{C}$ $V_{GS} = 20V, V_{DS} = 0V, T_A = 125^\circ\text{C}$		500 1		500 1		500 1	pA $\mu\text{A}$
$V_{GS(OFF)}$ Gate to Source Cutoff Voltage	$V_{DS} = -15V, I_D = -1\mu\text{A}$	5	10	3	6	1	4	V
$I_{D(OFF)}$ Drain Cutoff Current	$V_{DG} = -15V, V_{GS} = ( ), T_A = 25^\circ\text{C}$ $V_{DG} = -15V, V_{GS} = ( ), T_A = 125^\circ\text{C}$		-500 -1 (12)		-500 -1 (7)		-500 -1 (3)	nA $\mu\text{A}$ V
$I_{DSS}$ Drain to Source Saturation Current	$V_{DS} = -15V, V_{GS} = 0V$ (Pulsed)	-30	-90	-15	-60	-5	-25	mA
$V_{DS(ON)}$ Drain to Source ON Voltage	$V_{GS} = 0V, I_D = ( )$		-1.3 (-15)		-0.8 (-7)		-0.6 (-5)	V mA

### Dynamic Characteristics (@ $T_A = 25^\circ\text{C}$ , Unless otherwise specified)

Parameters	Conditions	U304		U305		U306		Unit
		Min	Max	Min	Max	Min	Max	
$R_{DS(ON)}$ Drain to Source ON Resistance	$I_D = 0A, V_{GS} = 0V, f = 1\text{kHz}$		85		110		175	$\Omega$
$C_{iss}$ Input Capacitance	$V_{DS} = -15V, V_{GS} = 0V, f = 1\text{MHz}$		27		27		27	pF
$C_{rss}$ Reverse Transfer Capacitance	$V_{DS} = 0V, V_{GS} = ( ), f = 1\text{MHz}$		7 (12)		7 (7)		7 (5)	pF V
$t_{d(ON)}$ Turn ON Delay Time	$V_{GS(ON)} = 0V$ <b>U304:</b> $V_{DD} = -10V, V_{GS(OFF)} = 12V,$ $R_L = 580\Omega, I_{D(ON)} = -15\text{mA}$ <b>U305:</b> $V_{DD} = -6V, V_{GS(OFF)} = 7V,$ $R_L = 743\Omega, I_{D(ON)} = -7\text{mA}$ <b>U306:</b> $V_{DD} = -6V, V_{GS(OFF)} = 5V,$ $R_L = 1800\Omega, I_{D(ON)} = -3\text{mA}$		20		25		25	nS
$t_r$ Rise Time			15		25		35	nS
$t_f$ Fall Time			25		40		60	nS
$t_{d(OFF)}$ Turn OFF Delay Time			10		15		20	nS

## SOT23 (TO-236AB) Mechanical and Layout Data

### Package Outline Data



1. All linear dimensions are in millimeters.
2. Package weight approximately 0.12 grams
3. Molded plastic case UL 94V-0 rated
4. For Tape and Reel specifications refer to InterFET CTC-021 Tape and Reel Specification, Document number: IF39002
5. Bulk product is shipped in standard ESD shipping material
6. Refer to JEDEC standards for additional information.

### Suggested Pad Layout



1. All linear dimensions are in millimeters.
2. The suggested land pattern dimensions have been provided for reference only. A more robust pattern may be desired for wave soldering.

## TO-18 Mechanical and Layout Data

### Package Outline Data

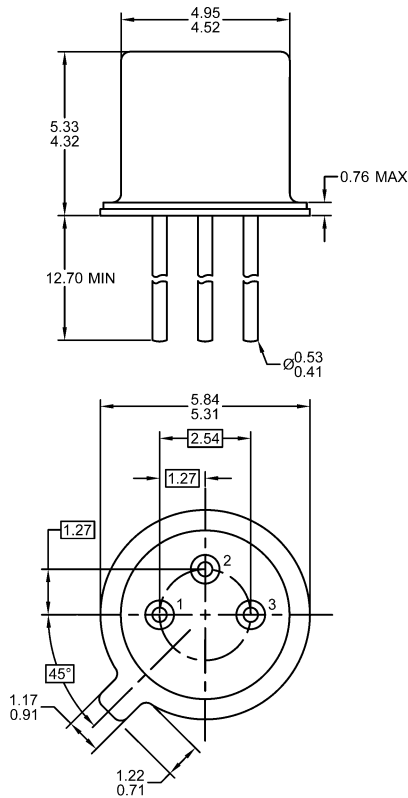

1. All linear dimensions are in millimeters.
2. Package weight approximately 0.29 grams
3. Bulk product is shipped in standard ESD shipping material
4. Refer to JEDEC standards for additional information.

### Suggested Through-Hole Layout

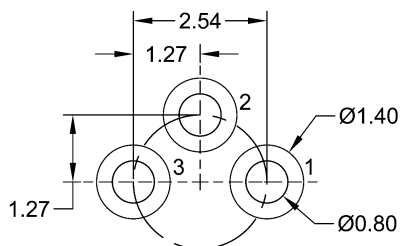

1. All linear dimensions are in millimeters.
2. The suggested land pattern dimensions have been provided as a straight lead reference only. A more robust pattern may be desired for wave soldering and/or bent lead configurations.