

# UAA2016

## Zero Voltage Switch Power Controller

The UAA2016 is designed to drive triacs with the Zero Voltage Switching technique which allows RFI-free power regulation of resistive loads. Operating directly on the AC power line, its main application is the precision regulation of electrical heating systems such as panel heaters or irons.

A built-in digital sawtooth waveform permits proportional temperature regulation action over a  $\pm 1^\circ\text{C}$  band around the set point. For energy savings there is a programmable temperature reduction function, and for security a sensor failsafe inhibits output pulses when the sensor connection is broken. Preset temperature (i.e. defrost) application is also possible. In applications where high hysteresis is needed, its value can be adjusted up to  $5^\circ\text{C}$  around the set point. All these features are implemented with a very low external component count.

### Features

- Zero Voltage Switch for Triacs, up to 2.0 kW (MAC212A8)
- Direct AC Line Operation
- Proportional Regulation of Temperature over a  $1^\circ\text{C}$  Band
- Programmable Temperature Reduction
- Preset Temperature (i.e. Defrost)
- Sensor Failsafe
- Adjustable Hysteresis
- Low External Component Count
- Pb-Free Packages are Available

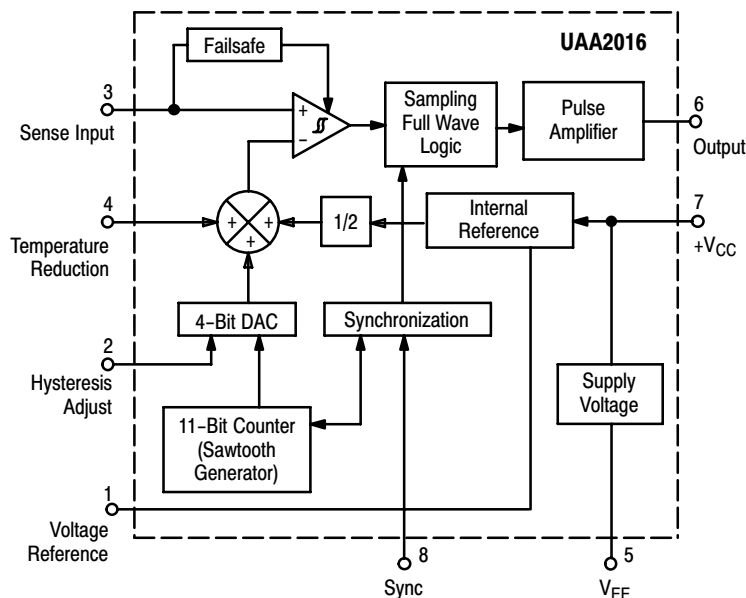

Figure 1. Representative Block Diagram



ON Semiconductor®

<http://onsemi.com>

## ZERO VOLTAGE SWITCH POWER CONTROLLER

### MARKING DIAGRAMS

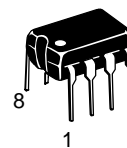

PDP-8  
P SUFFIX  
CASE 626

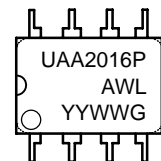

SOIC-8  
D SUFFIX  
CASE 751

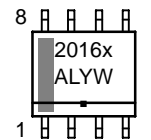

x = A or D  
A = Assembly Location  
WL, L = Wafer Lot  
YY, Y = Year  
WW, W = Work Week  
G, ■ = Pb-Free Package  
(Note: Microdot may be in either location)

### PIN CONNECTIONS

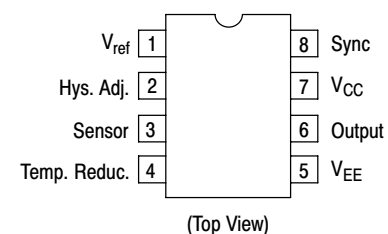

### ORDERING INFORMATION

See detailed ordering and shipping information in the package dimensions section on page 9 of this data sheet.

# UAA2016

## MAXIMUM RATINGS (Voltages referenced to Pin 7)

Rating	Symbol	Value	Unit
Supply Current ( $I_{Pin\ 5}$ )	$I_{CC}$	15	mA
Non-Repetitive Supply Current, (Pulse Width = 1.0 $\mu$ s)	$I_{CCP}$	200	mA
AC Synchronization Current	$I_{sync}$	3.0	mA
Pin Voltages	$V_{Pin\ 2}$ $V_{Pin\ 3}$ $V_{Pin\ 4}$ $V_{Pin\ 6}$	0; $V_{ref}$ 0; $V_{ref}$ 0; $V_{ref}$ 0; $V_{EE}$	V
$V_{ref}$ Current Sink	$I_{Pin\ 1}$	1.0	mA
Output Current (Pin 6), (Pulse Width < 400 $\mu$ s)	$I_O$	150	mA
Power Dissipation	$P_D$	625	mW
Thermal Resistance, Junction-to-Air	$R_{\theta JA}$	100	$^{\circ}C/W$
Operating Temperature Range	$T_A$	- 20 to + 85	$^{\circ}C$

Maximum ratings are those values beyond which device damage can occur. Maximum ratings applied to the device are individual stress limit values (not normal operating conditions) and are not valid simultaneously. If these limits are exceeded, device functional operation is not implied, damage may occur and reliability may be affected.

## ELECTRICAL CHARACTERISTICS ( $T_A = 25^{\circ}C$ , $V_{EE} = -7.0$ V, voltages referred to Pin 7, unless otherwise noted.)

Characteristic	Symbol	Min	Typ	Max	Unit
Supply Current (Pins 6, 8 not connected), ( $T_A = -20^{\circ}$ to $+85^{\circ}C$ )	$I_{CC}$	-	0.9	1.5	mA
Stabilized Supply Voltage (Pin 5), ( $I_{CC} = 2.0$ mA)	$V_{EE}$	-10	-9.0	-8.0	V
Reference Voltage (Pin 1)	$V_{ref}$	-6.5	-5.5	-4.5	V
Output Pulse Current ( $T_A = -20^{\circ}$ to $+85^{\circ}C$ ), ( $R_{out} = 60$ W, $V_{EE} = -8.0$ V)	$I_O$	90	100	130	mA
Output Leakage Current ( $V_{out} = 0$ V)	$I_{OL}$	-	-	10	$\mu$ A
Output Pulse Width ( $T_A = -20^{\circ}$ to $+85^{\circ}C$ ) (Note 1), (Mains = 220 Vrms, $R_{sync} = 220$ k $\Omega$ )	$T_P$	50	-	100	$\mu$ s
Comparator Offset (Note 5)	$V_{off}$	-10	-	+10	mV
Sensor Input Bias Current	$I_{IB}$	-	-	0.1	$\mu$ A
Sawtooth Period (Note 2)	$T_S$	-	40.96	-	sec
Sawtooth Amplitude (Note 6)	$A_S$	50	70	90	mV
Temperature Reduction Voltage (Note 3), (Pin 4 Connected to $V_{CC}$ )	$V_{TR}$	280	350	420	mV
Internal Hysteresis Voltage, (Pin 2 Not Connected)	$V_{IH}$	-	10	-	mV
Additional Hysteresis (Note 4), (Pin 2 Connected to $V_{CC}$ )	$V_H$	280	350	420	mV
Failsafe Threshold ( $T_A = -20^{\circ}$ to $+85^{\circ}C$ ) (Note 7)	$V_{FSth}$	180	-	300	mV

1. Output pulses are centered with respect to zero crossing point. Pulse width is adjusted by the value of  $R_{sync}$ . Refer to application curves.
2. The actual sawtooth period depends on the AC power line frequency. It is exactly 2048 times the corresponding period. For the 50 Hz case it is 40.96 sec. For the 60 Hz case it is 34.13 sec. This is to comply with the European standard, namely that 2.0 kW loads cannot be connected or removed from the line more than once every 30 sec. The inertia of most heating systems combined with the UAA2016 will comply with the European Standard.
3. 350 mV corresponds to  $5^{\circ}C$  temperature reduction. This is tested at probe using internal test pad. Smaller temperature reduction can be obtained by adding an external resistor between Pin 4 and  $V_{CC}$ . Refer to application curves.
4. 350 mV corresponds to a hysteresis of  $5^{\circ}C$ . This is tested at probe using internal test pad. Smaller additional hysteresis can be obtained by adding an external resistor between Pin 2 and  $V_{CC}$ . Refer to application curves.
5. Parameter guaranteed but not tested. Worst case 10 mV corresponds to  $0.15^{\circ}C$  shift on set point.
6. Measured at probe by internal test pad. 70 mV corresponds to  $1^{\circ}C$ . Note that the proportional band is independent of the NTC value.
7. At very low temperature the NTC resistor increases quickly. This can cause the sensor input voltage to reach the failsafe threshold, thus inhibiting output pulses; refer to application schematics. The corresponding temperature is the limit at which the circuit works in the typical application. By setting this threshold at  $0.05 V_{ref}$ , the NTC value can increase up to 20 times its nominal value, thus the application works below  $-20^{\circ}C$ .

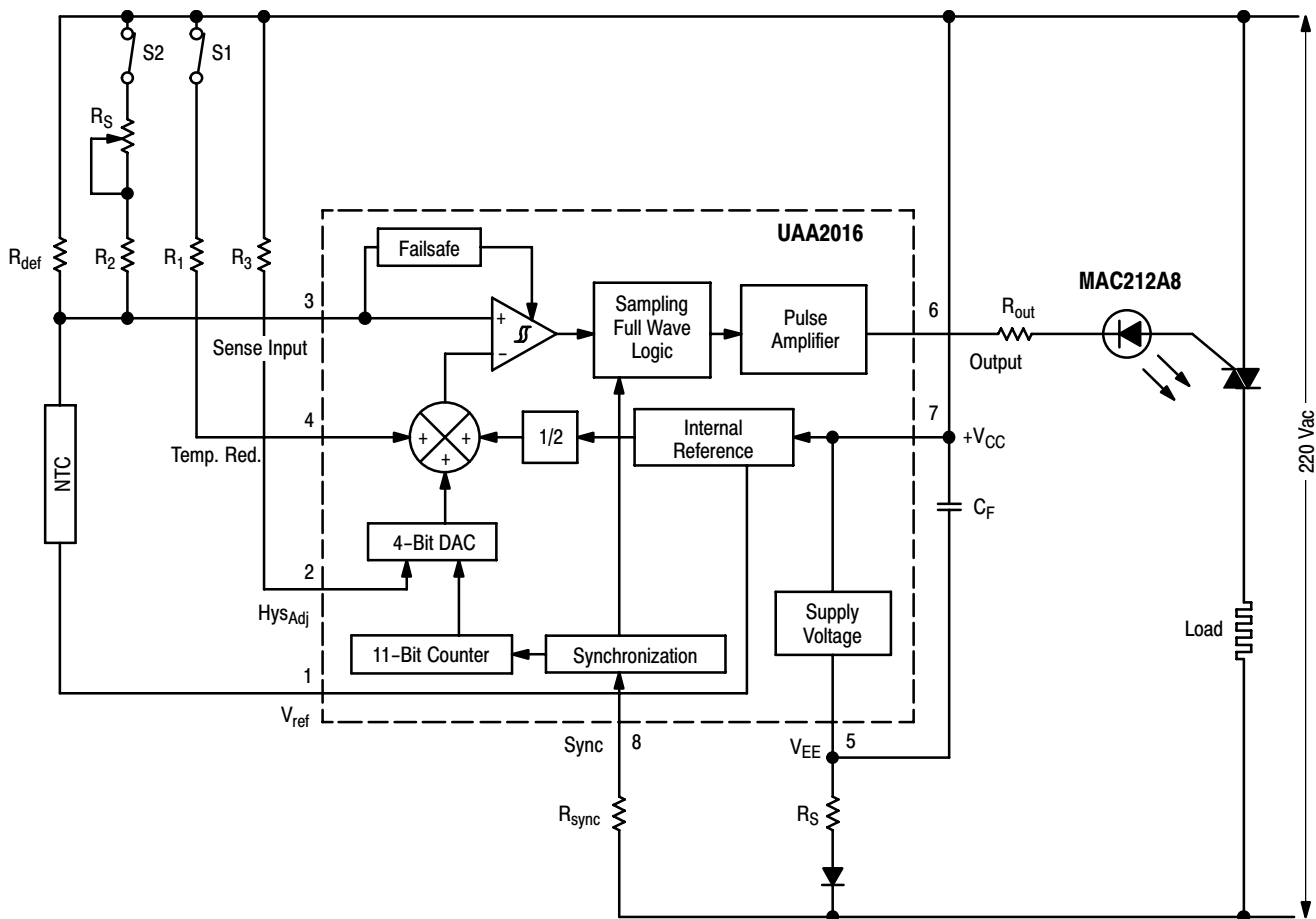

Figure 1. Application Schematic

**APPLICATION INFORMATION**

(For simplicity, the LED in series with  $R_{out}$  is omitted in the following calculations.)

**Triac Choice and  $R_{out}$  Determination**

Depending on the power in the load, choose the triac that has the lowest peak gate trigger current. This will limit the output current of the UAA2016 and thus its power consumption. Use Figure 4 to determine  $R_{out}$  according to the triac maximum gate current ( $I_{GT}$ ) and the application low temperature limit. For a 2.0 kW load at 220 Vrms, a good triac choice is the ON Semiconductor MAC212A8. Its maximum peak gate trigger current at 25°C is 50 mA.

For an application to work down to -20°C,  $R_{out}$  should be 60 Ω. It is assumed that:  $I_{GT}(T) = I_{GT}(25°C) \times \exp(-T/125)$  with T in °C, which applies to the MAC212A8.

**Output Pulse Width,  $R_{sync}$**

The pulse with  $T_P$  is determined by the triac's  $I_{Hold}$ ,  $I_{Latch}$  together with the load value and working conditions (frequency and voltage):

Given the RMS AC voltage and the load power, the load value is:

$$R_L = V^2_{rms}/POWER$$

The load current is then:

$$I_{Load} = (V_{rms} \times \sqrt{2} \times \sin(2\pi ft) - V_{TM})/R_L$$

where  $V_{TM}$  is the maximum on state voltage of the triac, f is the line frequency.

Set  $I_{Load} = I_{Latch}$  for  $t = T_P/2$  to calculate  $T_P$ .

Figures 6 and 7 give the value of  $T_P$  which corresponds to the higher of the values of  $I_{Hold}$  and  $I_{Latch}$ , assuming that  $V_{TM} = 1.6$  V. Figure 8 gives the  $R_{sync}$  that produces the corresponding  $T_P$ .

**$R_{supply}$  and Filter Capacitor**

With the output current and the pulse width determined as above, use Figures 9 and 10 to determine  $R_{Supply}$ , assuming that the sinking current at  $V_{ref}$  pin (including NTC bridge current) is less than 0.5 mA. Then use Figure 11 and 12 to determine the filter capacitor ( $C_F$ ) according to the ripple desired on supply voltage. The maximum ripple allowed is 1.0 V.

**Temperature Reduction Determined by  $R_1$**

(Refer to Figures 13 and 14.)

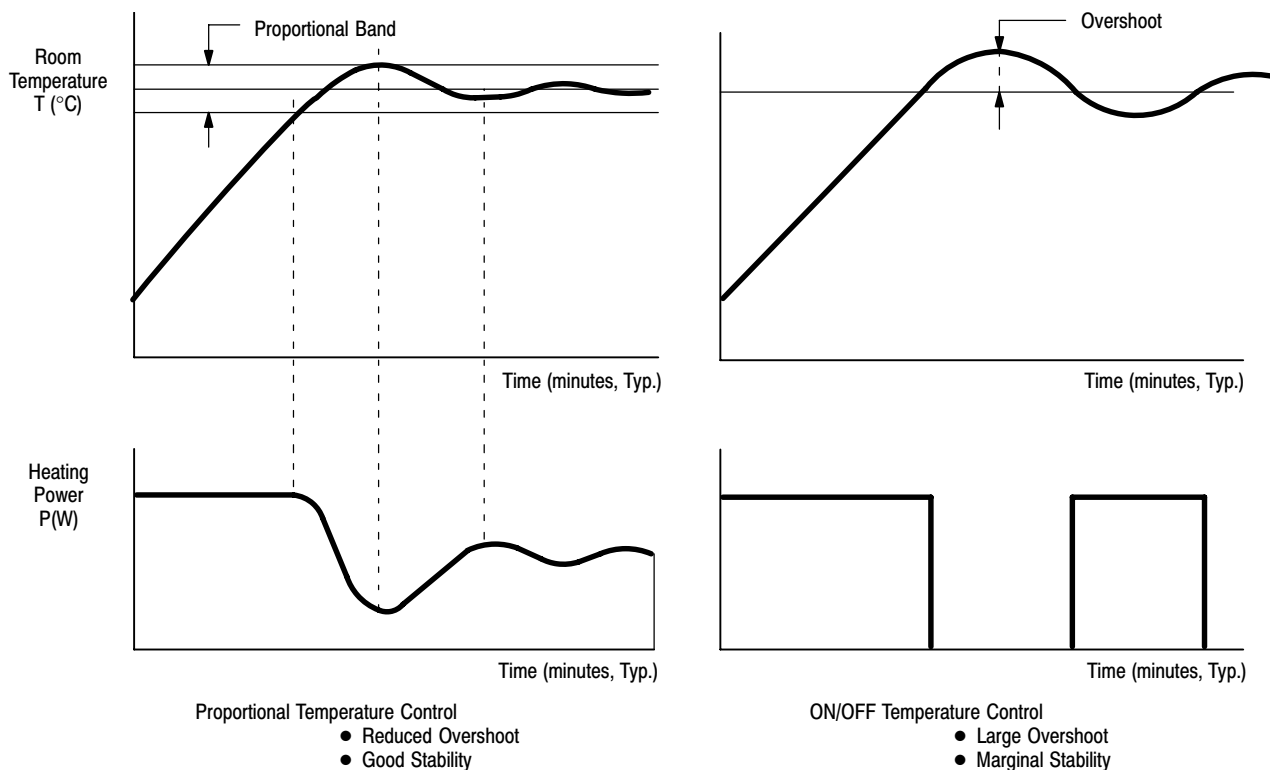

Figure 2. Comparison Between Proportional Control and ON/OFF Control

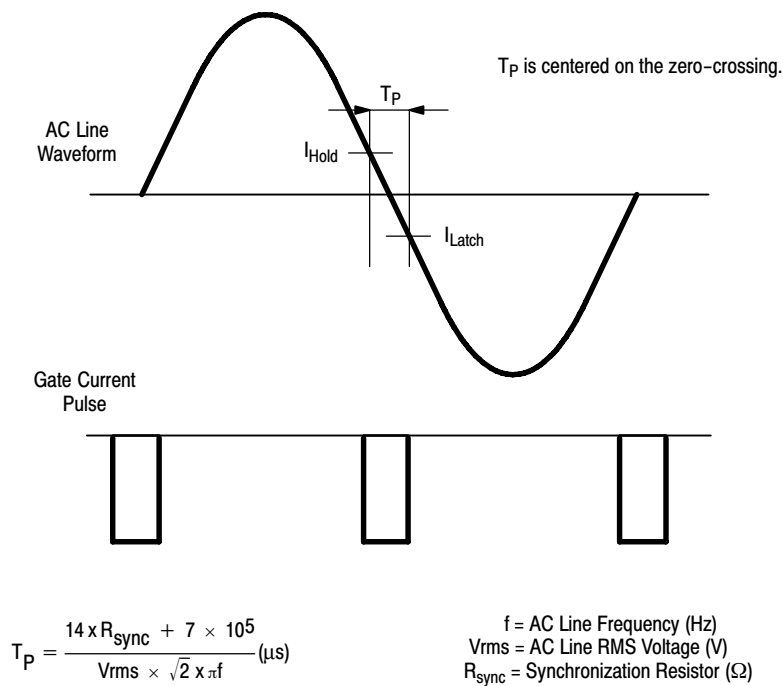

Figure 3. Zero Voltage Technique

## CIRCUIT FUNCTIONAL DESCRIPTION

**Power Supply (Pin 5 and Pin 7)**

The application uses a current source supplied by a single high voltage rectifier in series with a power dropping resistor. An integrated shunt regulator delivers a  $V_{EE}$  voltage of  $-8.6\text{ V}$  with respect to Pin 7. The current used by the total regulating system can be shared in four functional blocks: IC supply, sensing bridge, triac gate firing pulses and zener current. The integrated zener, as in any shunt regulator, absorbs the excess supply current. The 50 Hz pulsed supply current is smoothed by the large value capacitor connected between Pins 5 and 7.

**Temperature Sensing (Pin 3)**

The actual temperature is sensed by a negative temperature coefficient element connected in a resistor divider fashion. This two element network is connected between the ground terminal Pin 5 and the reference voltage  $-5.5\text{ V}$  available on Pin 1. The resulting voltage, a function of the measured temperature, is applied to Pin 3 and internally compared to a control voltage whose value depends on several elements: Sawtooth, Temperature Reduction and Hysteresis Adjust. (Refer to Application Information.)

**Temperature Reduction**

For energy saving, a remotely programmable temperature reduction is available on Pin 4. The choice of resistor  $R_1$  connected between Pin 4 and  $V_{CC}$  sets the temperature reduction level.

**Comparator**

When the noninverting input (Pin 3) receives a voltage less than the internal reference value, the comparator allows the triggering logic to deliver pulses to the triac gate. To improve the noise immunity, the comparator has an adjustable hysteresis. The external resistor  $R_3$  connected to Pin 2 sets the hysteresis level. Setting Pin 2 open makes a 10 mV hysteresis level, corresponding to  $0.15^\circ\text{C}$ . Maximum hysteresis is obtained by connecting Pin 2 to  $V_{CC}$ . In that case the level is set at  $5^\circ\text{C}$ . This configuration can be useful for low temperature inertia systems.

**Sawtooth Generator**

In order to comply with European norms, the ON/OFF period on the load must exceed 30 seconds. This is achieved by an internal digital sawtooth which performs the proportional regulation without any additional components. The sawtooth signal is added to the reference applied to the comparator inverting input. Figure 2 shows the regulation improvement using the proportional band action. Figure 4 displays a timing diagram of typical system performance using the UAA2016. The internal sawtooth generator runs at a typical 40.96 sec period. The output duty cycle drive waveform is adjusted depending on the time within the 40.96 sec period the drive needs to turn on. This occurs when the voltage on the sawtooth waveform is above the voltage provided at the Sense Input.

**Noise Immunity**

The noisy environment requires good immunity. Both the voltage reference and the comparator hysteresis minimize the noise effect on the comparator input. In addition the effective triac triggering is enabled every 1/3 sec.

**Failsafe**

Output pulses are inhibited by the “failsafe” circuit if the comparator input voltage exceeds the specified threshold voltage. This would occur if the temperature sensor circuit is open.

**Sampling Full Wave Logic**

Two consecutive zero-crossing trigger pulses are generated at every positive mains half-cycle. This ensures that the number of delivered pulses is even in every case. The pulse length is selectable by  $R_{sync}$  connected on Pin 8. The pulse is centered on the zero-crossing mains waveform.

**Pulse Amplifier**

The pulse amplifier circuit sinks current pulses from Pin 6 to  $V_{EE}$ . The minimum amplitude is 70 mA. The triac is then triggered in quadrants II and III. The effective output current amplitude is given by the external resistor  $R_{out}$ . Eventually, an LED can be inserted in series with the Triac gate (see Figure 1).

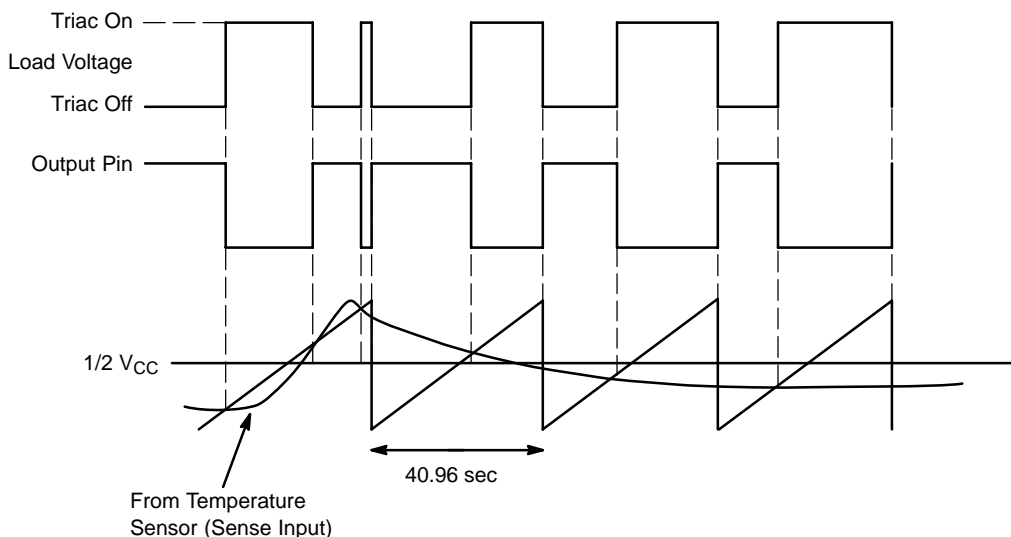

Figure 4.

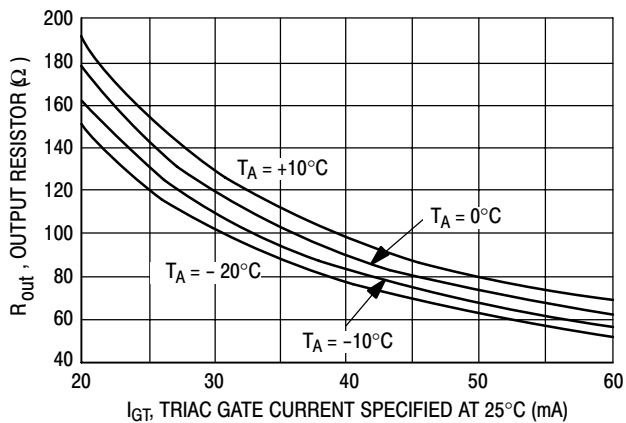

Figure 5. Output Resistor versus Triac Gate Current

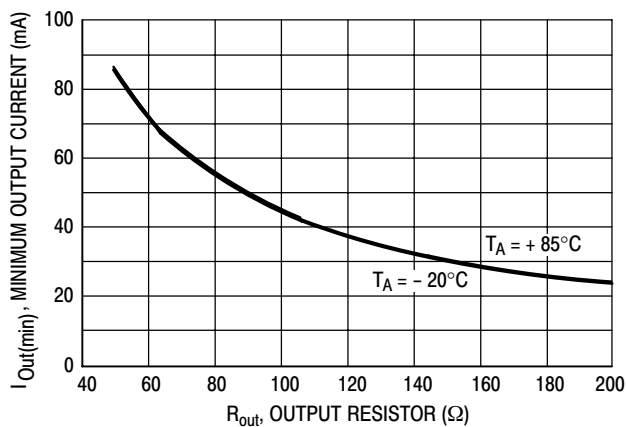

Figure 6. Minimum Output Current versus Output Resistor

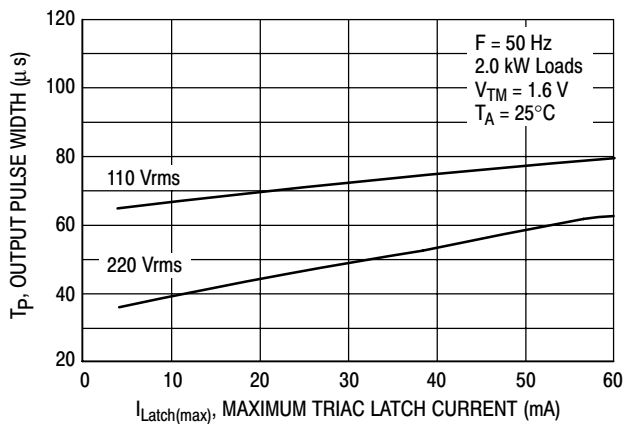

Figure 7. Output Pulse Width versus Maximum Triac Latch Current

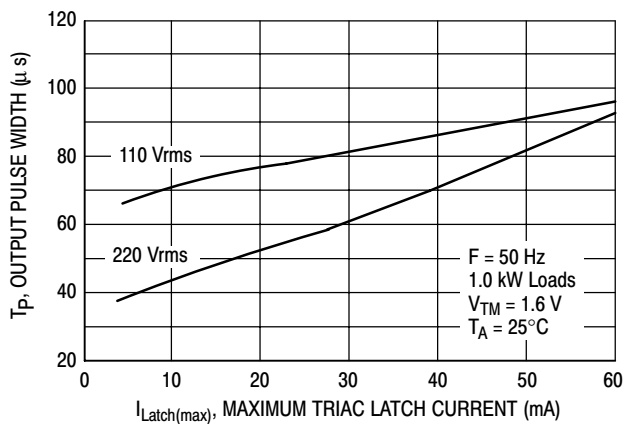

Figure 8. Output Pulse Width versus Maximum Triac Latch Current

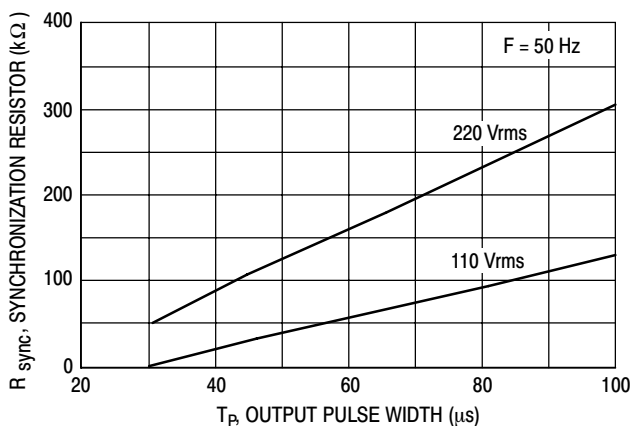

Figure 9. Synchronization Resistor versus Output Pulse Width

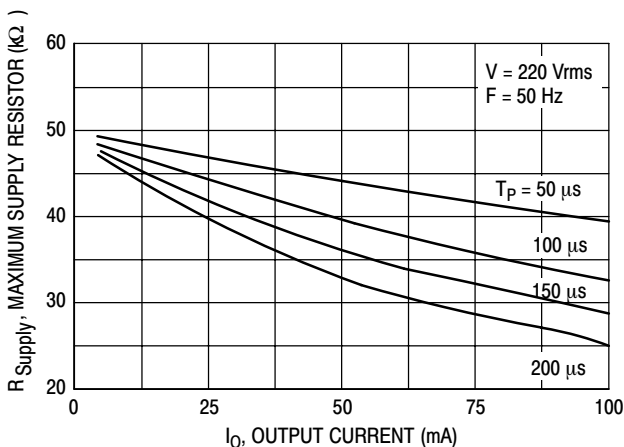

Figure 10. Maximum Supply Resistor versus Output Current

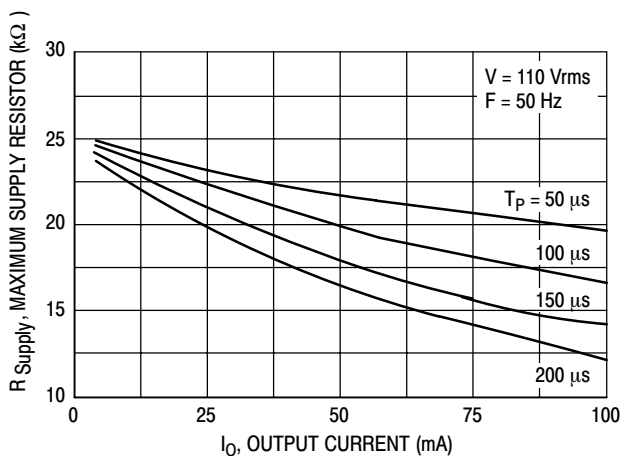

Figure 11. Maximum Supply Resistor versus Output Current

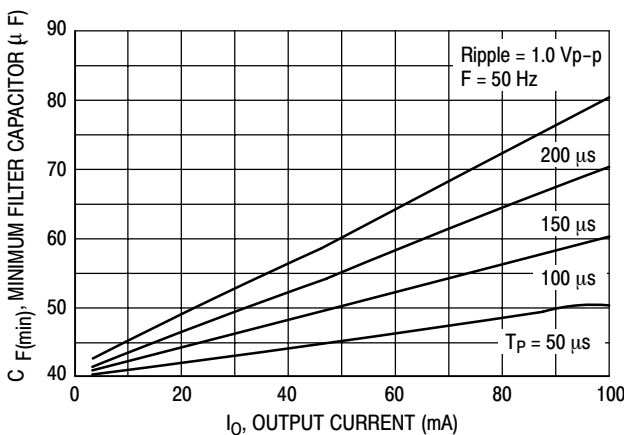

Figure 12. Minimum Filter Capacitor versus Output Current

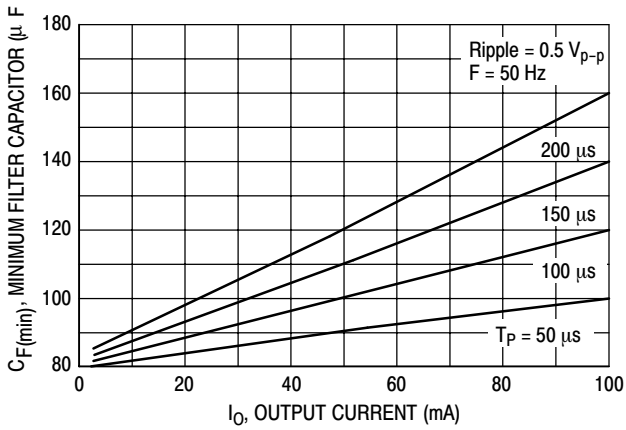

Figure 13. Minimum Filter Capacitor versus Output Current

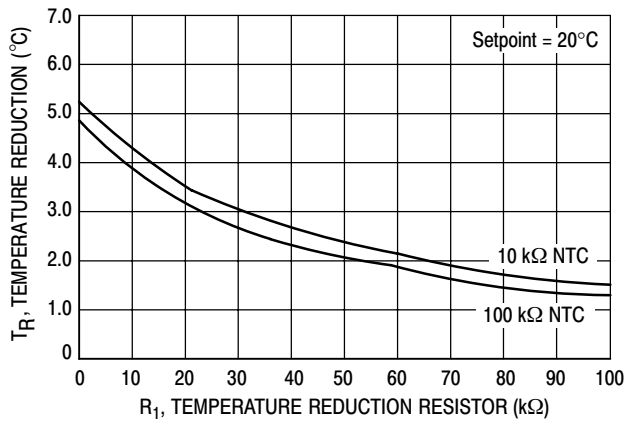

Figure 14. Temperature Reduction versus  $R_1$

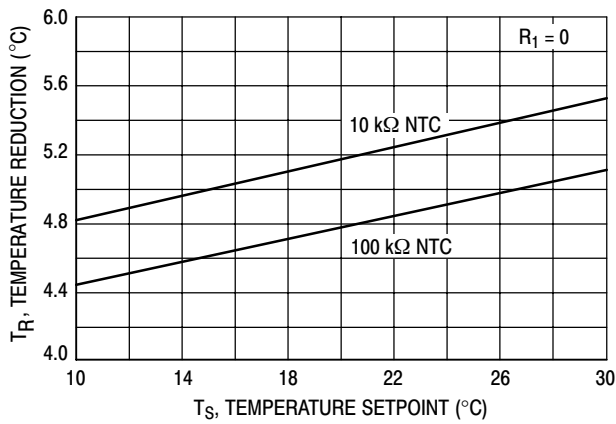

Figure 15. Temperature Reduction versus Temperature Setpoint

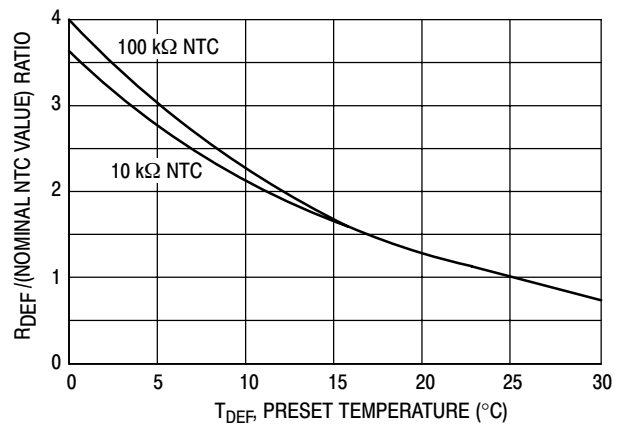

Figure 16.  $R_{DEF}$  versus Preset Temperature

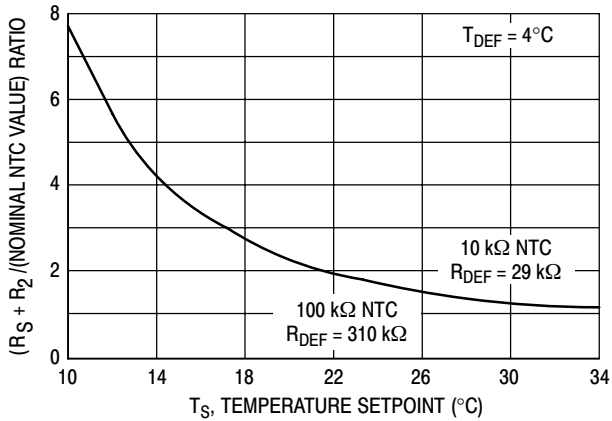

Figure 17.  $R_S + R_2$  versus Preset Setpoint

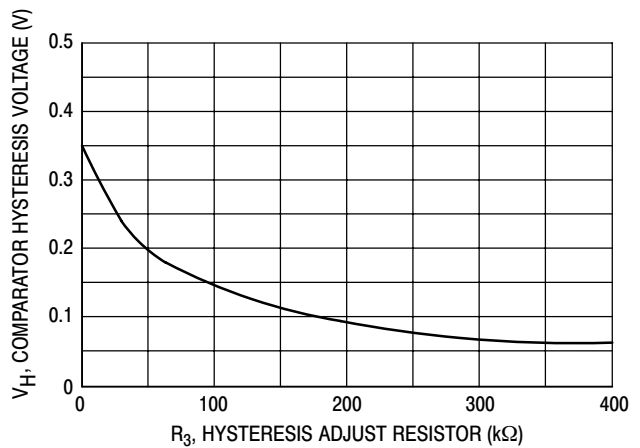

Figure 18. Comparator Hysteresis versus  $R_3$



# UAA2016

## ORDERING INFORMATION

Device	Operating Temperature Range	Package	Shipping <sup>†</sup>
UAA2016D	T <sub>A</sub> = -20° to +85°C	SOIC-8	98 Units / Rail
UAA2016DG		SOIC-8 (Pb-Free)	98 Units / Rail
UAA2016AD		SOIC-8	98 Units / Rail
UAA2016ADG		SOIC-8 (Pb-Free)	98 Units / Rail
UAA2016P		PDIP-8	1000 Units / Rail
UAA2016PG		PDIP-8 (Pb-Free)	1000 Units / Rail

<sup>†</sup>For information on tape and reel specifications, including part orientation and tape sizes, please refer to our Tape and Reel Packaging Specifications Brochure, BRD8011/D.

# MECHANICAL CASE OUTLINE

## PACKAGE DIMENSIONS

ON Semiconductor®

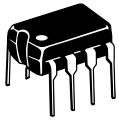

SCALE 1:1

PDIP-8  
CASE 626-05  
ISSUE P

DATE 22 APR 2015

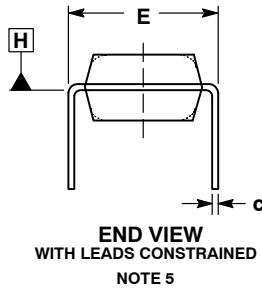
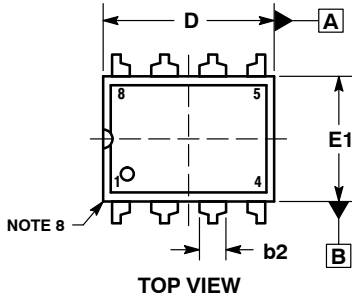

NOTES:

- DIMENSIONING AND TOLERANCING PER ASME Y14.5M, 1994.
- CONTROLLING DIMENSION: INCHES.
- DIMENSIONS A, A1 AND L ARE MEASURED WITH THE PACKAGE SEATED IN JEDEC SEATING PLANE GAUGE GS-3.
- DIMENSIONS D, D1 AND E1 DO NOT INCLUDE MOLD FLASH OR PROTRUSIONS. MOLD FLASH OR PROTRUSIONS ARE NOT TO EXCEED 0.10 INCH.
- DIMENSION E IS MEASURED AT A POINT 0.015 BELOW DATUM PLANE H WITH THE LEADS CONSTRAINED PERPENDICULAR TO DATUM C.
- DIMENSION eB IS MEASURED AT THE LEAD TIPS WITH THE LEADS UNCONSTRAINED.
- DATUM PLANE H IS COINCIDENT WITH THE BOTTOM OF THE LEADS, WHERE THE LEADS EXIT THE BODY.
- PACKAGE CONTOUR IS OPTIONAL (ROUNDED OR SQUARE CORNERS).

DIM	INCHES		MILLIMETERS	
	MIN	MAX	MIN	MAX
A	----	0.210	----	5.33
A1	0.015	----	0.38	----
A2	0.115	0.195	2.92	4.95
b	0.014	0.022	0.35	0.56
b2	0.060 TYP		1.52 TYP	
C	0.008	0.014	0.20	0.36
D	0.355	0.400	9.02	10.16
D1	0.005	----	0.13	----
E	0.300	0.325	7.62	8.26
E1	0.240	0.280	6.10	7.11
e	0.100 BSC		2.54 BSC	
eB	----	0.430	----	10.92
L	0.115	0.150	2.92	3.81
M	----	10°	----	10°

### GENERIC MARKING DIAGRAM\*

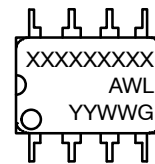

- XXXX = Specific Device Code
- A = Assembly Location
- WL = Wafer Lot
- YY = Year
- WW = Work Week
- G = Pb-Free Package

\*This information is generic. Please refer to device data sheet for actual part marking. Pb-Free indicator, "G" or microdot "▪", may or may not be present.

- STYLE 1:  
PIN 1. AC IN  
2. DC + IN  
3. DC - IN  
4. AC IN  
5. GROUND  
6. OUTPUT  
7. AUXILIARY  
8. V<sub>CC</sub>

DOCUMENT NUMBER:	98ASB42420B	Electronic versions are uncontrolled except when accessed directly from the Document Repository. Printed versions are uncontrolled except when stamped "CONTROLLED COPY" in red.
DESCRIPTION:	PDIP-8	PAGE 1 OF 1

ON Semiconductor and are trademarks of Semiconductor Components Industries, LLC dba ON Semiconductor or its subsidiaries in the United States and/or other countries. ON Semiconductor reserves the right to make changes without further notice to any products herein. ON Semiconductor makes no warranty, representation or guarantee regarding the suitability of its products for any particular purpose, nor does ON Semiconductor assume any liability arising out of the application or use of any product or circuit, and specifically disclaims any and all liability, including without limitation special, consequential or incidental damages. ON Semiconductor does not convey any license under its patent rights nor the rights of others.

# MECHANICAL CASE OUTLINE PACKAGE DIMENSIONS

ON Semiconductor®



SCALE 1:1

SOIC-8 NB  
CASE 751-07  
ISSUE AK

DATE 16 FEB 2011

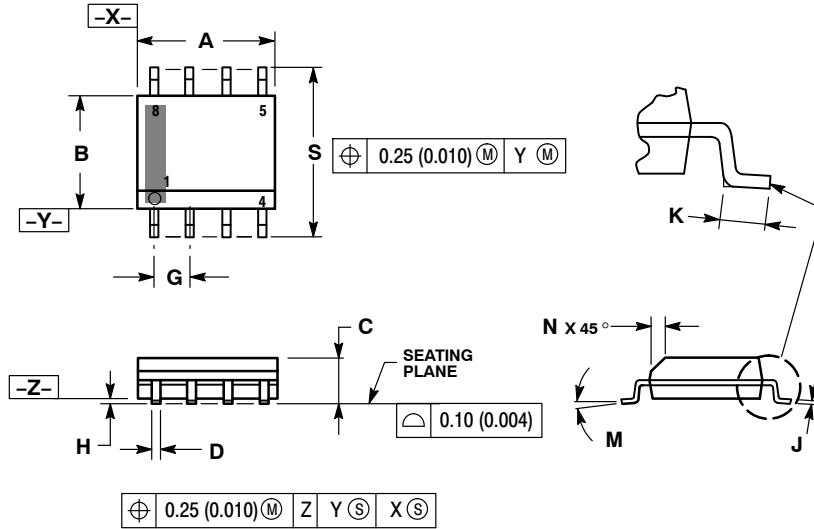

- NOTES:
1. DIMENSIONING AND TOLERANCING PER ANSI Y14.5M, 1982.
  2. CONTROLLING DIMENSION: MILLIMETER.
  3. DIMENSION A AND B DO NOT INCLUDE MOLD PROTRUSION.
  4. MAXIMUM MOLD PROTRUSION 0.15 (0.006) PER SIDE.
  5. DIMENSION D DOES NOT INCLUDE DAMBAR PROTRUSION. ALLOWABLE DAMBAR PROTRUSION SHALL BE 0.127 (0.005) TOTAL IN EXCESS OF THE D DIMENSION AT MAXIMUM MATERIAL CONDITION.
  6. 751-01 THRU 751-06 ARE OBSOLETE. NEW STANDARD IS 751-07.

DIM	MILLIMETERS		INCHES	
	MIN	MAX	MIN	MAX
A	4.80	5.00	0.189	0.197
B	3.80	4.00	0.150	0.157
C	1.35	1.75	0.053	0.069
D	0.33	0.51	0.013	0.020
G	1.27 BSC		0.050 BSC	
H	0.10	0.25	0.004	0.010
J	0.19	0.25	0.007	0.010
K	0.40	1.27	0.016	0.050
M	0°	8°	0°	8°
N	0.25	0.50	0.010	0.020
S	5.80	6.20	0.228	0.244

### SOLDERING FOOTPRINT\*



\*For additional information on our Pb-Free strategy and soldering details, please download the ON Semiconductor Soldering and Mounting Techniques Reference Manual, SOLDERRM/D.

### GENERIC MARKING DIAGRAM\*



XXXXXX = Specific Device Code  
 A = Assembly Location  
 L = Wafer Lot  
 Y = Year  
 W = Work Week  
 ■ = Pb-Free Package

XXXXXX = Specific Device Code  
 A = Assembly Location  
 Y = Year  
 WW = Work Week  
 ■ = Pb-Free Package

\*This information is generic. Please refer to device data sheet for actual part marking. Pb-Free indicator, "G" or microdot "•", may or may not be present. Some products may not follow the Generic Marking.

STYLES ON PAGE 2

DOCUMENT NUMBER:	98ASB42564B	Electronic versions are uncontrolled except when accessed directly from the Document Repository. Printed versions are uncontrolled except when stamped "CONTROLLED COPY" in red.
DESCRIPTION:	SOIC-8 NB	PAGE 1 OF 2

ON Semiconductor and ON are trademarks of Semiconductor Components Industries, LLC dba ON Semiconductor or its subsidiaries in the United States and/or other countries. ON Semiconductor reserves the right to make changes without further notice to any products herein. ON Semiconductor makes no warranty, representation or guarantee regarding the suitability of its products for any particular purpose, nor does ON Semiconductor assume any liability arising out of the application or use of any product or circuit, and specifically disclaims any and all liability, including without limitation special, consequential or incidental damages. ON Semiconductor does not convey any license under its patent rights nor the rights of others.

**SOIC-8 NB**  
**CASE 751-07**  
**ISSUE AK**

DATE 16 FEB 2011

- |  |   |   |   |
|--|---|---|---|
| <p><b>STYLE 1:</b><br/> PIN 1. EMITTER<br/> 2. COLLECTOR<br/> 3. COLLECTOR<br/> 4. EMITTER<br/> 5. EMITTER<br/> 6. BASE<br/> 7. BASE<br/> 8. EMITTER</p>   | <p><b>STYLE 2:</b><br/> PIN 1. COLLECTOR, DIE, #1<br/> 2. COLLECTOR, #1<br/> 3. COLLECTOR, #2<br/> 4. COLLECTOR, #2<br/> 5. BASE, #2<br/> 6. EMITTER, #2<br/> 7. BASE, #1<br/> 8. EMITTER, #1</p>               | <p><b>STYLE 3:</b><br/> PIN 1. DRAIN, DIE #1<br/> 2. DRAIN, #1<br/> 3. DRAIN, #2<br/> 4. DRAIN, #2<br/> 5. GATE, #2<br/> 6. SOURCE, #2<br/> 7. GATE, #1<br/> 8. SOURCE, #1</p>                            | <p><b>STYLE 4:</b><br/> PIN 1. ANODE<br/> 2. ANODE<br/> 3. ANODE<br/> 4. ANODE<br/> 5. ANODE<br/> 6. ANODE<br/> 7. ANODE<br/> 8. COMMON CATHODE</p>   |
| <p><b>STYLE 5:</b><br/> PIN 1. DRAIN<br/> 2. DRAIN<br/> 3. DRAIN<br/> 4. DRAIN<br/> 5. GATE<br/> 6. GATE<br/> 7. SOURCE<br/> 8. SOURCE</p>   | <p><b>STYLE 6:</b><br/> PIN 1. SOURCE<br/> 2. DRAIN<br/> 3. DRAIN<br/> 4. SOURCE<br/> 5. SOURCE<br/> 6. GATE<br/> 7. GATE<br/> 8. SOURCE</p>  | <p><b>STYLE 7:</b><br/> PIN 1. INPUT<br/> 2. EXTERNAL BYPASS<br/> 3. THIRD STAGE SOURCE<br/> 4. GROUND<br/> 5. DRAIN<br/> 6. GATE 3<br/> 7. SECOND STAGE Vd<br/> 8. FIRST STAGE Vd</p>                    | <p><b>STYLE 8:</b><br/> PIN 1. COLLECTOR, DIE #1<br/> 2. BASE, #1<br/> 3. BASE, #2<br/> 4. COLLECTOR, #2<br/> 5. COLLECTOR, #2<br/> 6. EMITTER, #2<br/> 7. EMITTER, #1<br/> 8. COLLECTOR, #1</p>                              |
| <p><b>STYLE 9:</b><br/> PIN 1. EMITTER, COMMON<br/> 2. COLLECTOR, DIE #1<br/> 3. COLLECTOR, DIE #2<br/> 4. EMITTER, COMMON<br/> 5. EMITTER, COMMON<br/> 6. BASE, DIE #2<br/> 7. BASE, DIE #1<br/> 8. EMITTER, COMMON</p> | <p><b>STYLE 10:</b><br/> PIN 1. GROUND<br/> 2. BIAS 1<br/> 3. OUTPUT<br/> 4. GROUND<br/> 5. GROUND<br/> 6. BIAS 2<br/> 7. INPUT<br/> 8. GROUND</p>  | <p><b>STYLE 11:</b><br/> PIN 1. SOURCE 1<br/> 2. GATE 1<br/> 3. SOURCE 2<br/> 4. GATE 2<br/> 5. DRAIN 2<br/> 6. DRAIN 2<br/> 7. DRAIN 1<br/> 8. DRAIN 1</p>   | <p><b>STYLE 12:</b><br/> PIN 1. SOURCE<br/> 2. SOURCE<br/> 3. SOURCE<br/> 4. GATE<br/> 5. DRAIN<br/> 6. DRAIN<br/> 7. DRAIN<br/> 8. DRAIN</p>   |
| <p><b>STYLE 13:</b><br/> PIN 1. N.C.<br/> 2. SOURCE<br/> 3. SOURCE<br/> 4. GATE<br/> 5. DRAIN<br/> 6. DRAIN<br/> 7. DRAIN<br/> 8. DRAIN</p>  | <p><b>STYLE 14:</b><br/> PIN 1. N-SOURCE<br/> 2. N-GATE<br/> 3. P-SOURCE<br/> 4. P-GATE<br/> 5. P-DRAIN<br/> 6. P-DRAIN<br/> 7. N-DRAIN<br/> 8. N-DRAIN</p>   | <p><b>STYLE 15:</b><br/> PIN 1. ANODE 1<br/> 2. ANODE 1<br/> 3. ANODE 1<br/> 4. ANODE 1<br/> 5. CATHODE, COMMON<br/> 6. CATHODE, COMMON<br/> 7. CATHODE, COMMON<br/> 8. CATHODE, COMMON</p>               | <p><b>STYLE 16:</b><br/> PIN 1. EMITTER, DIE #1<br/> 2. BASE, DIE #1<br/> 3. EMITTER, DIE #2<br/> 4. BASE, DIE #2<br/> 5. COLLECTOR, DIE #2<br/> 6. COLLECTOR, DIE #2<br/> 7. COLLECTOR, DIE #1<br/> 8. COLLECTOR, DIE #1</p> |
| <p><b>STYLE 17:</b><br/> PIN 1. VCC<br/> 2. V2OUT<br/> 3. V1OUT<br/> 4. TXE<br/> 5. RXE<br/> 6. VEE<br/> 7. GND<br/> 8. ACC</p>  | <p><b>STYLE 18:</b><br/> PIN 1. ANODE<br/> 2. ANODE<br/> 3. SOURCE<br/> 4. GATE<br/> 5. DRAIN<br/> 6. DRAIN<br/> 7. CATHODE<br/> 8. CATHODE</p>   | <p><b>STYLE 19:</b><br/> PIN 1. SOURCE 1<br/> 2. GATE 1<br/> 3. SOURCE 2<br/> 4. GATE 2<br/> 5. DRAIN 2<br/> 6. MIRROR 2<br/> 7. DRAIN 1<br/> 8. MIRROR 1</p>   | <p><b>STYLE 20:</b><br/> PIN 1. SOURCE (N)<br/> 2. GATE (N)<br/> 3. SOURCE (P)<br/> 4. GATE (P)<br/> 5. DRAIN<br/> 6. DRAIN<br/> 7. DRAIN<br/> 8. DRAIN</p>   |
| <p><b>STYLE 21:</b><br/> PIN 1. CATHODE 1<br/> 2. CATHODE 2<br/> 3. CATHODE 3<br/> 4. CATHODE 4<br/> 5. CATHODE 5<br/> 6. COMMON ANODE<br/> 7. COMMON ANODE<br/> 8. CATHODE 6</p>  | <p><b>STYLE 22:</b><br/> PIN 1. I/O LINE 1<br/> 2. COMMON CATHODE/VCC<br/> 3. COMMON CATHODE/VCC<br/> 4. I/O LINE 3<br/> 5. COMMON ANODE/GND<br/> 6. I/O LINE 4<br/> 7. I/O LINE 5<br/> 8. COMMON ANODE/GND</p> | <p><b>STYLE 23:</b><br/> PIN 1. LINE 1 IN<br/> 2. COMMON ANODE/GND<br/> 3. COMMON ANODE/GND<br/> 4. LINE 2 IN<br/> 5. LINE 2 OUT<br/> 6. COMMON ANODE/GND<br/> 7. COMMON ANODE/GND<br/> 8. LINE 1 OUT</p> | <p><b>STYLE 24:</b><br/> PIN 1. BASE<br/> 2. EMITTER<br/> 3. COLLECTOR/ANODE<br/> 4. COLLECTOR/ANODE<br/> 5. CATHODE<br/> 6. CATHODE<br/> 7. COLLECTOR/ANODE<br/> 8. COLLECTOR/ANODE</p>                                      |
| <p><b>STYLE 25:</b><br/> PIN 1. VIN<br/> 2. N/C<br/> 3. REXT<br/> 4. GND<br/> 5. IOUT<br/> 6. IOUT<br/> 7. IOUT<br/> 8. IOUT</p>   | <p><b>STYLE 26:</b><br/> PIN 1. GND<br/> 2. dv/dt<br/> 3. ENABLE<br/> 4. ILIMIT<br/> 5. SOURCE<br/> 6. SOURCE<br/> 7. SOURCE<br/> 8. VCC</p>  | <p><b>STYLE 27:</b><br/> PIN 1. ILIMIT<br/> 2. OVLO<br/> 3. UVLO<br/> 4. INPUT+<br/> 5. SOURCE<br/> 6. SOURCE<br/> 7. SOURCE<br/> 8. DRAIN</p>  | <p><b>STYLE 28:</b><br/> PIN 1. SW_TO_GND<br/> 2. DASIC OFF<br/> 3. DASIC_SW_DET<br/> 4. GND<br/> 5. V_MON<br/> 6. VBULK<br/> 7. VBULK<br/> 8. VIN</p>  |
| <p><b>STYLE 29:</b><br/> PIN 1. BASE, DIE #1<br/> 2. EMITTER, #1<br/> 3. BASE, #2<br/> 4. EMITTER, #2<br/> 5. COLLECTOR, #2<br/> 6. COLLECTOR, #2<br/> 7. COLLECTOR, #1<br/> 8. COLLECTOR, #1</p>                        | <p><b>STYLE 30:</b><br/> PIN 1. DRAIN 1<br/> 2. DRAIN 1<br/> 3. GATE 2<br/> 4. SOURCE 2<br/> 5. SOURCE 1/DRAIN 2<br/> 6. SOURCE 1/DRAIN 2<br/> 7. SOURCE 1/DRAIN 2<br/> 8. GATE 1</p>                           |   |   |

<b>DOCUMENT NUMBER:</b>	<b>98ASB42564B</b>	Electronic versions are uncontrolled except when accessed directly from the Document Repository. Printed versions are uncontrolled except when stamped "CONTROLLED COPY" in red.
<b>DESCRIPTION:</b>	<b>SOIC-8 NB</b>	<b>PAGE 2 OF 2</b>

ON Semiconductor and  are trademarks of Semiconductor Components Industries, LLC dba ON Semiconductor or its subsidiaries in the United States and/or other countries. ON Semiconductor reserves the right to make changes without further notice to any products herein. ON Semiconductor makes no warranty, representation or guarantee regarding the suitability of its products for any particular purpose, nor does ON Semiconductor assume any liability arising out of the application or use of any product or circuit, and specifically disclaims any and all liability, including without limitation special, consequential or incidental damages. ON Semiconductor does not convey any license under its patent rights nor the rights of others.