

RF Power MOSFET Transistor 40W, 100-500 MHz, 28V

Rev. V1

Features

- N-channel enhancement mode device
- DMOS structure
- Lower capacitances for broadband operation
- Common source configuration
- Lower noise floor

ABSOLUTE MAXIMUM RATINGS AT 25° C

Parameter	Symbol	Rating	Units
Drain-Source Voltage	V_{DS}	65	V
Gate-Source Voltage	V_{GS}	20	V
Drain-Source Current	I_{DS}	4*	A
Power Dissipation	P_D	116	W
Junction Temperature	T_J	200	°C
Storage Temperature	T_{STG}	-55 to 150	°C
Thermal Resistance	θ_{JC}	1.5	°C/W

TYPICAL DEVICE IMPEDANCES

F (MHz)	Z_{IN} (Ω)	Z_{LOAD} (Ω)
100	6.0-j20.0	25.0j27.0
300	2.5-j5.5	13.0+j13.0
500	4.0+j3.0	12.0j5.0

$V_{DD}=28V, I_{DQ}=500\text{ mA}, P_{OUT}=40.0\text{ W}$

Z_{IN} is the series equivalent input impedance of the device from gate to source.

Z_{LOAD} is the optimum series equivalent load impedance as measured from drain to ground.

ELECTRICAL CHARACTERISTICS AT 25°C

Parameter	Symbol	Min	Max	Units	Test Conditions
Drain-Source Breakdown Voltage	BV_{DSS}	65	-	V	$V_{GS} = 0.0\text{ V}, I_{DS} = 5.0\text{ mA}$
Drain-Source Leakage Current	I_{DSS}	-	1.0	mA	$V_{GS} = 28.0\text{ V}, V_{DS} = 0.0\text{ V}$
Gate-Source Leakage Current	I_{GSS}	-	1.0	μA	$V_{GS} = 20.0\text{ V}, V_{DS} = 0.0\text{ V}$
Gate Threshold Voltage	$V_{GS(TH)}$	2.0	6.0	V	$V_{DS} = 10.0\text{ V}, I_{DS} = 100.0\text{ mA}$
Forward Transconductance	G_M	.5	-	S	$V_{DS} = 10.0\text{ V}, I_{DS} = 1.0\text{ A}, \Delta V_{GS} = 1.0\text{ V}, 80\ \mu\text{s Pulse}$
Input Capacitance	C_{ISS}	-	45	pF	$V_{DS} = 28.0\text{ V}, F = 1.0\text{ MHz}$
Output Capacitance	C_{OSS}	-	30	pF	$V_{DS} = 28.0\text{ V}, F = 1.0\text{ MHz}$
Reverse Capacitance	C_{RSS}	-	8	pF	$V_{DS} = 28.0\text{ V}, F = 1.0\text{ MHz}$
Power Gain	G_P	10	-	dB	$V_{DD} = 28.0\text{ V}, I_{DQ} = 500.0\text{ mA}, P_{OUT} = 40.0\text{ W } F = 500\text{ MHz}$
Drain Efficiency	η_D	50	-	%	$V_{DD} = 28.0\text{ V}, I_{DQ} = 500.0\text{ mA}, P_{OUT} = 40.0\text{ W } F = 500\text{ MHz}$
Load Mismatch Tolerance	VSWR-T	-	20:1	-	$V_{DD} = 28.0\text{ V}, I_{DQ} = 500.0\text{ mA}, P_{OUT} = 40.0\text{ W } F = 500\text{ MHz}$

*Per side

Package Outline

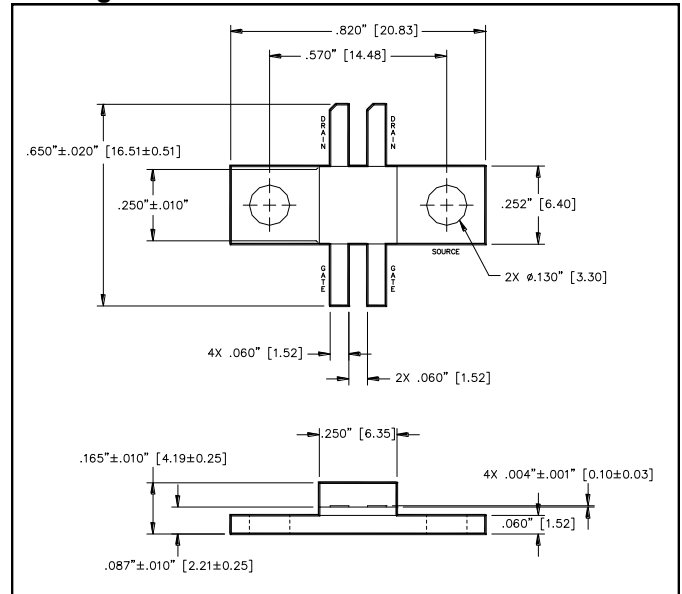

UNLESS OTHERWISE NOTED, TOLERANCES ARE INCHES $\pm .005$ " [MILLIMETERS $\pm 0.13\text{mm}$]

Typical Broadband Performance Curves

CAPACITANCES vs VOLTAGE

F=1.0MHz

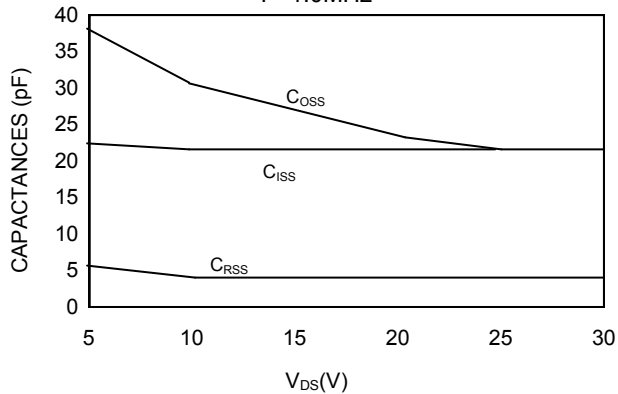

POWER OUTPUT vs VOLTAGE

$P_{IN}=3.0\text{ W}$ $I_{DQ}=500\text{ mA}$ $P_{OUT}=500\text{ W}$

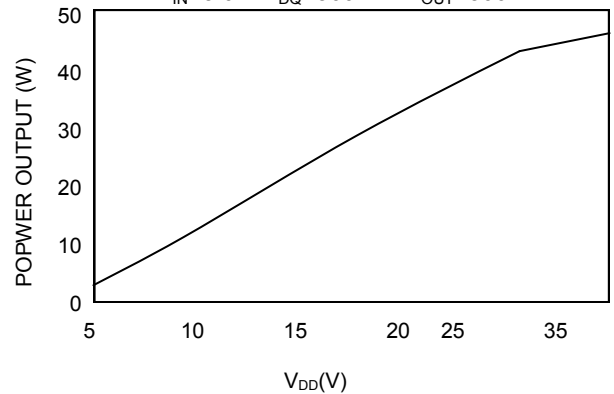

GAIN vs FREQUENCY

$V_{DD}=28\text{ V}$ $P_{OUT}=40\text{ W}$ $I_{DQ}=500\text{ mA}$

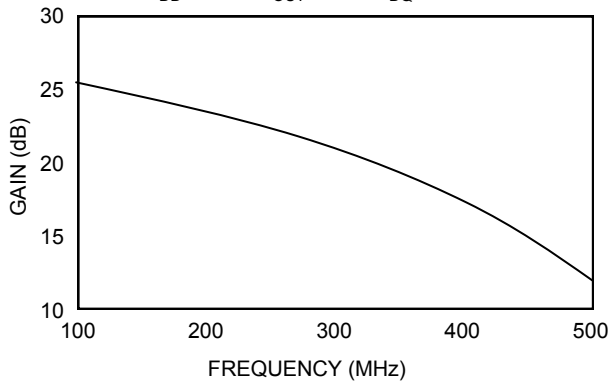

EFFICIENCY vs FREQUENCY

$V_{DD}=28\text{ V}$ $I_{DQ}=500\text{ mA}$ $P_{OUT}=40\text{ W}$

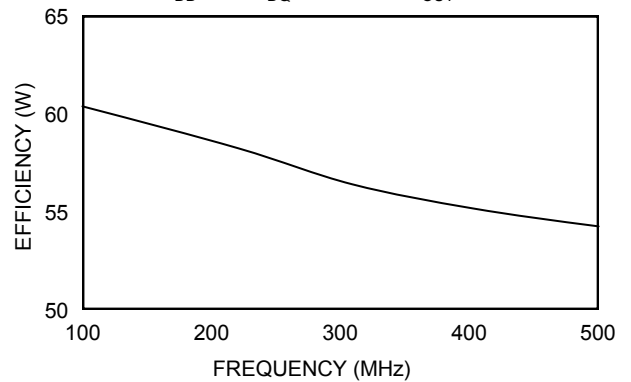

POWER OUTPUT vs POWER INPUT

$V_{DD}=28\text{ V}$ $I_{DQ}=500\text{ mA}$

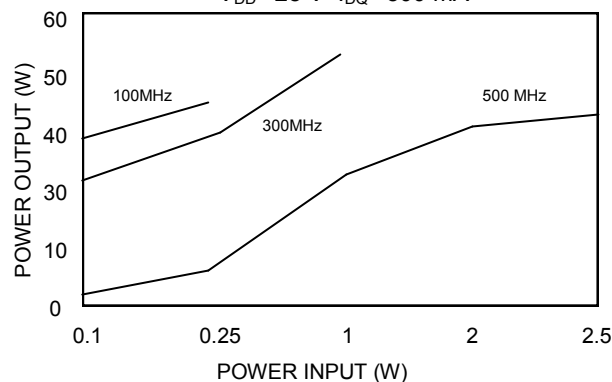

RF Power MOSFET Transistor 40W, 100-500 MHz, 28V

Rev. V1

TEST FIXTURE SCHEMATIC

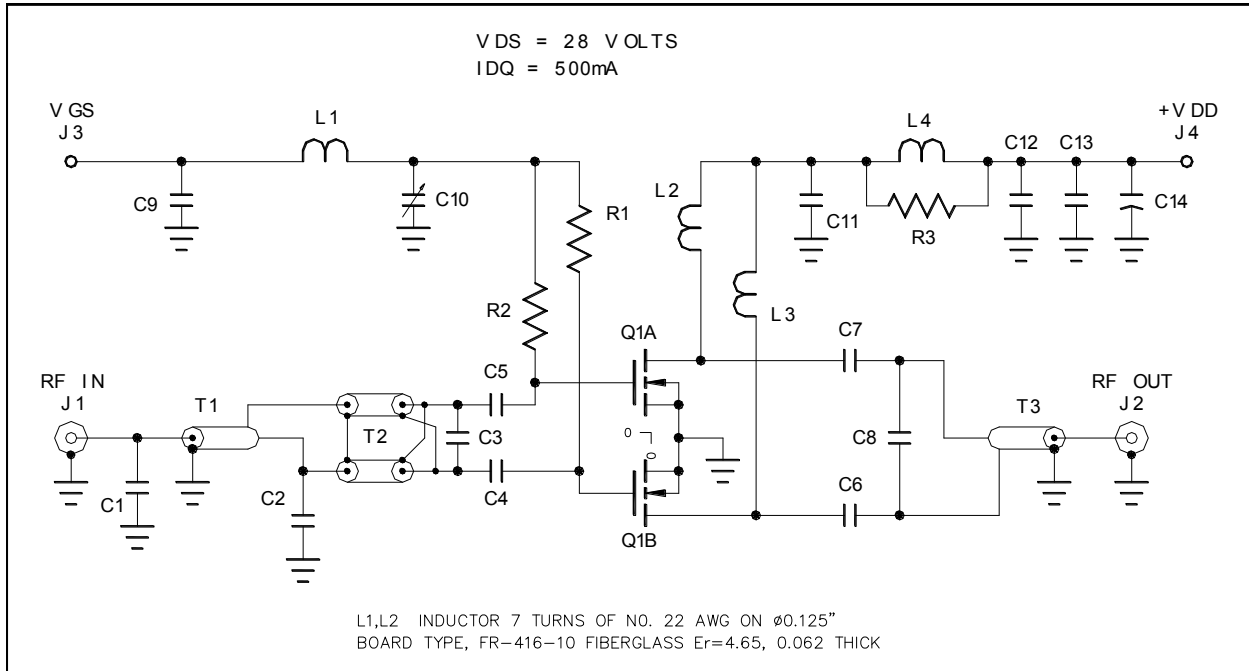

TEST FIXTURE SCHEMATIC

