

**SURFACE MOUNT GLASS PASSIVATED
 SUPER FAST SILICON RECTIFIER**

VOLTAGE RANGE 50 to 200 Volts CURRENT 1.0 Ampere

FEATURES

- * Glass passivated device
- * For surface mounted applications
- * Ultrafast recovery times for high efficiency
- * Low forward voltage, low power loss
- * Low leakage current

MECHANICAL DATA

- * Epoxy : Device has UL flammability classification 94V-0
- * Metallurgically bonded construction
- * Mounting position: Any
- * Weight: 0.057 gram

MAXIMUM RATINGS AND ELECTRICAL CHARACTERISTICS

Ratings at 25 °C ambient temperature unless otherwise specified.
 Single phase, half wave, 60 Hz, resistive or inductive load.
 For capacitive load, derate current by 20%.

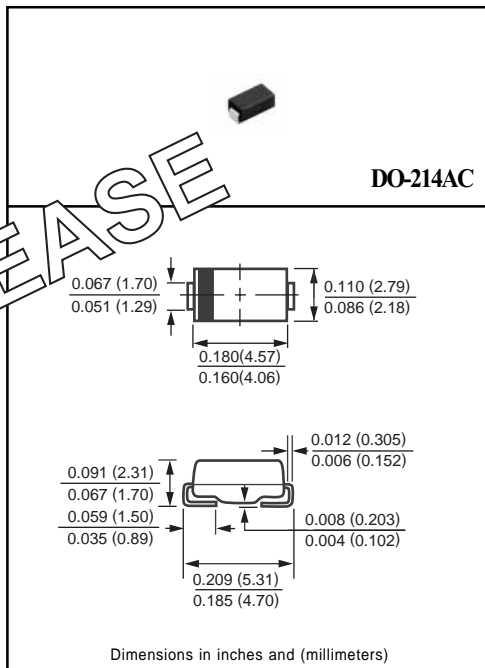

MAXIMUM RATINGS (At TA = 25°C unless otherwise noted)

RATINGS	SYMBOL	UFM101	UFM102	UFM103	UFM104	UNITS
Maximum Recurrent Peak Reverse Voltage	VRRM	50	100	150	200	Volts
Maximum RMS Volts	VRMS	35	70	105	140	Volts
Maximum DC Blocking Voltage	VDC	50	100	150	200	Volts
Maximum Average Forward Current at TA = 55°C	Io	1.0				Amps
Peak Forward Surge Current IFM (surge): 8.3 ms single half sine-wave superimposed on rated load (JEDEC method)	IFSM	30				Amps
Typical Junction Capacitance (Note 2)	CJ	7				pF
Operating and Storage Temperature Range	TJ, TSTG	-55 to + 150				°C

ELECTRICAL CHARACTERISTICS (At TA = 25°C unless otherwise noted)

CHARACTERISTICS	SYMBOL	UFM101	UFM102	UFM103	UFM104	UNITS
Maximum Forward Voltage at 1.0A DC	VF	0.92				Volts
Maximum DC Reverse Current at Rated DC Blocking Voltage	@ TA = 25°C	5.0				uAmps
	@ TA = 100°C	100				
Maximum Reverse Recovery Time (Note 1)	trr	20				nSec

NOTES : 1. Test Conditions: IF=0.5A, IR=-1.0A, IRR=-0.25A.

2. Measured at 1 MHz and applied reverse voltage of 4.0 volts.

RATING AND CHARACTERISTIC CURVES (UFM101 THRU UFM104)

FIG. 1 - TEST CIRCUIT DIAGRAM AND REVERSE RECOVERY TIME CHARACTERISTIC

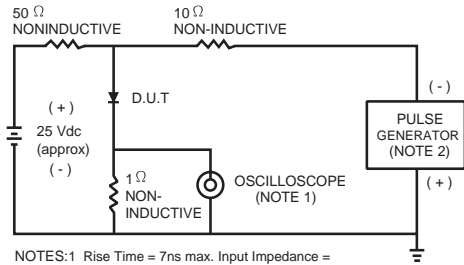

NOTES: 1. Rise Time = 7ns max. Input Impedance = 1 megohm, 22 pF.
2. Rise Time = 10ns max. Source Impedance = 50 ohms.

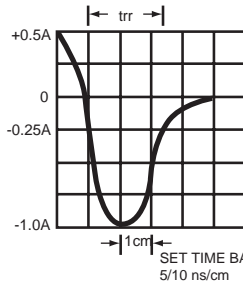

FIG. 2 - TYPICAL FORWARD CURRENT DERATING CURVE

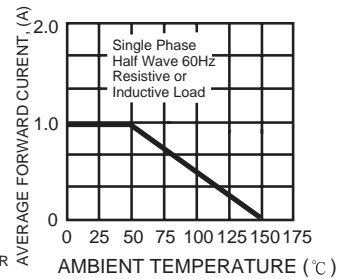

FIG. 3 - TYPICAL REVERSE CHARACTERISTICS

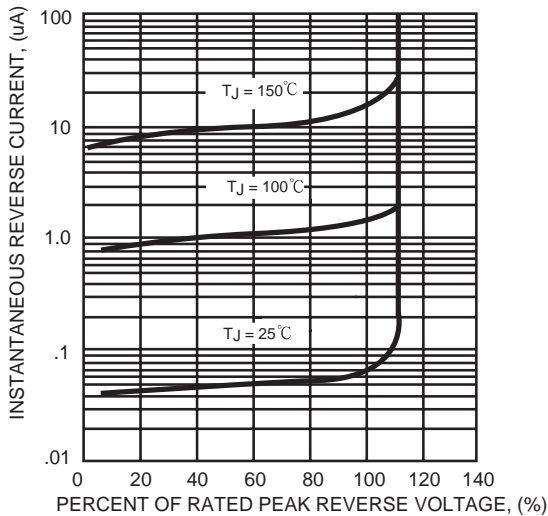

FIG. 4 - TYPICAL INSTANTANEOUS FORWARD CHARACTERISTICS

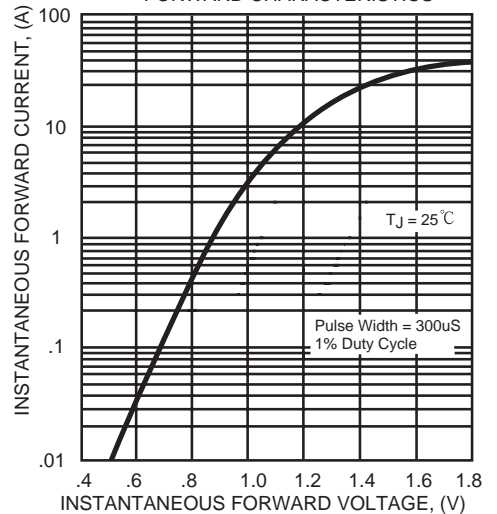

FIG. 5 - MAXIMUM NON-REPETITIVE FORWARD SURGE CURRENT

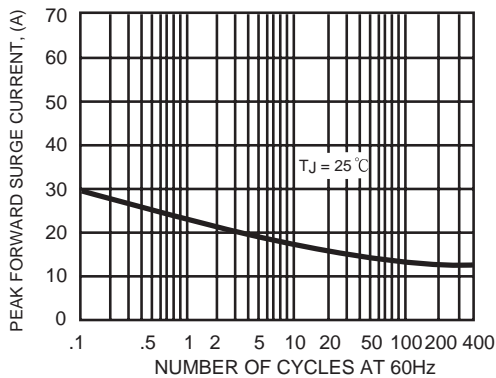

FIG. 6 - TYPICAL JUNCTION CAPACITANCE

