

UJA113x series

Buck/boost HS-CAN/(dual) LIN system basis chip

Rev. 2 — 5 July 2016

Product data sheet

1. General description

The UJA113x System Basis Chip (SBC) contains a fully integrated buck and boost converter along with a number of features commonly found in the latest generation of automotive Electronic Control Units (ECUs). It interfaces directly with CAN and LIN bus lines, supplies the microcontroller, handles input and output signals and supports fail-safe features including a watchdog and advanced 'limp home' functionality configurable via non-volatile memory. The UJA113x is available in number of variants as detailed in [Section 3](#).

To satisfy the demand for SBCs that operate at low battery supply voltages and feature low power dissipation, a switched mode power supply (SMPS) with automatic down (Buck mode) or up conversion (Boost mode) has been integrated into the UJA113x. In Boost mode, the SMPS of the UJA1131 and UJA1132 variants can continue supplying a microcontroller during dips in the battery voltage, ensuring uninterrupted operation. The boost stage of the UJA1135 and the UJA1136 has limited output current capability, and is suitable for supplying the memory in a microcontroller to prevent information being lost. The SMPS requires only a single external coil and some capacitors but no separate semiconductors.

The UJA113x implements the classic CAN physical layer as defined in the current ISO11898 standard (-2:2003, -5:2007, -6:2013). Pending the release of the upcoming version of ISO11898-2:201x including CAN FD, additional timing parameters defining loop delay symmetry are included. This implementation enables reliable communication in the CAN FD fast phase at data rates up to 2 Mbit/s.

The UJA113xFD/x variants support ISO 11898-6:2013 and ISO 11898-2:201x compliant CAN partial networking with a selective wake-up function incorporating CAN FD-passive. CAN FD-passive is a feature that allows CAN FD bus traffic to be ignored in Sleep/Standby mode. CAN FD-passive partial networking is the perfect fit for networks that support both CAN FD and classic CAN communications. It allows normal CAN controllers that do not need to communicate CAN FD messages to remain in partial networking Sleep/Standby mode during CAN FD communication without generating bus errors.

A number of configuration settings are stored in non-volatile memory. This makes it possible to adapt the power-on and limp home behavior of the UJA113x to meet the specific requirements of an application.



2. Features and benefits

2.1 General

- Generic SBC functions:
 - ◆ Fully integrated buck-boost converter
 - ◆ 5 V/3.3 V voltage regulator delivering up to 500 mA
 - ◆ Separate voltage regulator with optional protection against shorts to battery and loss of module ground
 - ◆ CAN transceiver and up to two LIN transceivers
 - ◆ Two-channel battery monitoring with integrated A/D converter
 - ◆ Watchdog with Window and Timeout modes and on-chip oscillator
 - ◆ Serial Peripheral Interface (SPI) for communicating with the microcontroller
 - ◆ ECU power management system
 - ◆ Protected general-purpose high-voltage I/O pins configurable as high-side drivers (HS), low-side drivers (LS) or wake-up inputs
 - ◆ Four internal PWM/pulse timers in derivatives containing high-voltage I/O pins (see [Table 1](#))
- Designed for automotive applications:
 - ◆ Excellent ElectroMagnetic Compatibility (EMC) performance
 - ◆ ± 6 kV ElectroStatic Discharge (ESD) protection according to the Human Body Model (HBM) on the CAN/LIN bus pins
 - ◆ ± 6 kV ElectroStatic Discharge protection according to IEC 61000-4-2 on the CAN/LIN bus pins, the sensor supply output (VEXT) and the HVIO pins
 - ◆ ± 40 V short-circuit proof CAN/LIN bus pins
 - ◆ Battery and CAN/LIN bus pins are protected against transients in accordance with ISO 7637-3
 - ◆ Very low-current Standby and Sleep modes with full wake-up capability
- Supports remote flash programming via the CAN-bus
- Compact 10 mm × 10 mm HTQFP48 package with low thermal resistance
- Dark green product (halogen free and Restriction of Hazardous Substances (RoHS) compliant)

2.2 Integrated buck and boost converter (SMPS)

- Buck and boost functions with a single external coil:
 - ◆ Automatic Buck or Boost mode selection depending on input voltage and output load conditions
 - ◆ Boost function allows the UJA1131 and UJA1132 to operate at very low supply voltages (e.g. 2 V; lowest achievable supply voltage depends on output load conditions)
 - ◆ Boost function of the UJA1135 and UJA1136 can be used to supply the volatile memory of a microcontroller down to battery voltages as low as 2 V.
 - ◆ Soft-start function
- The SMPS functions as a pre-regulator for V1 and, optionally, V2:
 - ◆ Results in excellent load response at V1 and V2
 - ◆ Results in negligible ripple at V1 and V2 outputs

- ◆ Pre-regulator output voltage selectable via the SPI
- ◆ The SMPS can be switched to Pass-through mode to ensure the lowest possible current consumption with immediate full output current capability
- The SMPS can be used to supply external loads directly:
 - ◆ e.g. as an energy-efficient supply for an LED chain

2.3 Low-drop voltage regulators (LDOs)

- Main voltage regulator V1:
 - ◆ 5 V or 3.3 V nominal output voltage (depending on the selected device)
 - ◆ 500 mA output current capability
 - ◆ capable of 500 mA transient load current jump in Standby mode
 - ◆ Current limiting above 500 mA
 - ◆ On-resistance of less than 2 Ω
 - ◆ ± 2 % accuracy
 - ◆ Undervoltage reset; selectable threshold on the 5 V version: 60 %, 70 %, 80 % or 90 % of nominal value (default detection and release at 90 %)
 - ◆ Excellent transient response with a small ceramic output capacitor
 - ◆ Short-circuit protection
 - ◆ Integrated clamp protects the microcontroller by maintaining the output voltage below 6 V, even when reverse currents of up to 50 mA are injected
 - ◆ Turned off in Sleep mode
- Auxiliary voltage regulator V2 with configurable output stage:
 - ◆ 5 V nominal output voltage
 - ◆ ± 2 % accuracy (± 1.5 % up to 5 mA output current)
 - ◆ Excellent transient response with a small ceramic output capacitor
 - ◆ Short-circuit protection
 - ◆ Current limiting above 100 mA
 - ◆ Configurable as supply for on-board loads
 - ◆ Configurable as supply for off-board loads ('sensor supply'); protected against shorts to GND and battery; loss-of-ground proof; high ESD robustness

2.4 CAN transceiver

- ISO 11898-2:201x (upcoming merged ISO 11898-2/5/6) compliant 1 Mbit/s high-speed CAN transceiver supporting CAN FD active communication up to 2 Mbit/s in the CAN FD data field
- Autonomous bus biasing according to ISO 11898-6:2013
- CAN-bus connections are truly floating when power to pin BAT is off
- UJA113xFD: selective wake-up function (ISO11898-6:2013 compliant CAN partial networking)
 - ◆ No 'false' wake-ups due to CAN FD traffic
- Separate supply pin for flexibility (e.g. can be supplied from V1 or V2)

2.5 LIN transceivers

- One or two channels depending on the selected device
- LIN 2.x compliant

- Compliant with SAE J2602
- Downward compatible with LIN 1.3
- Integrated LIN slave termination
- Improved EMC emission performance with optimized curve shaping

2.6 High-voltage I/Os (HVIOs; not available in UJA113xFD/0 variants)

- 4 or 8 general-purpose input/output pins individually configurable as high- or low-side output drivers
 - ◆ On/off control via the SPI or by mapping to one of four internal PWM timers
 - ◆ Optional direct output on/off control via another HVIO configured as an input (HVIO1 to HVIO4 controlled by HVIO5 to HVIO8 in variants with 8 HVIO pins)
 - ◆ PWM timing options include 8-bit dimming up to 250 Hz as well as periodic pulses with variable length and variable repetition rate; e.g. for cyclic contact monitoring
 - ◆ On-resistance less than 24 Ω
 - ◆ Two or more HVIOs can be combined to form a single output with increased driver capability
 - ◆ Combined into one or two banks of four HVIOs with individual supply pins for each bank; the banks can be supplied independently from the battery (≈ 12 V), the SMPS (≈ 6 V) or V1/V2 (5 V)
 - ◆ Reverse-current protection of the output in Off mode (loss-of-ground and loss-of-battery proof)
 - ◆ Open-load diagnostics and short-circuit protection and diagnostics
 - ◆ Can be configured individually to shut down in response to a battery supply undervoltage and/or overvoltage
- Individually configurable as inputs with wake-up capability
 - ◆ Selectable wake-up edge
 - ◆ Selectable wake-up threshold: ratiometric to HVIO supply pin or absolute level
 - ◆ Wake-up threshold tolerates ground offsets of up to 2.5 V
 - ◆ Wake-up source reporting via SPI
 - ◆ Continuous or periodic input level sampling; timing can be synchronized with another HVIO pin configured as an output driver for cyclic contact monitoring
- Three HVIOs can be configured individually as limp-home outputs
 - ◆ HVIO2 as static high-side driver limp-home signal
 - ◆ HVIO3 as 100 Hz, 10 % duty cycle limp-home signal
 - ◆ HVIO4 as 1.25 Hz, 50 % duty cycle limp-home signal

2.7 A/D converter for monitoring the battery voltage

- 10-bit resolution, accurate to ± 300 mV at 20 V full scale
- Two channels:
 - ◆ Measures the voltage level on pin BAT or pin BATSENSE
 - ◆ Measures the battery voltage on either side of a polarity protection diode connected to pin BATSENSE via a series resistor
- Continuous measurement on both channels
- Optional software interrupt and/or shutdown of functions when measured supply voltage is outside a defined range (undervoltage and overvoltage detection)

2.8 Power management

- Wake-up via CAN, LIN or HVIO pins with wake-up source recognition
- HVIO wake input functionality can be disabled to reduce current consumption
- Cyclic output signal for biasing various wake-up applications with selectable period and configurable on-time
- Cyclic wake-up with selectable period
- Standby mode featuring very low supply current with V1 active to maintain supply to the microcontroller
- Sleep mode featuring very low supply current with V1 off
- Sleep mode option can be disabled via non-volatile memory

2.9 System control and diagnostic features

- Watchdog that can operate in Window, Timeout (with optional cyclic wake-up) and Off Modes (with automatic re-enable if an interrupt is generated)
- Watchdog period selectable between 8 ms and 4 s
- 16-, 24- or 32-bit SPI for configuration, control and diagnosis
- 2 Interrupt output pins - one for high- and low-priority interrupts, one for high-priority interrupts; interrupts can be enabled individually:
 - ◆ V1 and V2/VEXT undervoltage; V2/VEXT overvoltage; battery over- and undervoltage; CAN, LIN and local wake-up (HVIO); CAN and HVIO diagnostics; overtemperature warning; cyclic wake-up; SPI failure
- Bidirectional reset pin with selectable reset length to support various microcontrollers; triggered, for example, by a watchdog overflow or by a V1 undervoltage event
- Limp-home output (LIMP) for activating application-specific 'limp-home' hardware in the event of a serious system malfunction
- Configuration information for selected functions stored in non-volatile memory
- Enable output (EN) for controlling safety-critical hardware; e.g. shut-down if the microcontroller fails
- Overtemperature warning and shut-down

3. Product family overview

Table 1. Feature overview of UJA113x SBC family

	Buck/high-current boost SMPS	Buck/low-current boost SMPS	V1 LDO 5 V, 500 mA	V1 LDO 3.3 V, 500 mA	V2/EXT LDO 5 V 100 mA	CAN FD transceiver up to 2 Mbit/s	CAN partial networking; CAN FD passive	1 x LIN transceivers	2 x LIN transceiver	4 x HVIOs: HS/LS driver or WAKE input	8 x HVIOs: HS/LS driver or WAKE input	4 x timers for HVIO control	Battery monitoring	Watchdog	LIMP pin	Advanced LIMP function	SPI interface	Reset output	EN pin for controlling critical hardware	Mode control: Normal, Standby, Sleep	Overtemperature warning and shutdown	HTQFP48 package
UJA1131HW/5V0	•		•		•	•		•			•	•	•	•	•	•	•	•	•	•	•	•
UJA1131HW/3V3	•			•	•	•		•			•	•	•	•	•	•	•	•	•	•	•	•
UJA1132HW/5V0	•		•		•	•			•		•	•	•	•	•	•	•	•	•	•	•	•
UJA1132HW/3V3	•			•	•	•			•		•	•	•	•	•	•	•	•	•	•	•	•
UJA1135HW/5V0		•	•		•	•		•			•	•	•	•	•	•	•	•	•	•	•	•
UJA1135HW/3V3		•		•	•	•		•			•	•	•	•	•	•	•	•	•	•	•	•
UJA1136HW/5V0		•	•		•	•			•		•	•	•	•	•	•	•	•	•	•	•	•
UJA1136HW/3V3		•		•	•	•			•		•	•	•	•	•	•	•	•	•	•	•	•
UJA1131HW/FD/5V/4	•		•		•	•	•	•		•		•	•	•	•	•	•	•	•	•	•	•
UJA1131HW/FD/3V/4	•			•	•	•	•	•		•		•	•	•	•	•	•	•	•	•	•	•
UJA1131HW/FD/5V/0	•		•		•	•	•	•					•	•	•		•	•	•	•	•	•
UJA1131HW/FD/3V/0	•			•	•	•	•	•					•	•	•		•	•	•	•	•	•
UJA1132HW/FD/5V/4	•		•		•	•	•		•	•		•	•	•	•	•	•	•	•	•	•	•
UJA1132HW/FD/3V/4	•			•	•	•	•		•	•		•	•	•	•	•	•	•	•	•	•	•
UJA1132HW/FD/5V/0	•		•		•	•	•		•				•	•	•		•	•	•	•	•	•
UJA1132HW/FD/3V/0	•			•	•	•	•		•				•	•	•		•	•	•	•	•	•

4. Ordering information

Table 2. Ordering information

Type number ^[1]	Package		
	Name	Description	Version
UJA1131HW/5V0	HTQFP48	plastic thermal enhanced thin quad flat package; 48 leads; body 10 x 10 x 1.0 mm; exposed die pad	SOT1181-2
UJA1131HW/3V3			
UJA1132HW/5V0			
UJA1132HW/3V3			
UJA1135HW/5V0			
UJA1135HW/3V3			
UJA1136HW/5V0			
UJA1136HW/3V3			
UJA1131HW/FD/5V/4			
UJA1131HW/FD/3V/4			
UJA1131HW/FD/5V/0			
UJA1131HW/FD/3V/0			
UJA1132HW/FD/5V/4			
UJA1132HW/FD/3V/4			
UJA1132HW/FD/5V/0			
UJA1132HW/FD/3V/0			

[1] UJA113x/5Vx variants contain a 5 V regulator (V1); UJA113x/3Vx variants contain a 3.3 V regulator (V1); UJA113xFD/x variants support CAN partial networking.

5. Block diagram



(1) UJA1132x and UJA1136x only

Fig 1. Block diagram of UJA113x variants without partial networking



6. Pinning information

6.1 Pinning

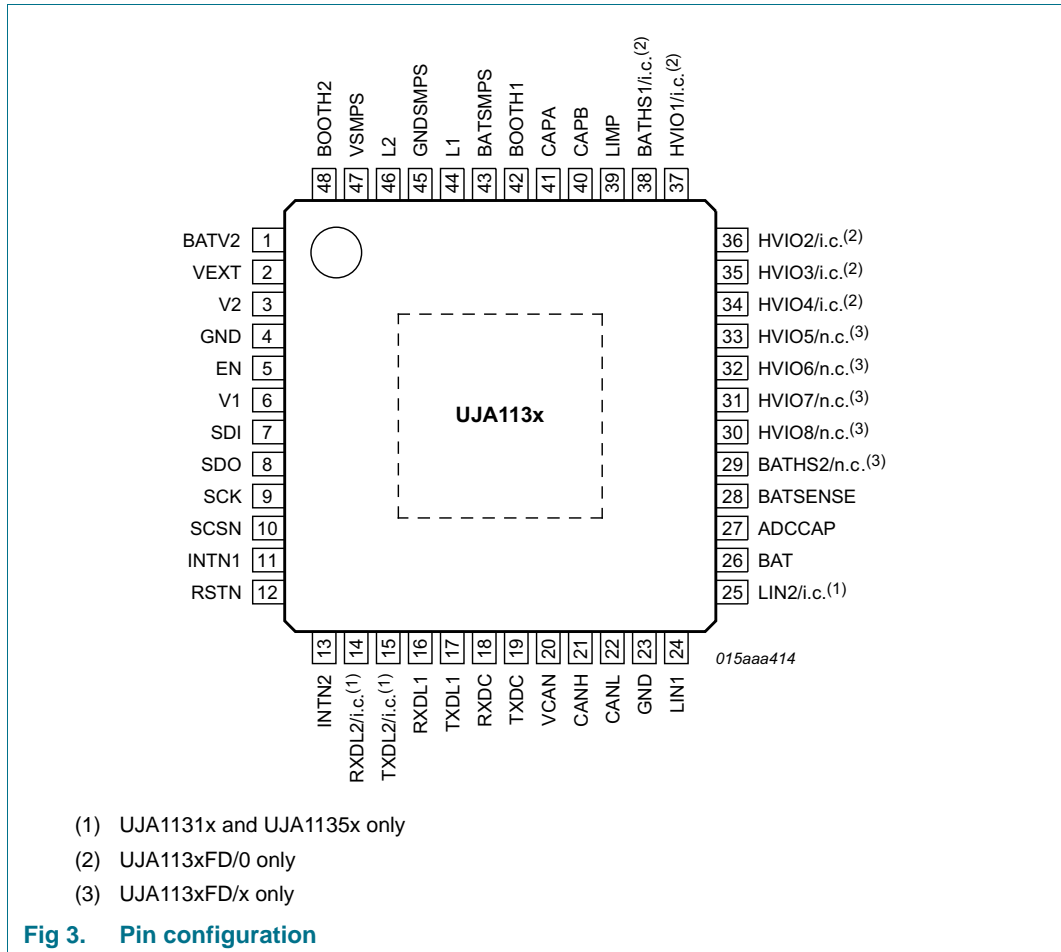

6.2 Pin description

Table 3. Pin description

Symbol	Pin	Description
BATV2	1	supply input for V2 regulator
VEXT	2	protected output of voltage regulator V2 ('sensor supply')
V2	3	protection selection for voltage regulator V2: leave pin unconnected for a protected LDO with output at VEXT; connect to pin VEXT for an unprotected LDO with lower drop-out
GND	4	ground
EN	5	enable output
V1	6	voltage regulator output for the microcontroller (5 V or 3.3 V depending on SBC version)
SDI	7	SPI data input
SDO	8	SPI data output

Table 3. Pin description ...continued

Symbol	Pin	Description
SCK	9	SPI clock input
SCSN	10	SPI chip select input
INTN1	11	interrupt output 1 to the microcontroller (triggered by all interrupts)
RSTN	12	reset input/output to and from the microcontroller; referenced to V1 (see Section 7.3.1)
INTN2	13	interrupt output 2 to the microcontroller (triggered by high-priority interrupts)
RXDL2/i.c	14	LIN2 receive data output; internally connected and should be left open in UJA1131x and UJA1135x
TXDL2/i.c.	15	LIN2 transmit data input; internally connected and should be left open in UJA1131x and UJA1135x
RXDL1	16	LIN1 receive data output
TXDL1	17	LIN1 transmit data input
RXDC	18	CAN receive data output
TXDC	19	CAN transmit data input
VCAN	20	5 V supply input for the integrated HS-CAN transceiver
CANH	21	CANH bus line
CANL	22	CANL bus line
GND	23	ground
LIN1	24	LIN bus line 1
LIN2/i.c.	25	LIN bus line 2; internally connected and should be left open in UJA1131x and UJA1135x
BAT	26	battery supply for the LIN transceiver; input source 0 for battery A/D converter
ADCCAP	27	connection for A/D converter source 0 input filter capacitor
BATSENSE	28	battery A/D converter source 1 input
BATHS2/n.c.	29	battery supply input for HVIO 5, 6, 7 and 8 (bank 1); not connected in UJA113xFD/x
HVIO8/n.c.	30	high voltage input/output 8; not connected in UJA113xFD/x
HVIO7/n.c.	31	high voltage input/output 7; not connected in UJA113xFD/x
HVIO6/n.c.	32	high voltage input/output 6; not connected in UJA113xFD/x
HVIO5/n.c.	33	high voltage input/output 5; not connected in UJA113xFD/x
HVIO4/i.c.	34	high voltage input/output 4; internally connected in UJA113xFD/0
HVIO3/i.c.	35	high voltage input/output 3; internally connected in UJA113xFD/0
HVIO2/i.c.	36	high voltage input/output 2; internally connected in UJA113xFD/0
HVIO1/i.c.	37	high voltage input/output 1; internally connected in UJA113xFD/0
BATHS1/i.c.	38	battery supply input for HVIO 1, 2, 3 and 4 (bank 0); internally connected and should be left open in UJA113xFD/0
LIMP	39	limp home output
CAPB	40	terminal B for SMPS bootstrap capacitor
CAPA	41	terminal A for SMPS bootstrap capacitor
BOOTH1	42	terminal for bootstrap capacitor 1 (connected between BOOTH1 and L1)
BATSMPS	43	battery supply input for SMPS
L1	44	SMPS coil terminal 1

Table 3. Pin description ...continued

Symbol	Pin	Description
GNDMPS	45	ground connection for SMPS
L2	46	SMPS coil terminal 2
VSMPS	47	SMPS output voltage
BOOTH2	48	terminal for bootstrap capacitor 2 (connected between BOOTH2 and L2)

The exposed die pad at the bottom of the package allows for better heat dissipation from the SBC via the printed-circuit board. It is internally connected to GND (pins 4, 23) and must be connected to ground on the PCB.

7. Functional description

7.1 System Controller

The system controller manages register configuration and controls the internal functions of the SBC. Detailed device status information is collected and made available to the microcontroller. The system controller also generates reset and interrupt signals.

7.1.1 Operating modes

The system controller is a state machine. SBC operating modes and state transitions are illustrated in [Figure 4](#). A detailed hardware characterization of the SBC operating modes by functional block is given in [Table 4](#).

7.1.1.1 Off mode

The UJA113x switches to Off mode when the battery supply voltage is too low to power the SBC.

When the battery is initially connected, the UJA113x powers up in Off mode. As soon as the battery supply rises above the power-on detection threshold ($V_{th(det)pon}$), the SBC executes a system reset and enters Standby mode. It switches automatically to Off mode from all other modes if the battery supply voltage and the SMPS output voltage fall below the power-off threshold ($V_{th(det)poff}$). In Off mode, the voltage regulators are disabled and the CAN and LIN bus systems are in a high-resistive state.

7.1.1.2 Standby mode

Standby mode is a low-power mode in which regulator V1 is switched on.

The SBC switches to Standby mode via Reset mode:

- from Off mode if the battery voltage rises above the power-on detection threshold ($V_{th(det)pon}$)
- from Overload mode when the battery voltage is below the overvoltage detection threshold ($V_{th(det)ov}$) and the chip temperature is below the overtemperature protection release threshold, $T_{th(rel)otp}$, (provided the reset counter does not overflow; i.e. $RCC < 3$, see [Section 7.3](#))
- from Sleep mode in response to a regular or diagnostic interrupt (see [Section 7.12](#)) provided $RCC < 3$ on entering Reset mode
- from Normal mode in the event of a reset event, provided $RCC < 3$ on entering Reset mode

Standby mode can also be selected from Normal mode via an SPI command (MC = 100; see [Table 5](#)).

The SBC exits Standby mode if:

- Normal or Sleep mode is selected via an SPI command
- a reset event is generated
- the global chip temperature rises above the OverTemperature Protection (OTP) activation threshold, $T_{th(act)otp}$, causing the SBC to enter Overload mode
- the battery voltage rises above the overvoltage detection threshold ($V_{th(det)ov}$), causing the SBC to enter Overload mode
- the battery supply voltage and the SMPS output voltage fall below the power-off threshold ($V_{th(det)poff}$), causing the SBC to switch to Off mode

7.1.1.3 Normal mode

Normal mode is the active SBC operating mode. In this mode, the SBC is fully operational and all onboard hardware can be activated.

Normal mode can be selected from Standby mode via an SPI command (MC = 111).

The SBC immediately exits Normal mode if:

- a reset event is triggered
- Standby or Sleep mode is selected via the SPI (MC = 100 or MC = 001)
- the global chip temperature rises above the OTP activation threshold, $T_{th(act)otp}$, causing the SBC to enter Overload mode
- the battery voltage rises above the overvoltage detection threshold ($V_{th(det)ov}$), causing the SBC to enter Overload mode
- the battery supply voltage and the SMPS output voltage fall below the power-off threshold ($V_{th(det)poff}$), causing the SBC to switch to Off mode

Remark: When the UJA113x enters Normal mode, the following features are activated after a short delay ($t_{d(act)norm}$; see [Table 91](#)): CAN and LIN transceivers, battery monitoring, HVIO low side drivers.



Fig 4. UJA113x system controller

7.1.1.4 Sleep mode

Sleep mode is a low-power mode similar to Standby mode. However, V1 is switched off in Sleep mode.

Sleep mode is selected from Normal or Standby mode via an SPI command (MC = 001). The SBC switches to Sleep mode when this command is received, provided there are no pending interrupts or wake-up events and at least one regular wake-up source is enabled (see Section 7.12.2). Any attempt to enter Sleep mode while one of these conditions has not been met will trigger a system reset and set the reset source status bits (RSS) to 10100 ('illegal Sleep mode command received'; see Table 6).

Sleep mode can be deactivated by setting the Sleep control bit (SLPC) in the SBC configuration register to 1 (see [Table 9](#)). This register is located in the non-volatile memory area of the device. When this bit is set to 1, the Sleep mode command is ignored. No other SBC functions are affected.

If the reset counter overflows when the SBC is in Reset mode, it switches to Forced Sleep Preparation (FSP) mode. The reset counter is cleared and limp home activated in FSP mode. The SBC then switches automatically to Sleep mode, provided $SLPC = 0$ (if $SLPC = 1$, it returns to Reset mode).

Since V1 is off in Sleep mode, the only way the SBC can exit Sleep mode is via a wake-up event. This can be a regular or a diagnostic wake-up event (see [Section 7.12](#)).

7.1.1.5 Overload mode

Overload mode is provided to prevent the device being damaged in critical situations. The SBC switches immediately to Overload mode:

- from any mode other than Off mode if the global chip temperature rises above the overtemperature protection activation threshold, $T_{th(act)otp}$
- if the battery voltage remains above the overvoltage detection threshold ($V_{th(det)ov}$) for longer than the overvoltage detection time, $t_{det(ov)}$

The SBC generates overtemperature and overvoltage/load dump shutdown warning interrupts to help prevent the loss of data in the microcontroller memory in the event of a critical overtemperature/overload event (see [Section 7.6](#) and [Section 7.8.3](#)).

In Overload mode, the voltage regulators are switched off, pin RSTN is driven LOW and the limp home control bit, LHC, is set to 1 so that the LIMP pin is driven LOW (see [Section 7.5](#)). In addition, the SMPS is off, the bus systems are in a high-resistive state and the HVIOs are in a fail-safe state (see [Section 7.10.4](#)).

The SBC exits Overload mode when,

- the global chip temperature is below $T_{th(rel)otp}$ and $V_{BAT} < V_{th(det)ov}$
- the device is forced to Off mode (supply voltage $< V_{th(det)poff}$)

After leaving Overload mode, the SBC generates a system reset and enters Standby mode.

7.1.1.6 Reset mode

The SBC switches to Reset mode in response to a reset event (see [Section 7.3](#)). This ensures that pin RSTN is pulled down for a defined period to allow the microcontroller to start up in a controlled manner. In addition, Reset mode provides a number of fail-safe features including a reset counter and a reset watchdog.

The SBC exits Reset mode if:

- the device is forced to Off or Overload mode
- the reset event has been processed and pin RSTN has been switched HIGH again; the SBC then switches to Standby mode
- the reset counter overflows causing the SBC to switch to Sleep mode via FSP mode

7.1.1.7 Forced Sleep Preparation (FSP) mode

FSP mode is an intermediate state that is activated in the event of a serious system failure. In FSP mode, all control settings are reset to safe values to avoid deadlocks and to ensure that the system starts up correctly once the failure condition has been eliminated. In FSP mode, all pending interrupts are cleared and all regular interrupt sources are activated (see [Table 56](#)). In addition, bit LHC bit is set to 1 to activate the limp home function (See [Table 12](#)).

The SBC switches to FSP mode from Reset mode if the reset counter overflows.

7.1.1.8 Forced Normal mode

Forced Normal mode is a test mode intended for initial prototyping and device evaluation in the laboratory. It simplifies SBC testing, is useful for failure detection and can be used for first factory flashing of the microcontroller during production.

The CAN and LIN transceivers, the SMPS, V1 and V2 are on in Forced Normal mode. The HVIOs and the watchdog are disabled and there is limited access to the SPI registers. Only the Main status register (address 0x03), the Watchdog status register (address 0x05), the Identification registers (addresses 0x7E and 0x7F) and the registers in non-volatile memory (addresses 0x70 and 0x75) can be read. The non-volatile memory can be reprogrammed provided the SBC is in the factory preset state (see [Section 7.13](#) for details).

The SBC switches to Forced Normal mode after power-on if bit FNMC in the SBC configuration and control register ([Table 9](#)) is set to 1. After the initial power-on reset sequence has been completed, system reset is disabled. So the SBC cannot force a reset and will not react to external reset events.

The SBC exits Forced Normal mode if:

- the non-volatile memory is (re-)programmed
- the SBC switches to Overload or Off mode

A system reset is performed when the SBC exits Forced Normal mode.

7.1.1.9 Hardware characterization for the SBC operating modes

Note that the digital interface pins may be inactive when the voltage on V1 drops below the V1 undervoltage threshold (see [Section 7.8.5.1](#)).

Table 4. Hardware characterization by functional block

Block	Operating mode							FSP
	Off	Forced Normal	Standby	Normal	Sleep	Reset	Overload	
V1	off	on	on	on	off	on	off	on
V2/VEXT	off	on	V2C ^[1]	V2C ^[1]	V2C ^[1]	V2C ^[1]	off	V2C ^[1]
HVION ^[2]	off	off	HVION control register; low-side drivers disabled ^[3]	HVION control register ^[3]	HVION control register; low-side drivers disabled ^[3]	HVION control register; low-side drivers disabled ^[3]	fail-safe state ^[4]	HVION control register; low-side drivers disabled ^[3]

Table 4. Hardware characterization by functional block ...continued

Block	Operating mode							
	Off	Forced Normal	Standby	Normal	Sleep	Reset	Overload	FSP
SMPS	off	on (default voltage)	SMPS control register ^[5]	SMPS control register ^[5]	SMPS control register ^[5]	on	off	on
CAN	CAN Off	CAN Active/ CAN Listen-only	CAN Offline/ CAN Offline Bias/ CAN Listen-only ^[6]	CAN Active/ CAN Offline/ CAN Offline Bias/ CAN Listen-only/ CAN Off if CAN shut down condition true ^[6]	CAN Offline/ CAN Offline Bias	CAN Offline/ CAN Offline Bias	CAN Off	CAN Offline/ CAN Offline Bias
LIN1/ LIN2 ^[7]	LIN Off	LIN Active	LIN Offline/ LIN Listen-only ^[8]	LIN Active/ LIN Listen-only/ LIN Offline ^[8]	LIN Offline	LIN Offline	LIN Off	LIN Offline
EN	off	off	ENC/ENDC ^[9]	ENC/ENDC ^[9]	ENC/ ENDC ^{[9][10]}	ENC/ ENDC ^[9]	off	ENC/ ENDC ^[9]
RSTN	LOW	HIGH	HIGH	HIGH	LOW	LOW	LOW	LOW
LIMP	floating	floating	LHC ^[11]	LHC ^[11]	LHC ^[11]	LHC ^[11]	LHC = 1	LHC = 1
RXDC	pull-up to V1	CAN status	pull-up to V1; LOW if CAN wake-up; CAN status if CMC = 11	CAN status if CMC = 01/10; otherwise same as Standby	pull-up to V1	pull-up to V1/LOW if CAN wake-up	pull-up to V1	pull-up to V1
RXDL1/ RXDL2 ^[7]	pull-up to V1	LIN status	pull-up to V1; LOW if LIN wake-up; LIN status if LMC = 11	LIN status if LMC = 01/10; otherwise same as Standby	pull-up to V1	pull-up to V1/LOW if LIN wake-up	pull-up to V1	pull-up to V1
SPI	disabled	limited access	active	active	disabled	disabled	disabled	disabled
Watchdog	off	off	WMC ^[12]	WMC ^[12]	WMC ^[12]	off	off	off

- [1] Determined by the setting of bits V2C in the Regulator control register (see [Table 25](#)).
- [2] HVIO availability depends on the device variant (see [Table 1](#)).
- [3] Determined by the settings in the relevant HVIO control register (see [Section 7.10.7](#)).
- [4] See [Section 7.10.4](#).
- [5] Determined by the settings in the SMPS control register (see [Table 23](#)).
- [6] Determined by the setting of bits CMC in the CAN control register (see [Table 26](#)).
- [7] Availability of LIN2 depends on the device variant (see [Table 1](#)).
- [8] Determined by the setting of bits LMCn in the LIN control register (see [Table 27](#)).
- [9] Determined by the settings of bits ENC and ENDC in the Fail-safe control register (see [Table 12](#)).
- [10] Since V1 is off, EN can only operate as open-drain output in Sleep mode
- [11] Determined by the setting of bit LHC in the Fail-safe control register (see [Table 12](#)).
- [12] Determined by the setting of bits WMC in the Watchdog control register (see [Table 7](#)).

7.1.2 System control registers

The operating mode is selected via bits MC in the Mode control register. The Mode control register is accessed via SPI address 0x01 (see also [Section 7.16.2](#)).

Table 5. Mode control register (address 01h)

Bit	Symbol	Access	Value	Description
7:3	reserved	R	-	
2:0	MC	R/W	001	Sleep mode
			100	Standby mode
			111	Normal mode

The Main SBC status register can be accessed to monitor the status of the overtemperature warning flag and to determine whether the SBC has entered Normal mode after power-up. It also indicates the source of the most recent reset event.

Table 6. Main SBC status register (address 03h)

Bit	Symbol	Access	Value	Description
7	reserved	R	-	
6	OTWS	R	0	IC temperature below overtemperature warning threshold
			1	IC temperature above overtemperature warning threshold
5	NMS	R	0	SBS has entered Normal mode (after leaving Off mode)
			1	SBS powered up but has not yet switched to Normal mode
4:0	RSS	R		source of most recent reset event:
			00000	exited Off mode (power-on)
			00001	CAN wake-up detected in Sleep mode
			00010	LIN1 wake-up detected in Sleep mode
			00011	LIN2 wake-up detected in Sleep mode (if LIN2 is available)
			00100	HVIO1 wake-up detected in Sleep mode (if dedicated HVIO is available)
			00101	HVIO2 wake-up detected in Sleep mode (if dedicated HVIO is available)
			00110	HVIO3 wake-up detected in Sleep mode (if dedicated HVIO is available)
			00111	HVIO4 wake-up detected in Sleep mode (if dedicated HVIO is available)
			01000	HVIO5 wake-up detected in Sleep mode (if dedicated HVIO is available)
			01001	HVIO6 wake-up detected in Sleep mode (if dedicated HVIO is available)
			01010	HVIO7 wake-up detected in Sleep mode (if dedicated HVIO is available)
			01011	HVIO8 wake-up detected in Sleep mode (if dedicated HVIO is available)
			01100	watchdog overflow in Sleep mode
			01101	diagnostic wake-up in Sleep mode
			01110	watchdog triggered too early
			01111	watchdog overflow
			10000	illegal watchdog mode control access
10001	RSTN pulled down externally			
10010	leaving Overload mode			
10011	V1 undervoltage event			
10100	illegal Sleep mode command received			
10101	wake-up after leaving FSP mode			

7.2 Watchdog

The UJA113x contains a watchdog that supports three operating modes: Window, Timeout and Autonomous. In Window mode (available only in SBC Normal mode), a watchdog trigger event within a closed watchdog window resets the watchdog timer. In Timeout mode, the watchdog runs continuously and can be reset at any time within the time-out time by a watchdog trigger. Watchdog Timeout mode can also be used for cyclic wake-up of the microcontroller. In Autonomous mode, the watchdog can be off or in Timeout mode.

The watchdog mode and watchdog period are selected via the Watchdog control register (Table 7) and can only be changed when the SBC is in Standby mode.

The watchdog mode is selected via bits WMC. If Window mode is selected (WMC = 100), the watchdog remains in (or switches to) Timeout mode until the SBC enters Normal mode. Any attempt to change the watchdog operating mode (via WMC) while the SBC is in Normal mode will cause the UJA113x to switch to Reset mode and the reset source status bits (RSS) will be set to 10000 ('illegal watchdog mode control access'; see Table 6).

Eight watchdog periods are supported, from 8 ms to 4096 ms. The watchdog period is programmed via bits NWP. The selected period is valid for both Window and Timeout modes. The default watchdog period is 128 ms.

A watchdog trigger event resets the watchdog timer. A watchdog trigger event is any valid write access to the Watchdog control register. If the watchdog mode or the watchdog period have changed as a result of the write access, the new values are valid immediately.

Table 7. Watchdog control register (address 00h)

Bit	Symbol	Access	Value	Description
7:5	WMC	R/W		watchdog mode control:
			001 ^[1]	Autonomous mode
			010 ^[2]	Timeout mode
			100 ^[3]	Window mode
4	reserved	R	-	
3:0	NWP	R/W		nominal watchdog period
			1000	8 ms
			0001	16 ms
			0010	32 ms
			1011	64 ms
			0100 ^[2]	128 ms
			1101	256 ms
			1110	1024 ms
	0111	4096 ms		

[1] Default value if SDMC = 1 (see Section 7.2.1)

[2] Default value.

[3] Selected in Standby mode but only activated when the SBC switches to Normal mode.

The watchdog is a valuable safety mechanism, so it is critical that it is configured correctly. Two features are provided to prevent watchdog parameters being changed by mistake:

- redundant states associated with configuration bits WMC and NWP
- reconfiguration protection in Normal mode

Redundant states associated with control bits WMC and NWP ensure that a single bit error cannot cause the watchdog to be configured incorrectly (at least 2 bits must be changed to reconfigure WMC or NWP). If an attempt is made to write an invalid code to WMC or NWP (e.g. 011 or 1001 respectively), the SPI operation is abandoned and an SPI failure interrupt is generated, if enabled (see [Section 7.12](#)).

Two operating modes have a major impact on the operation of the watchdog: Forced Normal mode and Software Development mode (Software Development mode is provided for test purposes and is not an SBC operating mode; the UJA113x can be in any mode with Software Development mode enabled; see [Section 7.2.1](#)). These modes are enabled and disabled via bits FNMC and SDMC respectively in the SBC configuration control register (see [Table 9](#)). This register is located in the non-volatile memory area (see [Section 7.13](#)). In Forced Normal mode (FNM), the watchdog is disabled. In Software Development mode (SDM), the watchdog can be disabled or activated for test purposes.

Information on the status of the watchdog is available from the Watchdog status register ([Table 10](#)). This register also indicates whether Forced Normal and Software Development modes are active.

Table 8. Summary of watchdog settings

System controller state	Watchdog configuration			
	SDMC = x	SDMC = x	SDMC = 0	SDMC = 1
	WMC = 100 (Window)	WMC = 010 ^[1] (Timeout)	WMC = 001 (Autonomous)	WMC = 001 ^[2] (Autonomous)
Normal mode	Window	Timeout	Timeout	off
Standby mode (INTN1 HIGH)	Timeout	Timeout	off	off
Standby mode (INTN1 LOW)	Timeout	Timeout	Timeout	off
Sleep mode	Timeout	Timeout	off	off
Forced Normal mode	off	off	off	off
Other modes	off	off	off	off

[1] Default value if SDMC = 0

[2] Default value if SDMC = 1

Table 9. SBC configuration control register (address 74h)

This table is located in non-volatile memory with restricted write access.

Bit	Symbol	Access	Value	Description
7:6	reserved	R	-	
5:4	V1RTSUC	R/W		V1 reset threshold (defined by bit V1RTC) at start-up:
			00 ^[1]	V1 undervoltage detection at 90 % of nominal value at start-up (V1RTC = 00)
			01	V1 undervoltage detection at 80 % of nominal value at start-up (V1RTC = 01)
			10	V1 undervoltage detection at 70 % of nominal value at start-up (V1RTC = 10)
			11	V1 undervoltage detection at 60 % of nominal value at start-up (V1RTC = 11)
3	FNMC	R/W	0	Forced Normal mode disabled
			1 ^[1]	Forced Normal mode enabled
2	SDMC	R/W	0 ^[1]	Software development mode disabled
			1	Software development mode enabled
1	VEXTAC	R/W	0 ^[1]	regulator V2 can be used as a sensor supply via pin VEXT, provided pin V2 is left floating
			1	regulator V2 not protected against shorts to higher voltages; pin V2 must be shorted to pin VEXT
0	SLPC	R/W	0 ^[1]	Sleep mode supported
			1	Sleep mode not supported

[1] Factory preset value.

Table 10. Watchdog status register (address 05h)

Bit	Symbol	Access	Value	Description
7:4	reserved	R	-	
3	FNMS	R	0	SBC is not in Forced Normal mode
			1	SBC is in Forced Normal mode
2	SDMS	R	0	SBC is not in Software Development mode
			1	SBC is in Software Development mode
1:0	WDS	R		watchdog status:
			00	watchdog is off
			01	watchdog is in first half of window
			10	watchdog is in second half of window
			11	reserved

7.2.1 Software development mode

Software Development mode is provided to simplify the software design process. When Software Development mode is enabled, the watchdog starts up in Autonomous mode (WMC = 001) and is inactive after a system reset, overriding the default value (see [Table 7](#)). The watchdog is always off in Autonomous mode if Software Development mode is enabled (SDMC = 1; see [Table 9](#)).

Software can be run without a watchdog in Software Development mode. However, it is possible to activate and deactivate the watchdog for test purposes by selecting Window or Timeout mode via bits WMC while the SBC is in Standby mode (note that Window mode will only be activated once the SBC switches to Normal mode). Software Development mode is activated via bits SDMC in non-volatile memory (see [Table 9](#)).

7.2.2 Watchdog behavior in Window mode

The watchdog runs continuously in Window mode. The watchdog is in Window mode when WMC = 100 and the UJA113x is in Normal mode.

In Window mode, the watchdog can only be triggered during the second half of the watchdog period. If the watchdog overflows, or is triggered in the first half of the watchdog period (before $t_{\text{trig(wd)1}}$), a system reset is performed. If the watchdog is triggered in the second half of the watchdog period (after $t_{\text{trig(wd)1}}$ but before $t_{\text{trig(wd)2}}$), the watchdog timer is restarted.

7.2.3 Watchdog behavior in Timeout mode

The watchdog runs continuously in Timeout mode. The watchdog is in Timeout mode when WMC = 010 and the UJA113x is in Normal, Standby or Sleep mode. The watchdog will also be in Timeout mode if WMC = 100 and the UJA113x is in Standby or Sleep mode. If Autonomous mode is selected (WMC = 001), the watchdog will be in Timeout mode if one of the conditions for Timeout mode listed in [Table 8](#) has been satisfied.

In Timeout mode, the watchdog can be triggered at any time up to $t_{\text{trig(wd)2}}$ after the start of the watchdog period. If the watchdog overflows ($t > t_{\text{trig(wd)2}}$), the watchdog interrupt bit (WDI) in the System interrupt status register ([Table 58](#)) is set. If a WDI is already pending, a system reset is performed. In Timeout mode, the watchdog can be used as a cyclic wake-up source for the microcontroller when the UJA113x is in Standby or Sleep mode. In Sleep mode, a watchdog overflow generates a wake-up event.

7.2.4 Watchdog behavior in Autonomous mode

Autonomous mode is selected when WMC = 001. In Autonomous mode, the watchdog is either off or in Timeout mode, according to the conditions detailed in [Table 8](#).

When Autonomous mode is selected, the watchdog will be in Timeout mode if the SBC is in Normal mode and Software Development mode is disabled (SDMC = 0). If the SBC is in Standby mode, the watchdog will be in Timeout mode if INTN1 is LOW and SDMC = 0. Otherwise the watchdog will be off.

7.2.5 Exceptional behavior of the watchdog after writing to the Watchdog register

A successful write operation to the Watchdog control register resets the watchdog timer. Bits WDS are set to 01 and the watchdog restarts at the beginning of the watchdog period (regardless of the selected watchdog mode). However, the watchdog may restart unexpectedly in the second half of the watchdog period or a WDI interrupt may be generated under the following conditions.

Case A: When the watchdog is running in Timeout mode (see [Table 8](#)) and a new watchdog period is selected (via bits NWP) that is shorter than the existing watchdog period, one of both of the following events may occur.

Status bits WDS can be set to 10. When this happens, the timer restarts at the beginning of the second half of the watchdog period, causing the watchdog to overflow earlier than expected. This can be avoided by writing the new NWP (or NWP + WMC) code twice whenever the watchdog period needs to be changed. The write commands should be sent consecutively. The gap between the commands should be at least $t_{d(W)SPI}$, but less than half of the new watchdog period.

If the watchdog is in the second half of the watchdog period when the watchdog period is changed, the timer will be reset correctly. The watchdog will restart at the beginning of the watchdog period and WDS will be set 01. However, a WDI interrupt may be generated unexpectedly. To counteract this effect, the WDI interrupt should be cleared by default after the new watchdog period has been selected. The gap between this command and the two write commands discussed above should not be less than $t_{d(W)SPI}$.

Case B: If the watchdog is triggered in Timeout mode (see [Table 8](#)) at exactly the same time that WDS is set to 10, it will start up again in the second half of the watchdog period. As in Case A, this will cause the watchdog to overflow earlier than expected. This behavior appears identical to an ignored watchdog trigger event and can be avoided by issuing two consecutive watchdog commands. The gap between the commands should be at least $t_{d(W)SPI}$ and the second command should be issued before the end of the first half of the watchdog period. It is recommended to use this trigger scheme if it is possible that the watchdog could be triggered exactly in the middle of the watchdog window.

7.3 System reset

When a system reset occurs, the SBC switches to Reset mode and initiates a process that generates a low-level pulse on pin RSTN.

When the UJA113x enters Reset mode, the value stored in the reset counter (RCC) is checked. If $RCC < 3$, the reset counter is incremented (bits $RCC = RCC + 1$; see [Table 12](#)). Pin RSTN is then pulled LOW for the selected reset length ($t_{w(rst)}$) to begin the reset process. The reset length is determined by bits RLC in the Start-up control register ([Table 11](#)). When the reset timer expires, RSTN is released and the SBC switches to Standby mode.



Fig 5. Reset process during a system reset

The reset counter ensures that repeated reset events are detected. If RCC is equal to 3 when the UJA113x enters Reset mode, the SBC assumes that a serious failure has occurred and switches to FSP mode, enabling the limp home function (see [Section 7.5](#)).

When the system is running correctly, it is expected that the reset counter will be reset (RCC = 00) periodically by the system software to ensure that routine reset events do not cause it to overflow. When the battery supply voltage is low ($V_{BATSMPS} < V_{Uvd}(BATSMPS)$), the reset counter is not incremented. This precaution ensures that the system starts up properly when the supply voltage is low.

The voltage on V1 is monitored throughout the reset process. If a V1 undervoltage is detected, the reset timer is restarted. The reset process is also monitored by a reset time-out timer. The reset time-out timer ensures that deadlock is avoided in Reset mode, e.g. due to a permanently low V1 supply. If the reset process has not been completed by the time the reset time-out timer expires (after $t_{to(rst)}$), the reset counter is incremented. The reset process is then restarted if $RCC < 3$. If $RCC = 3$, the SBC switches to FSP mode.

7.3.1 Characteristics of pin RSTN

Pin RSTN is a bidirectional open-drain low-side driver with integrated pull-up resistance, as shown in Figure 6. With this configuration, the SBC can detect the pin being pulled down externally, e.g. by the microcontroller. The input reset pulse width must be at least $t_{w(rst)}$.

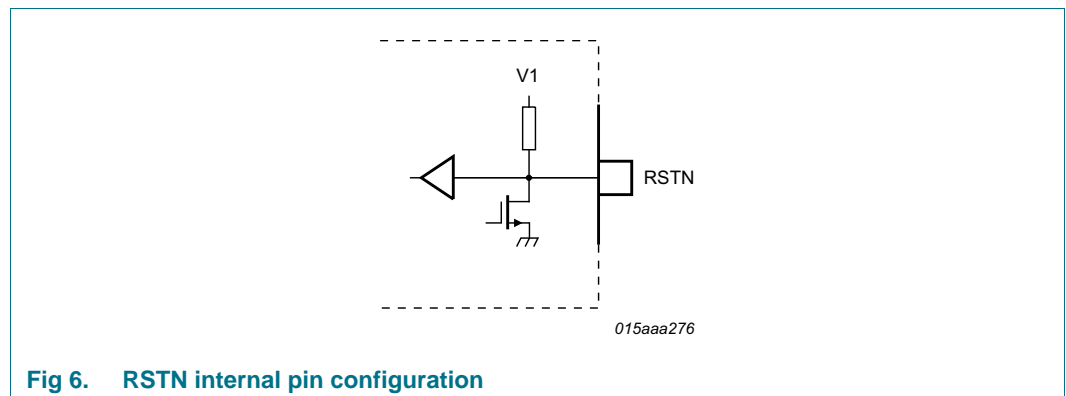

Fig 6. RSTN internal pin configuration

7.3.2 Selecting the output reset pulse width

The duration of the output reset pulse is selected via bits RLC in the Start-up control register (Table 11), which is located in non-volatile memory. The SBC distinguishes between a cold start and a warm start. A cold start is performed on start-up if the reset event was generated by a V1 undervoltage event (the V1 undervoltage threshold is defined by bits V1RTC; see Table 25). This happens when the SBC exits Off, Overload and Sleep modes. The output reset pulse width for a cold start is determined by the setting of bits RLC.

If the reset event was not triggered by a V1 undervoltage (e.g. by a warm start of the microcontroller), the SBC always uses the shortest reset length ($t_{w(rst)} = 1 \text{ ms to } 1.5 \text{ ms}$).

Table 11. Start-up control register (address 73h)

This table is located in non-volatile memory with restricted write access.

Bit	Symbol	Access	Value	Description
7:6	reserved	R	-	
5:4	RLC	R/W		RSTN output reset pulse width:
			00 ^[1]	$t_{w(\text{rst})} = 20 \text{ ms to } 25 \text{ ms}$
			01	$t_{w(\text{rst})} = 10 \text{ ms to } 12.5 \text{ ms}$
			10	$t_{w(\text{rst})} = 3.6 \text{ ms to } 5 \text{ ms}$
			11	$t_{w(\text{rst})} = 1 \text{ ms to } 1.5 \text{ ms}$
3	V2SUC	R/W		V2 start-up control:
			0 ^[1]	bits V2C set to 00 at power-up (default)
			1	bits V2C set to 11 at power-up
2	IO4SFC	R/W		HVIO4 configuration control:
			0 ^[1]	pin HVIO4 configured as a standard I/O pin
			1	HVIO4 limp home function enabled
1	IO3SFC	R/W		HVIO3 configuration control:
			0 ^[1]	pin HVIO3 configured as a standard I/O pin
			1	HVIO3 limp home function enabled
0	IO2SFC	R/W		HVIO2 configuration control:
			0 ^[1]	pin HVIO2 configured as a standard I/O pin
			1	HVIO2 limp home function enabled

[1] Factory preset value.

7.3.3 Reset sources

The following events cause the SBC to switch to Reset mode:

- V_{V1} drops below the selected V1 undervoltage threshold defined by bits V1RTC
- pin RSTN is pulled down externally
- the watchdog overflows in Window mode
- the watchdog is triggered too early in Window mode (before $t_{\text{trig}(\text{wd})1}$)
- the watchdog overflows in Timeout mode while a watchdog interrupt (WDI) is pending
- an attempt is made to reconfigure the Watchdog control register while the SBC is in Normal mode
- the SBC leaves Off mode
- the SBC leaves Overload mode
- the SBC leaves Sleep mode (local or bus wake-up)
- a Sleep mode command is received while an interrupt is pending (INTN1 LOW; see [Section 7.12.3](#))
- a Sleep mode command is received while no regular interrupt is selected (see [Section 7.12.3](#))

7.4 EN output

The EN pin can be used to control external hardware, such as power components, or as a general-purpose output when the system is running properly.

The EN pin is a V1-based digital output driver. It can be configured via bit ENDC in the Fail-safe control register as a push-pull output driver or as an open-drain low side driver. The functionality is identical in both configurations. The only difference is that the pin is left floating if the open-drain option is selected and pulled up otherwise.

The output signal on pin EN is configured via bit ENC as follows:

- ENC = 00: EN is permanently LOW
- ENC = 01: EN is HIGH when the SBC is in Normal, Reset and Standby modes
- ENC = 10: EN is HIGH when the SBC is in Normal mode
- ENC = 11: EN is controlled by Timer 2

If the high-side driver is deactivated (ENDC = 1), a pull-up resistor is needed from EN to V1, regardless of the value of ENC.

The EN pin can be used to deactivate external hardware in the event of a battery over- or undervoltage when the SBC is in Normal mode (see also [Section 7.8.2](#)). This function is enabled/disabled via bits ENSC (see [Table 12](#)). When this function is enabled, the EN pin is driven low when the battery supply is outside its specified operating range (see [Table 12](#)). When this happens, the settings of bits ENC are ignored.

7.4.1 Fail-safe control register

The Fail-safe control register contains the reset counter along with EN and limp home control settings.

Table 12. Fail-safe control register (address 02h)

Bit	Symbol	Access	Value	Description
7:6	ENSC	R/W		EN shut-down control:
			00	EN pin not influenced by battery over- or undervoltage
			01	EN pin driven LOW when battery undervoltage detected
			10	EN pin driven LOW when battery overvoltage detected
			11	EN pin driven LOW when battery over- or undervoltage detected
5	ENDC	R/W		EN high-side driver activation:
			0	EN high-side driver enabled; push-pull output
			1	EN high-side driver disabled; pin configured as an open-drain low-side driver
4:3	ENC	R/W		EN output configuration:
			00	EN is driven permanently LOW
			01	EN is HIGH (or floating if ENDC = 1) when the SBC is in Normal, Reset and Standby modes
			10	EN is HIGH (or floating if ENDC = 1) when the SBC is in Normal mode
			11	EN is controlled by Timer 2

Table 12. Fail-safe control register (address 02h) ...continued

Bit	Symbol	Access	Value	Description
2	LHC	R/W		LIMP output configuration:
			0	LIMP pin is floating
			1	LIMP pin is driven LOW
1:0	RCC	R/W	xx	reset counter; incremented at every system reset if $V_{BATSMPS} > V_{UVD}(BATSMPS)$; maximum value is 3

7.5 Limp home function

The LIMP pin can be used to enable so called 'limp home' hardware in the event of an ECU failure. Detectable failure conditions include SBC overtemperature events, loss of watchdog service, short circuits on pins RSTN or V1 and user-initiated or external reset events. The LIMP pin is a battery-related, active-LOW, open-drain output.

The LIMP pin is activated automatically (via bit LHC in the Fail-Safe control register; [Table 12](#)) as the soon as the SBC enters Overload Mode or switches to FSP mode after multiple reset events. Alternatively, the host controller can activate the LIMP output directly by setting bit LHC via the SPI.

Bit LHC is cleared automatically when the SBC enters Off mode. In SBC active modes, it is assumed that the host controller will clear bit LHC via the SPI. When bit LHC is cleared, the LIMP pin is immediately released.

In addition to the LIMP pin, an advanced limp home function has been implemented via pins HVIO2, HVIO3 and HVIO4 (see [Section 7.10.6](#)). These pins can be configured individually as 'limp home' or standard I/O pins via the Start-up control register (see [Table 11](#)), which is located in the non-volatile memory area.

Pin HVIO2 can be used as an additional static LIMP signal. The difference between this pin and the LIMP pin is that HVIO2 activates its high-side driver to allow the dedicated limp home hardware to be supplied directly.

The high-side driver of HVIO3 can be used to drive a PWM signal with a 10 % duty cycle and a period of 100 Hz when configured as a limp home output. HVIO4 provides a slow 1.25 Hz clock with a 50 % duty cycle that can be used for hazard light control.

7.6 Global temperature protection

The temperature of the UJA113x is monitored continuously. The SBC switches to Overload mode when the global chip temperature rises above the overtemperature protection activation threshold, $T_{th(act)otp}$. When this event happens, pin RSTN is driven LOW and limp home is activated (pin LIMP is driven low; HVIO2/HVIO3/HVIO4 limp home functionality is triggered if enabled). In addition, the SMPS, the CAN and LIN transceivers and all voltage regulators are switched off. The HVIO pins are set to fail-safe state (see [Section 7.10.4](#)). When the global chip temperature falls below the overtemperature protection release threshold, $T_{th(rel)otp}$, the SBC switches to Standby mode via Reset mode.

The SBC can be configured to issue an overtemperature warning. When the global chip temperature rises above the overtemperature warning threshold ($T_{th(warn)otp}$), the SBC generates an OTWI interrupt, if enabled. It can also lower the output voltage of the SMPS to reduce power dissipation (see [Section 7.8.4.6](#)).

7.7 Register locking

Sections of the register address map can be write-protected to protect against unintended modifications. Any attempt to overwrite a locked register results in the entire SPI command being ignored (even if part of the SPI command accesses unlocked registers). An SPI failure interrupt is generated (SPIFI = 1), if enabled. Note that this facility only protects locked bits from being modified via the SPI and will not prevent the UJA113x updating status registers etc.

Table 13. Lock control register (address 0Ah)

Bit	Symbol	Access	Value	Description
7	reserved	R	-	
6	LK6C	R/W		lock control 6: address area 0x68 to 0x6F - data mask (FD versions only)
			0	SPI write-access enabled
			1	SPI write-access disabled
5	LK5C	R/W		lock control 5: address area 0x50 to 0x5F - Timer control
			0	SPI write access enabled
			1	SPI write access disabled
4	LK4C	R/W		lock control 4: address area 0x40 to 0x4F - HVIO5 to HVIO8 control (if HVIO bank 1 available; see Section 7.10)
			0	SPI write access enabled
			1	SPI write access disabled
3	LK3C	R/W		lock control 3: address area 0x30 to 0x3F - HVIO1 to HVIO4 control (if HVIO bank 0 available; see Section 7.10)
			0	SPI write access enabled
			1	SPI write access disabled
2	LK2C	R/W		lock control 2: address area 0x20 to 0x2F - transceiver control
			0	SPI write access enabled
			1	SPI write access disabled
1	LK1C	R/W		lock control 1: address area 0x10 to 0x1F - supply control
			0	SPI write access enabled
			1	SPI write access disabled
0	LK0C	R/W		lock control 0: address area 0x06 to 0x09 - general-purpose memory
			0	SPI write access enabled
			1	SPI write access disabled

7.8 Power supplies

7.8.1 Battery supply pins

The UJA113x contains a number of supply pins for supplying different SBC modules:

- BATSMPS supplies the SMPS and regulator V1
- BATV2 supplies regulator V2
- BATHS1 supplies HVIO1, HVIO2, HVIO3 and HVIO4 (if available)
- BATHS2 supplies HVIO5, HVIO6, HVIO7 and HVIO8 (if available)
- BAT supplies the LIN transceiver and is an input to the A/D converters

An external diode is needed in series between the battery and any supply pin connected directly to the battery to protect the device against negative voltages. The battery pins can be supplied via different paths. A loss of supply at one or more of the battery pins will not damage the device.

The internal circuitry is supplied via pin BAT or pin VSMPS. If both V_{BAT} and V_{VSMPS} fall below the power-off detection threshold, $V_{th(det)pooff}$, the SBC switches immediately to Off mode. The voltage regulators and the internal logic are shut down in Off mode. The SBC switches from Off mode to Standby mode as soon as V_{BAT} rises above the power-on detection threshold, $V_{th(det)pon}$. This event generates a power-on status interrupt (POSI) to inform the microcontroller that the UJA113x has left Off mode.

7.8.2 Battery monitor

The SBC contains a two-channel 10-bit ADC covering the 20 V full-scale range for monitoring the battery voltage. The ADC is used to measure the supply voltages on pins BAT and BATSENSE. If a series resistor and a capacitor are connected as shown in [Figure 7](#), the supply voltage connected to the anode of the reverse polarity diode can be monitored via pin BATSENSE. The ADC conversion results are stored in bits BMBCD and BMSCD in, respectively, the V_{BAT} and $V_{BATSENSE}$ conversion results registers ([Table 18/Table 19](#) and [Table 20/Table 21](#)).

An under- or overvoltage event on a selected ADC channel generates a battery monitor undervoltage (BMUI) or overvoltage (BMOI) interrupt (and optionally deactivates the CAN transceiver and peripheral loads connected to HVIO_n/V2/VEXT or EN). The channel is selected via the battery monitor source control bit (BMSC) in the Battery monitor trigger source control register ([Table 14](#)). If BMSC = 0, an under- or overvoltage on pin BAT triggers an interrupt. If BMSC = 1, an under- or overvoltage on pin BATSENSE triggers an interrupt.

The battery monitor under- and overvoltage thresholds are set via bits BMUTC and BMOTC (see [Table 15](#) and [Table 16](#)). Under- and overvoltage threshold hysteresis levels are set via bits BMHUC and BMHOC (see [Table 17](#)). The under- and overvoltage status can be monitored via bits BMUVS and BMOVS in the Supply status register ([Table 22](#)).

In order to minimize quiescent current consumption, battery monitoring is only enabled when the SBC is in Normal mode. When battery monitoring is deactivated, all related functions are unavailable.



Fig 7. Battery monitoring circuit

Table 14. Battery monitor event trigger source control register (address 11h)

Bit	Symbol	Access	Value	Description
7:1	reserved	R	-	
0	BMSC	R/W		trigger source for generating battery monitoring/overvoltage/undervoltage/shutdown events:
			0	voltage on BAT triggers an event
			1	voltage on BATSENSE triggers an event

Table 15. Battery monitor undervoltage threshold control register (address 12h)

Bit	Symbol	Access	Value	Description
7:0	BMUTC	R/W	xxxxxxx	threshold for triggering a battery undervoltage event and BMUI interrupt; threshold = $BMUTC[7:0]/255 \times 20 \text{ V}$

Table 16. Battery monitor overvoltage threshold control register (address 13h)

Bit	Symbol	Access	Value	Description
7:0	BMOTC	R/W	xxxxxxx	threshold for triggering a battery overvoltage event and BMOI interrupt; threshold = $BMOTC[7:0]/255 \times 20 \text{ V}$

Table 17. Battery monitor hysteresis control register (address 14h)

Bit	Symbol	Access	Value	Description
7:4	BMHOC	R/W	xxxx	battery monitor overvoltage threshold release level; release level = $BMHOC[7:4] \times 4/255 \times 20 \text{ V}$ below threshold defined by BMOTC
3:0	BMHUC	R/W	xxxx	battery monitor undervoltage threshold release level; release level = $BMHUC[3:0] \times 4/255 \times 20 \text{ V}$ below threshold defined by BMUTC

Table 18. ADC conversion results for V_{BAT} register 1 (address 15h)

Bit	Symbol	Access	Value	Description
7:0	BMBCD	R	xxxxxxx	ADC conversion results for voltage measured on pin BAT; 8 most significant bits

Table 19. ADC conversion results for V_{BAT} register 2 (address 16h)

Bit	Symbol	Access	Value	Description
7:3	reserved	R	-	
2	BMBCS			ADC conversion results for V _{BAT} read out via SPI:
			0	8 MSBs of BMBCD not read out via SPI
			1	8 MSBs of BMBCD read out via SPI
1:0	BMBCD	R	xx	ADC conversion results for voltage measured on pin BAT; 2 least significant bits

Table 20. ADC conversion results for V_{BATSENSE} register 1 (address 17h)

Bit	Symbol	Access	Value	Description
7:0	BMSCD	R	xxxxxxxx	ADC conversion results for voltage measured on pin BATSENSE; 8 most significant bits

Table 21. ADC conversion results for V_{BATSENSE} register 2 (address 18h)

Bit	Symbol	Access	Value	Description
7:3	reserved	R	-	
2	BMSCS			ADC conversion results for V _{BATSENSE} read out via SPI:
			0	8 MSBs of BMSCD not read out via SPI
			1	8 MSBs of BMSCD read out via SPI
1:0	BMSCD	R	xx	ADC conversion results for voltage measured on pin BATSENSE; 2 least significant bits

Table 22. Supply voltage status register (address 1Bh)

Bit	Symbol	Access	Value	Description
7:6	reserved	R	-	
5	BMOVS	R		overvoltage status of voltage on selected (via BMSC) event trigger source (BAT or BATSENSE):
			0	voltage below overvoltage threshold (defined by BMOTC)
			1	voltage above overvoltage threshold (defined by BMOTC)
4	BMUVS	R		undervoltage status of voltage on selected (via BMSC) event trigger source (BAT or BATSENSE):
			0	voltage above undervoltage threshold (defined by BMUTC)
			1	voltage below undervoltage threshold (defined by BMUTC)
3	SMPSS	R		status of voltage on pin VSMPs:
			0	V _{VSMPs} is within the regulation window
			1	V _{VSMPs} is outside the regulation window
2:1	VEXTS	R		status of VEXT pin:
			00	V _{VEXT} ok (above undervoltage and below overvoltage thresholds)
			01	V _{VEXT} below undervoltage threshold
			10	V _{VEXT} above overvoltage threshold
			11	V _{VEXT} disabled

Table 22. Supply voltage status register (address 1Bh) ...continued

Bit	Symbol	Access	Value	Description
0	V1S	R		V1 status:
			0	V1 output voltage above 90 % undervoltage threshold
			1	V1 output voltage below 90 % undervoltage threshold

7.8.3 Overvoltage shut-down

If the supply voltage remains above the overvoltage detection threshold ($V_{th(det)ov}$) for longer than $t_{det(ov)}$, the SBC triggers an Overvoltage shut-down interrupt (OVSDI; see [Table 56](#)). Once the interrupt has been generated, the overvoltage shut-down timer is started and the SBC enters Overload mode after $t_{d(sd)ov}$.

If the supply voltage falls below the overvoltage release threshold ($V_{th(rel)ov}$) while the overvoltage shut-down timer is running, a system reset is generated when the timer expires and the SBC switches to Standby mode (via Reset mode; see [Figure 4](#)).

A system reset is generated every time the SBC exits Overload mode. In all cases, the reset source is recorded as 'leaving Overload mode' (RSS = 10010; see [Table 6](#)).

7.8.4 Buck and Boost converter (SMPS)

All the active components of a SMPS are included in the UJA113x (only a single external coil and some capacitors are needed to obtain a functional SMPS). Three bootstrap capacitors are needed between pins CAPA and CAPB, BOOTH1 and L1 and between BOOTH2 and L2 (see [Figure 31](#)). The converter operating mode, Boost or Buck is selected automatically and depends on the supply voltage level and the load conditions. The SMPS configuration is shown in [Figure 8](#).

The SMPS is used as a pre-regulator for linear regulator V1. It can also be used as a pre-regulator for V2 or to supply an external load such as an LED chain.

7.8.4.1 SMPS parameter selection and status monitoring

The SMPS output voltage (between 5 V and 8 V) is selected via bits SMPSOC in the SMPS output voltage control register ([Table 24](#)). Since the SMPS is intended to operate as a pre-regulator for linear regulators V1 and/or V2, the output voltage must be set to a voltage higher than the output voltage(s) of V1 and/or V2. At power-on and when a pulse is detected on RSTN, the SMPS is enabled with the output voltage set to 6.0 V (the default value; see [Table 87](#)).

The SMPS status can be monitored via bit SMPSS in the Supply voltage status register ([Table 22](#)). A regulation window is defined from $V_{VSMPs(act)} - 60 \text{ mV}$ to $V_{VSMPs(act)} + 60 \text{ mV}$. $V_{VSMPs(act)}$ is the actual value of the SMPS output voltage at DC load. SMPSS is set to 0 when V_{VSMPs} is within the regulation window. SMPSS is set to 1 when V_{VSMPs} is outside the regulation window for longer than $t_{to(reg)}$. This time-out is added because load transients may cause a short excursion of V_{vsmps} outside the 60 mV window while the SMPS is still in regulation and inside its specified limits. An SMPSSI interrupt is generated, if enabled (SMPSSIE = 1; see [Table 66](#)), when V_{VSMPs} moves outside the regulation window.

The SMPSS flag will be set/cleared when V_{vsmps} leaves/enters the regulation window because of a transition between switched mode and Pass-through mode. This includes transitions requested via SPI, automatic transitions caused by a too-low or too-high supply

voltage, and automatic transitions caused by a too-high output current. The SMPSS flag is disabled when the SMPS is in Pass-through mode and cannot trigger an SMPSSI interrupt.

Table 23. SMPS control register (address 19h)

Bit	Symbol	Access	Value	Description
7:4	reserved	R	-	
3	SMPSOTC	R/W		SMPS overtemperature control:
			0	V_{VSMPS} not modified when an overtemperature warning received (OTWI interrupt)
			1	V_{VSMPS} automatically reduced to 5 V when the chip temperature is above the overtemperature warning threshold, $T_{th(warn)otp}$
2	reserved	R	-	
1:0	SMPSC	R/W		SMPS on/off control:
			00	the SMPS is on in Normal, Standby and Reset modes and shut down in all other modes
			01	the SMPS is on in Normal, Standby, Reset and Sleep modes and shut down in all other modes
			10	reserved
			11	Pass-through mode is requested in Normal, Standby and Sleep modes

Table 24. SMPS output voltage control register (address 1Ah)

Bit	Symbol	Access	Value	Description
7:4	reserved	R	-	
3:0	SMPSOC	R/W		SMPS output voltage (V_{VSMPS}):
			0000	5.0 V
			0001	5.2 V
			0010	5.4 V
			0011	5.6 V
			0100	5.8 V
			0101	6.0 V
			0110	6.2 V
			0111	6.4 V
			1000	6.6 V
			1001	6.8 V
			1010	7.0 V
			1011	7.2 V
			1100	7.4 V
1101	7.6 V			
1110	7.8 V			
1111	8.0 V			

7.8.4.2 Automatic up/down principle

An up- and a down-converter are combined in the SMPS. The SMPS switches automatically and seamlessly between three operating modes, without affecting the performance.

Buck mode: The converter will be in Buck mode when the required output voltage is significantly lower than the input voltage. In this mode, the coil terminal connected to pin L2 is permanently connected to the output, VSMPS, via internal switch S3 (see Figure 8). S1 and S2 are the buck converter switches.

A buck converter uses significantly less energy than a linear regulator because the average input current is lower than the average output current.

Boost mode: The converter will be in Boost mode when the required output voltage is higher than the input voltage. In this mode, the coil terminal connected to pin L1 is permanently connected to the input, pin BATSMPS, via internal switch S1. S3 and S4 are the boost converter switches. In Boost mode, the average input current is higher than the average output current.

At very low input voltages, the load can be too great to maintain a constant output voltage, causing the output voltage to fall. Note that the boost current capability of the UJA1131/UJA1132 is higher than that of the UJA1135/UJA1136.

Auto mode: The converter will be in Auto mode when the required output voltage is in the same range as the input voltage. In this mode, all four switches operate to maintain the output voltage at the correct level, independently of the input voltage.



Fig 8. Configuring the automatic Buck and Boost mode controller

Bootstrap cycle: In Buck, Boost and Auto modes, a bootstrap capacitor charge cycle is inserted after every 32nd PWM cycle. The duration of the charge cycle is 1/4 of a PWM cycle. During the bootstrap charge cycle, both sides of the coil are connected to ground.

In Pass-through mode (see [Section 7.8.4.4](#)), a bootstrap charge cycle only occurs if one of the bootstrap voltages drops below the minimum voltage required to keep S1 and S3 switched on properly. The bootstrap charge cycle frequency is automatically reduced to minimize quiescent current.

7.8.4.3 Start-up and inrush currents

The SMPS can start up at any battery voltage above the power-on level. It switches automatically to Boost, Buck or Auto mode as required by the battery voltage level and output voltage setting. The auto up/down mechanism allows for a controlled start-up, even when the input voltage is lower than the desired output voltage. Unlike a conventional boost-converter, the SMPS does not require a voltage at the output to start up.

To avoid excessive inrush currents and coil saturation at start-up, the rate of increase of the coil current is limited by the switching control mechanism when the SMPS is starting up. This function also prevents overshoot at the output voltage during start-up.

7.8.4.4 Pass-through mode operation

When the output load is light, it may not be necessary to use the SMPS as a pre-regulator for V1 and/or V2 since the internal power dissipation will be relatively low, even when using linear regulators. For example, the microcontroller still needs to be supplied when the SBC is in Standby mode, even though it may be switched to a low-current mode. Pass-through mode is provided for such situations.

In Pass-through mode, switches S1 and S3 are closed. The internal power consumption of the SMPS is negligible. The output voltage mirrors the input voltage, less the voltage drop across the coil and the switches.

Pass-through mode is selected via bits SMPSC in the SMPS control register ([Table 23](#)). When SMPSC is set to 11, the UJA113x switches to Pass-through mode provided no over- or under-voltage is detected and the load current is below the pass-through overcurrent threshold, $I_{th(ocd)(VSMPS)}$. The transition from a switching mode to Pass-through mode is made gradually to avoid overshoots and oscillations on VSMPS (see [Section 7.8.4.5](#)).

Pass-through mode is automatically disabled and the SMPS is reactivated under any of the following conditions:

- undervoltage detected ($V_{BATSMPS} < V_{uvd}(BATSMPS)$)
- overvoltage detected ($V_{BATSMPS} > V_{ovd}(BATSMPS)$)
- the chip temperature rises above the overtemperature warning threshold ($T_{th(warn)otp}$)
- the load current exceeds the pass-through overcurrent threshold, $I_{th(ocd)(VSMPS)}$

Undervoltage protection prevents a system reset being generated by a falling battery supply voltage. Overvoltage protection ensures that loads connected to the SMPS output are not exposed to the high voltages that could be generated during a jump start or load dump. Overvoltage protection also allows 16 V ceramic capacitors to be used at the SMPS output.

When the chip temperature exceeds the overtemperature warning threshold, the SMPS is reactivated to reduce internal dissipation. If the load current exceeds the pass-through overcurrent threshold, $I_{th(ocd)(VSMPS)}$, the SMPS is reactivated to limit the output current in the event of a short-circuit condition on the VSMPS pin.

A timer is started as soon as the SMPS is activated. If the condition that caused the SMPS to leave Pass-through mode is removed before the timer expires (after $t_{d(act)}$), the return to Pass-through mode is postponed until the timer has expired ($t_{d(act)}$ is the minimum time the SMPS spends in switched mode before a transition to Pass-through mode can be attempted).

When the SMPS is active, it is not possible to determine if an overcurrent would be detected in Pass-through mode. So the SMPS will attempt to return to Pass-through mode after $t_{d(act)}$ if Pass-through mode is still selected (SMPSC = 11) and no over- or under-voltage is present. If an overcurrent is detected, the SMPS will be activated again (after $t_{t(sw-pt)}$). So a continuous overcurrent causes the SMPS to cycle through active and Pass-through modes with a period of $t_{d(act)} + t_{t(sw-pt)}$.

Automatic transition in and out of Pass-through mode is illustrated in [Figure 9](#).

During the transition from Pass-through to an active SMPS operating mode, the voltage on the VSMPS pin remains above the selected output voltage. This precaution guarantees that the voltage regulator(s) remains in regulation and within specification. It also ensures that the system can withstand load current transients on the V1 regulator output from 0 mA to 500 mA in Standby mode.



7.8.4.5 Transitions to and from Pass-through mode

When switching to Pass-through mode, the SMPS cannot simply close the two high-side switches (S1 and S3) as this would generate very large transient currents in the coil and a large output voltage overshoot. Instead, the SMPS controller slowly increase the duty

cycle. As soon as the controller detects a 100% duty cycle it stops switching and only generates filling pulses to keep the bootstrap capacitors charged. The time required to reach 100% duty cycle depends on the output load. The transition is always completed within $t_{t(sw-pt)}$. This behavior is illustrated in [Figure 10](#).



After the fixed transition time ($t_{t(sw-pt)}$), all analog modules involved in SMPS switching are switched off to conserve current. The pass-through control module will remain active to provide regular filler pulses to keep the bootstrap supply capacitors charged. It will also monitor the over- and under voltage indicator signals. The SMPS will meet Standby mode current requirements.

The transition time is inserted to allow the system (microcontroller) some time to switch to a sleep mode after switching on Pass-through mode.

When the SMPS is triggered to leave Pass-through mode, V_{VSMPS} is likely to be much greater than the programmed value. To achieve a smooth transition, all analog circuits are started up and all switching is suspended. This will cause V_{VSMPS} to fall. Once V_{VSMPS} falls below the programmed output voltage level plus 100 mV, normal switching is resumed. The time between disabling Pass-through mode and the SMPS starting switching is determined by the output load.

To prevent the SMPS rapidly oscillating between switching and Pass-through mode, it will remain in switching mode for at least $t_{d(act)}$ before attempting to return to Pass-through mode.



7.8.4.6 Overload protection

Output current limiting protects the SMPS and the control module against short circuits at the output.

Under normal operating conditions, the SMPS minimizes internal power dissipation. However, if the input voltage is low when the SMPS is required to supply a heavy load in Boost mode, the input current can significantly exceed the output current. When this happens, the power dissipated in the internal switches and diodes can lead to thermal overload. Thermal shutdown can be avoided by reducing the load current and/or the SMPS output voltage. An overtemperature warning (status bit OTWS = 1; see [Table 6](#)) can be interpreted as a request to take appropriate action.

The UJA113x provides an option to reduce the SMPS output voltage to 5 V automatically when the overtemperature warning threshold has been exceeded. This option is enabled by setting bit SMPSOTC in the SMPS control register ([Table 23](#)) to 1. When this option is activated, the linear regulators fed by the SMPS are no longer able to supply 5 V. However the output voltage of the regulator supplying the microcontroller may still be high enough for it to remain operational. This depends on the supply voltage range of the microcontroller. Automatic output voltage reduction is disabled (SMPSOTC = 0) at power-up and when a pulse is received on RSTN.

7.8.5 Linear regulators

The UJA113x contains two independent voltage regulators, V1 and V2.

7.8.5.1 V1 regulator

Regulator V1 is intended to supply the microcontroller, its periphery and additional CAN transceivers and delivers up to 500 mA at 3.3 V or 5 V. It is supplied internally from the output of the SMPS.

The output voltage on V1 is monitored continuously. A system reset is generated if the voltage on V1 falls below the undervoltage threshold.

For the 5 V versions of the UJA113x (UJA113x/5V0), the undervoltage threshold (60 %, 70 %, 80 % or 90 % of the nominal V1 voltage) is selected via bits V1RTC in the Regulator control register ([Table 25](#)). The default value of the undervoltage threshold at power-up is determined by the value of bits V1RTSUC in the SBC configuration control register ([Table 9](#)). The SBC configuration control register is in non-volatile memory, allowing the user to define the undervoltage threshold (V1RTC) at start-up.

For the 3.3 V versions (UJA113x/5V0), the 90 % threshold always applies (regardless of the V1RTC and V1RTSUC setting).

In addition, a warning is issued (a V1UI interrupt) if V1 drops below 90 % of the nominal value (provided the interrupt is enabled; V1UIE = 1). The UJA113x/5V0 can use this information to warn the microcontroller that the level on V1 is outside the nominal supply range when the 60 %, 70 % or 80 % threshold is selected. The status of V1, whether the output voltage is above or below the 90 % undervoltage threshold, can be read via bit V1S in the Supply voltage status register ([Table 22](#)).

In reverse supply situations (e.g. when the attached microcontroller is in low-power mode and current is injected via its port pins to its supply pins), internal clamp circuitry ensures that the voltage on pin V1 remains below 6 V.

7.8.5.2 Voltage regulator V2

Voltage regulator V2 is a 5 V regulator with two outputs V2 and VEXT.

If the regulator is intended to supply external components that require protection against shorts to battery and shorts to ground, the VEXT output should be selected, leaving pin V2 open. Bit VEXTAC must be set to 0 (see [Table 9](#)). In this configuration, the output current flows through a transistor connected between V2 and VEXT (see [Figure 1](#)). This transistor is automatically deactivated if an overvoltage is detected at pin VEXT. The transistor is re-enabled when the overvoltage condition is removed, reactivating VEXT.

Pins V2 and VEXT should be shorted together when the regulator is being used to supply internal loads (e.g. the CAN transceiver and other peripheral loads). In this case, bit VEXTAC should be set to 1 (VEXTAC is located in non-volatile memory).

The V2 output pin is not protected against shorts to the battery, but connecting V2 to VEXT reduces the supply voltage needed on BATV2 to generate 5 V at the output at low battery voltages. The configuration options are illustrated in [Figure 12](#).

V2 is enabled and disabled via bits V2C in the Regulator control register (Table 25). The value of bits V2SUC in the Start-up control register (Table 11) determine the default value at power-up. The Start-up control register is in non-volatile memory (see Section 7.13), allowing the user to define the configuration of V2 at start-up.

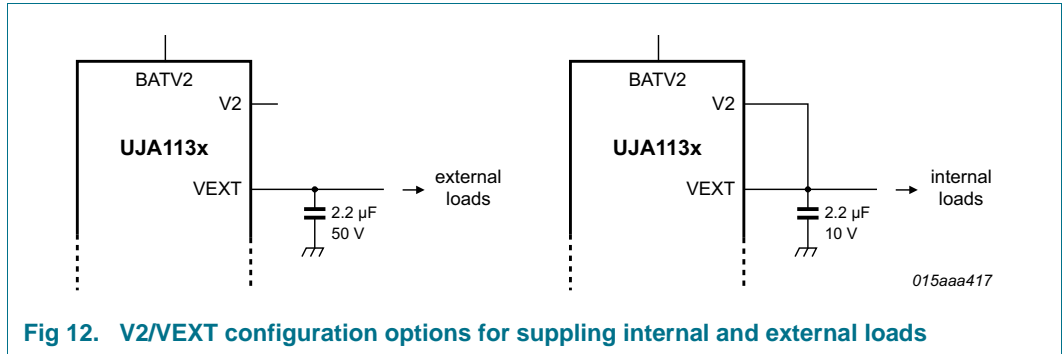

The output voltage on VEXT is monitored continuously. Warnings are issued when the voltage drops below 90 % of the nominal value (VEXTUI interrupt) or rises to 110 % of the nominal value (VEXTOI interrupt). This information can be used to warn the microcontroller that the level on VEXT is outside the nominal supply range or that a failure has occurred. The status of V_{VEXT} can be read via bits VEXTS in the Supply voltage status register (Table 22).

The UJA113x can be configured to shut down V2 automatically when the battery monitor detects an under- or overvoltage on the battery supply (via bits V2SC; see Table 25).

7.8.5.3 Regulator control register

Table 25. Regulator control register (address 10h)

Bit	Symbol	Access	Value	Description
7:6	reserved	R	-	
5:4	V2SC	R/W		V2 shutdown response to a battery over- or undervoltage:
			00	no shut-down in response to under- or overvoltage
			01	shut-down in response to an undervoltage
			10	shut-down in response to an overvoltage
			11	shut-down in response to under- and overvoltage
3:2	V2C	R/W	[1]	V2 control:
			00	V2 off in all modes
			01	V2 on in Normal mode
			10	V2 on in Normal, Standby and Reset modes
			11	V2 on in Normal, Standby, Sleep, Reset and FSP modes
1:0	V1RTC	R/W	[2]	V1 undervoltage reset threshold:
			00	reset threshold set to 90 % of V1 nominal output voltage
			01	reset threshold set to 80 % of V1 nominal output voltage
			10	reset threshold set to 70 % of V1 nominal output voltage
			11	reset threshold set to 60 % of V1 nominal output voltage

[1] Default value at power-up defined by setting of bits V2SUC (see Table 11).

- [2] Valid for the UJA113x/5V0 versions only; for the UJA113x/3V3 versions, the V1 undervoltage reset threshold is always 90 % of the nominal value. Default value at power-up defined by setting of bits V1RTSUC. (see [Table 9](#)).

7.9 CAN and LIN bus transceivers

7.9.1 High-speed CAN transceiver

The integrated high-speed CAN transceiver is designed for active communication at bit rates up to 1 Mbit/s (up to 2 Mbit/s in the CAN FD data field), providing differential transmit and receive capability to a CAN protocol controller. The transceiver is ISO 11898-2:201x (upcoming merged ISO 11898-2/5/6 standard) compliant. It is supplied via pin VCAN, which can be connected to the output of V2, for example, or to V1 in the 5 V version (UJA113x/5V0).

The CAN transceiver supports autonomous CAN biasing. When the SBC detects activity on the CAN-bus, it activates autonomous CAN biasing if the CAN transceiver is inactive. This is useful when the node is disabled due to a malfunction in the microcontroller. The SBC ensures that the CAN-bus is correctly biased so that communication is not disturbed by a disabled ECU. The autonomous CAN bias voltage is derived directly from the battery, so it is active even if VCAN is not supplied.

7.9.1.1 CAN operating modes

The integrated CAN transceiver supports four operating modes: Active, Listen-only, Offline and Offline Bias (see [Figure 13](#)). The CAN transceiver operating mode depends on the UJA113x operating mode and on the setting of bits CMC in the CAN control register ([Table 26](#)).

When the UJA113x is in Normal mode, the CAN transceiver operating mode (Active, Listen-only or Offline) can be selected via bits CMC in the CAN control register ([Table 26](#)). When the UJA113x is in Standby or Sleep modes, the transceiver is forced to Offline or Offline Bias mode (depending on bus activity).

CAN Active mode: In CAN Active mode, the transceiver can transmit and receive data via CANH and CANL. The differential receiver converts the analog data on the bus lines into digital data, which is output on pin RXDC. The transmitter converts digital data generated by the CAN controller (input on pin TXDC) into analog signals suitable for transmission over the CANH and CANL bus lines.

CAN Active mode is selected when CMC = 01 or 10. When CMC = 01, VCAN undervoltage detection is enabled and the transceiver will go to CAN Offline or CAN Offline Bias mode when the voltage on VCAN drops below the undervoltage detection threshold, ($V_{VCAN} < V_{uvd}(VCAN)$). When CMC = 10, VCAN undervoltage detection is disabled. The transmitter will remain active until the voltage on V1 drops below the V1 reset threshold (selected via bits V1RTC). The SBC will then switch to Reset mode and the transceiver will switch to CAN Offline or CAN Offline Bias mode.

The CAN transceiver is in Active mode when:

- the UJA113x is in Normal mode (MC = 111) and the CAN transceiver has been enabled by setting bits CMC in the CAN control register to 01 or 10 (see [Table 26](#)) and:

- if CMC = 01, the voltage on pin VCAN is above the undervoltage detection threshold ($V_{\text{uvd}(\text{VCAN})}$)
- if CMC = 10, the voltage on pin V1 is above the V1 reset threshold OR
- the SBC is in Forced Normal mode with $V_{\text{VCAN}} > V_{\text{uvd}(\text{VCAN})}$

If pin TXDC is held LOW (e.g. by a short-circuit to GND) when CAN Active mode is selected via bits CMC, the transceiver will not enter CAN Active mode but will switch to or remain in CAN Listen-only mode. It will remain in Listen-only mode until pin TXDC goes HIGH in order to prevent a hardware and/or software application failure from driving the bus lines to an unwanted dominant state.

In CAN Active mode, the CAN bias voltage is derived from the supply voltage on VCAN.

The application can determine whether the CAN transceiver is ready to transmit/receive data or is disabled by reading the CAN Transceiver Status (CTS) bit in the Transceiver Status Register ([Table 28](#)).

CAN Listen-only mode: Listen-only mode enables basic selective wake-up using the CAN protocol controller in the host microcontroller. In Listen-only mode the CAN transmitter is disabled, reducing current consumption. The CAN receiver and CAN biasing remain active. This enables the host microcontroller to switch to a low-power mode in which an embedded CAN protocol controller remains active, waiting for a signal to wake up the microcontroller.

The CAN transceiver is in Listen-only mode when:

- the UJA113x is in Normal or Standby mode and CMC = 11 OR
- the UJA113x is in Forced Normal mode and $V_{\text{VCAN}} < V_{\text{uvd}(\text{VCAN})}$

Note that V_{VCAN} does not need to remain active ($> V_{\text{uvd}(\text{VCAN})}$) in CAN Listen-only mode. However, the CAN transceiver will not leave Listen-only mode while TXDC is LOW or if CAN Active mode is selected by setting CMC = 01 while $V_{\text{VCAN}} < V_{\text{uvd}(\text{VCAN})}$.

CAN Offline and Offline Bias modes: In CAN Offline mode, the transceiver monitors the CAN bus for a wake-up event, provided CAN wake-up detection is enabled (CWIE = 1; see [Table 67](#)). CANH and CANL are biased to GND.

CAN Offline Bias mode is the same as CAN Offline mode, with the exception that the CAN bus is biased to 2.5 V. This mode is activated automatically when activity is detected on the CAN bus while the transceiver is in CAN Offline mode. The transceiver will return to CAN Offline mode if the CAN bus is silent (no CAN bus edges) for longer than $t_{\text{to}(\text{silence})}$.

The CAN transceiver switches to CAN Offline mode from CAN Active or CAN Listen only mode if:

- the SBC switches to Sleep, Reset or FSP mode OR
- the SBC is in Normal mode and CMC = 00 OR
- the SBC is in Standby mode and CMC = 00, 01 or 10

provided the CAN-bus has been inactive for at least $t_{\text{to}(\text{silence})}$. If the CAN-bus has been inactive for less than $t_{\text{to}(\text{silence})}$, the CAN transceiver switches first to CAN Offline Bias mode and then to CAN Offline mode once the bus has been silent for $t_{\text{to}(\text{silence})}$.

The CAN transceiver switches to CAN Offline/Offline Bias mode from CAN Active mode if $CMC = 01$ and $V_{VCAN} < V_{uvd(VCAN)}$ or $CMC = 10$ and the voltage on V1 drops below the V1 reset threshold.

The CAN transceiver switches to CAN Offline mode:

- from CAN Offline Bias mode if no activity is detected on the bus (no CAN edges) for $t > t_{to(silence)}$ OR
- when the SBC switches from Off or Overtemp mode to Reset mode

The CAN transceiver switches from CAN Offline mode to CAN Offline Bias mode if:

- a standard wake-up pattern (according to ISO 11898-5) is detected on the CAN bus OR
- the SBC is in Normal mode, $CMC = 01$ and $V_{VCAN} < V_{uvd(VCAN)}$

CAN off mode: The CAN transceiver is switched off completely with the bus lines floating when:

- the SBC switches to Off or Overload mode OR
- $CSC \neq 00$ AND CAN shut down condition true OR
- V_{BAT} and V_{SMPS} fall below the CAN receiver undervoltage detection threshold, $V_{uvd(CAN)}$

It is switched on again on entering CAN Offline mode when V_{BAT} or V_{SMPS} is above the undervoltage release threshold ($V_{uvr(CAN)}$) and the SBC is no longer in Off/Overload mode. CAN Off mode prevents reverse currents flowing from the bus when the battery supply to the SBC is lost.

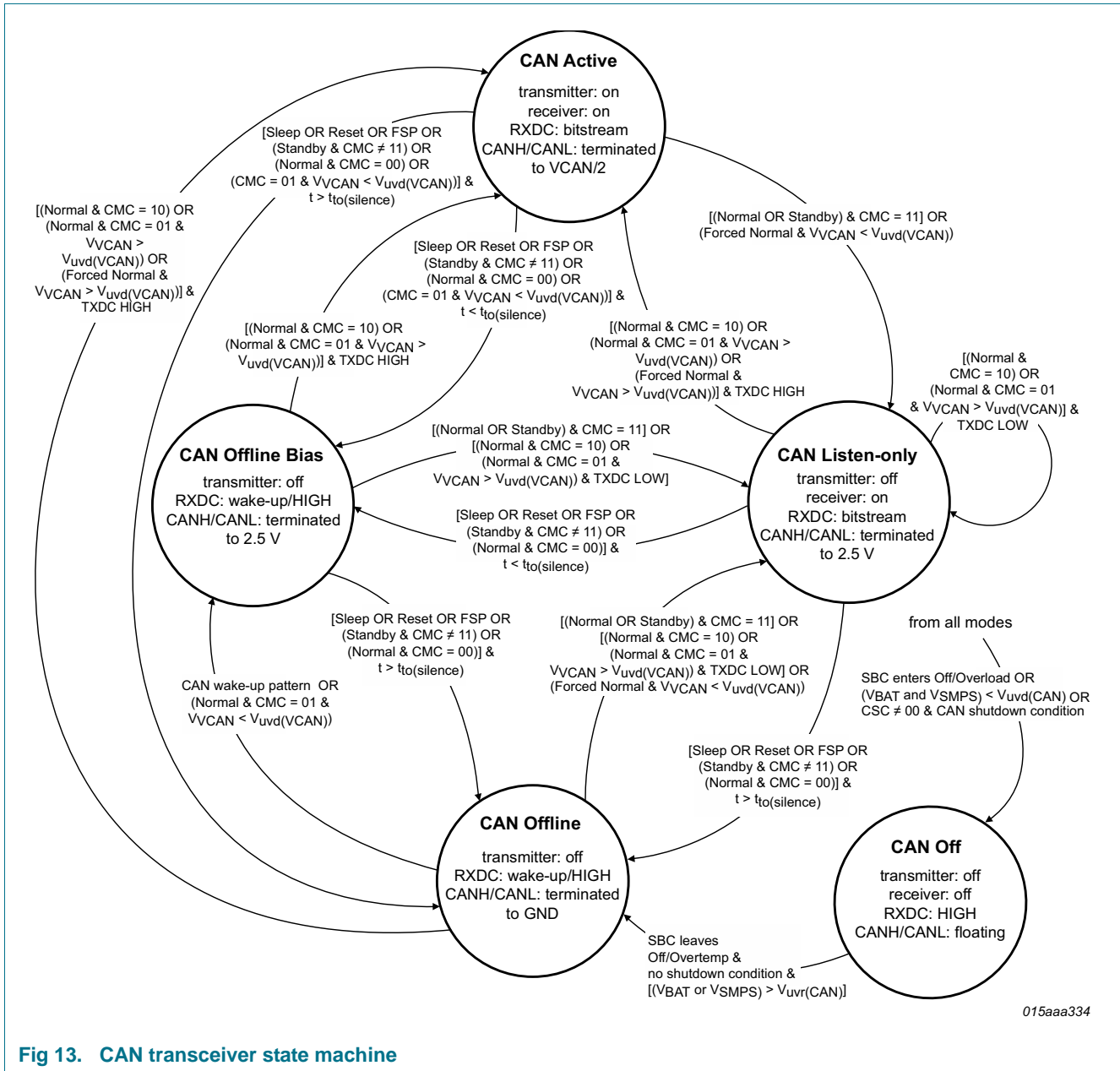

Fig 13. CAN transceiver state machine

7.9.1.2 CAN standard wake-up (partial networking not enabled)

If the CAN transceiver is in Offline or Offline Bias mode and CAN wake-up is enabled (CWIE = 1), but CAN selective wake-up is disabled (CPNC = 0 or PNCOK = 0), the UJA113x will monitor the bus for a wake-up pattern.

A filter at the receiver input prevents unwanted wake-up events occurring due to automotive transients or EMI. A dominant-recessive-dominant wake-up pattern must be transmitted on the CAN bus within the wake-up timeout time (t_{to(wake)}) to pass the wake-up filter and trigger a wake-up event (see Figure 14; note that additional pulses may occur between the recessive/dominant phases). The recessive and dominant phases must last at least t_{wake(busrec)} and t_{wake(busdom)}, respectively.



Fig 14. CAN wake-up timing showing a valid wake-up pattern

When a valid CAN wake-up pattern is detected on the bus, CAN wake-up interrupt bit CWI in the Transceiver interrupt status register is set (see Table 60) and pin RXDC is driven LOW. If the SBC was in Sleep mode when the wake-up pattern was detected, V1 is enabled to supply the microcontroller and the SBC switches to Standby mode via Reset mode.

7.9.1.3 CAN partial networking (UJ113xFD only)

Partial networking allows nodes in a CAN network to be selectively activated in response to dedicated wake-up frames (WUF). Only nodes that are functionally required are active on the bus while the other nodes remain in a low-power mode until needed.

If both CAN wake-up detection (CWIE = 1) and CAN selective wake-up (CPNC = 1) are enabled, and the partial networking registers are configured correctly (PNCOK = 1), the transceiver monitors the bus for dedicated CAN wake-up frames.

Wake-up frame (WUF): A wake-up frame is a CAN frame according to ISO11898-1:2003, consisting of an identifier field (ID), a Data Length Code (DLC), a data field and a Cyclic Redundancy Check (CRC) code including the CRC delimiter.

The wake-up frame format, standard (11-bit) or extended (29-bit) identifier, is selected via bit IDE in the Frame control register (Table 32).

A valid WUF identifier is defined and stored in the ID registers (Table 30). An ID mask can be defined to allow a group of identifiers to be recognized as valid by an individual node. The identifier mask is defined in the mask registers (Table 31), where a 1 means 'don't care'.

In the example illustrated in Figure 15, based on the standard frame format, the 11-bit identifier is defined as 0x1A0. The identifier is stored in ID registers 2 (0x29) and 3 (0x2A). The three least significant bits of the ID mask, bits 2 to 4 of Mask register 2 (0x2D), are set to 1, which means that the corresponding identifier bits are 'don't care'. This means that any of eight different identifiers will be recognized as valid in the received WUF (from 0x1A0 to 0x1A7).

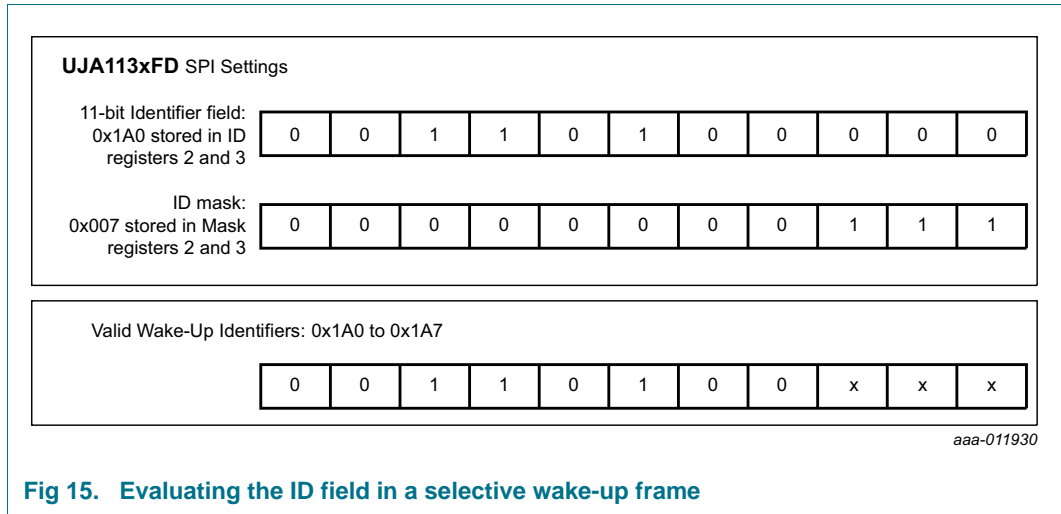

The data field indicates which nodes are to be woken up. Within the data field, groups of nodes can be predefined and associated with bits in a data mask. By comparing the incoming data field with the data mask, multiple groups of nodes can be woken up simultaneously with a single wake-up message.

The data length code (bits DLC in the Frame control register; [Table 32](#)) determines the number of data bytes (between 0 and 8) expected in the data field of a CAN wake-up frame. If one or more data bytes are expected (DLC ≠ 0000), at least one bit in the data field of the received wake-up frame must be set to 1 and at least one equivalent bit in the associated data mask register in the transceiver (see [Table 33](#)) must also be set to 1 for a successful wake-up. Each matching pair of 1s indicates a group of nodes to be activated (since the data field is up to 8 bytes long, up to 64 groups of nodes can be defined). If DLC = 0, a data field is not expected.

In the example illustrated in [Figure 16](#), the data field consists of a single byte (DLC = 1). This means that the data field in the incoming wake-up frame is evaluated against data mask 7 (stored at address 6Fh; see [Table 33](#) and [Figure 19](#)). Data mask 7 is defined as 10101000 in the example. This means the node is assigned to three groups (Group1, Group 3 and Group 5).

The received message shown in [Figure 16](#) could, potentially, wake up four groups of nodes: groups 2, 3, 4 and 5. Two matches are found (groups 3 and 5) when the message data bits are compared with the configured data mask (DM7).



Optionally, the data length code and the data field can be excluded from the evaluation of the wake-up frame. If bit PNDM = 0, only the identifier field is evaluated to determine if the frame contains a valid wake-up message. If PNDM = 1 (the default value), the data field is included for wake-up filtering.

When PNDM = 0, a valid wake-up message is detected and a wake-up event is captured (and CW is set to 1) when:

- the identifier field in the received wake-up frame matches the pattern in the ID registers after filtering AND
- the CRC field in the received frame (including a recessive CRC delimiter) was received without error

When PNDM = 1, a valid wake-up message is detected when:

- the identifier field in the received wake-up frame matches the pattern in the ID registers after filtering AND
- the frame is not a Remote frame AND
- the data length code in the received message matches the configured data length code (bits DLC) AND
- if the data length code is greater than 0, at least one bit in the data field of the received frame is set and the corresponding bit in the associated data mask register is also set AND
- the CRC field in the received frame (including a recessive CRC delimiter) was received without error

If the UJA113xFD receives a CAN message containing errors (e.g. a 'stuffing' error) that are transmitted in advance of the ACK field, an internal error counter is incremented. If a CAN message is received without any errors appearing in front of the ACK field, the counter is decremented. Data received after the CRC delimiter and before the next Start of Frame (SOF) is ignored by the partial networking module. If the counter overflows (counter > 31), a frame detect error is captured (PNFDEI = 1) and the device wakes up; the counter is reset to zero when the bias is switched off and partial networking is re-enabled.

Partial networking is assumed to be configured correctly when PNCOK is set to 1 by the application software. The UJA113xFD clears PNCOK after a write access to any of the CAN partial networking configuration registers (see [Section 7.9.8](#)).

If selective wake-up is disabled (CPNC = 0) or partial networking is not configured correctly (PNCOK = 0), and the CAN transceiver is in Offline mode with wake-up enabled (CWIE = 1), then any valid wake-up pattern according to ISO 11898-2:201x (upcoming merged ISO 11898-2/5/6 standard) will trigger a wake-up event.

If the CAN transceiver is not in Offline or Offline Bias mode (CMC ≠ 00) or CAN wake-up is disabled (CWIE = 0), all wake-up patterns on the bus will be ignored.

CAN FD frames: CAN FD stands for 'CAN with Flexible Data-Rate'. It is based on the CAN protocol as specified in the upcoming ISO 11898-1:201x standard.

CAN FD is being gradually introduced into automotive market. In time, all CAN controllers will be required to comply with the new standard (enabling 'FD-active' nodes) or at least to tolerate CAN FD communication (enabling 'FD-passive' nodes). The UJA113xFD supports FD-passive features by means of a dedicated implementation of the partial networking protocol.

The UJA113xFD can be configured to recognize CAN FD frames as valid CAN frames. When CFDC = 1, the error counter is decremented every time the control field of a CAN FD frame is received. The UJA113xFD remains in low-power mode (CAN FD-passive) with partial networking enabled. CAN FD frames are never recognized as valid wake-up frames, even if PNDM = 0 and the frame contains a valid ID. After receiving the control field of a CAN FD frame, the UJA113xFD ignores further bus signals until idle is again detected.

CAN FD frames are interpreted as frames with errors by the partial networking module when CFDC = 0. So the error counter is incremented when a CAN FD frame is received. If the ratio of CAN FD frames to valid CAN frames exceeds the threshold that triggers error counter overflow, bit PNFDEI is set to 1 and the device wakes up.

7.9.1.4 Fail-safe features

TXDC dominant time-out: A TXDC dominant time-out timer is started when pin TXDC is forced LOW while the transceiver is in Active Mode. If the LOW state on pin TXDC persists for longer than the TXDC dominant time-out time ($t_{to(dom)TXDC}$), the transmitter is disabled, releasing the bus lines to recessive state. A CAN failure interrupt (CFI) is generated, if enabled (CFIE = 1; see [Table 67](#)).

This function prevents a hardware and/or software application failure from driving the bus lines to a permanent dominant state (blocking all network communications). The TXDC dominant time-out timer is reset when pin TXDC goes HIGH. The status of the TXDC dominant time-out can be read via bit CFS in the Transceiver status register ([Table 28](#)). The TXDC dominant time-out time also defines the minimum possible bit rate of 40 kbit/s.

Pull-up on TXDC pin: Pin TXDC has an internal pull-up towards V1 to ensure a safe defined state in case the pin is left floating.

CAN failure interrupt: A CAN failure interrupt is triggered (CFI = 1), if enabled, when status bit VCS (indicating that $V_{VCAN} < V_{uvd(VCAN)}$) or status bit CFS (indicating that pin TXDC is clamped LOW) is set to 1.

CAN shut down in response to a battery under- or overvoltage: The CAN transceiver can be configured to shut down if the battery monitor detects an under- or overvoltage on the battery supply (see [Section 7.8.2](#)). The response of the CAN transceiver (to a BMUI and/or BMOI interrupt) is configured via bits CSC in the CAN control register ([Table 26](#)). This feature makes it possible to reduce current consumption very quickly when the battery supply voltage drops below the undervoltage threshold, and/or to limit power consumption when the battery supply voltage rises above the overvoltage threshold.

7.9.2 LIN transceiver(s)

The LIN transceiver(s) provides the interface between a Local Interconnect Network (LIN) master/slave protocol controller and the physical bus in a LIN network. It is primarily intended for in-vehicle sub-networks using baud rates from 1 kBd up to 20 kBd.

For optimum support of LIN slave applications, the transceiver(s) contains an integrated LIN slave termination resistor (connected between the LIN pin and pin BAT).

7.9.2.1 LIN 2.x/SAE J2602 compliant

The UJA113x is fully LIN 2.0, LIN 2.1, LIN 2.2, LIN 2.2A and SAE J2602 compliant. Since the LIN physical layer is independent of higher OSI model layers (e.g. the LIN protocol), nodes containing a LIN 2.2A-compliant physical layer can be combined, without restriction, with LIN physical layer nodes that comply with earlier revisions (LIN 1.0, LIN 1.1, LIN 1.2, LIN 1.3, LIN 2.0, LIN 2.1 and LIN 2.2).

7.9.3 LIN operating modes

The integrated LIN transceiver(s) supports three operating modes: Active, Offline and Listen only. In the UJA1132 and UJA1136, the dual LIN transceivers can be controlled independently, so one can be active while the other is off.

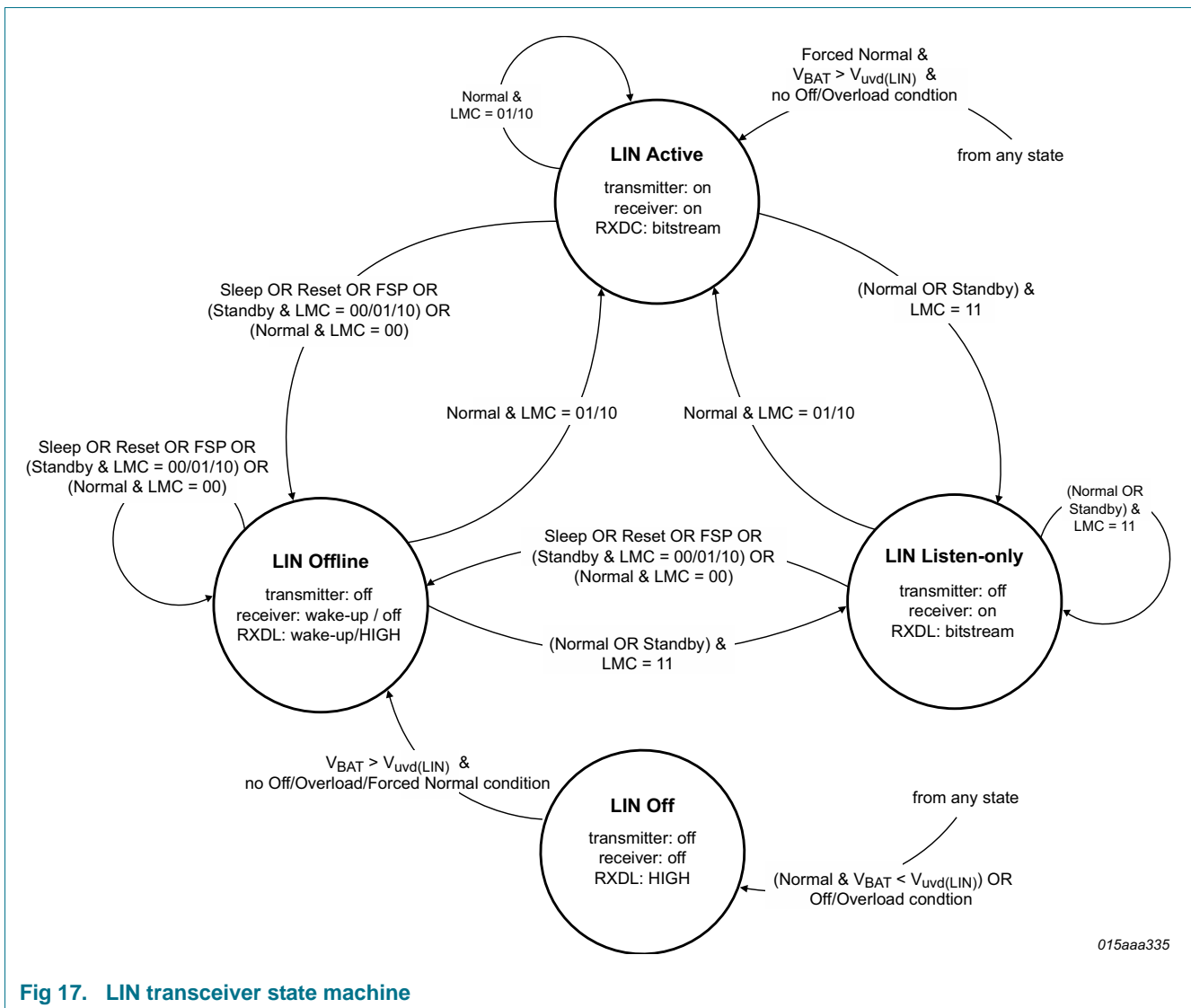

Fig 17. LIN transceiver state machine

7.9.3.1 LIN Active mode

In LIN Active mode, the transceiver can transmit and receive data via the LIN bus pins.

The receiver detects data streams on the LIN bus (via pin LINn) and transfers the input data to the microcontroller via pin RXDLn. LIN recessive is represented by a HIGH level on RXDLn; LIN dominant is represented by a LOW level.

Transmit data streams from the protocol controller on the TXDLn input are converted by the transmitters into optimized bus signals shaped to minimize EME.

The LIN transceiver is in Active mode when:

- the SBC is in Normal mode (MC = 111) and the LIN transceiver has been enabled by setting bit LMCn in the LIN mode control register to 01 or 10 (see [Table 27](#)) and the supply voltage on pin BAT is above the LIN undervoltage detection threshold ($V_{BAT} > V_{uvd(LIN)}$) OR
- the SBC is in Forced Normal mode (FNMC = 1) and the supply voltage on pin BAT is above the LIN undervoltage detection threshold ($V_{BAT} > V_{uvd(LIN)}$)

7.9.3.2 LIN Offline mode

In Offline mode, the LIN transceiver monitors the LIN bus for a remote wake-up event, provided LIN wake-up detection is enabled (LWInE = 1; see [Table 67](#)) and $V_{BAT} > V_{uvd(LIN)}$.

A filter at the receiver input prevents automotive transients or EMI triggering invalid wake-up events. A LOW level on the LIN bus lasting at least $t_{wake(dom)LIN}$ followed by a rising edge triggers a remote wake-up event (see [Figure 18](#)). Pin RXDLx is driven LOW and an LWIn interrupt is generated to signal to the microcontroller that a remote wake-up event has been detected. If the SBC is in Sleep mode when the remote-wake up event is triggered, it switches to Standby mode, enabling the microcontroller supply on V1.

The LIN transceiver switches to LIN Offline mode from LIN Active or LIN Listen-only mode when:

- the SBC is in Sleep, Reset or FSP mode OR
- the SBC is in Normal mode with LMCn = 00 OR
- the SBC is in Standby mode with LMCn = 00, 01 or 10 OR

and from LIN Off mode when:

- the supply voltage on pin BAT is above the LIN undervoltage detection threshold ($V_{BAT} > V_{uvd(LIN)}$) and the SBC is not in Off or Overload mode.



Fig 18. LIN wake-up timing diagram

7.9.3.3 LIN Listen-only mode

In Listen-only mode, the LIN transmitter is disabled. The LIN receiver remains active, allowing the microcontroller to monitor activity on the bus while not transmitting.

The LIN transceiver is in Listen-only mode when:

- the SBC is in Normal or Standby mode AND
- $LMCn = 11$ AND
- the supply voltage on pin BAT is above the LIN undervoltage detection threshold ($V_{BAT} > V_{uvd(LIN)}$)

7.9.3.4 LIN Off mode

The LIN transceiver is switched off completely in LIN Off mode. The bus lines are released and remain in recessive state. The receiver is deactivated and unable to respond to a wake-up pattern. The transceiver switches to LIN Off mode when:

- the SBC switches to Off or Overload mode OR
- V_{BAT} falls below the LIN undervoltage detection threshold, $V_{uvd(LIN)}$, while the SBC is in Normal mode (undervoltage monitoring is switched off in Standby, Sleep and Reset modes)

7.9.4 Fail-safe features

7.9.4.1 General fail-safe features

The following fail-safe features have been implemented:

- Pin TXDLn has an internal pull-up towards V1 to guarantee safe, defined states if this pin is left floating
- The transmitter output stage current is limited in order to protect the transmitter against short circuits to pin BAT
- A loss of power (pins BAT and GND) has no impact on the bus lines or on the microcontroller. No reverse currents flow from the bus.

7.9.4.2 TXDL dominant time-out

A TXDL dominant time-out timer circuit prevents the bus lines being driven to a permanent dominant state (blocking all network communications) if pin TXDLn is forced permanently LOW by a hardware and/or software application failure. The timer is triggered by a negative edge on TXDLn. If the pin remains LOW for longer than the TXDL dominant time-out time ($t_{to(dom)TXDL}$), the transmitter is disabled, driving the bus line to a recessive state. The timer is reset by a positive edge on TXDLn.

This function can be disabled (via bits LSCn; see [Table 27](#)) to allow the UJA113x to be used in applications requiring the transmission and/or reception of long LOW sequences.

7.9.5 LIN slope control

Automatic slope control has been incorporated into the LIN transmitter, so it is not necessary to select the bit rate.

7.9.6 Operation when supply voltage is outside specified operating range

If $V_{BAT} > 18\text{ V}$ or $V_{BAT} < 5\text{ V}$, the LIN transceiver may remain operational, but parameter values cannot be guaranteed to remain within the operating ranges specified in [Table 90](#) and [Table 91](#).

In LIN Active mode:

- If the input level on pin TXDLn is HIGH, the LIN transmitter output on pin LINn will be recessive.
- If the input level on pin LINn is recessive, the receiver output on pin RXDLn will be HIGH.
- If the voltage on pin V_{BAT} rises to 28 V (e.g. during an automotive jump-start), reliable LIN data transfer is still supported
- If $V_{BAT} < V_{uvd(LIN)}$, the LIN transceiver switches to Off mode (note that LIN undervoltage detection is only active while the SBC is in Normal mode).

7.9.7 Transceiver control and status registers

Table 26. CAN control register (address 20h)

Bit	Symbol	Access	Value	Description
7	reserved	R	-	
6	CFDC	R/W	[1]	CAN FD control:
			0	CAN FD tolerance disabled
			1	CAN FD tolerance enabled
5	PNCOK	R/W	[1]	CAN partial networking configuration OK:
			0	partial networking register configuration invalid (wake-up via standard wake-up pattern only)
			1	partial networking registers configured successfully
4	CPNC	R/W	[1]	CAN partial networking control:
			0	disable CAN selective wake-up
			1	enable CAN selective wake-up
3:2	CSC	R/W		CAN shut-down control:
			00	CAN transceiver is not shut down when a battery monitor under- or overvoltage interrupt is generated
			01	CAN transceiver shuts down in response to a battery monitor undervoltage (BMUI) interrupt (SBC in Normal mode)
			10	CAN transceiver shuts down in response to a battery monitor overvoltage (BMOI) interrupt (SBC in Normal mode)
			11	CAN transceiver shuts down in response to a BMUI or BMOI interrupt (SBC in Normal mode)
1:0	CMC	R/W		CAN transceiver operating mode selection:
			00	Offline/Offline Bias mode
			01	Active mode (when the SBC is in Normal mode)
			10	Active mode (when the SBC is in Normal mode); VCAN undervoltage disabled
			11	Listen-only mode

[1] Valid for UJA113xFD/x variants only; otherwise reserved.

Table 27. LIN control register (address 21h)

Bit	Symbol	Access	Value	Description
7:6	LSC2	R/W	[1]	LIN2 slope control:
			00	slope control active
			01	slope control active
			10	slope control active and TXDL dominant time-out deactivated
			11	reserved

Table 27. LIN control register (address 21h) ...continued

Bit	Symbol	Access	Value	Description
5:4	LMC2	R/W	[1]	LIN2 transceiver operating mode selection:
			00	Offline
			01	Active mode (when the SBC is in Normal mode)
			10	Active mode (when the SBC is in Normal mode)
			11	Listen-only mode
3:2	LSC1	R/W		LIN/LIN1 slope control:
			00	slope control active
			01	slope control active
			10	slope control active and TXDL dominant time-out deactivated
			11	reserved
1:0	LMC1	R/W		LIN/LIN1 transceiver operating mode selection:
			00	Offline
			01	Active mode (when the SBC is in Normal mode)
			10	Active mode (when the SBC is in Normal mode)
			11	Listen-only mode

[1] UJA1132 and UJA1136 only; bits 7:4 are reserved in the UJA1131 and UJA1135 and should remain cleared.

Table 28. Transceiver status register (address 22h)

Bit	Symbol	Access	Value	Description
7	CTS	R		CAN transmitter status:
			0	CAN transmitter disabled
			1	CAN transmitter ready to transmit data
6	CPNERR	R	[1]	CAN partial networking error:
			0	no CAN partial networking error detected (PNFDEI = 0 AND PNCOK = 1)
			1	CAN partial networking error detected (PNFDEI = 1 OR PNCOK = 0; wake-up via standard wake-up pattern only)
5	CPNS	R	[1]	CAN partial networking status:
			0	CAN partial networking configuration error detected (PNCOK = 0)
			1	CAN partial networking configuration ok (PNCOK = 1)
4	COSCS	R	[1]	CAN oscillator status:
			0	CAN partial networking oscillator not running at target frequency
			1	CAN partial networking oscillator running at target frequency
3	CBSS	R		CAN-bus silence status:
			0	CAN-bus has been inactive for less than $t_{to(silence)}$
			1	CAN-bus has been inactive for longer than $t_{to(silence)}$

Table 28. Transceiver status register (address 22h) ...continued

Bit	Symbol	Access	Value	Description
2	VLINS	R		LIN supply status:
			0	LIN supply ok in Normal mode or SBC not in Normal mode
			1	LIN switched to Offline mode due to a LIN undervoltage event in Normal mode
1	VCS	R		CAN supply status:
			0	VCAN undervoltage detection is deactivated or the CAN supply is above the undervoltage threshold ($V_{VCAN} > V_{uvd(VCAN)}$) with VCAN undervoltage detection active (it is only active when the SBC is in Normal mode and CMC = 01 or CMC = 11)
			1	CAN supply is below the undervoltage threshold ($V_{VCAN} < V_{uvd(VCAN)}$) with the SBC in Normal mode and CMC = 01 or CMC = 11
0	CFS	R		CAN failure status:
			0	no failure detected
			1	CAN transmitter disabled due to a TXDC dominant time-out event

[1] Valid for UJA113xFD/x variants only; otherwise reserved.

7.9.8 CAN partial networking configuration registers

Dedicated registers are provided for configuring CAN partial networking.

Table 29. Data rate register (address 26h)

Bit	Symbol	Access	Value	Description
7:3	reserved	R	-	
2:0	CDR	R/W		CAN data rate selection:
			000	50 kbit/s
			001	100 kbit/s
			010	125 kbit/s
			011	250 kbit/s
			100	reserved (intended for future use; currently selects 500 kbit/s)
			101	500 kbit/s
			110	reserved (intended for future use; currently selects 500 kbit/s)
			111	1000 kbit/s

Table 30. ID registers 0 to 3 (addresses 27h to 2Ah)

Addr.	Bit	Symbol	Access	Value	Description
27h	7:0	ID7:ID0	R/W	-	bits ID7 to ID0 of the extended frame format
28h	7:0	ID15:ID8	R/W	-	bits ID15 to ID8 of the extended frame format
29h	7:2	ID23:ID18	R/W	-	bits ID23 to ID18 of the extended frame format bits ID5 to ID0 of the standard frame format
	1:0	ID17:ID16	R/W	-	bits ID17 to ID16 of the extended frame format
2Ah	7:5	reserved	R	-	
	4:0	ID28:ID24	R/W	-	bits ID28 to ID24 of the extended frame format bits ID10 to ID6 of the standard frame format

Table 31. ID mask registers 0 to 3 (addresses 2Bh to 2Eh)

Addr.	Bit	Symbol	Access	Value	Description
2Bh	7:0	IDM7:IDM0	R/W	-	ID mask bits 7 to 0 of extended frame format
2Ch	7:0	IDM15:IDM8	R/W	-	ID mask bits 15 to 8 of extended frame format
2Dh	7:2	IDM23:IDM18	R/W	-	ID mask bits 23 to 18 of extended frame format ID mask bits 5 to 0 of standard frame format
	1:0	IDM17:IDM16	R/W	-	ID mask bits 17 to 16 of extended frame format
2Eh	7:5	reserved	R	-	
	4:0	IDM28:IDM24	R/W	-	ID mask bits 28 to 24 of extended frame format ID mask. bits 10 to 6 of standard frame format

Table 32. Frame control register (address 2Fh)

Bit	Symbol	Access	Value	Description
7	IDE	R/W	-	identifier format:
			0	standard frame format (11-bit)
			1	extended frame format (29-bit)

Table 32. Frame control register (address 2Fh) ...continued

Bit	Symbol	Access	Value	Description
6	PNDM	R/W	-	partial networking data mask:
			0	data length code and data field are 'don't care' for wake-up
			1	data length code and data field are evaluated at wake-up
5:4	reserved	R	-	
3:0	DLC	R/W		number of data bytes expected in a CAN frame:
			0000	0
			0001	1
			0010	2
			0011	3
			0100	4
			0101	5
			0110	6
			0111	7
			1000	8
			1001 to 1111	tolerated, 8 bytes expected

Table 33. Data mask registers (addresses 68h to 6Fh)

Addr.	Bit	Symbol	Access	Value	Description
68h	7:0	DM0	R/W	-	data mask 0 configuration
69h	7:0	DM1	R/W	-	data mask 1 configuration
6Ah	7:0	DM2	R/W	-	data mask 2 configuration
6Bh	7:0	DM3	R/W	-	data mask 3 configuration
6Ch	7:0	DM4	R/W	-	data mask 4 configuration
6Dh	7:0	DM5	R/W	-	data mask 5 configuration
6Eh	7:0	DM6	R/W	-	data mask 6 configuration
6Fh	7:0	DM7	R/W	-	data mask 7 configuration



Fig 19. Data mask register usage for different values of DLC

7.10 High-voltage input/output pins (HVIOs; not available in UJA113xFD/0)

The UJA113x contains 4 or 8 high-voltage input/output pins (HVIO) that can be configured via the SPI as high- or low-side drivers or as wake-up inputs. They are clustered in 1 or 2 banks of 4 HVIO pins. HVIO1 to HVIO4 belong to bank 0; HVIO5 to HVIO8 belong to bank 1. Each bank has its own dedicated supply pin (BATHS1 and BATHS2 respectively). The BATHSx pins can be supplied independently from the battery, the SMPS or from one of the voltage regulators, provided the supply voltage remains within the specified range. The structure of the HVIOs is depicted in [Figure 20](#).



The high- and low-side drivers allow the HVIOs to be used, for example, to supply sensors or an LED chain or for biasing switches. The HVIOs could be used in combination with the four integrated timers to synchronously bias and sample switches or to generate PWM signals for adjusting the brightness of LEDs. Two or more HVIOs can be combined to form a single output with increased driver capability. In addition, the HVIOs can be configured to generate limp home signals or to control hazard lights.

7.10.1 HVIO configuration

A dedicated control register is provided for each of the 8 HVIO pins ([Table 34](#)). Before it can be used, an HVIO pin must first be configured via bits IOnCC. These control bits are used to assign a high-level function to each of the HVIO pins. If an HVIO pin is not configured (IOnCC = 000), the output drivers are off and the input is deactivated. All other control bits are ignored.

Once an HVIO pin has been configured, it can be activated via bits IOnAC. An HVIO can be permanently enabled or disabled, or it can be controlled by one of the four integrated timers. If an HVIO is configured as an output driver, the output is activated by each pulse of the associated timer signal. This allows an output to be cyclically activated or controlled by a PWM signal.

Remark: HVIO outputs configured as low-side drivers are only enabled while the SBC is in Normal mode.

If an HVIO is configured as a wake-up input, control bits IOnAC define the sampling scheme. If the HVIO is permanently deactivated, then the wake input is never sampled. If the pin is permanently enabled, it is sampled at a rate of $f_{s(wake)}$. If it is controlled by a timer, the sample rate is determined by the frequency of the timer signal (the sample point is at the end of the timer pulse). HVIO control via a timer is depicted in [Figure 21](#).



Fig 21. Example of HVIO control via a timer

The wake-up detection threshold can be configured separately for each bank of HVIOs. The threshold can be GND-based or ratiometric to the relevant BATHSx supply voltage. The wake-up thresholds for bank 0 and bank 1 are configured via bits B0WTC and B1WTC, respectively, in the wake-up threshold control registers ([Table 35](#) and [Table 36](#)). Bits IOnWLS in the wake-up status registers ([Table 37](#) and [Table 38](#)) can be read to determine whether the input levels on the HVIO pins were above or below the selected threshold when last sampled. Note that the wake-up status information is only valid for HVIOs configured as wake-up inputs.

If the SBC detects a rising or falling edge on an HVIO that is configured as a wake-up input, it generates a wake-up interrupt (IONREI or IONFEI), if enabled (see [Table 68](#) and [Table 70](#)).

7.10.1.1 HVIO slope control

The HVIO output drivers are equipped with a slope control mechanism that can be activated via the IOnCC control bits. The purpose of slope control is to minimize electro-magnetic emissions, when necessary.

Low-side driver slope control: When slope control is disabled, the LS-driver behaves as a regular switch: when activated, the on-resistance immediately changes from infinite to $R_{on(HVIO_n-GND)}$. When slope control is enabled, the LS-driver behaves as a current source: when activated, the output sink current goes from zero to $I_{sink(Act)HVIO}$. The on-resistance changes to $R_{on(HVIO_n-GND)}$ after a fixed delay of $t_{d(on)HVIO}$. This allows the user to adjust the dV/dt on the HVO output by selecting the output capacitance.

HIGH-side driver slope control: When slope control is disabled, the HS-driver behaves as a regular switch: when activated, the on-resistance immediately changes from infinite to $R_{on(BATHS_x-HVIO_n)}$. When slope control is enabled, the HS-driver initially acts as a slope-controlled voltage source. After a fixed time, $t_{d(on)HVIO}$, the HS-driver on-resistance changes to $R_{on(BATHS_x-HVIO_n)}$. This behavior helps to limit the dV/dt on the HVIO output

7.10.2 Direct control of HVIOs (only valid for variants with 8 HVIO pins)

The direct control feature allows an HVIO on bank 0 to be controlled directly from an HVIO on bank 1 (without involving the SPI interface). The controlled HVIO on bank 0 must be configured as a high- or low-side driver and the 'direct control' option must be selected (IOnAC = 110 for inverted control or IOnAC = 111 for non-inverted control). Input and output assignment is fixed - HVIO_n of bank 0 is assigned to HVIO_(n+4) of bank 1.

The 'controlling' HVIO on bank 1 does not need to be activated. It only needs an input configuration (wake-up input or HS-driver and wake-up input). However, it will need to be activated before its status can be read or associated interrupts enabled.

The direct control pairings can be individually enabled and the configuration of one HVIO pair has no impact on other HVIO functions.

Note that the direct control option is not available for HVIO2, HVIO3 or HVIO4 if they are configured as limp home outputs in MTPNV memory (see [Section 7.10.6](#)).

7.10.3 Short-circuit and open load detection

The HVIO output drivers are protected against short circuits and open loads.

When a short circuit is detected on an HVIO, the output driver is automatically deactivated. A short-circuit failure is reported via the driver status register (bits IOnDS = 10; see [Table 39](#) and [Table 40](#)). To reactivate the HVIO, the associated activation control bits must be reset to 000 (bits IOnAC; see [Table 34](#)), which clears the driver status bits (IOnDS = 00; driver is OK). The HVIO can then be reactivated (again via bits IOnAC, as described in [Section 7.10.1](#)). If the short circuit is still present, the HVIO is again deactivated. The HVIO short-circuit thresholds can be set individually via bits IOnSCTC (see [Table 41](#) and [Table 43](#)).

The UJA113x is also able to detect open-load failures. However, in contrast to the response to a short-circuit, the output driver is not deactivated when an open load is detected. The open-load failure is reported via the driver status register (bits IOnDS = 01; see [Table 39](#) and [Table 40](#)). The relevant status bit remains set to 01 until the driver current rises above the open-load threshold. The HVIO open-load detection thresholds

can be set individually via bits IOnOLTC (see [Table 42](#) and [Table 44](#)).

If the SBC detects an HVIO short-circuit or open-load failure, an IOnSCI or IOnOLI interrupt is generated, if enabled (see [Section 7.12](#)). If the UJA113x is in Sleep mode, the interrupt triggers a wake-up event.

Note that short-circuit/open-load detection is only enabled when an HVIO driver is switched on. When an HVIO is controlled by a timer, diagnostic status information is updated when the driver switches on.

A minimum HVIO on-time is required for open-load failure detection. A failure may not be detected if the on-time is less than $t_{\text{det(fail)HVIO}}$ due to a short duty cycle. Once a failure has been detected, an open load failure is reported (IONDS = 01). The open load failure is automatically recovered when the current the HVIO pin is driving exceeds the open-load threshold for the HVIO failure recovery time $t_{\text{rec(HVIO)}}$.

Note that positive currents flow into the IC and negative currents flow out of the IC - so both positive and negative thresholds are defined. For a LS-driver, the open-load threshold is exceeded when the driving current is above the positive threshold ($> I_{\text{th(det)open}}$; see [Table 90](#)). For a HS-driver, the open-load threshold is exceeded when the driving current is below the negative threshold ($< I_{\text{th(det)open}}$).

7.10.4 Automatic load shedding

It may be desirable to deactivate the HVIOs as soon as possible in response to a battery under- or overvoltage event. For an overvoltage, this feature can prevent overload conditions in the SBC or in external loads. For an undervoltage, it can help maintain the charge in the battery capacitor to keep the module operational for as long as possible.

The UJA113x provides the option to deactivate the HVIO ports individually (input or output) in the event of an under- or overvoltage. This option helps to reduce the reaction time without burdening the microcontroller.

The HVIOs are configured via bits IOnSC in the HVIO control registers (see [Table 34](#)). The under- and overvoltage thresholds are defined by the battery monitor thresholds, BMOTC and BMUTC (see [Section 7.8.2](#)). HVIO ports are automatically reactivated when the under- or overvoltage condition is removed. Note that shutdown control is only active while the SBC is in Normal Mode.

The HVIOs switch to a fail-safe state when the SBC enters Overload mode (see [Section 7.1.1.5](#)). For HVIOs configured as limp-home outputs (HVIO2, HVIO3, and/or HVIO4; see [Section 7.10.6](#)), the selected limp-home functions are activated when the HVIOs switch to fail-safe state. Otherwise, the HVIO drivers are de-activated.

7.10.5 Safety features

For certain applications it can be critical to ensure that an HVIO high- or low-side driver is not activated accidentally. To prevent this happening, a driver can be deactivated via bits IOnHOC and IOnLOC in non-volatile memory (see [Table 45](#) and [Table 46](#)). Non-volatile memory settings have the highest priority. That means that conflicting SPI register settings in standard memory are overruled.

7.10.6 HVIO pins configured as limp home outputs

The LIMP pin is provided to enable 'limp home' hardware in the event of an ECU failure (see [Section 7.5](#)). Pins HVIO2, HVIO3 and HVIO4 can be used to provide additional limp home functionality. When the limp home control bit is set (LHC = 1; see [Table 12](#)), the following functions are supported:

- HVIO2 can be configured as a statically active high-side driver
- HVIO3 can be configured as a high-side switch supplying a 100 Hz PWM signal with a 10 % duty cycle
- HVIO4 can be configured as a high-side switch supplying a 1.25 Hz PWM signal with a 50 % duty cycle

Bit LHC is set automatically in Overload and FSO modes but can also be set via the SPI.

Limp home functionality is enabled for the HVIO pins via the IOnSFC control bits in the Start-up control register ([Table 11](#)). The Start-up control register is located in the non-volatile memory bank so this function can be enabled automatically at power-on. When HVIO2, HVIO3 and HVIO4 are configured as limp home outputs, the bit settings in the dedicated control registers are ignored.

Timer 3 and Timer 4 provide the clock signals for HVIO3 and HVIO4, respectively. When these HVIOs are configured as limp home outputs (LHC = 1; IOnSFC = 1), the timers are dedicated to the HVIOs and cannot be used for any other purpose. Timer 3 and Timer 4 control settings are ignored (see [Section 7.11](#)).

Short-circuit and open-load detection is enabled for HVIO2, HVIO3 and HVIO4 when they are configured as limp home outputs. The HVIO output driver is deactivated when a short-circuit is detected. In order to recover from a short-circuit failure, the HVIO must be deactivated and reactivated via the SPI by resetting and then setting bit LHC.

Note that when an HVIO is configured as a limp home output, its high-side driver should not be deactivated via bit IOnHOC in non-volatile memory (see [Table 45](#)).

7.10.7 HVIO control and status registers

HVIO control and status registers are not available in the UJA113xFD/0. HVIO bank 1 (HVIO5 to HVIO 8) registers are not available in the UJA113xFD/4.

Table 34. HVIO control registers^[1]

Bit	Symbol	Access	Value	Description
7:6	IOnSC	R/W		HVIO shutdown control:
			00	HVIO does not respond to a battery over- or undervoltage
			01	HVIO shuts down when battery undervoltage is detected in Normal mode
			10	HVIO shuts down when battery overvoltage is detected in Normal mode
			11	HVIO shuts down when battery over- or undervoltage is detected in Normal mode
5:3	IOnAC	R/W		HVIO activation control:
			000	HVIO is deactivated
			001	HVIO is enabled
			010	HVIO is controlled by Timer 1
			011	HVIO is controlled by Timer 2
			100	HVIO is controlled by Timer 3
			101	HVIO is controlled by Timer 4
			110	HVIO is controlled by HVIO+4 (inverted control; only available for bank 0)
111	HVIO is controlled by HVIO+4 (non-inverted control; only available for bank 0)			
2:0	IOnCC	R/W		HVIO configuration control:
			000	HVIO is off
			001	HVIO is configured as a HS-driver with slope control
			010	HVIO is configured as a LS-driver with slope control
			011	HVIO is configured as a wake-up input
			100	HVIO is configured as a HS-driver and wake-up input with slope control
			101	HVIO is configured as a HS-driver without slope control
			110	HVIO is configured as a LS-driver without slope control
111	HVIO is configured as a HS-driver and wake-up input without slope control			

[1] Addresses 30h to 33h for HVIO1 to HVIO4 respectively; addresses 40h to 43h for HVIO5 to HVIO8.

Table 35. Bank 0 (HVIO1 to HVIO4) wake-up threshold control register (address 34h)

Bit	Symbol	Access	Value	Description
7:1	reserved	R	-	
0	B0WTC	R/W		bank 0 wake-up threshold configuration:
			0	threshold is ratiometric to V_{BATHS1}
			1	threshold is absolute

Table 36. Bank 1 (HVIO5 to HVIO8) wake-up threshold control register (address 44h)

Bit	Symbol	Access	Value	Description
7:1	reserved	R	-	
0	B1WTC	R/W		bank 1 wake-up threshold configuration:
			0	threshold is ratiometric to V_{BATHS2}
			1	threshold is absolute

Table 37. Bank 0 wake-up status register (address 35h)

Bit	Symbol	Access	Value	Description
7:4	reserved	R	-	
3	IO4WLS	R		status of input voltage on HVIO4:
			0	the input voltage is below the selected wake-up threshold
			1	the input voltage is above the selected wake-up threshold
2	IO3WLS	R		status of input voltage on HVIO3:
			0	the input voltage is below the selected wake-up threshold
			1	the input voltage is above the selected wake-up threshold
1	IO2WLS	R		status of input voltage on HVIO2:
			0	the input voltage is below the selected wake-up threshold
			1	the input voltage is above the selected wake-up threshold
0	IO1WLS	R		status of input voltage on HVIO1:
			0	the input voltage is below the selected wake-up threshold
			1	the input voltage is above the selected wake-up threshold

Table 38. Bank 1 wake-up status register (address 45h)

Bit	Symbol	Access	Value	Description
7:4	reserved	R	-	
3	IO8WLS	R		status of input voltage on HVIO8:
			0	the input voltage is below the selected wake-up threshold
			1	the input voltage is above the selected wake-up threshold
2	IO7WLS	R		status of input voltage on HVIO7:
			0	the input voltage is below the selected wake-up threshold
			1	the input voltage is above the selected wake-up threshold
1	IO6WLS	R		status of input voltage on HVIO6:
			0	the input voltage is below the selected wake-up threshold
			1	the input voltage is above the selected wake-up threshold
0	IO5WLS	R		status of input voltage on HVIO5:
			0	the input voltage is below the selected wake-up threshold
			1	the input voltage is above the selected wake-up threshold

Table 39. Bank 0 driver status register (address 36h)

Bit	Symbol	Access	Value	Description
7:6	IO4DS	R		HVIO4 driver status:
			00	HVIO4 driver is ok
			01	open load on HVIO4
			10	short circuit on HVIO4
			11	HVIO4 driver is off
5:4	IO3DS	R		HVIO3 driver status:
			00	HVIO3 driver is ok
			01	open load on HVIO3
			10	short circuit on HVIO3
			11	HVIO3 driver is off
3:2	IO2DS	R		HVIO2 driver status:
			00	HVIO2 driver is ok
			01	open load on HVIO2
			10	short circuit on HVIO2
			11	HVIO2 driver is off
1:0	IO1DS	R		HVIO1 driver status:
			00	HVIO1 driver is ok
			01	open load on HVIO1
			10	short circuit on HVIO1
			11	HVIO1 driver is off

Table 40. Bank 1 driver status register (address 46h)

Bit	Symbol	Access	Value	Description
7:6	IO8DS	R		HVIO8 driver status:
			00	HVIO8 driver is ok
			01	open load on HVIO8
			10	short circuit on HVIO8
			11	HVIO8 driver is off
5:4	IO7DS	R		HVIO7 driver status:
			00	HVIO7 driver is ok
			01	open load on HVIO7
			10	short circuit on HVIO7
			11	HVIO7 driver is off
3:2	IO6DS	R		HVIO6 driver status:
			00	HVIO6 driver is ok
			01	open load on HVIO6
			10	short circuit on HVIO6
			11	HVIO6 driver is off

Table 40. Bank 1 driver status register (address 46h) ...continued

Bit	Symbol	Access	Value	Description
1:0	IO5DS	R		HVIO5 driver status:
			00	HVIO5 driver is ok
			01	open load on HVIO5
			10	short circuit on HVIO5
			11	HVIO5 driver is off

Table 41. Bank 0 short-circuit detection threshold control register (address 39h)

Bit	Symbol	Access	Value	Description
7:6	IO4SCTC	R/W		HVIO4 short-circuit detection threshold:
			00	$I_{th(det)sc}$ condition 00; see Table 90
			01	$I_{th(det)sc}$ condition 01; see Table 90
			10	$I_{th(det)sc}$ condition 10; see Table 90
			11	$I_{th(det)sc}$ condition 11; see Table 90
5:4	IO3SCTC	R/W		HVIO3 short-circuit threshold:
			00	$I_{th(det)sc}$ condition 00; see Table 90
			01	$I_{th(det)sc}$ condition 01; see Table 90
			10	$I_{th(det)sc}$ condition 10; see Table 90
			11	$I_{th(det)sc}$ condition 11; see Table 90
3:2	IO2SCTC	R/W		HVIO2 short-circuit threshold:
			00	$I_{th(det)sc}$ condition 00; see Table 90
			01	$I_{th(det)sc}$ condition 01; see Table 90
			10	$I_{th(det)sc}$ condition 10; see Table 90
			11	$I_{th(det)sc}$ condition 11; see Table 90
1:0	IO1SCTC	R/W		HVIO1 short-circuit threshold:
			00	$I_{th(det)sc}$ condition 00; see Table 90
			01	$I_{th(det)sc}$ condition 01; see Table 90
			10	$I_{th(det)sc}$ condition 10; see Table 90
			11	$I_{th(det)sc}$ condition 11; see Table 90

Table 42. Bank 0 open-load detection threshold control register (address 3Ah)

Bit	Symbol	Access	Value	Description
7:6	IO4OLTC	R/W		HVIO4 open-load threshold:
			00	$I_{th(det)open}$ condition 00; see Table 90
			01	$I_{th(det)open}$ condition 01; see Table 90
			10	$I_{th(det)open}$ condition 10; see Table 90
			11	$I_{th(det)open}$ condition 11; see Table 90
5:4	IO3OLTC	R/W		HVIO3 open-load threshold:
			00	$I_{th(det)open}$ condition 00; see Table 90
			01	$I_{th(det)open}$ condition 01; see Table 90
			10	$I_{th(det)open}$ condition 10; see Table 90
			11	$I_{th(det)open}$ condition 11; see Table 90

Table 42. Bank 0 open-load detection threshold control register (address 3Ah) ...continued

Bit	Symbol	Access	Value	Description
3:2	IO2OLTC	R/W		HVIO2 open-load threshold:
			00	$I_{th(det)open}$ condition 00; see Table 90
			01	$I_{th(det)open}$ condition 01; see Table 90
			10	$I_{th(det)open}$ condition 10; see Table 90
1:0	IO1OLTC	R/W		HVIO1 open-load threshold:
			00	$I_{th(det)open}$ condition 00; see Table 90
			01	$I_{th(det)open}$ condition 01; see Table 90
			10	$I_{th(det)open}$ condition 10; see Table 90
			11	$I_{th(det)open}$ condition 11; see Table 90

Table 43. Bank 1 short-circuit detection threshold control register (address 49h)

Bit	Symbol	Access	Value	Description
7:6	IO8SCTC	R/W		HVIO8 short-circuit threshold:
			00	$I_{th(det)sc}$ condition 00; see Table 90
			01	$I_{th(det)sc}$ condition 01; see Table 90
			10	$I_{th(det)sc}$ condition 10; see Table 90
5:4	IO7SCTC	R/W		HVIO7 short-circuit threshold:
			00	$I_{th(det)sc}$ condition 00; see Table 90
			01	$I_{th(det)sc}$ condition 01; see Table 90
			10	$I_{th(det)sc}$ condition 10; see Table 90
3:2	IO6SCTC	R/W		HVIO6 short-circuit threshold:
			00	$I_{th(det)sc}$ condition 00; see Table 90
			01	$I_{th(det)sc}$ condition 01; see Table 90
			10	$I_{th(det)sc}$ condition 10; see Table 90
1:0	IO5SCTC	R/W		HVIO5 short-circuit threshold:
			00	$I_{th(det)sc}$ condition 00; see Table 90
			01	$I_{th(det)sc}$ condition 01; see Table 90
			10	$I_{th(det)sc}$ condition 10; see Table 90
			11	$I_{th(det)sc}$ condition 11; see Table 90

Table 44. Bank 1 open-load detection threshold control register (address 4Ah)

Bit	Symbol	Access	Value	Description
7:6	IO8OLTC	R/W		HVIO8 open-load threshold:
			00	$I_{th(det)open}$ condition 00; see Table 90
			01	$I_{th(det)open}$ condition 01; see Table 90
			10	$I_{th(det)open}$ condition 10; see Table 90
			11	$I_{th(det)open}$ condition 11; see Table 90

Table 44. Bank 1 open-load detection threshold control register (address 4Ah) ...continued

Bit	Symbol	Access	Value	Description
5:4	IO7OLTC	R/W		HVIO7 open-load threshold:
			00	$I_{th(det)open}$ condition 00; see Table 90
			01	$I_{th(det)open}$ condition 01; see Table 90
			10	$I_{th(det)open}$ condition 10; see Table 90
3:2	IO6OLTC	R/W		HVIO6 open-load threshold:
			00	$I_{th(det)open}$ condition 00; see Table 90
			01	$I_{th(det)open}$ condition 01; see Table 90
			10	$I_{th(det)open}$ condition 10; see Table 90
1:0	IO5OLTC	R/W		HVIO5 open-load threshold:
			00	$I_{th(det)open}$ condition 00; see Table 90
			01	$I_{th(det)open}$ condition 01; see Table 90
			10	$I_{th(det)open}$ condition 10; see Table 90
			11	$I_{th(det)open}$ condition 11; see Table 90

Table 45. HVIO high-side driver control register (address 71h)

This table is located in non-volatile memory with restricted write access.

Bit	Symbol	Access	Value	Description
7	IO8HOC	R/W		HVIO8 high-side driver control:
			0 ^[1]	HVIO8 high-side driver is controlled by the setting in the HVIO8 control register
			1	HVIO8 high-side driver is off, regardless of the setting in the HVIO8 control register
6	IO7HOC	R/W		HVIO7 high-side driver control:
			0 ^[1]	HVIO7 high-side driver is controlled by the setting in the HVIO7 control register
			1	HVIO7 high-side driver is off, regardless of the setting in the HVIO7 control register
5	IO6HOC	R/W		HVIO6 high-side driver control:
			0 ^[1]	HVIO6 high-side driver is controlled by the setting in the HVIO6 control register
			1	HVIO6 high-side driver is off, regardless of the setting in the HVIO6 control register
4	IO5HOC	R/W		HVIO5 high-side driver control:
			0 ^[1]	HVIO5 high-side driver is controlled by the setting in the HVIO5 control register
			1	HVIO5 high-side driver is off, regardless of the setting in the HVIO5 control register
3	IO4HOC	R/W		HVIO4 high-side driver control:
			0 ^[1]	HVIO4 high-side driver is controlled by the setting in the HVIO4 control register
			1	HVIO4 high-side driver is off, regardless of the setting in the HVIO4 control register

Table 45. HVIO high-side driver control register (address 71h) ...continued*This table is located in non-volatile memory with restricted write access.*

Bit	Symbol	Access	Value	Description
2	IO3HOC	R/W		HVIO3 high-side driver control:
			0 ^[1]	HVIO3 high-side driver is controlled by the setting in the HVIO3 control register
			1	HVIO3 high-side driver is off, regardless of the setting in the HVIO3 control register
1	IO2HOC	R/W		HVIO2 high-side driver control:
			0 ^[1]	HVIO2 high-side driver is controlled by the setting in the HVIO2 control register
			1	HVIO2 high-side driver is off, regardless of the setting in the HVIO2 control register
0	IO1HOC	R/W		HVIO1 high-side driver control:
			0 ^[1]	HVIO1 high-side driver is controlled by the setting in the HVIO1 control register
			1	HVIO1 high-side driver is off, regardless of the setting in the HVIO1 control register

[1] Factory preset value.

Table 46. HVIO low-side driver control register (address 72h)*This table is located in non-volatile memory with restricted write access.*

Bit	Symbol	Access	Value	Description
7	IO8LOC	R/W		HVIO8 low-side driver control:
			0 ^[1]	HVIO8 low-side driver is controlled by the setting in the HVIO8 control register
			1	HVIO8 low-side driver is off, regardless of the setting in the HVIO8 control register
6	IO7LOC	R/W		HVIO7 low-side driver control:
			0 ^[1]	HVIO7 low-side driver is controlled by the setting in the HVIO7 control register
			1	HVIO7 low-side driver is off, regardless of the setting in the HVIO7 control register
5	IO6LOC	R/W		HVIO6 low-side driver control:
			0 ^[1]	HVIO6 low-side driver is controlled by the setting in the HVIO6 control register
			1	HVIO6 low-side driver is off, regardless of the setting in the HVIO6 control register
4	IO5LOC	R/W		HVIO5 low-side driver control:
			0 ^[1]	HVIO5 low-side driver is controlled by the setting in the HVIO5 control register
			1	HVIO5 low-side driver is off, regardless of the setting in the HVIO5 control register

Table 46. HVIO low-side driver control register (address 72h) ...continued
 This table is located in non-volatile memory with restricted write access.

Bit	Symbol	Access	Value	Description
3	IO4LOC	R/W		HVIO4 low-side driver control:
			0 ^[1]	HVIO4 low-side driver is controlled by the setting in the HVIO4 control register
			1	HVIO4 low-side driver is off, regardless of the setting in the HVIO4 control register
2	IO3LOC	R/W		HVIO3 low-side driver control:
			0 ^[1]	HVIO3 low-side driver is controlled by the setting in the HVIO3 control register
			1	HVIO3 low-side driver is off, regardless of the setting in the HVIO3 control register
1	IO2LOC	R/W		HVIO2 low-side driver control:
			0 ^[1]	HVIO2 low-side driver is controlled by the setting in the HVIO2 control register
			1	HVIO2 low-side driver is off, regardless of the setting in the HVIO2 control register
0	IO1LOC	R/W		HVIO1 low-side driver control:
			0 ^[1]	HVIO1 low-side driver is controlled by the setting in the HVIO1 control register
			1	HVIO1 low-side driver is off, regardless of the setting in the HVIO1 control register

[1] Factory preset value.

7.11 Timer control (not applicable to UJA113xFD/0 variants)

The UJA113x contains 4 timers. Each timer can be assigned to any of the HVIOs. Up to four configuration options are available: two Autonomous options and two Slave options. If an Autonomous option is selected (PWM mode or Timer mode), the timer period is determined by the dedicated timer period control bits TnPC. If a Slave option is selected (Synchronous timer mode or Synchronous follower mode), the timer period is inherited from a timer further up the chain, as described in [Table 47](#). Timer 1 acts as a master timer and, therefore, has no slave option.

The timer mode is selected via control bits TnMC (see [Table 48](#) to [Table 54](#)). The options available are described in [Table 47](#). In an Autonomous mode, the duty cycle is determined by the setting of bits TnDCC (see [Table 49](#) to [Table 55](#)). In Timer mode, the activation of an assigned HVIO is delayed by one period to allow for synchronization with other timers.

Remark: When HVIO3 is configured as a limp home output (IO3SFC = 1), Timer 3 provides the clock signal (100 Hz 10 % PWM; see [Section 7.10.6](#)). Timer 3 is not available for any other purpose. Timer 3 control settings are ignored ([Table 52](#) and [Table 53](#)). HVIOs configured to be controlled by Timer 3 remain off. Similarly, Timer 4 is dedicated to HVIO4 when it is configured as a limp home output and cannot be used for any other purpose (1.25 Hz 50 % PWM signal).

Table 47. Timer configuration options

Mode	Mode type	TnMC	Description
PWM	Autonomous	00	The duty cycle set via TnDCC is relative to the timer period. The period is determined by the dedicated timer period control bits (TnPC). This configuration option can be used for LED dimming.
Timer	Autonomous	01	The pulse width is a multiple of 100 μ s regardless of the selected period. If the on-time is longer than the selected period, the timer is always on. The period is determined by the dedicated timer period control bits (TnPC). This option is useful for generating short pulses with long periods, e.g. for switch biasing or safety heartbeat signals.
Synchronous timer	Slave	10	The pulse length is a multiple of 100 μ s. The pulse is triggered synchronously with the pulse of Timer 1. So the timer period is inherited from Timer 1, regardless of the setting of TnPC. If the pulse length is longer than the period of Timer 1, the timer is always on. This mode can be used for generating synchronized pulses of different lengths. Since Timer 1 is the master timer, this option is only available for Timers 2 to 4. Note that the slave timer is triggered even when Timer 1 is operating at a duty cycle of 0 %.
Synchronous follower	Slave	11	The pulse length is a multiple of 100 μ s. The pulse of Timer n is triggered at the end of the pulse of Timer n – 1. The period is also inherited from Timer n – 1 (if Timer n – 1 is also running in a Slave mode, the period is inherited from Timer n – 2, and so on). So the pulse of Timer 3 is triggered at the end of the Timer 2 pulse and the period is also inherited from Timer 2 (assuming Timer 2 is not running in a Slave mode). This mode is useful for generating consecutive pulses. This option is only available for Timers 2 to 4. Note that the slave timer is triggered even when Timer 1 is operating at a duty cycle of 0 %.

7.11.1 Timer control and status registers

Table 48. Timer 1 control register (address 50h)

Bit	Symbol	Access	Value	Description
7:6	reserved	R	-	
5:2	T1PC	R/W		Timer 1 period:
			0000	4 ms
			0001	8 ms
			0010	20 ms
			0011	30 ms
			0100	50 ms
			0101	100 ms
			0110	200 ms
			0111	400 ms
			1000	800 ms
			1001	1 s
			1010	2 s
1011	4 s			
1	reserved	R	-	
0	T1MC	R/W		Timer 1 mode control:
			0	Timer 1 is in PWM mode; on-time = $T1DCC \times T1PC / 255$
			1	Timer 1 is in Timer mode; on-time = $T1DCC \times t_{w(base)tmr} \mu\text{s}$; period defined by T1PC

Table 49. Timer 1 duty cycle control register (address 51h)

Bit	Symbol	Access	Value	Description
7:0	T1DCC	R/W	xxxxxxx	duty cycle = $T1DCC / 255$

Table 50. Timer 2 control register (address 52h)

Bit	Symbol	Access	Value	Description
7:6	reserved	R	-	
5:2	T2PC	R/W		Timer 2 period:
			0000	4 ms
			0001	8 ms
			0010	20 ms
			0011	30 ms
			0100	50 ms
			0101	100 ms
			0110	200 ms
			0111	400 ms
			1000	800 ms
			1001	1 s
			1010	2 s
1011	4 s			

Table 50. Timer 2 control register (address 52h) ...continued

Bit	Symbol	Access	Value	Description
0:1	T2MC	R/W		Timer 2 mode control:
			00	Timer 2 is in PWM mode; on-time = $T2DCC \times T2PC / 255$
			01	Timer 2 is in Timer mode; on-time = $T2DCC \times t_{w(base)tmr} \mu S$; period defined by T2PC
			10	Timer 2 pulse is triggered at the start of Timer 1 pulse (master-slave mode); on-time = $T2DCC \times t_{w(base)tmr} \mu S$
			11	Timer 2 pulse is triggered at the end of Timer 1 pulse (follower mode); on-time = $T2DCC \times t_{w(base)tmr} \mu S$

Table 51. Timer 2 duty cycle control register (address 53h)

Bit	Symbol	Access	Value	Description
7:0	T2DCC	R/W	xxxxxxx	duty cycle = $T2DCC / 255$

Table 52. Timer 3 control register (address 54h)

Bit	Symbol	Access	Value	Description
7:6	reserved	R	-	
5:2	T3PC	R/W		Timer 3 period:
			0000	4 ms
			0001	8 ms
			0010	20 ms
			0011	30 ms
			0100	50 ms
			0101	100 ms
			0110	200 ms
			0111	400 ms
			1000	800 ms
			1001	1 s
			1010	2 s
1011	4 s			
0:1	T3MC	R/W		Timer 3 mode control:
			00	Timer 3 is in PWM mode; on-time = $T3DCC \times T3PC / 255$
			01	Timer 3 is in Timer mode; on-time = $T3DCC \times t_{w(base)tmr} \mu S$; period defined by T3PC
			10	Timer 3 pulse is triggered at the start of Timer 1 pulse (master-slave mode); on-time = $T3DCC \times t_{w(base)tmr} \mu S$
			11	Timer 3 pulse is triggered at the end of Timer 2 pulse (follower mode); on-time = $T3DCC \times t_{w(base)tmr} \mu S$

Table 53. Timer 3 duty cycle control register (address 55h)

Bit	Symbol	Access	Value	Description
7:0	T3DCC	R/W	xxxxxxx	duty cycle = $T3DCC / 255$

Table 54. Timer 4 control register (address 56h)

Bit	Symbol	Access	Value	Description
7:6	reserved	R	-	
5:2	T4PC	R/W		Timer 4 period:
			0000	4 ms
			0001	8 ms
			0010	20 ms
			0011	30 ms
			0100	50 ms
			0101	100 ms
			0110	200 ms
			0111	400 ms
			1000	800 ms
			1001	1 s
			1010	2 s
1011	4 s			
0:1	T4MC	R/W		Timer 4 mode control:
			00	Timer 4 is in PWM mode; on-time = $T4DCC \times T4PC / 255$
			01	Timer 4 is in Timer mode; on-time = $T4DCC \times t_{w(base)tmr} \mu\text{s}$; period defined by T4PC
			10	Timer 4 pulse is triggered at the start of Timer 1 pulse (master-slave mode); on-time = $T4DCC \times t_{w(base)tmr} \mu\text{s}$
			11	Timer 4 pulse is triggered at the end of Timer 3 pulse (follower mode); on-time = $T4DCC \times t_{w(base)tmr} \mu\text{s}$

Table 55. Timer 4 duty cycle control register (address 57h)

Bit	Symbol	Access	Value	Description
7:0	T4DCC	R/W	xxxxxxx	duty cycle = $T4DCC / 255$

7.12 Interrupt mechanism and wake-up function

The SBC interrupt mechanism alerts the microcontroller to specific events or changes of state via the interrupt pins, INTN1 and INTN2. Most interrupts can be enabled/disabled via dedicated interrupt enable bits. If an event occurs while the associated interrupt is enabled, pin INTN1 and, depending on the interrupt source, pin INTN2 are forced LOW. If the device is in Sleep mode when the interrupt is generated, the SBC wakes up and enters Reset Mode. The SBC does not distinguish between wake-up and interrupt events. All wake-up events (LIN, CAN and HVIO) generate interrupt requests and all interrupts trigger a wake-up event when the UJA113x is in a low-power mode. When the SBC wakes up in response to an interrupt or wake-up event, the interrupt pin(s) will be LOW to signal to the microcontroller that an interrupt needs to be processed.

Pins INTN1 and INTN2 are digital open-drain active-LOW outputs that should be connected to the microcontroller. External pull-up resistors to V1 are needed to pull the interrupt pins HIGH when no interrupt is pending. Pin INTN1 is always driven LOW when

an interrupt is pending. Pin INTN2 is assigned to a critical subset of interrupts that require immediate action, such as undervoltage or overtemperature warnings. So INTN2 can be used to assign priorities to interrupts via software.

An interrupt status bit is associated with each interrupt source to indicate whether an interrupt is pending. The interrupt status bits are located in [Table 58](#) to [Table 64](#). When an interrupt is generated, the microcontroller needs to poll these registers to determine the source of the interrupt. An additional Global interrupt status register ([Table 57](#)) is provided to help speed up this process. The microcontroller can access this register to determine the type of interrupt generated (system, supply, transceiver, bank 0 or bank 1) and then go directly to the relevant status register, minimizing access times.

Once the interrupt source has been identified, the relevant status bit should be cleared (set to 0) by writing 1 to the relevant bit - writing 0 will have no effect. A number of status bits can be cleared in a single write operation by writing 1 to all relevant bits. The interrupt pins are released (go HIGH) when all interrupt status bits have been cleared.

7.12.1 Interrupt delay

If interrupts occur very frequently, they can have a significant impact on the software processing time (because pins INTN1/INTN2 are repeatedly driven LOW, requiring a response from the microcontroller each time). The UJA113x incorporates an interrupt delay timer to limit the disturbance to the software.

A timer is started and pin INTN1 is released when one or more interrupt status bits are cleared. A number of interrupts may be generated and captured while the timer is running and pin INTN1 remains HIGH. When the timer expires after $t_{to(int)}$, pin INTN1 goes LOW if one or more interrupts are pending. Note that the interrupt status registers can be read and cleared at any time, including while the timer is running and INTN1 is HIGH.

The interrupt delay timer is stopped immediately if pin RSTN goes LOW (as happens when the SBC enters Reset, Sleep, Overload and Off modes). The timer has no effect on pin INTN2. This pin goes LOW as soon as an associated interrupt is generated to allow the microcontroller to react as quickly as possible.

7.12.2 Sleep mode protection

The interrupt (wake-up) function is critical when the UJA113x is in Sleep mode because the SBC will only leave Sleep mode in response to an interrupt request. To avoid deadlocks, the SBC distinguishes between regular and diagnostic interrupts (see [Section 7.12.3](#)). Regular interrupts are generated by bus (CAN, LIN) and local (HVIO) wake-up events; diagnostic interrupts detect failure/error conditions or state changes. At least one regular interrupt must be enabled before the UJA113x can switch to Sleep mode. Any attempt to enter Sleep mode while all the regular interrupts are disabled triggers a system reset.

Another condition that must be satisfied before the UJA113x can switch to Sleep mode is that all interrupt status bits must be cleared (no interrupt pending). If an SPI command to go to Sleep mode (MC = 001) is issued while an interrupt is pending, the SBC immediately switches to Reset mode. This condition applies to all interrupts (regular and diagnostic).

7.12.3 Interrupt sources

Table 56 provides an overview of the interrupts recognized by the UJA113x. The events that trigger each interrupt are described. In addition, the interrupt type ('regular' or 'diagnostic') is specified along with the associated interrupt pin(s) (INTN1 or both INTN1 and INTN2).

Most interrupts can be enabled and disabled via the interrupt enable registers (Table 65 to Table 71). The following interrupts do not have associated interrupt enable bits and are always enabled: WDI, PNFDEI, POSI, OVSDI.

Note that bus wake-up events (CAN, LIN1 and LIN2) also cause the dedicated RXD pins (RXDC, RXDL1 and RXDL2) to go LOW. Pin RXDx is released when the relevant interrupt status bit (CWI, LWI1 or LWI2) is cleared.

Table 56. Interrupt sources

Symbol	Description	Type	Pin	Source
CFI	CAN failure interrupt	diagnostic	INTN1	Status bit VCS and/or status bit CFS is set to 1.
CWI	CAN wake-up interrupt	regular	INTN1	A CAN wake-up event was detected while the transceiver was not in Active mode.
CBSI	CAN-bus silence interrupt	diagnostic	INTN1	The CAN-bus has been silent for $t > t_{to(silence)}$.
LWIn	LINn wake-up interrupt	regular	INTN1	A wake-up event was detected at LINn while the transceiver was not in Active mode.
WDI	watchdog failure interrupt	diagnostic	INTN1	The watchdog overflowed in Timeout mode. If the watchdog overflows while a WDI is pending, a reset is performed. Note that this interrupt cannot be deactivated.
OTWI	overtemperature warning interrupt	diagnostic	INTN1, INTN2	The global chip temperature has exceeded the over-temperature warning threshold.
PNFDEI	partial networking frame detect error interrupt	diagnostic	INTN1	A CAN error frame was detected by the partial networking receiver.
POSI	power-on status interrupt	diagnostic	INTN1	The SBC has left Off Mode; interrupt is always enabled.
SPIFI	SPI failure interrupt	diagnostic	INTN1	This interrupt is triggered by the following events: <ul style="list-style-type: none"> • illegal WMC code • illegal NWP code • illegal MC code • wrong SPI clock count (only 16-, 24- and 32-bit commands are supported) • write access to a locked register
V1UI	V1 undervoltage interrupt	diagnostic	INTN1, INTN2	V1 voltage dropped below the 90 % undervoltage threshold while V1 was active (no interrupt triggered in Sleep mode because V1 is off). This interrupt is independent of the V1RTC bit setting.
VEXTUI	V2 undervoltage interrupt	diagnostic	INTN1	V2/VEXT dropped below the 90 % undervoltage threshold.
VEXTOI	V2 overvoltage interrupt	diagnostic	INTN1	V2/VEXT above the 110 % overvoltage threshold.
BMUI	battery monitor undervoltage interrupt	diagnostic	INTN1, INTN2	The voltage measured at the active battery monitoring source (pin BAT or pin BATSENSE) dropped below the selected undervoltage threshold.

Table 56. Interrupt sources ...continued

Symbol	Description	Type	Pin	Source
BMOI	battery monitor overvoltage interrupt	diagnostic	INTN1, INTN2	The voltage measured at the active battery monitoring source (pin BAT or pin BATSENSE) has risen above the selected overvoltage threshold.
OVSDI	overvoltage shut-down interrupt	diagnostic	INTN1, INTN2	A battery overvoltage will cause the SBC to enter Overload Mode; interrupt is always enabled.
SMPSSI	SMPS status interrupt	diagnostic	INTN1, INTN2	The state of bit SMPSS has changed (see Section 7.8.4.1)
IOnOLI	HVION open load interrupt	diagnostic	INTN1	An open load condition was detected at HVION while the high-side or low-side driver was active.
IOnSCI	HVION short circuit interrupt	diagnostic	INTN1	A short-circuit condition was detected at HVION while the high-side or low-side driver was active.
IOnREI	HVION rising edge interrupt	regular	INTN1	A rising edge wake-up signal was detected at pin HVION when configured as wake input.
IOnFEI	HVION falling edge interrupt	regular	INTN1	A falling edge wake-up signal was detected at pin HVION when configured as wake input.

7.12.4 Interrupt registers

Table 57. Global interrupt status register (address 60h)

Bit	Symbol	Access	Value	Description
7	reserved	R	-	
6	B1FIS ^[1]	R	0	no pending interrupt in the bank 1 fail interrupt status register
			1	pending interrupt in the bank 1 fail interrupt status register
5	B1WIS ^[1]	R	0	no pending interrupt in bank 1 wake-up interrupt status register
			1	pending interrupt in the bank 1 wake-up interrupt status register
4	B0FIS ^[2]	R	0	no pending interrupt in the bank 0 fail interrupt status register
			1	pending interrupt in the bank 0 fail interrupt status register
3	B0WIS ^[2]	R	0	no pending interrupt in bank 0 wake-up interrupt status register
			1	pending interrupt in the bank 0 wake-up interrupt status register
2	TRXIS	R	0	no pending interrupt in the Transceiver interrupt status register
			1	pending interrupt in the Transceiver interrupt status register
1	SUPIS	R	0	no pending interrupt in the Supply interrupt status register
			1	pending interrupt in the Supply interrupt status register
0	SYSIS	R	0	no pending interrupt in the System interrupt status register
			1	pending interrupt in the System interrupt status register

[1] Reserved in UJA113xFD/x.

[2] Reserved in UJA113xFD/0.

Table 58. System interrupt status register (address 61h)

Bit	Symbol	Access	Value	Description
7:6	reserved	R	-	
5	OVSDI ^[1]	R/W	0	no overvoltage shut-down interrupt pending
			1	overvoltage shut-down interrupt pending

Table 58. System interrupt status register (address 61h) ...continued

Bit	Symbol	Access	Value	Description
4	POS ^[1]	R/W	0	no power-on status interrupt pending
			1	power-on status interrupt pending
3	reserved	R	-	
2	OTWI	R/W	0	no overtemperature warning interrupt pending
			1	overtemperature warning interrupt pending
1	SPIFI	R/W	0	no SPI failure interrupt pending
			1	SPI failure interrupt pending
0	WDI ^[1]	R/W	0	no watchdog failure interrupt pending
			1	watchdog failure interrupt pending

[1] Interrupt always enabled.

Table 59. Supply interrupt status register (address 62h)

Bit	Symbol	Access	Value	Description
7:6	reserved	R	-	
5	SMPSSI	R/W	0	no SMPS status interrupt pending
			1	SMPS status interrupt pending (value of bit SMPSS has changed; see Section 7.8.4.1)
4	BMOI	R/W	0	no battery monitor overvoltage interrupt pending
			1	battery monitor overvoltage interrupt pending
3	BMUI	R/W	0	no battery monitor undervoltage interrupt pending
			1	battery monitor undervoltage interrupt pending
2	VEXTOI	R/W	0	no VEXT overvoltage interrupt pending
			1	VEXT overvoltage interrupt pending
1	VEXTUI	R/W	0	no VEXT undervoltage interrupt pending
			1	VEXT undervoltage interrupt pending
0	V1UI	R/W	0	no V1 undervoltage interrupt pending
			1	V1 undervoltage interrupt pending

Table 60. Transceiver interrupt status register (address 63h)

Bit	Symbol	Access	Value	Description
7:6	reserved	R	-	
5	PNFDEI	R/W	0	no partial networking frame detection error detected
			1	partial networking frame detection error detected
4	CBSI	R/W	0	no CAN-bus silence interrupt pending
			1	CAN-bus silence interrupt pending - CAN-bus silent for at least $t > t_{to(silence)}$
3	LWI2 ^[1]	R/W	0	no LIN2 wake-up interrupt pending
			1	LIN2 wake-up interrupt pending
2	LWI1	R/W	0	no LIN1 wake-up interrupt pending
			1	LIN1 wake-up interrupt pending

Table 60. Transceiver interrupt status register (address 63h) ...continued

Bit	Symbol	Access	Value	Description
1	CFI	R/W	0	no CAN failure interrupt pending
			1	CAN failure interrupt pending
0	CWI	R/W	0	no CAN wake-up interrupt pending
			1	CAN wake-up interrupt pending

[1] UJA1132 and UJA1136 only; bit 3 is reserved in the UJA1131 and UJA1135.

Table 61. Bank 0 wake-up interrupt status register (address 64h)

Not available in UJA113xFD/0.

Bit	Symbol	Access	Value	Description
7	IO4FEI	R/W	0	no HVIO4 falling edge interrupt pending
			1	HVIO4 falling edge interrupt pending
6	IO4REI	R/W	0	no HVIO4 rising edge interrupt pending
			1	HVIO4 rising edge interrupt pending
5	IO3FEI	R/W	0	no HVIO3 falling edge interrupt pending
			1	HVIO3 falling edge interrupt pending
4	IO3REI	R/W	0	no HVIO3 rising edge interrupt pending
			1	HVIO3 rising edge interrupt pending
3	IO2FEI	R/W	0	no HVIO2 falling edge interrupt pending
			1	HVIO2 falling edge interrupt pending
2	IO2REI	R/W	0	no HVIO2 rising edge interrupt pending
			1	HVIO2 rising edge interrupt pending
1	IO1FEI	R/W	0	no HVIO1 falling edge interrupt pending
			1	HVIO1 falling edge interrupt pending
0	IO1REI	R/W	0	no HVIO1 rising edge interrupt pending
			1	HVIO1 rising edge interrupt pending

Table 62. Bank 0 fail interrupt status register (address 65h)

Not available in UJA113xFD/0.

Bit	Symbol	Access	Value	Description
7	IO4SCI	R/W	0	no HVIO4 short circuit interrupt pending
			1	HVIO4 short circuit interrupt pending
6	IO4OLI	R/W	0	no HVIO4 open load interrupt pending
			1	HVIO4 open load interrupt pending
5	IO3SCI	R/W	0	no HVIO3 short circuit interrupt pending
			1	HVIO3 short circuit interrupt pending
4	IO3OLI	R/W	0	no HVIO3 open load interrupt pending
			1	HVIO3 open load interrupt pending
3	IO2SCI	R/W	0	no HVIO2 short circuit interrupt pending
			1	HVIO2 short circuit interrupt pending
2	IO2OLI	R/W	0	no HVIO2 open load interrupt pending
			1	HVIO2 open load interrupt pending

Table 62. Bank 0 fail interrupt status register (address 65h) ...continued
 Not available in UJA113xFD/0.

Bit	Symbol	Access	Value	Description
1	IO1SCI	R/W	0	no HVIO1 short circuit interrupt pending
			1	HVIO1 short circuit interrupt pending
0	IO1OLI	R/W	0	no HVIO1 open load interrupt pending
			1	HVIO1 open load interrupt pending

Table 63. Bank 1 wake-up interrupt status register (address 66h)
 Not available in UJA113xFD/x.

Bit	Symbol	Access	Value	Description
7	IO8FEI	R/W	0	no HVIO8 falling edge interrupt pending
			1	HVIO8 falling edge interrupt pending
6	IO8REI	R/W	0	no HVIO8 rising edge interrupt pending
			1	HVIO8 rising edge interrupt pending
5	IO7FEI	R/W	0	no HVIO7 falling edge interrupt pending
			1	HVIO7 falling edge interrupt pending
4	IO7REI	R/W	0	no HVIO7 rising edge interrupt pending
			1	HVIO7 rising edge interrupt pending
3	IO6FEI	R/W	0	no HVIO6 falling edge interrupt pending
			1	HVIO6 falling edge interrupt pending
2	IO6REI	R/W	0	no HVIO6 rising edge interrupt pending
			1	HVIO6 rising edge interrupt pending
1	IO5FEI	R/W	0	no HVIO5 falling edge interrupt pending
			1	HVIO5 falling edge interrupt pending
0	IO5REI	R/W	0	no HVIO5 rising edge interrupt pending
			1	HVIO5 rising edge interrupt pending

Table 64. Bank 1 fail interrupt status register (address 67h)
 Not available in UJA113xFD/x.

Bit	Symbol	Access	Value	Description
7	IO8SCI	R/W	0	no HVIO8 short circuit interrupt pending
			1	HVIO8 short circuit interrupt pending
6	IO8OLI	R/W	0	no HVIO8 open load interrupt pending
			1	HVIO8 open load interrupt pending
5	IO7SCI	R/W	0	no HVIO7 short circuit interrupt pending
			1	HVIO7 short circuit interrupt pending
4	IO7OLI	R/W	0	no HVIO7 open load interrupt pending
			1	HVIO7 open load interrupt pending
3	IO6SCI	R/W	0	no HVIO6 short circuit interrupt pending
			1	HVIO6 short circuit interrupt pending
2	IO6OLI	R/W	0	no HVIO6 open load interrupt pending
			1	HVIO6 open load interrupt pending

Table 64. Bank 1 fail interrupt status register (address 67h) ...continued
 Not available in UJA113xFD/x.

Bit	Symbol	Access	Value	Description
1	IO5SCI	R/W	0	no HVIO5 short circuit interrupt pending
			1	HVIO5 short circuit interrupt pending
0	IO5OLI	R/W	0	no HVIO5 open load interrupt pending
			1	HVIO5 open load interrupt pending

Table 65. System interrupt enable register (address 04h)

Bit	Symbol	Access	Value	Description
7:3	reserved	R	-	
2	OTWIE	R/W	0	overtemperature warning interrupt disabled
			1	overtemperature warning interrupt enabled
1	SPIFIE	R/W	0	SPI failure interrupt disabled
			1	SPI failure interrupt enabled
0	reserved	R	-	

Table 66. Supply interrupt enable (address 1Ch)

Bit	Symbol	Access	Value	Description
7:6	reserved	R	-	
5	SMPSSIE	R/W	0	SMPS status interrupt disabled
			1	SMPS status interrupt enabled
4	BMOIE	R/W	0	battery monitor overvoltage interrupt disabled
			1	battery monitor overvoltage interrupt enabled
3	BMUIE	R/W	0	battery monitor undervoltage interrupt disabled
			1	battery monitor undervoltage interrupt enabled
2	VEXTOIE	R/W	0	VEXT overvoltage interrupt disabled
			1	VEXT overvoltage interrupt enabled
1	VEXTUIE	R/W	0	VEXT undervoltage interrupt disabled
			1	VEXT undervoltage interrupt enabled
0	V1UIE	R/W	0	V1 undervoltage interrupt disabled
			1	V1 undervoltage interrupt enabled

Table 67. Transceiver interrupt enable register (address 23h)

Bit	Symbol	Access	Value	Description
7:5	reserved	R	-	
4	CBSIE	R/W	0	CAN-bus silence interrupt disabled
			1	CAN-bus silence interrupt enabled
3	LWI2E ^[1]	R/W	0	LIN2 wake-up interrupt disabled
			1	LIN2 wake-up interrupt enabled
2	LWI1E	R/W	0	LIN1 wake-up interrupt disabled
			1	LIN1 wake-up interrupt enabled

Table 67. Transceiver interrupt enable register (address 23h) ...continued

Bit	Symbol	Access	Value	Description
1	CFIE	R/W	0	CAN failure interrupt disabled
			1	CAN failure interrupt enabled
0	CWIE	R/W	0	CAN wake-up interrupt disabled
			1	CAN wake-up interrupt enabled

[1] UJA1132 and UJA1136 only; bit 3 is reserved in the UJA1131 and UJA1135.

Table 68. Bank 0 wake-up interrupt enable register (address 37h)

Not available in UJA113xFD/0.

Bit	Symbol	Access	Value	Description
7	IO4FEIE	R/W	0	HVIO4 falling edge interrupt disabled
			1	HVIO4 falling edge interrupt enabled
6	IO4REIE	R/W	0	HVIO4 rising edge interrupt disabled
			1	HVIO4 rising edge interrupt enabled
5	IO3FEIE	R/W	0	HVIO3 falling edge interrupt disabled
			1	HVIO3 falling edge interrupt enabled
4	IO3REIE	R/W	0	HVIO3 rising edge interrupt disabled
			1	HVIO3 rising edge interrupt enabled
3	IO2FEIE	R/W	0	HVIO2 falling edge interrupt disabled
			1	HVIO2 falling edge interrupt enabled
2	IO2REIE	R/W	0	HVIO2 rising edge interrupt disabled
			1	HVIO2 rising edge interrupt enabled
1	IO1FEIE	R/W	0	HVIO1 falling edge interrupt disabled
			1	HVIO1 falling edge interrupt enabled
0	IO1REIE	R/W	0	HVIO1 rising edge interrupt disabled
			1	HVIO1 rising edge interrupt enabled

Table 69. Bank 0 fail interrupt enable register (address 38h)

Not available in UJA113xFD/0.

Bit	Symbol	Access	Value	Description
7	IO4SCIE	R/W	0	HVIO4 short circuit interrupt disabled
			1	HVIO4 short circuit interrupt enabled
6	IO4OLIE	R/W	0	HVIO4 open load interrupt enabled
			1	HVIO4 open load interrupt disabled
5	IO3SCIE	R/W	0	HVIO3 short circuit interrupt disabled
			1	HVIO3 short circuit interrupt enabled
4	IO3OLIE	R/W	0	HVIO3 open load interrupt enabled
			1	HVIO3 open load interrupt disabled
3	IO2SCIE	R/W	0	HVIO2 short circuit interrupt disabled
			1	HVIO2 short circuit interrupt enabled
2	IO2OLIE	R/W	0	HVIO2 open load interrupt enabled
			1	HVIO2 open load interrupt disabled

Table 69. Bank 0 fail interrupt enable register (address 38h) ...continued
 Not available in UJA113xFD/0.

Bit	Symbol	Access	Value	Description
1	IO1SCIE	R/W	0	HVIO1 short circuit interrupt disabled
			1	HVIO1 short circuit interrupt enabled
0	IO1OLIE	R/W	0	HVIO1 open load interrupt enabled
			1	HVIO1 open load interrupt disabled

Table 70. Bank 1 wake-up interrupt enable register (address 47h)
 Not available in UJA113xFD/x.

Bit	Symbol	Access	Value	Description
7	IO8FEIE	R/W	0	HVIO8 falling edge interrupt disabled
			1	HVIO8 falling edge interrupt enabled
6	IO8REIE	R/W	0	HVIO8 rising edge interrupt disabled
			1	HVIO8 rising edge interrupt enabled
5	IO7FEIE	R/W	0	HVIO7 falling edge interrupt disabled
			1	HVIO7 falling edge interrupt enabled
4	IO7REIE	R/W	0	HVIO7 rising edge interrupt disabled
			1	HVIO7 rising edge interrupt enabled
3	IO6FEIE	R/W	0	HVIO6 falling edge interrupt disabled
			1	HVIO6 falling edge interrupt enabled
2	IO6REIE	R/W	0	HVIO6 rising edge interrupt disabled
			1	HVIO6 rising edge interrupt enabled
1	IO5FEIE	R/W	0	HVIO5 falling edge interrupt disabled
			1	HVIO5 falling edge interrupt enabled
0	IO5REIE	R/W	0	HVIO5 rising edge interrupt disabled
			1	HVIO5 rising edge interrupt enabled

Table 71. Bank 1 fail interrupt enable register (address 48h)
 Not available in UJA113xFD/x.

Bit	Symbol	Access	Value	Description
7	IO8SCIE	R/W	0	HVIO8 short circuit interrupt disabled
			1	HVIO8 short circuit interrupt enabled
6	IO8OLIE	R/W	0	HVIO8 open load interrupt enabled
			1	HVIO8 open load interrupt disabled
5	IO7SCIE	R/W	0	HVIO7 short circuit interrupt disabled
			1	HVIO7 short circuit interrupt enabled
4	IO7OLIE	R/W	0	HVIO7 open load interrupt enabled
			1	HVIO7 open load interrupt disabled
3	IO6SCIE	R/W	0	HVIO6 short circuit interrupt disabled
			1	HVIO6 short circuit interrupt enabled
2	IO6OLIE	R/W	0	HVIO6 open load interrupt enabled
			1	HVIO6 open load interrupt disabled

Table 71. Bank 1 fail interrupt enable register (address 48h) ...continued
 Not available in UJA113xFD/x.

Bit	Symbol	Access	Value	Description
1	IO5SCIE	R/W	0	HVIO5 short circuit interrupt disabled
			1	HVIO5 short circuit interrupt enabled
0	IO5OLIE	R/W	0	HVIO5 open load interrupt enabled
			1	HVIO5 open load interrupt disabled

7.13 Non-volatile SBC configuration

The UJA113x contains Multiple Time Programmable Non-Volatile (MTPNV) memory cells that allow some of the default device settings to be reconfigured. The MTPNV memory address range is from 0x71 to 0x74. An overview of the MTPNV registers is given in [Table 72](#). Details on bit settings, including factory preset values, can be found in [Table 9](#), [Table 11](#), [Table 45](#) and [Table 46](#).

Table 72. Overview of MTPNV registers

Addr.	Register Name	Bit:							
		7	6	5	4	3	2	1	0
0x71	HVIO high-side control ^[1]	IO8HOC	IO7HOC	IO6HOC	IO5HOC	IO4HOC	IO3HOC	IO2HOC	IO1HOC
0x72	HVIO low-side control ^[1]	IO8LOC	IO7LOC	IO6LOC	IO5LOC	IO4LOC	IO3LOC	IO2LOC	IO1LOC
0x73	Start-up control	reserved		RLC		V2SUC	IO4SFC	IO3SFC	IO2SFC
0x74	SBC configuration ctrl.	reserved		V1RTSUC		FNMC	SDMC	VEXTAC	SLPC

[1] For derivatives without the relevant HVIO pin, the associated bit is set to 0; this needs to be taken into account when calculating the CRC value.

7.13.1 Programming the MTPNV cells

Bit NVMP5 in the MTPNV status register ([Table 73](#)) must be set to 1 before the non-volatile memory cells can be reprogrammed. Bit NVMP5 is pre-set to 1 when the device is shipped. It is reset to 0 after the cells have been programmed. The battery supply voltage must be within the range specified for MTPNV programming ($V_{\text{prog(MTPNV)}}$; see [Table 90](#)) while the cells are being programmed.

NVMP5 can be set to 1 again by restoring the factory presets (see [Section 7.13.2](#)). When the factory presets are restored, a system reset is generated, automatically forcing the UJA113x to switch to Forced Normal mode (since FNMC = 1). This ensures that the programming cycle cannot be interrupted by the watchdog.

Programming of the non-volatile memory registers is performed in two steps. First, the required values are written to addresses 0x71 to 0x74. In the second step, reprogramming is confirmed by writing the correct CRC value to the MTPNV CRC control register (see [Section 7.13.1.1](#)). The SBC starts reprogramming the MTPNV cells as soon as the CRC value has been validated. If the CRC value is not correct, reprogramming is aborted. On completion, a system reset is generated to indicate that the MTPNV cells have been reprogrammed successfully. Note that updated contents of registers 0x71 to 0x74 cannot be read until the programming process has been successfully completed.

After an MTPNV programming cycle has been completed, the non-volatile memory is protected against being overwritten via a standard SPI write operation.

The MTPNV status register (Table 73) contains a write counter, WRCNTS, that is incremented each time the MTPNV cells are reprogrammed (up to a maximum value of 111111; there is no overflow). Note that this counter is provided for information purposes only; reprogramming will not be aborted if it reaches its maximum value. An error correction code status bit, ECCS, indicates whether reprogramming was successful. It is not recommended to program the MTPNV cells more than $N_{cy(W)MTP}$ times (see Table 90).

Table 73. MTPNV status register (address 70h)

Bit	Symbol	Access	Value	Description
7:2	WRCNTS	R	xxxxxx	write counter: contains the number of times the MTPNV cells were reprogrammed
1	ECCS	R	0	no error detected during MTPNV cell programming
			1	an error was detected during MTPNV cell programming
0	NVMPS	R	0	MTPNV memory cannot be overwritten
			1	MTPNV memory is ready to be reprogrammed

7.13.1.1 Calculating the CRC value for MTP programming

The cyclic redundancy check value stored in bits CRCC in the MTPNV CRC control register is calculated using the data written to registers 0x71 to 0x74. Not writing to one of these registers is equivalent to writing 00h to that register.

Table 74. MTPNV CRC control register (address 75h)

Bit	Symbol	Access	Value	Description
7:0	CRCC	R/W	-	CRC control data

The CRC value is calculated using the data representation shown in Figure 22 and the modulo-2 division with the generator polynomial: $X^8 + X^5 + X^3 + X^2 + X + 1$. The result of this operation must be bitwise inverted.



Fig 22. Data representation for CRC calculation

The following parameters can be used to calculate the CRC value (e.g. via the Autosar method):

Table 75. Parameters for CRC coding

Parameter	Value
CRC result width	8 bits
Polynomial	0x2F
Initial value	0xFF

Table 75. Parameters for CRC coding ...continued

Parameter	Value
Input data reflected	no
Result data reflected	no
XOR value	0xFF

Alternatively, the following algorithm can be used:

```

data = 0 // unsigned byte
crc = 0xFF
for i = 0 to 3
  data = content_of_address(0x71 + i) EXOR crc
  for j = 0 to 7
    if data ≥ 128
      data = data * 2 // shift left by 1
      data = data EXOR 0x2F
    else
      data = data * 2 // shift left by 1
  next j
  crc = data
next i
crc = crc EXOR 0xFF

```

7.13.2 Restoring factory preset values

Factory preset values are restored when the following conditions apply for at least $t_{d(MTPNV)}$ during power-up:

- pin RSTN is held LOW
- CANH is pulled up to V_{BAT}
- CANL is pulled down to GND

After the factory preset values have been restored, the SBC enters Forced normal Mode. Since the CAN-bus is clamped dominant, pin RXDC will be LOW. During the factory preset restore process, this pin is forced HIGH to allow a falling edge to signal that the process has been completed.

The write counter, WRCNTS, in the MTPNV status register is incremented every time the factory presets are restored.

7.14 Device ID

Two bytes are reserved at addresses 0x7E and 0x7F for the UJA113x identification codes. ID0S and ID1S combine to indicate the UJA113x series variant, as detailed in [Table 78](#).

Table 76. Identification register 1 (address 7Eh)

Bit	Symbol	Access	Value	Description
7:0	ID0S	R	see Table 78	device identification code (part 1)

Table 77. Identification register 2 (address 7Fh)

Bit	Symbol	Access	Value	Description
7:6	ID1S	R	see Table 78	device identification code (part 2)
5:0	IDVS	R		silicon version:
			xx0xxx	UJA113xHW
			xx1xxx	UJA113xFD

Table 78. Identification codes

Variant	ID0S (8 LBSs of ID code)	ID1S (2 MSBs of ID code)
UJA1131HW/5V0	0x11	0x0
UJA1131HW/3V3	0x10	0x0
UJA1132HW/5V0	0x01	0x0
UJA1132HW/3V3	0x00	0x0
UJA1135HW/5V0	0x11	0x1
UJA1135HW/3V3	0x10	0x1
UJA1136HW/5V0	0x01	0x1
UJA1136HW/3V3	0x00	0x1
UJA1131HW/FD/5V/4	0x51	0x0
UJA1131HW/FD/3V/4	0x50	0x0
UJA1131HW/FD/5V/0	0x71	0x0
UJA1131HW/FD/3V/0	0x70	0x0
UJA1132HW/FD/5V/4	0x41	0x0
UJA1132HW/FD/3V/4	0x40	0x0
UJA1132HW/FD/5V/0	0x61	0x0
UJA1132HW/FD/3V/0	0x60	0x0

7.15 General-purpose memory

The UJA113x allocates 4 bytes of RAM as general-purpose memory for storing user information. The general-purpose registers can be accessed via the SPI at addresses 0x06 to 0x09 (see [Table 80](#)).

7.16 SPI

7.16.1 Introduction

The Serial Peripheral Interface (SPI) provides the communication link with the microcontroller, supporting multi-slave operations. The SPI is configured for full-duplex data transfer, so status information is returned when new control data is shifted in. The interface also offers a read-only access option, allowing the application to read back the data without changing the register content.

The SPI uses four interface signals for synchronization and data transfer:

- SCSN: SPI chip select; active LOW
- SCK: SPI clock; default level is LOW due to low-power concept
- SDI: SPI data input
- SDO: SPI data output; floating when pin SCSN is HIGH

Bit sampling is performed on the falling clock edge and data is shifted on the rising clock edge (see [Figure 23](#)).



Fig 23. SPI timing protocol

The SPI data in the UJA113x is stored in a number of dedicated 8-bit registers. Each register is assigned a unique 7-bit address. Two bytes need to be transmitted to the SBC for a single register write operation. The first byte contains the 7-bit address along with a 'read-only' bit (the LSB). The read-only bit must be 0 to indicate a write operation (if this bit is 1, a read operation is assumed and any data on the SDI pin is ignored). The second byte contains the data to be written to the register.

24- and 32-bit write operations are also supported. The register address is automatically incremented, once for a 24-bit operation and twice for a 32-bit operation, as illustrated in [Figure 24](#).



Fig 24. SPI data structure for a write operation (16-, 24- or 32-bit)

During an SPI data write operation, the contents of the addressed register(s) is returned via pin SDO. This also happens for a read operation (where the read-only bit is set to 1).

During a write operation, the UJA113x monitors the number of SPI bits transmitted. If the number recorded is not 16, 24 or 32, the write operation is aborted and an SPI failure interrupt is generated (SPIFI = 1), if enabled (SPIFIE = 1).

The SBC is ready to process an SPI operation $t_{to(SPI)}$ after leaving Reset mode. Any attempt to read or write before this timeout time has elapsed will generate an SPI failure interrupt

A delay of at least $t_{d(W)SPI}$ must be inserted between consecutive SPI write operations to the same register, otherwise the SBC may not execute the first write access. The delay is measured between successive rising edges on SCSN.

The UJA113x tolerates attempts to write to registers that do not exist. If the available address space is exceeded during a write operation, the data overflows into address 0x00 (without generating an SPI failure interrupt).

An SPI failure interrupt is generated if an illegal SPI message is received (e.g. the number of bits transmitted is not 16, 24 or 32). The received information is ignored and register contents are not modified. If an SPI write operation does not trigger an interrupt, the data has been successfully written to the addressed register.

7.16.2 Register map

The addressable register space contains 128 registers with addresses from 0x00 to 0x7F. The registers are divided into eight functional groups, as shown in [Table 79](#). An overview of the register mapping is provided in [Table 80](#) to [Table 86](#). The functionality of individual bits is discussed in more detail in the relevant sections of the data sheet. Note that not all registers and bits are available in all UJA113x derivatives.

Table 79. Register groupings

Address range	Description	Content
0x00 to 0x0F	Primary control registers	SBC mode, watchdog, reset, limp-home, Overtemp, EN control
0x10 to 0x1F	Supply control registers	Battery monitoring, V1, V2, SMPS control
0x20 to 0x2F	Transceiver control registers	CAN, LIN1 and LIN2 control
0x30 to 0x3F	HVIO bank 0 control registers	Control of HVIO1 to HVIO4
0x40 to 0x4F	HVIO bank 1 control registers	Control of HVIO5 to HVIO8
0x50 to 0x5F	Timer control registers	Timer 1 to 4 control
0x60 to 0x6F	Interrupt status registers	Interrupt status information
0x70 to 0x7F	MTPNV and ID registers	MTPNV register access

Table 80. Overview of primary control registers

Address	Register Name	Bit:								
		7	6	5	4	3	2	1	0	
0x00	Watchdog control	WMC			reserved	NWP				
0x01	Mode control	reserved					MC			
0x02	Fail-safe control	ENSC		ENDC	ENC		LHC	RCC		
0x03	Main status	reserved	OTWS	NMS	RSS					
0x04	System interrupt enable	reserved					OTWIE	SPIFIE	reserved	
0x05	Watchdog status	reserved			FNMS	SDMS	WDS			
0x06	Memory 0	GPM[7:0]								
0x07	Memory 1	GPM[15:8]								
0x08	Memory 2	GPM[23:16]								
0x09	Memory 3	GPM[31:24]								
0x0A	Lock control	reserved	LK6C	LK5C	LK4C	LK3C	LK2C	LK1C	LK0C	
0x0B to 0x0F		reserved								

Table 81. Overview of supply control registers

Addr.	Register Name	Bit:								
		7	6	5	4	3	2	1	0	
0x10	Regulator control	reserved	V2SC		V2C		V1RTC			
0x11	Battery monitor interrupt ctrl.	reserved							BMSC	
0x12	Battery monitor UV control	BMUTC								
0x13	Battery monitor OV control	BMOTC								
0x14	Battery monitor hys. ctrl.	BMHOC				BMHUC				
0x15	V _{BAT} ADC results 1	BMBCD								
0x16	V _{BAT} ADC results 2	reserved					BMBCS	BMBCD		
0x17	BATSENSE ADC results 1	BMSCD								
0x18	BATSENSE ADC results 2	reserved					BMSCS	BMSCD		
0x19	SMPS control	reserved			SMPSOTC	reserved	SMPSC			
0x1A	SMPS o/p voltage control	reserved			SMPSOC					

Table 81. Overview of supply control registers ...continued

Addr.	Register Name	Bit:							
		7	6	5	4	3	2	1	0
0x1B	Supply voltage status	reserved		BMOVS	BMUVS	SMPSS	VEXTS		V1S
0x1C	Supply interrupt enable	reserved		SMPSSIE	BMOIE	BMUIE	VEXTOIE	VEXTUIE	V1UIE
0x1D to 0x1F		reserved							

Table 82. Overview of transceiver control registers

Address	Register Name	Bit:								
		7	6	5	4	3	2	1	0	
0x20	CAN control	reserved	CFDC	PNCOK	CPNC	CSC		CMC		
0x21	LIN control	LSC2		LMC2		LSC1		LMC1		
0x22	Transceiver status	CTS	CPNERR	CPNS	COSCS	CBSS	VLINS	VCS	CFS	
0x23	Transceiver interrupt enable	reserved			CBSIE	LWI2E	LWI1E	CFIE	CWIE	
0x24 to 0x25		reserved								
0x26	Data rate	reserved					CDR			
0x27	ID 0	ID[7:0]								
0x28	ID 1	ID[15:8]								
0x29	ID 2	ID[23:16]								
0x2A	ID 3	reserved			ID[28:24]					
0x2B	Mask 0	M[7:0]								
0x2C	Mask 1	M[15:8]								
0x2D	Mask 2	M[23:16]								
0x2E	Mask 3	reserved			M[28:24]					
0x2F	Frame control	IDE	PNDM	reserved		DLC				

Table 83. Overview of HVIO control registers

Addr.	Register Name	Bit:								
		7	6	5	4	3	2	1	0	
0x30	HVIO1 control	IO1SC		IO1AC			IO1CC			
0x31	HVIO2 control	IO2SC		IO2AC			IO2CC			
0x32	HVIO3 control	IO3SC		IO3AC			IO3CC			
0x33	HVIO4 control	IO4SC		IO4AC			IO4CC			
0x34	Bank 0 threshold control	reserved							B0WTC	
0x35	Bank 0 wake-up status	reserved			IO4WLS		IO3WLS	IO2WLS	IO1WLS	
0x36	Bank 0 driver status	IO4DS		IO3DS		IO2DS		IO1DS		
0x37	Bank 0 wake int. enable	IO4FEIE	IO4REIE	IO3FEIE	IO3REIE	IO2FEIE	IO2REIE	IO1FEIE	IO1REIE	
0x38	Bank 0 fail int. enable	IO4SCIE	IO4OLIE	IO3SCIE	IO3OLIE	IO2SCIE	IO2OLIE	IO1SCIE	IO1OLIE	
0x39	Bank 0 s/c threshold ctrl.	IO4SCTC		IO3SCTC		IO2SCTC		IO1SCTC		
0x3A	Bank 0 o/l threshold ctrl.	IO4OLTC		IO3OLTC		IO2OLTC		IO1OLTC		
0x3B to 0x3F		reserved								
0x40	HVIO5 control	IO5SC		IO5AC			IO5CC			
0x41	HVIO6 control	IO6SC		IO6AC			IO6CC			

Table 83. Overview of HVIO control registers ...continued

Addr.	Register Name	Bit:							
		7	6	5	4	3	2	1	0
0x42	HVIO7 control	IO7SC		IO7AC			IO7CC		
0x43	HVIO8 control	IO8SC		IO8AC			IO8CC		
0x44	Bank 1 threshold control	reserved							B1WTC
0x45	Bank 1 wake-up status	reserved				IO8WLS	IO7WLS	IO6WLS	IO5WLS
0x46	Bank 1 driver status	IO8DS		IO7DS		IO6DS		IO5DS	
0x47	Bank 1 wake int. enable	IO8FEIE	IO8REIE	IO7FEIE	IO7REIE	IO6FEIE	IO6REIE	IO5FEIE	IO5REIE
0x48	Bank 1 fail int. enable	IO8SCIE	IO8OLIE	IO7SCIE	IO7OLIE	IO6SCIE	IO6OLIE	IO5SCIE	IO5OLIE
0x49	Bank 0 s/c threshold ctrl.	IO8SCTC		IO7SCTC		IO6SCTC		IO5SCTC	
0x4A	Bank 0 o/l threshold ctrl.	IO8OLTC		IO7OLTC		IO6OLTC		IO5OLTC	
0x4B to 0x4F		reserved							

Table 84. Overview of timer control registers

Address	Register Name	Bit:							
		7	6	5	4	3	2	1	0
0x50	Timer 1 control	reserved		T1PC			res.		T1MC
0x51	Timer 1 duty cycle control	T1DCC							
0x52	Timer 2 control	reserved		T2PC			T2MC		
0x53	Timer 2 duty cycle control	T2DCC							
0x54	Timer 3 control	reserved		T3PC			T3MC		
0x55	Timer 3 duty cycle control	T3DCC							
0x56	Timer 4 control	reserved		T4PC			T4MC		
0x57	Timer4 duty cycle control	T4DCC							
0x58 to 0x5F		reserved							

Table 85. Overview of interrupt status registers

Addr.	Register Name	Bit:							
		7	6	5	4	3	2	1	0
0x60	Global interrupt status	reserved	B1FIS	B1WIS	B0FIS	B0WIS	TRXIS	SUPIS	SYSIS
0x61	System interrupt status	reserved		OVSDI	POSI	reserved	OTWI	SPIFI	WDI
0x62	Supply interrupt status	reserved		SMPSSI	BMOI	BMUI	VEXTOI	VEXTUI	V1UI
0x63	Transceiver interrupt status	reserved		PNFDEI	CBSI	LWI2	LWI1	CFI	CWI
0x64	Bank 0 wake-up interrupt status	IO4FEI	IO4REI	IO3FEI	IO3REI	IO2FEI	IO2REI	IO1FEI	IO1REI
0x65	Bank 0 fail interrupt status	IO4SCI	IO4OLI	IO3SCI	IO3OLI	IO2SCI	IO2OLI	IO1SCI	IO1OLI
0x66	Bank 1 wake-up interrupt status	IO8FEI	IO8REI	IO7FEI	IO7REI	IO6FEI	IO6REI	IO5FEI	IO5REI
0x67	Bank 1 fail interrupt status	IO8SCI	IO8OLI	IO7SCI	IO7OLI	IO6SCI	IO6OLI	IO5SCI	IO5OLI
0x68	Data mask 0	DM0[7:0]							
0x69	Data mask 1	DM1[7:0]							
0x6A	Data mask 2	DM2[7:0]							
0x6B	Data mask 3	DM3[7:0]							
0x6C	Data mask 4	DM4[7:0]							

Table 85. Overview of interrupt status registers ...continued

Addr.	Register Name	Bit:							
		7	6	5	4	3	2	1	0
0x6D	Data mask 5	DM5[7:0]							
0x6E	Data mask 6	DM6[7:0]							
0x6F	Data mask 7	DM7[7:0]							

Table 86. Overview of MTPNV and ID registers

Addr.	Register Name	Bit:							
		7	6	5	4	3	2	1	0
0x70	MTPNV interrupt status	WRCNTS						ECCS	NVMPS
0x71	HVIO high-side control	IO8HOC	IO7HOC	IO6HOC	IO5HOC	IO4HOC	IO3HOC	IO2HOC	IO1HOC
0x72	HVIO low-side control	IO8LOC	IO7LOC	IO6LOC	IO5LOC	IO4LOC	IO3LOC	IO2LOC	IO1LOC
0x73	Start-up control	reserved		RLC		V2SUC	IO4SFC	IO3SFC	IO2SFC
0x74	SBC configuration ctrl.	reserved		V1RTSUC		FNMC	SDMC	VEXTAC	SLPC
0x75	MTPNV CRC control	CRCC							
0x76 to 0x7D		reserved							
0x7E	Identification register 1	ID0S							
0x7F	Identification register 2	ID1S			IDVS				

7.16.3 Register configuration in SBC operating modes

A number of register bits may change state automatically when the UJA113x switches from one operating mode to another. This is particularly evident when the UJA113x switches to Off mode. These changes are summarized in [Table 87](#). If an SPI transmission is in progress when the UJA113x changes state, the transmission is ignored (automatic state changes have priority).

Table 87. Register bit settings in SBC operating modes

Symbol	Off (power-on default)	Standby	Normal	Sleep	Reset	Overload	FSP
B0FIS	0	no change	no change	no change	no change	no change	0
B0WIS	0	no change	no change	no change	no change	no change	0
B0WTC	0	no change	no change	no change	no change	no change	no change
B1FIS	0	no change	no change	no change	no change	no change	0
B1WIS	0	no change	no change	no change	no change	no change	0
B1WTC	0	no change	no change	no change	no change	no change	no change
BMBCD ^[1]	000000000	-	actual state	-	-	-	-
BMBCS	0	actual state	actual state	actual state	actual state	actual state	actual state
BMSCD ^[1]	000000000	-	actual state	-	-	-	-
BMSCS	0	actual state	actual state	actual state	actual state	actual state	actual state
BMHOC	0000	no change	no change	no change	no change	no change	no change
BMHUC	0000	no change	no change	no change	no change	no change	no change
BMOI	0	no change	no change	no change	no change	no change	0
BMOIE	0	no change	no change	no change	no change	no change	0
BMOTC	11111111	no change	no change	no change	no change	no change	no change

Table 87. Register bit settings in SBC operating modes ...continued

Symbol	Off (power-on default)	Standby	Normal	Sleep	Reset	Overload	FSP
BMOVS	0	actual state	actual state	actual state	actual state	actual state	actual state
BMSC	0	no change	no change	no change	no change	no change	no change
BMUI	0	no change	no change	no change	no change	no change	0
BMUIE	0	no change	no change	no change	no change	no change	0
BMUTC	00000000	no change	no change	no change	no change	no change	no change
BMUVS	0	actual state	actual state	actual state	actual state	actual state	actual state
CBSI	0	no change	no change	no change	no change	no change	0
CBSIE	0	no change	no change	no change	no change	no change	0
CBSS	0	1	actual state	1	1	1	1
CDR	101	no change	no change	no change	no change	no change	101
CFDC	0	no change	no change	no change	no change	no change	no change
CFI	0	no change	no change	no change	no change	no change	0
CFIE	0	no change	no change	no change	no change	no change	0
CFS	0	actual state	actual state	actual state	actual state	actual state	actual state
CMC	00	no change	no change	no change	no change	no change	00
COSCS	0	actual state	actual state	actual state	actual state	actual state	actual state
CPNC	0	no change	no change	no change	no change	no change	0
CPNERR	1	actual state	actual state	actual state	actual state	actual state	actual state
CPNS	0	actual state	actual state	actual state	actual state	actual state	actual state
CRCC	n.a.	n.a.	n.a.	n.a.	n.a.	n.a.	n.a.
CSC	01	no change	no change	no change	no change	no change	no change
CTS	0	0	actual state	0	0	0	0
CWI	0	no change	no change	no change	no change	no change	0
CWIE	0	no change	no change	no change	no change	no change	1
DLC	0000	no change	no change	no change	no change	no change	0000
DMn	11111111	no change	no change	no change	no change	no change	no change
ECCS	actual state	actual state	actual state	actual state	actual state	actual state	actual state
ENC	00	no change	no change	no change	no change	no change	no change
ENDC	0	no change	no change	no change	no change	no change	no change
ENSC	00	no change	no change	no change	no change	no change	no change
FNMC	MTPNV	MTPNV	MTPNV	MTPNV	MTPNV	MTPNV	MTPNV
FNMS	0	actual state	actual state	actual state	actual state	actual state	actual state
GPM	0000...0000	no change	no change	no change	no change	no change	no change
ID[28:0]	00...00	no change	no change	no change	no change	no change	00...00
IDM[28:0]	00...00	no change	no change	no change	no change	no change	00...00
IDnS	actual state	actual state	actual state	actual state	actual state	actual state	actual state
IONAC	000	no change	no change	no change	no change	no change	no change
IONCC	000 or defined by dedicated MTPNV bit IOnSFC	no change	no change	no change	no change	no change	no change

Table 87. Register bit settings in SBC operating modes ...continued

Symbol	Off (power-on default)	Standby	Normal	Sleep	Reset	Overload	FSP
IONDS	11	actual state	actual state	actual state	actual state	actual state	actual state
IONFEI	0	no change	no change	no change	no change	no change	0
IONFEIE	0	no change	no change	no change	no change	no change	1
IONHOC	MTPNV	MTPNV	MTPNV	MTPNV	MTPNV	MTPNV	MTPNV
IONLOC	MTPNV	MTPNV	MTPNV	MTPNV	MTPNV	MTPNV	MTPNV
IONOLI	0	no change	no change	no change	no change	no change	0
IONOLIE	0	no change	no change	no change	no change	no change	0
IONOLTC	00	no change	no change	no change	no change	no change	no change
IONREI	0	no change	no change	no change	no change	no change	0
IONREIE	0	no change	no change	no change	no change	no change	1
IONSC	00	no change	no change	no change	no change	00	00
IONSCI	0	no change	no change	no change	no change	no change	0
IONSCIE	0	no change	no change	no change	no change	no change	0
IONSCTC	00	no change	no change	no change	no change	no change	no change
IONSFC	MTPNV	MTPNV	MTPNV	MTPNV	MTPNV	MTPNV	MTPNV
IONWLS	0	actual state	actual state	actual state	actual state	actual state	actual state
LHC	0	no change	no change	no change	no change	1	1
LKnC	0	no change	no change	no change	no change	no change	no change
LMCn	00	no change	no change	no change	no change	no change	no change
LSCn	00	no change	no change	no change	no change	no change	no change
LWIn	0	no change	no change	no change	no change	no change	0
LWInE	0	no change	no change	no change	no change	no change	1
M[28:0]	00...00	no change	no change	no change	no change	no change	00...00
MC	100	100	111	001	100	don't care	001
NMS	1	no change	0	no change	no change	no change	no change
NVMPS	actual state	actual state	actual state	actual state	actual state	actual state	actual state
NWP	0100	no change	no change	no change	0100	0100	0100
OTWI	0	no change	no change	no change	no change	no change	0
OTWIE	0	no change	no change	no change	no change	no change	0
OTWS	0	actual state	actual state	actual state	actual state	actual state	actual state
OVSDI	0	no change	no change	no change	no change	no change	0
PNDM	1	no change	no change	no change	no change	no change	1
PNFDEI ^[2]	0	no change	no change	no change	no change	no change	0
PNCOK	0	no change	no change	no change	no change	no change	0
PNFDEI	0	no change	no change	no change	no change	no change	0
POSI	0	no change	no change	no change	no change	no change	0
RCC	00	no change	no change	no change	RCC++ if $V_{BAT} > V_{uvd(BATSMPS)}$, otherwise no change	no change	00

Table 87. Register bit settings in SBC operating modes ...continued

Symbol	Off (power-on default)	Standby	Normal	Sleep	Reset	Overload	FSP
RLC	MTPNV	MTPNV	MTPNV	MTPNV	MTPNV	MTPNV	MTPNV
RSS	00000	no change	no change	no change	reset source	10010	10101
SDMC	MTPNV	MTPNV	MTPNV	MTPNV	MTPNV	MTPNV	MTPNV
SDMS	0	actual state	actual state	actual state	actual state	actual state	actual state
SLPC	MTPNV	MTPNV	MTPNV	MTPNV	MTPNV	MTPNV	MTPNV
SMPSC	00	no change	no change	no change	00	00	00
SMPSOC	0101	no change	no change	0101	0101	0101	0101
SMPOTC	0	no change	no change	no change	0	0	0
SMPSS	0	actual state	actual state	actual state	actual state	actual state	actual state
SMPSSI	0	no change	no change	no change	no change	no change	0
SMPSSIE	0	no change	no change	no change	no change	no change	0
SPIFI	0	no change	no change	no change	no change	no change	0
SPIFIE	0	no change	no change	no change	no change	no change	0
SUPIS	0	no change	no change	no change	no change	no change	0
SYSIS	0	no change	no change	no change	no change	no change	0
T1DCC	00000000	no change	no change	no change	no change	no change	no change
T1MC	0	no change	no change	no change	no change	no change	no change
T1PC	0000	no change	no change	no change	no change	no change	no change
T2DCC	00000000	no change	no change	no change	no change	no change	no change
T2MC	00	no change	no change	no change	no change	no change	no change
T2PC	0000	no change	no change	no change	no change	no change	no change
T3DCC	00000000	no change	no change	no change	no change	no change	no change
T3MC	00	no change	no change	no change	no change	no change	no change
T3PC	0000	no change	no change	no change	no change	no change	no change
T4DCC	00000000	no change	no change	no change	no change	no change	no change
T4MC	00	no change	no change	no change	no change	no change	no change
T4PC	0000	no change	no change	no change	no change	no change	no change
TRXIS	0	no change	no change	no change	no change	no change	0
V1RTC	defined by V1RTSUC	no change	no change	no change	no change	no change	00
V1RTSUC	MTPNV	MTPNV	MTPNV	MTPNV	MTPNV	MTPNV	MTPNV
V1S	0	actual state	actual state	actual state	actual state	actual state	
V1UI	0	no change	no change	no change	no change	no change	0
V1UIE	0	no change	no change	no change	no change	no change	0
V2C	defined by V2SUC	no change	no change	no change	no change	no change	no change
VEXTOI	0	no change	no change	no change	no change	no change	0
VEXTOIE	0	no change	no change	no change	no change	no change	0
VEXTS	00	actual state	actual state	actual state	actual state	actual state	actual state
V2SC	00	no change	no change	no change	no change	no change	no change
VEXTAC	MTPNV	MTPNV	MTPNV	MTPNV	MTPNV	MTPNV	MTPNV

Table 87. Register bit settings in SBC operating modes ...continued

Symbol	Off (power-on default)	Standby	Normal	Sleep	Reset	Overload	FSP
VEXTUI	0	no change	no change	no change	no change	no change	0
VEXTUIE	0	no change	no change	no change	no change	no change	0
VCS	0	actual state	actual state	actual state	actual state	actual state	actual state
VLINS	0	actual state	actual state	actual state	actual state	actual state	actual state
WDI	0	no change	no change	no change	no change	no change	0
WDS	0	actual state	actual state	actual state	actual state	actual state	actual state
WMC	001 if SDMC = 1; otherwise 010	no change	no change	no change	001 if SDMC = 1; otherwise 010	no change	001 (Autonomous mode)
WRCNTS	actual state	actual state	actual state	actual state	actual state	actual state	actual state

[1] Note that battery monitoring is only enabled in Normal mode.

[2] UJA113xFD/x only; otherwise reserved.

8. Limiting values

Table 88. Limiting values

In accordance with the Absolute Maximum Rating System (IEC 60134).

Symbol	Parameter	Conditions	Min	Max	Unit
V _x	voltage on pin x ^[1]	pin V1 (max current I _{V1} = 50 mA) ^[2]	-0.3	+6	V
		pins V2 and VCAN	-0.3	+6	V
		pins TXDC, RXDC, EN, SDI, SDO, SCK, SCSN, TXDL1, TXDL2, RXDL1, RXDL2, RSTN, INTN1 and INTN2	-0.3	V _{V1} + 0.3	V
		pin VEXT	-18	+40	V
		pins HVIO1 to HVIO8 ^[3]	-18	+40	V
		pins BAT, BATHS1, BATHS2, BATSMPS, BATV2, L1, LIMP, BATSENSE, ADCCAP	-0.3	+40	V
		pin BOOTH1	V _{L1} - 0.3	V _{L1} + 3.6	V
		pin BOOTH2	V _{L2} - 0.3	V _{L2} + 3.6	V
		pins L2, VSMPS	-0.3	+18	V
		pin CAPA	-0.3	+3.6	V
		pin CAPB (internally shorted to GNDSMPS)	-0.3	+0.3	V
		pins CANH and CANL with respect to any other pin	-58	+58	V
		voltage difference between pin CANH and CANL	-40	+40	V
		pins LIN1 and LIN2 with respect to any other pin	-40	+40	V
GNDSMPS	-0.3	+0.3	V		
I _x	current on pin x	reverse polarity			
		pins BAT, BATHS1, BATHS2, BATSMPS, BATV2	-10	-	mA
I _{i(LIMP)}	input current on pin LIMP	LHC = 1	-	20	mA
I _{BATSENSE}	current on pin BATSENSE	continuous current; V _{BATSENSE} < 0 V	-18	-	mA
		peak current; V _{BATSENSE} < 0 V; t _{max} = 2 ms; ISO7637 pulse 1	-180	-	mA
I _r	reverse current	from pin V1 to pin VSMPS; V _{V1} ≤ 5 V ^[4]	-	500	mA
		from pin V2 to pin BATV2; V _{V2} ≤ 5 V ^[4]	-	100	mA
V _{trt}	transient voltage	on pins ^[5] BAT, BATHS1, BATHS2, BATSMPS, BATV2: via reverse polarity diode and capacitor to GND BATSENSE: coupling via 1 kΩ resistor and 10 nF capacitor to GND CANL, CANH: coupling via 1 nF capacitors LIN1, LIN2: coupling via 1 nF capacitors HVIO1 to HVIO8: coupling via 1 nF capacitors VEXT: coupling via 1 nF capacitor	-150	+100	V

Table 88. Limiting values ...continued
 In accordance with the Absolute Maximum Rating System (IEC 60134).

Symbol	Parameter	Conditions	Min	Max	Unit
V _{ESD}	electrostatic discharge voltage	IEC 61000-4-2 (150 pF, 330 Ω) [6]			
		pins BAT, BATHS1, BATHS2, BATSMPS, BATV2 with capacitor; CANH, CANL, LIN1 and LIN2, HVIO1 to HVIO8, BATSENSE with 10 nF capacitor and 1 kΩ resistor; VEXT with 2.2 μF capacitor [7]	-6	+6	kV
		Human Body Model (HBM); 100 pF, 1.5 kΩ [8]			
		all pins	-2	+2	kV
		pins CANH, CANL, LIN1, LIN2 [9]	-6	+6	kV
		pins BAT, BATV2, BATHS1, BATHS2, HVIO1 to HVIO8, BATSENSE, VEXT [7]	-4	+4	kV
		Charged Device Model (CDM); field Induced charge; 4 pF [10]			
		corner pins	-750	+750	V
		all other pins	-500	+500	V
T _{vj}	virtual junction temperature	[11]	-40	+150	°C
		when programming the MTPNV cells	0	+85	°C
T _{stg}	storage temperature		-55	+150	°C
T _{amb}	ambient temperature		-40	+125	°C

- [1] The device can sustain voltages up to the specified values over the product lifetime, provided applied voltages (including transients) never exceed these values.
- [2] V1 has an internal clamping mechanism that ensures that, in both supplied and unsupplied state, an injection current of 50 mA (max) flowing from the connected microcontroller can be tolerated without needing to specify the interface pins to a voltage higher than 6 V. This means that an external Zener diode is not needed to limit the output voltage on V1.
- [3] The difference between the supply voltage on pin BATHS1 and the voltage on any of pins HVIO1 to HVIO4 must not exceed 40 V; similarly the difference between the supply voltage on pin BATHS2 and the voltage on any of pins HVIO5 to HVIO8 must not exceed 40 V.
- [4] A reverse diode connected between V1 (anode) and VSMPS (cathode) limits the voltage drop voltage from V1(+) to VSMPS (-). A reverse diode connected between V2 (anode) and BATV2 (cathode) limits the voltage drop from V2(+) to BATV2 (-).
- [5] Verified by an external test house to ensure that pins can withstand ISO 7637 part 2 automotive transient test pulses 1, 2a, 3a and 3b.
- [6] According to IEC 61000-4-2; has been verified by an external test house.
- [7] Only tested relative to ground. Only valid for the application circuit shown in [Figure 31](#).
- [8] According to AEC-Q100-002.
- [9] V1, V2, BAT, BATHS1, BATHS2, BATSMPS, VSMPS, BATV2 and VCAN connected to GND, emulating application circuit.
- [10] According to AEC-Q100-011 Rev-C1. The classification level is C4B.
- [11] In accordance with IEC 60747-1. An alternative definition of virtual junction temperature is: $T_{vj} = T_{amb} + P \times R_{th(vj-a)}$, where $R_{th(vj-a)}$ is a fixed value to be used for the calculation of T_{vj} . The rating for T_{vj} limits the allowable combinations of power dissipation (P) and ambient temperature (T_{amb}).

9. Thermal characteristics

Table 89. Thermal characteristics

Symbol	Parameter	Conditions	Typ	Unit
$R_{th(vj-a)}$	thermal resistance from virtual junction to ambient		[1] 29	K/W
$R_{th(vj-c)}$	thermal resistance from virtual junction to case		[1] 10	K/W

[1] According to JEDEC JESD51-2, JESD51-5 and JESD51-7 at natural convection on 2s2p board. Board with two inner copper layers (thickness: 70 μm ; top and bottom layers: 35 μm) and thermal via array under the exposed pad connected to the first inner copper layer.

10. Static characteristics

Table 90. Static characteristics

$T_{vj} = -40\text{ °C}$ to $+150\text{ °C}$; $V_{BATSMPS} = V_{BAT} = 2\text{ V}$ to 28 V ; $V_{BATV2} = 5.5\text{ V}$ to 28 V ; $V_{BATHS1} = V_{BATHS2} = 4.5\text{ V}$ to 28 V ; $V_{VCAN} = 4.5\text{ V}$ to 5.5 V ; $R_{LIN1} = R_{LIN2} = 500\text{ }\Omega$; $R_{(CANH-CANL)} = 60\text{ }\Omega$; $L_{SMPS}^{[1]} = 22\text{ }\mu\text{H}$; $C_{SMPS}^{[1]} = 22\text{ }\mu\text{F}$; $V_{VSMPS} = 6\text{ V}$ (SMPSOC = 0101); C_{V1} and $C_{VEXT} > 1.76\text{ }\mu\text{F}$; all voltages are defined with respect to ground; positive currents flow into the IC; typical values are given at $V_{BATSMPS} = V_{BAT} = V_{BATV2} = V_{BATHS1} = V_{BATHS2} = 13\text{ V}$ and $T_{vj} = 25\text{ °C}$; unless otherwise specified.

Symbol	Parameter	Conditions	Min	Typ	Max	Unit
Supply current; pins BAT, BATV2, BATHS1, BATHS2, BATSMPS						
<i>Standby mode; CAN wake-up or no wake-up source enabled; $7.7\text{ V} < V_{BATSMPS} < 15\text{ V}$</i>						
I _{DD}	supply current	SMPS in Pass- through mode (SMPSC = 11); I _{V1} = 0 μA ; I _{VSMPS} = 0 μA				
		T _{vj} = -40 °C	-	75	-	μA
		T _{vj} = +25 °C	-	80	-	μA
		T _{vj} = +40 °C	-	83	-	μA
		T _{vj} = +85 °C	-	97	-	μA
		-40 °C < T _{vj} < +40 °C	-	-	110	μA
		-40 °C < T _{vj} < 85 °C	-	-	134	μA
<i>Sleep mode; CAN wake-up or no wake-up source enabled; $7.7\text{ V} < V_{BATSMPS} < 15\text{ V}$</i>						
I _{DD}	supply current	SMPS off (SMPSC = 00)				
		T _{vj} = -40 °C	-	43	-	μA
		T _{vj} = +25 °C	-	50	-	μA
		T _{vj} = +40 °C	-	52	-	μA
		T _{vj} = +85 °C	-	64	-	μA
		-40 °C < T _{vj} < +40 °C	-	-	70	μA
		-40 °C < T _{vj} < 85 °C	-	-	90	μA
		SMPS in Pass- through mode (SMPSC = 11); I _{VSMPS} = 0 μA				
-40 °C < T _{vj} < 85 °C	-	80	109	μA		
<i>Additional currents</i>						
I _{DD}	supply current	wake-up source currents				
		one LIN wake-up interrupt enabled: LWI1E = 1 or LWI2E = 1; -40 °C < T _{vj} < 85 °C	-	2	3	μA
		one HVIO bank input enabled: IOnCC = 011, 100 or 111 with n = 1 to 4 or n = 5 to 8; -40 °C < T _{vj} < 85 °C	-	2	3	μA
		V2 regulator on; VEXTAC = 1				
		T _{vj} = -40 °C	-	4	-	μA
		T _{vj} = +25 °C	-	4	-	μA
		T _{vj} = +40 °C	-	4	-	μA
		T _{vj} = +85 °C	-	4	-	μA
		-40 °C < T _{vj} < +85 °C	-	-	25	μA
		V2 regulator on; VEXTAC = 0; -40 °C < T _{vj} < 85 °C	-	80	107	μA

Table 90. Static characteristics ...continued

$T_{vj} = -40\text{ °C to }+150\text{ °C}$; $V_{BATSMPS} = V_{BAT} = 2\text{ V to }28\text{ V}$; $V_{BATV2} = 5.5\text{ V to }28\text{ V}$; $V_{BATHS1} = V_{BATHS2} = 4.5\text{ V to }28\text{ V}$; $V_{VCAN} = 4.5\text{ V to }5.5\text{ V}$; $R_{LIN1} = R_{LIN2} = 500\text{ }\Omega$; $R_{(CANH-CANL)} = 60\text{ }\Omega$; $L_{SMPS}^{[1]} = 22\text{ }\mu\text{H}$; $C_{SMPS}^{[1]} = 22\text{ }\mu\text{F}$; $V_{VSMPS} = 6\text{ V}$ (SMPSOC = 0101); C_{V1} and $C_{VEXT} > 1.76\text{ }\mu\text{F}$; all voltages are defined with respect to ground; positive currents flow into the IC; typical values are given at $V_{BATSMPS} = V_{BAT} = V_{BATV2} = V_{BATHS1} = V_{BATHS2} = 13\text{ V}$ and $T_{vj} = 25\text{ °C}$; unless otherwise specified.

Symbol	Parameter	Conditions	Min	Typ	Max	Unit
<i>Additional currents ... continued</i>						
I _{DD}	supply current	for first HVIO high-side driver activated (I _{OnAC} > 0) but not turned on; I _{HVIO_n} = 0 μ A	-	550	700	μ A
		for first HVIO high-side driver activated (I _{OnAC} > 0) and turned on; I _{HVIO_n} = 0 μ A	-	1000	1400	μ A
		for first active HVIO low-side driver (I _{OnAC} > 0); I _{HVIO_n} = 0 μ A	-	1000	1400	μ A
		SMPS active (SMPSOC = 00/01); I _{V1} = 0 μ A; I _{VSMPS} = 0 μ A; V _{BAT} = 13 V; V _{VSMPS} = 6 V	[2]	6	8	mA
		Normal mode; -40 °C < T _{vj} < 85 °C	-	1.2	1.7	mA
		CAN Offline Bias mode; -40 °C < T _{vj} < 85 °C	-	38	55	μ A
		CAN Active mode	-	160	280	μ A
		CAN Listen-only mode	-	60	125	μ A
		CAN partial networking	-	300	400	μ A
		LIN1/2 Active mode; LIN recessive; V _{TXDL1/2} = V _{V1} ; 5 V < V _{BAT} < 18 V	-	1.8	2.6	mA
		LIN1/2 Active mode; LIN dominant; V _{TXDL1/2} = 0 V; 5 V < V _{BAT} < 18 V	-	2.8	6.7	mA
		LIN Listen-only mode; 5 V < V _{BAT} < 18 V	-	-	100	μ A
Power on/off detection on pin BAT, VSMPS, BATHS1 and BATHS2						
V _{th(det)pon}	power-on detection threshold voltage	highest value on pin BAT or pin VSMPS	4.45	-	5.5	V
V _{hys(det)pon}	power-on detection hysteresis voltage	highest value on pin BAT or pin VSMPS	450	-	-	mV
V _{th(det)poff}	power-off detection threshold voltage	highest value on pin BAT or pin VSMPS	3.0	-	4.0	V
V _{uvd(CAN)}	CAN undervoltage detection voltage	highest value on pin BAT or pin VSMPS	4.45	-	5.5	V
V _{uvr(CAN)}	CAN undervoltage recovery voltage	highest value on pin BAT or pin VSMPS	4.7	-	6	V
V _{uvd}	undervoltage detection voltage	on pin BATHS1 or pin BATHS2	3.4	-	4.2	V
V _{uvd(LIN)}	LIN undervoltage detection voltage	on pin BAT	4.4	4.7	5.0	V

Table 90. Static characteristics ...continued

$T_{vj} = -40\text{ }^{\circ}\text{C}$ to $+150\text{ }^{\circ}\text{C}$; $V_{BATSMPS} = V_{BAT} = 2\text{ V}$ to 28 V ; $V_{BATV2} = 5.5\text{ V}$ to 28 V ; $V_{BATHS1} = V_{BATHS2} = 4.5\text{ V}$ to 28 V ; $V_{VCAN} = 4.5\text{ V}$ to 5.5 V ; $R_{LIN1} = R_{LIN2} = 500\text{ }\Omega$; $R_{(CANH-CANL)} = 60\text{ }\Omega$; $L_{SMPS}^{[1]} = 22\text{ }\mu\text{H}$; $C_{SMPS}^{[1]} = 22\text{ }\mu\text{F}$; $V_{VSMPS} = 6\text{ V}$ (SMPSOC = 0101); C_{V1} and $C_{VEXT} > 1.76\text{ }\mu\text{F}$; all voltages are defined with respect to ground; positive currents flow into the IC; typical values are given at $V_{BATSMPS} = V_{BAT} = V_{BATV2} = V_{BATHS1} = V_{BATHS2} = 13\text{ V}$ and $T_{vj} = 25\text{ }^{\circ}\text{C}$; unless otherwise specified.

Symbol	Parameter	Conditions	Min	Typ	Max	Unit
$V_{uvr(LIN)}$	LIN undervoltage recovery voltage	on pin BAT	4.9	5.2	5.5	V
$V_{hys(ugd)LIN}$	LIN undervoltage detection hysteresis voltage	on pin BAT	200	-	-	mV
Load dump activation/release: supply pins BAT, BATV2, BATHS1, BATHS2						
$V_{th(det)ov}$	overvoltage detection threshold voltage		30	-	34	V
$V_{th(rel)ov}$	overvoltage release threshold voltage		29	-	33	V
High-speed CAN: pin VCAN						
$V_{uvd(VCAN)}$	undervoltage detection voltage on pin VCAN		4.5	-	4.75	V
$I_{DD(CAN)}$	CAN supply current	CAN Active mode; CAN recessive; $V_{TXDC} = V_{V1}$	1	3	6	mA
		CAN Active mode; CAN dominant; $V_{TXDC} = 0\text{ V}$; $R_{(CANH-CANL)} = \text{no load}$	3	7.5	15	mA
		CAN not in Active mode; $-40\text{ }^{\circ}\text{C} < T_{vj} < 85\text{ }^{\circ}\text{C}$	-	3	5	μA
SMPS Pass-through suppression: pins BATSMPS and VSMPS						
$V_{ovd(BATSMPS)}$	overvoltage detection voltage on pin BATSMPS	$V_{BATSMPS}$ rising	15	-	16	V
$V_{uvd(BATSMPS)}$	undervoltage detection voltage on pin BATSMPS	$V_{BATSMPS}$ falling	7.1	-	7.7	V
$I_{th(ocd)}$	overcurrent detection threshold current	on pin VSMPS; for switching from Pass-through mode to an active mode	150	-	350	mA
		$T_{vj} = 150\text{ }^{\circ}\text{C}$	150	-	300	mA
SMPS: pins L1 and L2						
$R_{(L1-BATSMPS)}$	resistance between pin L1 and pin BATSMPS	Pass-through mode	-	-	0.8	Ω
$R_{(L2-VSMPS)}$	resistance between pin L2 and pin VSMPS	Pass-through mode	-	-	0.8	Ω
SMPS: pin VSMPS						
V_O	output voltage	$I_{VSMPS} = -500\text{ mA}$ to 0 mA ^[2] ^[4]	V_{VSMPS} (nom) $\times 0.95$	V_{VSMPS} (nom)	V_{VSMPS} (nom) $\times 1.05$	V
		SMPS active within regulation window ^[4]	V_{VSMPS} (act) $- 60\text{ mV}$	-	V_{VSMPS} (act) $+ 60\text{ mV}$	V

Table 90. Static characteristics ...continued

$T_{vj} = -40\text{ °C to }+150\text{ °C}$; $V_{BATSMPS} = V_{BAT} = 2\text{ V to }28\text{ V}$; $V_{BATV2} = 5.5\text{ V to }28\text{ V}$; $V_{BATHS1} = V_{BATHS2} = 4.5\text{ V to }28\text{ V}$; $V_{VCAN} = 4.5\text{ V to }5.5\text{ V}$; $R_{LIN1} = R_{LIN2} = 500\text{ }\Omega$; $R_{(CANH-CANL)} = 60\text{ }\Omega$; $L_{SMPS}^{[1]} = 22\text{ }\mu\text{H}$; $C_{SMPS}^{[1]} = 22\text{ }\mu\text{F}$; $V_{VSMPS} = 6\text{ V}$ (SMPSOC = 0101); C_{V1} and $C_{VEXT} > 1.76\text{ }\mu\text{F}$; all voltages are defined with respect to ground; positive currents flow into the IC; typical values are given at $V_{BATSMPS} = V_{BAT} = V_{BATV2} = V_{BATHS1} = V_{BATHS2} = 13\text{ V}$ and $T_{vj} = 25\text{ °C}$; unless otherwise specified.

Symbol	Parameter	Conditions	Min	Typ	Max	Unit	
$I_{sc(SMPS)}$	SMPS short circuit current	$V_{BATSMPS} = 4\text{ V}$	-	1.2	-	A	
		$V_{BATSMPS} = 8\text{ V}$	-	1.4	-	A	
		$V_{BATSMPS} = 12\text{ V}$	-	1.6	-	A	
		$V_{BATSMPS} = 16\text{ V}$	-	1.85	-	A	
SMPS performance: pin BATSMPS							
V_{DD}	supply voltage	UJA1131 and UJA1132 $V_{VSMPS} = 6\text{ V}$ (SMPSOC = 0101)					
		$I_{VSMPS} = -50\text{ mA}$	2	-	28	V	
		$I_{VSMPS} = -150\text{ mA}$	2.5	-	28	V	
		$I_{VSMPS} = -240\text{ mA}$	3.25	-	28	V	
		$I_{VSMPS} = -400\text{ mA}$	4.5	-	28	V	
		$I_{VSMPS} = -500\text{ mA}$	5.5	-	28	V	
		$I_{VSMPS} = -700\text{ mA}$	7.0	-	28	V	
		UJA1131 and UJA1132; $V_{VSMPS} = 7\text{ V}$ (SMPSOC = 1010)					
		$I_{VSMPS} = -50\text{ mA}$	2	-	28	V	
		$I_{VSMPS} = -110\text{ mA}$	2.5	-	28	V	
		$I_{VSMPS} = -180\text{ mA}$	3.25	-	28	V	
		$I_{VSMPS} = -300\text{ mA}$	4.5	-	28	V	
		$I_{VSMPS} = -420\text{ mA}$	5.5	-	28	V	
		$I_{VSMPS} = -640\text{ mA}$	7.0	-	28	V	
		UJA1135 and UJA1136					
		$I_{VSMPS} = -10\text{ mA}$	2	-	28	V	
$I_{VSMPS} = -500\text{ mA}$	5.5	-	28	V			
Voltage source; pin V1							
V_O	output voltage	$V_{O(V1)nom} = 5\text{ V}$; $V_{SMPS} = 5.7\text{ V to }16\text{ V}$; $I_{V1} = -400\text{ mA to }0\text{ mA}$	4.9	5	5.1	V	
		$V_{O(V1)nom} = 5\text{ V}$; $V_{SMPS} = 5.9\text{ V to }16\text{ V}$; $I_{V1} = -500\text{ mA to }0\text{ mA}$	4.9	5	5.1	V	
		$I_{V1} = 50\text{ }\mu\text{A to }50\text{ mA}$	5.5	-	6	V	
		$V_{O(V1)nom} = 3.3\text{ V}$; $V_{SMPS} = 4.3\text{ V to }16\text{ V}$; $I_{V1} = -500\text{ mA to }0\text{ mA}$	3.234	3.3	3.366	V	
$R_{(VSMPS-V1)}$	resistance between pin VSMPS and pin V1	saturation down to power off; $I_{V1} = -500\text{ mA}$	-	-	2	Ω	
V_{uvd}	undervoltage detection voltage	90 %; $V_{O(V1)nom} = 5\text{ V}$	4.5	-	4.75	V	
		80 %; $V_{O(V1)nom} = 5\text{ V}$	4	-	4.25	V	
		70 %; $V_{O(V1)nom} = 5\text{ V}$	3.5	-	3.75	V	
		60 %; $V_{O(V1)nom} = 5\text{ V}$	3	-	3.25	V	
		90 %; $V_{O(V1)nom} = 3.3\text{ V}$	2.97	-	3.135	V	

Table 90. Static characteristics ...continued

$T_{vj} = -40\text{ °C to }+150\text{ °C}$; $V_{BATSMPS} = V_{BAT} = 2\text{ V to }28\text{ V}$; $V_{BATV2} = 5.5\text{ V to }28\text{ V}$; $V_{BATHS1} = V_{BATHS2} = 4.5\text{ V to }28\text{ V}$; $V_{VCAN} = 4.5\text{ V to }5.5\text{ V}$; $R_{LIN1} = R_{LIN2} = 500\text{ }\Omega$; $R_{(CANH-CANL)} = 60\text{ }\Omega$; $L_{SMPS}^{[1]} = 22\text{ }\mu\text{H}$; $C_{SMPS}^{[1]} = 22\text{ }\mu\text{F}$; $V_{VSMPS} = 6\text{ V}$ (SMPSOC = 0101); C_{V1} and $C_{VEXT} > 1.76\text{ }\mu\text{F}$; all voltages are defined with respect to ground; positive currents flow into the IC; typical values are given at $V_{BATSMPS} = V_{BAT} = V_{BATV2} = V_{BATHS1} = V_{BATHS2} = 13\text{ V}$ and $T_{vj} = 25\text{ °C}$; unless otherwise specified.

Symbol	Parameter	Conditions	Min	Typ	Max	Unit
V _{uvr}	undervoltage recovery voltage	90 %; V _{O(V1)nom} = 5 V	4.5	-	4.75	V
		90 %; V _{O(V1)nom} = 3.3 V	2.97	-	3.135	V
I _{O(sc)}	short-circuit output current		-900	-	-500	mA
Voltage source; pin V2/VEXT						
V _{uvd}	undervoltage detection voltage		4.5	-	4.75	V
V _{ovd}	overvoltage detection voltage		5.2	-	5.5	V
I _{O(sc)}	short-circuit output current		-280	-	-100	mA
V _O	output voltage	pin V2 shorted to pin VEXT; V _{BATV2} = 5.7 V to 28 V; I _{V2} = -100 mA to 0 mA; C _{VEXT} > 3.3 μF	4.9	5	5.1	V
		pin V2 not connected; V _{BATV2} = 5.7 V to 28 V; I _{V2} = -5 mA to 0 mA	4.925	5	5.05	V
		pin V2 not connected; V _{BATV2} = 5.7 V to 28 V; I _{V2} = -70 mA to -5 mA	4.9	5	5.1	V
R _(BATV2-V2)	resistance between pin BATV2 and pin V2	pin V2 shorted to pin VEXT on PCB; saturation; I _{V2} = -100 mA	-	-	7.5	Ω
R _(BATV2-VEXT)	resistance between pin BATV2 and pin VEXT	pin V2 not connected on PCB; saturation; I _{VEXT} = -70 mA	-	-	11	Ω
Serial peripheral interface inputs; pins SDI, SCK and SCSN						
V _{th(sw)}	switching threshold voltage	V _{V1} = 2.97 V to 5.5 V	0.25V _{V1}	-	0.75V _{V1}	V
V _{th(sw)hys}	switching threshold voltage hysteresis		0.05V _{V1}	-	-	V
R _{pd}	pull-down resistance	on pin SCK	40	60	80	kΩ
		on pin SDI; V _{SDI} < 0.25 × V _{V1}	40	60	80	kΩ
R _{pu}	pull-up resistance	on pin SCSN	40	60	80	kΩ
		on pin SDI; V _{SDI} > 0.75 × V _{V1}	40	60	80	kΩ
I _{LI(SDI)}	input leakage current on pin SDI		-5	-	+5	μA
C _i	input capacitance	V _i = V _{V1} [2]	-	3	6	pF
Serial peripheral interface data output; pin SDO						
V _{OH}	HIGH-level output voltage	I _{OH} = -4 mA; V _{V1} = 2.97 V to 5.5 V	V _{V1} - 0.4	-	-	V
V _{OL}	LOW-level output voltage	I _{OL} = 4 mA; V _{V1} = 2.97 V to 5.5 V	-	-	0.4	V
I _{LO(off)}	off-state output leakage current	V _{SCSN} = V _{V1} ; V _O = 0 V to V _{V1}	-5	-	+5	μA

Table 90. Static characteristics ...continued

$T_{vj} = -40\text{ °C to }+150\text{ °C}$; $V_{BATSMPS} = V_{BAT} = 2\text{ V to }28\text{ V}$; $V_{BATV2} = 5.5\text{ V to }28\text{ V}$; $V_{BATHS1} = V_{BATHS2} = 4.5\text{ V to }28\text{ V}$; $V_{VCAN} = 4.5\text{ V to }5.5\text{ V}$; $R_{LIN1} = R_{LIN2} = 500\text{ }\Omega$; $R_{(CANH-CANL)} = 60\text{ }\Omega$; $L_{SMPS}^{[1]} = 22\text{ }\mu\text{H}$; $C_{SMPS}^{[1]} = 22\text{ }\mu\text{F}$; $V_{VSMPS} = 6\text{ V}$ (SMPSOC = 0101); C_{V1} and $C_{VEXT} > 1.76\text{ }\mu\text{F}$; all voltages are defined with respect to ground; positive currents flow into the IC; typical values are given at $V_{BATSMPS} = V_{BAT} = V_{BATV2} = V_{BATHS1} = V_{BATHS2} = 13\text{ V}$ and $T_{vj} = 25\text{ °C}$; unless otherwise specified.

Symbol	Parameter	Conditions	Min	Typ	Max	Unit
C_o	output capacitance	SCSN = V_{V1} [2]	-	3	6	pF
Reset output; pin RSTN						
V_{OL}	LOW-level output voltage	$V_{V1} = 1\text{ V to }5.5\text{ V}$; pull-up resistor to $V_{V1} \geq 900\text{ }\Omega$; $-40\text{ °C} < T_{vj} < T_{th(act)otp(max)}$	0	-	$0.2V_{V1}$	V
R_{pu}	pull-up resistance		40	60	80	k Ω
$V_{th(sw)}$	switching threshold voltage	$V_{V1} = 2.97\text{ V to }5.5\text{ V}$	$0.25V_{V1}$	-	$0.75V_{V1}$	V
$V_{th(sw)hys}$	switching threshold voltage hysteresis		$0.05V_{V1}$	-	-	V
Interrupt output; pin INTN1 and INTN2						
V_{OL}	LOW-level output voltage	$I_{OL} = 4\text{ mA}$; $V_{V1} = 2.97\text{ V to }5.5\text{ V}$	-	-	0.4	V
Enable output; pin EN						
V_{OH}	HIGH-level output voltage	$I_{OH} = -4\text{ mA}$; $V_{V1} = 2.97\text{ V to }5.5\text{ V}$	$V_{V1} - 0.4$	-	-	V
V_{OL}	LOW-level output voltage	$I_{OL} = 4\text{ mA}$; $V_{V1} = 1.0\text{ V to }5.5\text{ V}$	-	-	$0.2V_{V1}$	V
Limp home output; pin LIMP						
V_o	output voltage	$I_{LIMP} = 0.8\text{ mA}$; LHC = 1; $-40\text{ °C} < T_{vj} < T_{th(act)otp(max)}$	-	-	0.4	V
I_L	leakage current	$V_{LIMP} = V_{BAT}$; LHC = 0	-	-	5	μA
CAN transmit data input; pin TXDC						
$V_{th(sw)}$	switching threshold voltage	$V_{V1} = 2.97\text{ V to }5.5\text{ V}$	$0.25V_{V1}$	-	$0.75V_{V1}$	V
$V_{th(sw)hys}$	switching threshold voltage hysteresis		$0.05V_{V1}$	-	-	V
R_{pu}	pull-up resistance		40	60	80	k Ω
CAN receive data output; pin RXDC						
V_{OH}	HIGH-level output voltage	$I_{OH} = -4\text{ mA}$; $V_{V1} = 2.97\text{ V to }5.5\text{ V}$	$V_{V1} - 0.4$	-	-	V
V_{OL}	LOW-level output voltage	$I_{OL} = 4\text{ mA}$; $V_{V1} = 2.97\text{ V to }5.5\text{ V}$	-	-	0.4	V
R_{pu}	pull-up resistance	CAN Offline mode	40	60	80	k Ω
High-speed CAN-bus lines; pins CANH and CANL						
$V_{O(dom)}$	dominant output voltage	CAN Active mode; $V_{TXDC} = 0\text{ V}$				
		pin CANH	2.75	3.5	4.5	V
		pin CANL	0.5	1.5	2.25	V
$V_{dom(TX)sym}$	transmitter dominant voltage symmetry	$V_{dom(TX)sym} = V_{VCAN} - V_{CANH} - V_{CANL}$; $V_{VCAN} = 5\text{ V}$	-400	-	+400	mV
V_{TXsym}	transmitter voltage symmetry	$V_{TXsym} = V_{CANH} + V_{CANL}$; $f_{TXD} = 250\text{ kHz}$; $C_{SPLIT} = 4.7\text{ nF}$ [2] [3]	$0.9V_{VCAN}$	-	$1.1V_{VCAN}$	V

Table 90. Static characteristics ...continued

$T_{vj} = -40\text{ °C to }+150\text{ °C}$; $V_{BATSMPS} = V_{BAT} = 2\text{ V to }28\text{ V}$; $V_{BATV2} = 5.5\text{ V to }28\text{ V}$; $V_{BATHS1} = V_{BATHS2} = 4.5\text{ V to }28\text{ V}$; $V_{VCAN} = 4.5\text{ V to }5.5\text{ V}$; $R_{LIN1} = R_{LIN2} = 500\text{ }\Omega$; $R_{(CANH-CANL)} = 60\text{ }\Omega$; $L_{SMPS}^{[1]} = 22\text{ }\mu\text{H}$; $C_{SMPS}^{[1]} = 22\text{ }\mu\text{F}$; $V_{VSMPS} = 6\text{ V}$ (SMPSOC = 0101); C_{V1} and $C_{VEXT} > 1.76\text{ }\mu\text{F}$; all voltages are defined with respect to ground; positive currents flow into the IC; typical values are given at $V_{BATSMPS} = V_{BAT} = V_{BATV2} = V_{BATHS1} = V_{BATHS2} = 13\text{ V}$ and $T_{vj} = 25\text{ °C}$; unless otherwise specified.

Symbol	Parameter	Conditions	Min	Typ	Max	Unit
$V_{O(dif)bus}$	bus differential output voltage	CAN Active mode (dominant); $V_{VCAN} = 4.75\text{ V to }5.5\text{ V}$; $V_{TXDC} = 0\text{ V}$; $R_{(CANH-CANL)} = 50\text{ }\Omega\text{ to }65\text{ }\Omega$	1.5	-	3.0	V
		CAN Active mode (dominant); $V_{VCAN} = 4.75\text{ V to }5.5\text{ V}$; $V_{TXDC} = 0\text{ V}$; $R_{(CANH-CANL)} = 45\text{ }\Omega\text{ to }65\text{ }\Omega$	1.4	-	3.0	V
		CAN Active/Listen-only modes; (recessive); $V_{TXDC} = V_{V1}$; $R_{(CANH-CANL)} = \text{no-load}$	-50	-	+50	mV
$V_{O(rec)}$	recessive output voltage	CAN Active mode; $V_{TXDC} = V_{V1}$; $R_{(CANH-CANL)} = \text{no-load}$	2.0	$0.5V_{VCAN}$	3.0	V
		CAN Offline mode; $R_{(CANH-CANL)} = \text{no-load}$	-0.1	-	+0.1	V
		CAN Offline Bias/Listen-only modes; $V_{VCAN} = 0\text{ V}$ $R_{(CANH-CANL)} = \text{no-load}$	2.0	2.5	3.0	V
$I_{O(dom)}$	dominant output current	CAN Active mode $V_{TXDC} = 0\text{ V}$; $V_{VCAN} = 5\text{ V}$				
		pin CANH; $V_{CANH} = -3\text{ V}$	-54	-	-	mA
		pin CANL; $V_{CANL} = 16\text{ V}$	-	-	54	mA
$I_{O(rec)}$	recessive output current	$V_{CANL} = V_{CANH} = -27\text{ V to }+32\text{ V}$; $V_{TXDC} = V_{V1}$	-3	-	+3	mA
$V_{th(RX)dif}$	differential receiver threshold voltage	CAN Active/Listen-only modes; $-12\text{ V} < V_{CANH} < +12\text{ V}$; $-12\text{ V} < V_{CANL} < +12\text{ V}$	0.5	0.7	0.9	V
		CAN Offline mode; $-12\text{ V} < V_{CANH} < +12\text{ V}$; $-12\text{ V} < V_{CANL} < +12\text{ V}$	0.4	0.7	1.15	V
$V_{hys(RX)dif}$	differential receiver hysteresis voltage	CAN Active mode; $-12\text{ V} < V_{CANH} < +12\text{ V}$; $-12\text{ V} < V_{CANL} < +12\text{ V}$	50	200	400	mV
$R_{i(cm)}$	common-mode input resistance		9	15	28	k Ω
ΔR_i	input resistance deviation		-1	-	+1	%
$R_{i(dif)}$	differential input resistance	$-12\text{ V} < V_{CANH} < +12\text{ V}$; $-12\text{ V} < V_{CANL} < +12\text{ V}$; valid for all CAN operating modes	19	30	52	k Ω
$C_{i(cm)}$	common-mode input capacitance		[2]	8	20	pF
$C_{i(dif)}$	differential input capacitance		[2]	4	10	pF

Table 90. Static characteristics ...continued

$T_{vj} = -40\text{ °C to }+150\text{ °C}$; $V_{BATSMPS} = V_{BAT} = 2\text{ V to }28\text{ V}$; $V_{BATV2} = 5.5\text{ V to }28\text{ V}$; $V_{BATHS1} = V_{BATHS2} = 4.5\text{ V to }28\text{ V}$; $V_{VCAN} = 4.5\text{ V to }5.5\text{ V}$; $R_{LIN1} = R_{LIN2} = 500\text{ }\Omega$; $R_{(CANH-CANL)} = 60\text{ }\Omega$; $L_{SMPS}^{[1]} = 22\text{ }\mu\text{H}$; $C_{SMPS}^{[1]} = 22\text{ }\mu\text{F}$; $V_{VSMPS} = 6\text{ V}$ (SMPSOC = 0101); C_{V1} and $C_{VEXT} > 1.76\text{ }\mu\text{F}$; all voltages are defined with respect to ground; positive currents flow into the IC; typical values are given at $V_{BATSMPS} = V_{BAT} = V_{BATV2} = V_{BATHS1} = V_{BATHS2} = 13\text{ V}$ and $T_{vj} = 25\text{ °C}$; unless otherwise specified.

Symbol	Parameter	Conditions	Min	Typ	Max	Unit
I_{LI}	input leakage current	$V_{BAT} = 0\text{ V}$; $V_{VCAN} = 0\text{ V}$ or shorted to GND via $47\text{ k}\Omega$; $V_{CANH} = V_{CANL} = 5\text{ V}$	-5	-	+5	μA
LIN transmit data inputs; pins TXDL1 and TXDL2						
$V_{th(sw)}$	switching threshold voltage	$V_{V1} = 2.97\text{ V to }5.5\text{ V}$	$0.25V_{V1}$	-	$0.75V_{V1}$	V
$V_{th(sw)hys}$	switching threshold voltage hysteresis		$0.05V_{V1}$	-	-	V
R_{pu}	pull-up resistance		40	60	80	$\text{k}\Omega$
LIN receive data output; pin RXDL1, RXDL2						
V_{OH}	HIGH-level output voltage	$I_{OH} = -4\text{ mA}$; $V_{V1} = 2.97\text{ V to }5.5\text{ V}$	$V_{V1} - 0.4$	-	-	V
V_{OL}	LOW-level output voltage	$I_{OL} = 4\text{ mA}$; $V_{V1} = 2.97\text{ V to }5.5\text{ V}$	-	-	0.4	V
R_{pu}	pull-up resistance	LIN Offline mode	40	60	80	$\text{k}\Omega$
LIN bus line; pin LIN1, LIN2						
I_{BUS_LIM}	current limitation for driver dominant state	LIN Active mode $V_{BAT} = V_{LIN1} = V_{LIN2} = 18\text{ V}$ $V_{TXDL1} = V_{TXDL2} = 0\text{ V}$	40	-	200	mA
$I_{BUS_PAS_rec}$	receiver recessive input leakage current	$5\text{ V} < V_{LINn} < 18\text{ V}$; $5\text{ V} < V_{BAT} < 18\text{ V}$; $V_{LINn} \geq V_{BAT}$; $V_{TXDLn} = V_{V1}$	-	-	20	μA
$I_{BUS_PAS_dom}$	receiver dominant input leakage current including pull-up resistor	$V_{TXDLn} = V_{V1}$; $V_{LINn} = 0\text{ V}$; $V_{BAT} = 12\text{ V}$	-1	-	-	mA
$I_{BUS_NO_GND}$	loss-of-ground bus current	$V_{BAT} = 12\text{ V}$; $V_{GND} = V_{BAT}$; $0\text{ V} < V_{LINn} < 18\text{ V}$	-1	-	+1	mA
$I_{BUS_NO_BAT}$	loss-of-battery bus current	$V_{BAT} = 0\text{ V}$; $0\text{ V} < V_{LINn} < 18\text{ V}$	-	-	30	μA
V_{BUSrec}	receiver recessive state	$V_{BAT} = 5\text{ V to }18\text{ V}$	$0.6V_{BAT}$	-	-	V
V_{BUSdom}	receiver dominant state	$V_{BAT} = 5\text{ V to }18\text{ V}$	-	-	$0.4V_{BAT}$	V
V_{BUS_CNT}	receiver center voltage	$V_{BUS_CNT} = (V_{BUSrec} + V_{BUSdom})/2$ $V_{BAT} = 5\text{ V to }18\text{ V}$; LIN Active mode	$0.475 \times V_{BAT}$	$0.5 \times V_{BAT}$	$0.525 \times V_{BAT}$	V
V_{HYS}	receiver hysteresis voltage	$V_{HYS} = V_{BUSrec} - V_{BUSdom}$; $V_{BAT} = 5\text{ V to }18\text{ V}$; LIN Active mode	-	-	$0.175 \times V_{BAT}$	V
$V_{SerDiode}$	voltage drop at the serial diode	in pull-up path with R_{slave} ; $I_{SerDiode} = 0.9\text{ mA}$	0.4	-	1	V
$C_{ext(LIN1)}$	external capacitance on pin LIN1	with respect to GND	-	-	30	pF
$C_{ext(LIN2)}$	external capacitance on pin LIN2	with respect to GND	-	-	30	pF
R_{slave}	slave resistance		20	30	60	$\text{k}\Omega$

Table 90. Static characteristics ...continued

$T_{vj} = -40\text{ °C to }+150\text{ °C}$; $V_{BATSMPS} = V_{BAT} = 2\text{ V to }28\text{ V}$; $V_{BATV2} = 5.5\text{ V to }28\text{ V}$; $V_{BATHS1} = V_{BATHS2} = 4.5\text{ V to }28\text{ V}$; $V_{VCAN} = 4.5\text{ V to }5.5\text{ V}$; $R_{LIN1} = R_{LIN2} = 500\text{ }\Omega$; $R_{(CANH-CANL)} = 60\text{ }\Omega$; $L_{SMPS}^{[1]} = 22\text{ }\mu\text{H}$; $C_{SMPS}^{[1]} = 22\text{ }\mu\text{F}$; $V_{VSMPS} = 6\text{ V}$ (SMPSOC = 0101); C_{V1} and $C_{VEXT} > 1.76\text{ }\mu\text{F}$; all voltages are defined with respect to ground; positive currents flow into the IC; typical values are given at $V_{BATSMPS} = V_{BAT} = V_{BATV2} = V_{BATHS1} = V_{BATHS2} = 13\text{ V}$ and $T_{vj} = 25\text{ °C}$; unless otherwise specified.

Symbol	Parameter	Conditions	Min	Typ	Max	Unit	
High-voltage I/O: pins HVIO1 to HVIO8							
$V_{th(sw)f}$	falling switching threshold voltage	absolute wake-up threshold: B0WTC = B1WTC = 1	2.4	-	3.75	V	
$V_{th(sw)r}$	rising switching threshold voltage	absolute wake-up threshold: B0WTC = B1WTC = 1	2.8	-	4.1	V	
$V_{th(sw)}$	switching threshold voltage	ratiometric wake-up threshold: B0WTC = B1WTC = 0	$0.38 \times V_{BATHSx}$	-	$0.6 \times V_{BATHSx}$	V	
$V_{hys(i)}$	input hysteresis voltage	absolute wake-up threshold: B0WTC = B1WTC = 1	250	-	800	mV	
		ratiometric wake-up threshold: B0WTC = B1WTC = 0	$0.025 \times V_{BATHSx}$	-	$0.2 \times V_{BATHSx}$	V	
I_i	input current	at wake-up	-	-	5	μA	
R_{on}	on-state resistance	between pins BATHSx and HVIO _n pins; HVIO _n configured as high-side driver; $I_{HVIO_n} = -60\text{ mA}$	[5]	-	-	24	Ω
		between pins BATHSx and HVIO _n pins; HVIO _n configured as high-side driver; $I_{HVIO_n} = -60\text{ mA}$; $T_{vj} = 175\text{ °C}$	[5]	-	-	27	Ω
		between pins HVIO _n and GND; HVIO _n configured as low-side driver; $I_{HVIO_n} = 60\text{ mA}$	-	-	-	24	Ω
		between pins HVIO _n and GND; HVIO _n configured as low-side driver; $I_{HVIO_n} = 60\text{ mA}$; $T_{vj} = 175\text{ °C}$	-	-	-	27	Ω
ΔR_{on}	on-state resistance difference	between BATHSx and HVIO _n pairs; HVIO _n configured as high-side driver; $I_{HVIO_n} = -60\text{ mA}$	[5]	-	-	5	%
		between HVIO _n and GND pairs; HVIO _n configured as low-side driver; $I_{HVIO_n} = 60\text{ mA}$	-	-	-	10	%
$I_{O(sc)}$	short-circuit output current	peak value; HVIO _n configured as high-side driver; $V_{HVIO_n} = 0\text{ V}$	[2]	-1.3	-	-	A
		peak value; HVIO _n configured as low-side driver; $V_{HVIO_n} = 18\text{ V}$	[2]	-	-	1.3	A
I_L	leakage current	output drivers configured and off; $0\text{ V} < V_{HVIO_n} < 18\text{ V}$	[2]	-5	-	5	μA

Table 90. Static characteristics ...continued

$T_{vj} = -40\text{ °C to }+150\text{ °C}$; $V_{BATSMPS} = V_{BAT} = 2\text{ V to }28\text{ V}$; $V_{BATV2} = 5.5\text{ V to }28\text{ V}$; $V_{BATHS1} = V_{BATHS2} = 4.5\text{ V to }28\text{ V}$; $V_{VCAN} = 4.5\text{ V to }5.5\text{ V}$; $R_{LIN1} = R_{LIN2} = 500\text{ }\Omega$; $R_{(CANH-CANL)} = 60\text{ }\Omega$; $L_{SMPS}^{[1]} = 22\text{ }\mu\text{H}$; $C_{SMPS}^{[1]} = 22\text{ }\mu\text{F}$; $V_{VSMPS} = 6\text{ V}$ (SMPSOC = 0101); C_{V1} and $C_{VEXT} > 1.76\text{ }\mu\text{F}$; all voltages are defined with respect to ground; positive currents flow into the IC; typical values are given at $V_{BATSMPS} = V_{BAT} = V_{BATV2} = V_{BATHS1} = V_{BATHS2} = 13\text{ V}$ and $T_{vj} = 25\text{ °C}$; unless otherwise specified.

Symbol	Parameter	Conditions	Min	Typ	Max	Unit
$I_{th(det)sc}$	short-circuit detection threshold current	HVIO high-side driver				
		IOnSCTC = 00	-36	-30	-24	mA
		IOnSCTC = 01	-54	-45	-36	mA
		IOnSCTC = 10	-72	-60	-48	mA
		IOnSCTC = 11	-108	-90	-72	mA
		HVIO low-side driver				
		IOnSCTC = 00	24	30	36	mA
		IOnSCTC = 01	36	45	54	mA
		IOnSCTC = 10	48	60	72	mA
$I_{th(det)open}$	open load detection threshold current	HVIO high-side driver				
		IOnOLTC = 00	-4.1	-2	-1.25	mA
		IOnOLTC = 01	-7	-5	-4	mA
		IOnOLTC = 10	-13	-10	-8	mA
		IOnOLTC = 11	-25	-20	-16	mA
		HVIO low-side driver				
		IOnOLTC = 00	1.25	2	6	mA
		IOnOLTC = 01	4	5	9	mA
		IOnOLTC = 10	8	10	13	mA
$I_{sink(act)HVIO}$	HVIO activation sink current	HVIO configured as low-side driver with slope control (IOnCC = 010); $V_{HVIO} = 2.0\text{ V}$	70	125	170	mA
Battery monitoring; pins BAT and BATSENSE						
V_i	input voltage	Normal mode	2	-	20	V
$V_{ADC(acc)}$	ADC voltage accuracy	accuracy of ADC conversion results stored in bits BMBCD and BMSCD (see Section 7.8.2)	-300	0	+300	mV
Battery input filter capacitor; pin ADCCAP						
$R_{(BAT-ADCCAP)}$	resistance between pin BAT and pin ADCCAP		0.5	1	1.7	k Ω
MTP non-volatile memory						
$N_{cy(W)MTP}$	number of MTP write cycles		-	-	200	-
$V_{prog(MTPNV)}$	MTPNV programming voltage		[2] 6	-	28	V

Table 90. Static characteristics ...continued

$T_{vj} = -40\text{ °C to }+150\text{ °C}$; $V_{BATSMPS} = V_{BAT} = 2\text{ V to }28\text{ V}$; $V_{BATV2} = 5.5\text{ V to }28\text{ V}$; $V_{BATHS1} = V_{BATHS2} = 4.5\text{ V to }28\text{ V}$; $V_{VCAN} = 4.5\text{ V to }5.5\text{ V}$; $R_{LIN1} = R_{LIN2} = 500\text{ }\Omega$; $R_{(CANH-CANL)} = 60\text{ }\Omega$; $L_{SMPS}^{[1]} = 22\text{ }\mu\text{H}$; $C_{SMPS}^{[1]} = 22\text{ }\mu\text{F}$; $V_{VSMPS} = 6\text{ V}$ (SMPSOC = 0101); C_{V1} and $C_{VEXT} > 1.76\text{ }\mu\text{F}$; all voltages are defined with respect to ground; positive currents flow into the IC; typical values are given at $V_{BATSMPS} = V_{BAT} = V_{BATV2} = V_{BATHS1} = V_{BATHS2} = 13\text{ V}$ and $T_{vj} = 25\text{ °C}$; unless otherwise specified.

Symbol	Parameter	Conditions	Min	Typ	Max	Unit
Temperature protection						
$T_{th(act)otp}$	overtemperature protection activation threshold temperature		167	177	187	°C
$T_{th(rel)otp}$	overtemperature protection release threshold temperature		127	137	147	°C
$T_{th(warn)otp}$	overtemperature protection warning threshold temperature		127	137	147	°C

- [1] L_{SMPS} and C_{SMPS} are external components needed to configure the SMPS. See [Section 7.8.4](#).
- [2] Not tested in production; guaranteed by design.
- [3] The test circuit used to measure the bus output voltage symmetry (which includes C_{SPLIT}) is shown in [Figure 33](#).
- [4] $V_{VSMPS(nom)}$ is between 5 V and 8 V and is selected via bits SMPSOC (see [Table 24](#)).
- [5] When $x = 1$, $n = 1$ to 4; when $x = 2$, $n = 5$ to 8.





11. Dynamic characteristics

Table 91. Dynamic characteristics

$T_{vj} = -40\text{ °C to }+150\text{ °C}$; $V_{BATSMPS} = V_{BAT} = 2\text{ V to }28\text{ V}$; $V_{BATV2} = 5.5\text{ V to }28\text{ V}$; $V_{BATHS1} = V_{BATHS2} = 4.5\text{ V to }28\text{ V}$; $V_{VCAN} = 4.5\text{ V to }5.5\text{ V}$; $R_{LIN1} = R_{LIN2} = 500\text{ }\Omega$; $R_{(CANH-CANL)} = 60\text{ }\Omega$; $L_{SMPS}^{[1]} = 22\text{ }\mu\text{H}$; $C_{SMPS}^{[1]} = 22\text{ }\mu\text{F}$; $V_{VSMPS} = 6\text{ V}$ (SMPSOC = 0101); C_{V1} and $C_{VEXT} > 1.76\text{ }\mu\text{F}$; all voltages are defined with respect to ground; positive currents flow into the IC; typical values are given at $V_{BATSMPS} = V_{BAT} = V_{BATV2} = V_{BATHS1} = V_{BATHS2} = 13\text{ V}$ and $T_{vj} = 25\text{ °C}$; unless otherwise specified.

Symbol	Parameter	Conditions	Min	Typ	Max	Unit
SMPS						
f_{sw}	switching frequency		315	380	465	kHz
$t_{to(reg)}$	regulation time-out time	SMPS is set to 1 when V_{VSMPS} is outside the regulation window for longer than $t_{to(reg)}$	137	-	203	μs
$t_{d(act)}$	active mode delay time	minimum time SMPS spends in switched mode before a new mode transition can be attempted				
		Pass-through mode and ($I_{VSMPS} > I_{th(ocd)(VSMPS)}$) OR ($V_{UVD(BATSMPS)} > V_{BATSMPS} > V_{OVD(BATSMPS)}$)	0.9	1	1.1	ms
$t_{t(sw-pt)}$	transition time from switched mode to pass-through mode		2.7	3	3.3	ms
Battery supply						
$t_{startup}$	start-up time	from V_{BAT} exceeding the power-on detection threshold until V_{V1} exceeds the 90 % undervoltage threshold; $C_{V1} < 10\text{ }\mu\text{F}$; $-500\text{ mA} < I_{V1} < 0\text{ mA}$	-	1	2.1	ms
$t_{det(ov)}$	overvoltage detection time	from load dump/overvoltage threshold exceeded to OVSDI interrupt	400	-	480	ms
$t_{d(sd)ov}$	overvoltage shutdown delay time	after OVSDI interrupt	100	-	120	ms
Voltage source; pin V1						
$t_{det(uv)}$	undervoltage detection time	V_{V1} falling	6	-	39	μs
$t_{d(uvd-RSTNL)}$	delay time from undervoltage detection to RSTN LOW		-	-	40	μs
HS-CAN transceiver supply; pin VCAN						
$t_{det(uv)}$	undervoltage detection time	V_{VCAN} falling	6	-	32	μs
Voltage source; pin VEXT						
$t_{det(uv)}$	undervoltage detection time	V_{VEXT} falling	6	-	39	μs
		at start-up of VEXT; V_{VEXT} falling	2.2	2.5	2.8	ms
$t_{det(ov)}$	overvoltage detection time	V_{VEXT} rising	6	-	39	μs
Serial peripheral interface timing; pins SCSN, SCK, SDI and SDO						
$t_{cy(clk)}$	clock cycle time	$V_{V1} = 2.97\text{ V to }5.5\text{ V}$	250	-	-	ns
$t_{SPILEAD}$	SPI enable lead time	$V_{V1} = 2.97\text{ V to }5.5\text{ V}$	50	-	-	ns

Table 91. Dynamic characteristics ...continued

$T_{vj} = -40\text{ °C to }+150\text{ °C}$; $V_{BATSMPS} = V_{BAT} = 2\text{ V to }28\text{ V}$; $V_{BATV2} = 5.5\text{ V to }28\text{ V}$; $V_{BATHS1} = V_{BATHS2} = 4.5\text{ V to }28\text{ V}$; $V_{VCAN} = 4.5\text{ V to }5.5\text{ V}$; $R_{LIN1} = R_{LIN2} = 500\text{ }\Omega$; $R_{(CANH-CANL)} = 60\text{ }\Omega$; $L_{SMPS}^{[1]} = 22\text{ }\mu\text{H}$; $C_{SMPS}^{[1]} = 22\text{ }\mu\text{F}$; $V_{VSMPS} = 6\text{ V}$ (SMPSOC = 0101); C_{V1} and $C_{VEXT} > 1.76\text{ }\mu\text{F}$; all voltages are defined with respect to ground; positive currents flow into the IC; typical values are given at $V_{BATSMPS} = V_{BAT} = V_{BATV2} = V_{BATHS1} = V_{BATHS2} = 13\text{ V}$ and $T_{vj} = 25\text{ °C}$; unless otherwise specified.

Symbol	Parameter	Conditions	Min	Typ	Max	Unit
t_{SPILAG}	SPI enable lag time	$V_{V1} = 2.97\text{ V to }5.5\text{ V}$	50	-	-	ns
$t_{clk(H)}$	clock HIGH time	$V_{V1} = 2.97\text{ V to }5.5\text{ V}$	125	-	-	ns
$t_{clk(L)}$	clock LOW time	$V_{V1} = 2.97\text{ V to }5.5\text{ V}$	125	-	-	ns
$t_{su(D)}$	data input set-up time	$V_{V1} = 2.97\text{ V to }5.5\text{ V}$	50	-	-	ns
$t_{h(D)}$	data input hold time	$V_{V1} = 2.97\text{ V to }5.5\text{ V}$	50	-	-	ns
$t_{v(Q)}$	data output valid time	pin SDO; $V_{V1} = 2.97\text{ V to }5.5\text{ V}$; $C_L = 20\text{ pF}$	-	-	50	ns
$t_{WH(S)}$	chip select pulse width HIGH	$V_{V1} = 2.97\text{ V to }5.5\text{ V}$	250	-	-	ns
$t_{to(SPI)}$	SPI time-out time	after leaving Reset mode; $V_{V1} = 2.97\text{ V to }5.5\text{ V}$	-	-	53	μs
$t_{d(W)SPI}$	SPI write delay time	between two consecutive write access operations	-	-	10	μs
$t_{d(SCKL-SCSNL)}$	delay time from SCK LOW to SCSN LOW		50	-	-	ns

Reset output; pin RSTN

$t_{w(rst)}$	reset pulse width	output pulse width				
		RLC = 00	20	-	25	ms
		RLC = 01	10	-	12.5	ms
		RLC = 10	3.6	-	5	ms
		RLC = 11	1	-	1.5	ms
	input pulse width	18	-	-	μs	
$t_{to(rst)}$	reset time-out time		120	135	150	ms

Interrupt time-out; pin INTN1

$t_{to(int)}$	interrupt time-out time	INTN1 remains HIGH for at least $t_{to(int)}$ after being released	0.9	1	1.1	ms
---------------	-------------------------	--	-----	---	-----	----

High-voltage I/O: pins HVIO1 to HVIO8

$t_{w(wake)}$	wake-up pulse width	input configuration; interrupt enabled	51.5	-	-	μs
$f_{s(wake)}$	wake-up sampling frequency		55	-	142	kHz
$t_{det(fail)HVIO}$	HVIO failure detection time	open-load detection, HVIO already running	18	21	24	μs
		overcurrent detection, HVIO already running	12	27	30	μs
$t_{rec(fail)HVIO}$	HVIO failure recovery time	open-load recovery, HVIO already running	30	34	38	μs
$t_{d(on)HVIO}$	HVIO turn-on delay time	fast slope	36	40	44	μs
		slow slope	72	80	88	μs

Table 91. Dynamic characteristics ...continued

$T_{vj} = -40\text{ °C to }+150\text{ °C}$; $V_{BATSMPS} = V_{BAT} = 2\text{ V to }28\text{ V}$; $V_{BATV2} = 5.5\text{ V to }28\text{ V}$; $V_{BATHS1} = V_{BATHS2} = 4.5\text{ V to }28\text{ V}$; $V_{VCAN} = 4.5\text{ V to }5.5\text{ V}$; $R_{LIN1} = R_{LIN2} = 500\text{ }\Omega$; $R_{(CANH-CANL)} = 60\text{ }\Omega$; $L_{SMPS}^{[1]} = 22\text{ }\mu\text{H}$; $C_{SMPS}^{[1]} = 22\text{ }\mu\text{F}$; $V_{VSMPS} = 6\text{ V}$ (SMPSOC = 0101); C_{V1} and $C_{VEXT} > 1.76\text{ }\mu\text{F}$; all voltages are defined with respect to ground; positive currents flow into the IC; typical values are given at $V_{BATSMPS} = V_{BAT} = V_{BATV2} = V_{BATHS1} = V_{BATHS2} = 13\text{ V}$ and $T_{vj} = 25\text{ °C}$; unless otherwise specified.

Symbol	Parameter	Conditions	Min	Typ	Max	Unit
$t_{d(fdet-INTN1L)}$	delay time from failure detection to INTN1 LOW		-	8	9	μs
Battery monitoring: pins BAT, BATSENSE						
$t_{c(ADC)}$	ADC conversion time	time taken to measure and convert input voltage and store result in bits BMBCD or BMSCD (see Section 7.8.2); Normal mode; $0\text{ V} < V_{BAT} < 20\text{ V}$	5.4	6	6.6	μs
CAN transceiver timing; pins CANH, CANL, TXDC and RXDC						
$t_{d(TXDCH-RXDCH)}$	delay time from TXDC HIGH to RXDC HIGH	$70\% V_{TXDC}$ to $70\% V_{RXDC}$; $C_{RXDC} = 15\text{ pF}$; $f_{TXDC} = 250\text{ kHz}$; $R_{(CANH-CANL)} = 60\text{ }\Omega$; $C_{(CANH-CANL)} = 100\text{ pF}$;	-	-	255	ns
		$70\% V_{TXDC}$ to $70\% V_{RXDC}$; $C_{RXDC} = 15\text{ pF}$; $f_{TXDC} = 250\text{ kHz}$; $R_{(CANH-CANL)} = 120\text{ }\Omega$; $C_{(CANH-CANL)} = 200\text{ pF}$;	[2]	-	350	ns
$t_{d(TXDCL-RXDCL)}$	delay time from TXDC LOW to RXDC LOW	$30\% V_{TXDC}$ to $30\% V_{RXDC}$; $C_{RXDC} = 15\text{ pF}$; $f_{TXDC} = 250\text{ kHz}$; $R_{(CANH-CANL)} = 60\text{ }\Omega$; $C_{(CANH-CANL)} = 100\text{ pF}$;	-	-	255	ns
		$30\% V_{TXDC}$ to $30\% V_{RXDC}$; $C_{RXDC} = 15\text{ pF}$; $f_{TXDC} = 250\text{ kHz}$; $R_{(CANH-CANL)} = 120\text{ }\Omega$; $C_{(CANH-CANL)} = 200\text{ pF}$;	[2]	-	350	ns
$t_{d(TXDC-busdom)}$	delay time from TXDC to bus dominant		-	80	90	ns
$t_{d(TXDC-busrec)}$	delay time from TXDC to bus recessive		-	80	-	ns
$t_{d(busdom-RXDC)}$	delay time from bus dominant to RXDC	$C_{RXDC} = 15\text{ pF}$	-	105	-	ns
$t_{d(busrec-RXDC)}$	delay time from bus recessive to RXDC	$C_{RXDC} = 15\text{ pF}$	-	120	-	ns
$t_{bit(RXDC)}$	bit time on pin RXDC	$t_{bit(TXDC)} = 500\text{ ns}$ (see Figure 28); $C_{(CANH-CANL)} = 100\text{ pF}$	[2]	400	550	ns
$t_{wake(busdom)}$	bus dominant wake-up time	first pulse (after first recessive) for wake-up on pins CANH and CANL Sleep mode	0.5	-	3	μs
		second pulse for wake-up on pins CANH and CANL	0.5	-	3	μs
$t_{wake(busrec)}$	bus recessive wake-up time	first pulse for wake-up on pins CANH and CANL; Sleep mode	0.5	-	3	μs
		second pulse (after first dominant) for wake-up on pins CANH and CANL	0.5	-	3	μs

Table 91. Dynamic characteristics ...continued

$T_{vj} = -40\text{ }^{\circ}\text{C}$ to $+150\text{ }^{\circ}\text{C}$; $V_{BATSMPS} = V_{BAT} = 2\text{ V}$ to 28 V ; $V_{BATV2} = 5.5\text{ V}$ to 28 V ; $V_{BATHS1} = V_{BATHS2} = 4.5\text{ V}$ to 28 V ; $V_{VCAN} = 4.5\text{ V}$ to 5.5 V ; $R_{LIN1} = R_{LIN2} = 500\text{ }\Omega$; $R_{(CANH-CANL)} = 60\text{ }\Omega$; $L_{SMPS}^{[1]} = 22\text{ }\mu\text{H}$; $C_{SMPS}^{[1]} = 22\text{ }\mu\text{F}$; $V_{VSMPS} = 6\text{ V}$ (SMPSOC = 0101); C_{V1} and $C_{VEXT} > 1.76\text{ }\mu\text{F}$; all voltages are defined with respect to ground; positive currents flow into the IC; typical values are given at $V_{BATSMPS} = V_{BAT} = V_{BATV2} = V_{BATHS1} = V_{BATHS2} = 13\text{ V}$ and $T_{vj} = 25\text{ }^{\circ}\text{C}$; unless otherwise specified.

Symbol	Parameter	Conditions	Min	Typ	Max	Unit	
$t_{to(wake)}$	wake-up time-out time	between first and second dominant pulses; CAN Offline mode	570	-	850	μs	
$t_{to(dom)TXDC}$	TXDC dominant time-out time	CAN Active mode; $V_{TXDC} = 0\text{ V}$	0.8	3	5	ms	
$t_{to(silence)}$	bus silence time-out time	recessive time measurement started in all CAN modes	0.8	1	1.2	s	
$t_{d(busact-bias)}$	delay time from bus active to bias		-	-	200	μs	
$t_{d(act)CAN}$	CAN activation delay time	MC = 111; CAN entering CAN Active mode; $t_{d(act)norm}$ expired	-	-	24	μs	
LIN transceivers; pins LIN1, LIN2, TXDL1, TXDL2, RXDL1, RXDL2							
$\delta 1$	duty cycle 1	$V_{th(rec)(max)} = 0.744V_{BAT}$; $V_{th(dom)(max)} = 0.581V_{BAT}$; $t_{bit} = 50\text{ }\mu\text{s}$; $V_{BAT} = 7\text{ V}$ to 18 V	[3] [5] [6]	0.396	-	-	
		$V_{th(rec)(max)} = 0.768V_{BAT}$; $V_{th(dom)(max)} = 0.6V_{BAT}$; $t_{bit} = 50\text{ }\mu\text{s}$; $V_{BAT} = 5\text{ V}$ to 7 V	[3] [5] [6]	0.396	-	-	
$\delta 2$	duty cycle 2	$V_{th(rec)(min)} = 0.442V_{BAT}$; $V_{th(dom)(min)} = 0.284V_{BAT}$; $t_{bit} = 50\text{ }\mu\text{s}$; $V_{BAT} = 7.6\text{ V}$ to 18 V	[4] [5] [6]	-	-	0.581	
		$V_{th(rec)(min)} = 0.405V_{BAT}$; $V_{th(dom)(min)} = 0.271V_{BAT}$; $t_{bit} = 50\text{ }\mu\text{s}$; $V_{BAT} = 5.6\text{ V}$ to 7.6 V	[4] [5] [6]	-	-	0.581	
$\delta 3$	duty cycle 3	$V_{th(rec)(max)} = 0.778V_{BAT}$; $V_{th(dom)(max)} = 0.616V_{BAT}$; $t_{bit} = 96\text{ }\mu\text{s}$; $V_{BAT} = 7\text{ V}$ to 18 V	[3] [5] [6]	0.417	-	-	
		$V_{th(rec)(max)} = 0.805V_{BAT}$; $V_{th(dom)(max)} = 0.637V_{BAT}$; $t_{bit} = 96\text{ }\mu\text{s}$; $V_{BAT} = 5\text{ V}$ to 7 V	[3] [5] [6]	0.417	-	-	
$\delta 4$	duty cycle 4	$V_{th(rec)(min)} = 0.389V_{BAT}$; $V_{th(dom)(min)} = 0.251V_{BAT}$; $t_{bit} = 96\text{ }\mu\text{s}$; $V_{BAT} = 7.6\text{ V}$ to 18 V	[4] [5] [6]	-	-	0.590	
		$V_{th(rec)(min)} = 0.372V_{BAT}$; $V_{th(dom)(min)} = 0.238V_{BAT}$; $t_{bit} = 96\text{ }\mu\text{s}$; $V_{BAT} = 5.6\text{ V}$ to 7.6 V	[4] [5] [6]	-	-	0.590	
t_{rx_pd}	receiver propagation delay	rising and falling; $C_{RXD} = 20\text{ pF}$	[6]	-	-	6 μs	
t_{rx_sym}	receiver propagation delay symmetry	$C_{RXD} = 20\text{ pF}$; rising edge with respect to falling edge	[6]	-2	-	+2 μs	
$t_{wake(dom)LIN}$	LIN dominant wake-up time	LIN Offline mode	30	80	150	μs	
$t_{to(dom)TXDL}$	TXDL dominant time-out time	LIN Active mode; $V_{TXDL} = 0\text{ V}$	28	32	36	ms	

Table 91. Dynamic characteristics ...continued

$T_{vj} = -40\text{ °C to }+150\text{ °C}$; $V_{BATSMPS} = V_{BAT} = 2\text{ V to }28\text{ V}$; $V_{BATV2} = 5.5\text{ V to }28\text{ V}$; $V_{BATHS1} = V_{BATHS2} = 4.5\text{ V to }28\text{ V}$; $V_{VCAN} = 4.5\text{ V to }5.5\text{ V}$; $R_{LIN1} = R_{LIN2} = 500\text{ }\Omega$; $R_{(CANH-CANL)} = 60\text{ }\Omega$; $L_{SMPS}^{[1]} = 22\text{ }\mu\text{H}$; $C_{SMPS}^{[1]} = 22\text{ }\mu\text{F}$; $V_{VSMPS} = 6\text{ V}$ (SMPSOC = 0101); C_{V1} and $C_{VEXT} > 1.76\text{ }\mu\text{F}$; all voltages are defined with respect to ground; positive currents flow into the IC; typical values are given at $V_{BATSMPS} = V_{BAT} = V_{BATV2} = V_{BATHS1} = V_{BATHS2} = 13\text{ V}$ and $T_{vj} = 25\text{ °C}$; unless otherwise specified.

Symbol	Parameter	Conditions	Min	Typ	Max	Unit
Mode transition						
$t_{d(act)norm}$	normal mode activation delay time	MC = 111; delay before CAN and LIN transceivers, battery monitoring and HVIO low side drivers are activated after the SBC switches to Normal mode	-	-	320	μs
MTP non-volatile memory						
$t_{ret(data)}$	data retention time	$T_{vj} = 90\text{ °C}$	20	-	-	year
$t_{d(MTPNV)}$	MTPNV delay time	before factory presets are restored; $V_{RSTN} = 0\text{ V}$, $V_{CANL} = 0\text{ V}$ and $V_{CANH} > 5\text{ V}$ during power-up with $V_{BAT} = 6\text{ V to }28\text{ V}$	0.9	1	1.1	s
$t_{prog(MTPNV)}$	MTPNV programming time	correct CRC code received at address 0x75; $V_{BAT} = 6\text{ V to }28\text{ V}$	43	48	53	ms
Watchdog						
$t_{trig(wd)1}$	watchdog trigger time 1	Normal mode watchdog Window mode only ^[8]	$0.45 \times \text{NWP}^{[9]}$	-	$0.55 \times \text{NWP}^{[9]}$	ms
$t_{trig(wd)2}$	watchdog trigger time 2	Normal, Standby and Sleep modes; watchdog Window and Timeout modes ^[10]	$0.9 \times \text{NWP}^{[9]}$	-	$1.11 \times \text{NWP}^{[9]}$	ms
Timer						
T_{tmr}	timer period	$TnPC = 0000$ (4 ms selected)	3.67	4.08	4.49	ms
		$TnPC = 0001$ (8 ms selected)	7.34	8.16	8.98	ms
		$TnPC = 0010$ (20 ms selected)	18.36	20.40	22.44	ms
		$TnPC = 0011$ (30 ms selected)	25.70	28.56	31.42	ms
		$TnPC = 0100$ (50 ms selected)	44.06	48.96	53.86	ms
		$TnPC = 0101$ (100 ms selected)	88.12	97.92	107.72	ms
		$TnPC = 0110$ (200 ms selected)	176.25	195.84	215.43	ms
		$TnPC = 0111$ (400 ms selected)	352.51	391.68	430.85	ms
		$TnPC = 1000$ (800 ms selected)	705.02	783.36	861.70	ms
		$TnPC = 1001$ (1 s selected)	899.64	999.6	1099.56	ms
		$TnPC = 1010$ (2 s selected)	1799.28	1999.2	2199.12	ms
	$TnPC = 1011$ (4 s selected)	3598.56	3998.4	4398.24	ms	
$t_{w(base)tmr}$	timer base pulse width		86.4	96	105.6	μs

[1] L_{SMPS} and C_{SMPS} are external components needed to configure the SMPS. See [Section 7.8.4](#).

[2] Not tested in production; guaranteed by design.

[3] $\delta I, \delta 3 = \frac{t_{bus(rec)(min)}}{2 \times t_{bit}}$. Variable $t_{bus(rec)(min)}$ is illustrated in the LIN timing diagram in [Figure 29](#).

- [4] $\delta 2, \delta 4 = \frac{t_{bus(rec)(max)}}{2 \times t_{bit}}$. Variable $t_{bus(rec)(max)}$ is illustrated in the LIN timing diagram in [Figure 29](#).
- [5] Bus load conditions are: $C_L = 1 \text{ nF}$ and $R_L = 1 \text{ k}\Omega$; $C_L = 6.8 \text{ nF}$ and $R_L = 600 \Omega$; $C_L = 10 \text{ nF}$ and $R_L = 500 \Omega$.
- [6] See LIN timing diagram in [Figure 29](#).
- [7] $t_{rx_sym} = t_{rx_pdr} - t_{rx_pdf}$.
- [8] A system reset will be performed if the watchdog is in Window mode and is triggered earlier than $t_{trig(wd)1}$ after the start of the watchdog period (thus in the first half of the watchdog period).
- [9] The nominal watchdog period is programmed via the NWP control bits in the Watchdog control register ([Table 7](#)); valid in watchdog Window mode only.
- [10] The watchdog will be reset if it is in window mode and is triggered after $t_{trig(wd)1}$, but not later than $t_{trig(wd)2}$, after the start of the watchdog period (thus, in the second half of the watchdog period). If the watchdog is in Timeout mode, it will be reset if it is triggered within $t_{trig(wd)2}$ after the start of the watchdog period.



Fig 27. CAN transceiver timing diagram



Fig 28. CAN transceiver bit timing (loop symmetry) diagram

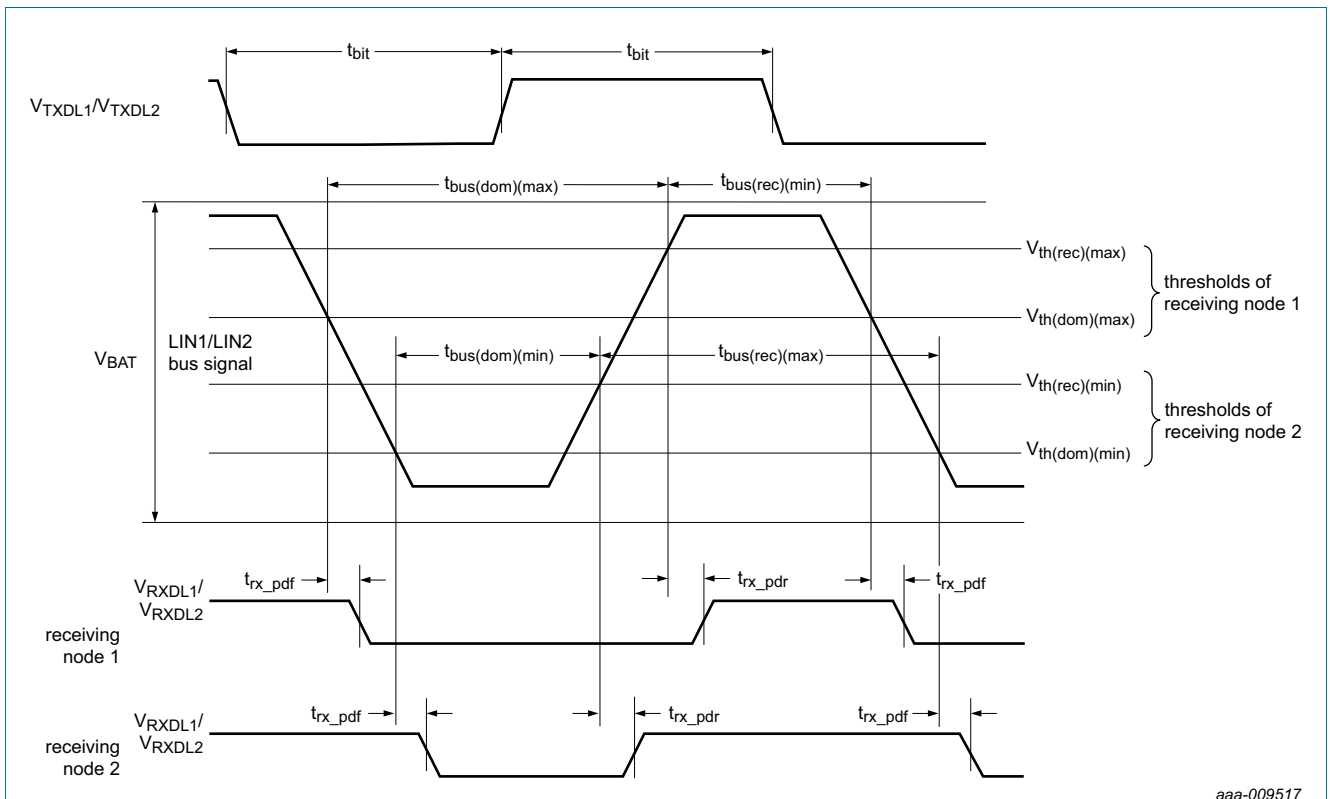

Fig 29. Timing diagram LIN transceivers



Fig 30. SPI timing diagram

12. Application information

12.1 Application diagram



12.2 Application hints

Further information on the application of the UJA113x series can be found in NXP application hints AH1506 'UJA113x Application Hints'.

13. Test information



13.1 Quality information

This product has been qualified in accordance with the Automotive Electronics Council (AEC) standard Q100 Rev-G - *Failure mechanism based stress test qualification for integrated circuits*, and is suitable for use in automotive applications.

14. Package outline

HTQFP48: plastic thermal enhanced thin quad flat package; 48 leads; body 10 x 10 x 1 mm; exposed die pad

SOT1181-2



Fig 35. Package outline SOT1181-2 (HTQFP48)

15. Handling information

All input and output pins are protected against ElectroStatic Discharge (ESD) under normal handling. When handling ensure that the appropriate precautions are taken as described in *JESD625-A* or equivalent standards.

16. Soldering of SMD packages

This text provides a very brief insight into a complex technology. A more in-depth account of soldering ICs can be found in Application Note *AN10365 "Surface mount reflow soldering description"*.

16.1 Introduction to soldering

Soldering is one of the most common methods through which packages are attached to Printed Circuit Boards (PCBs), to form electrical circuits. The soldered joint provides both the mechanical and the electrical connection. There is no single soldering method that is ideal for all IC packages. Wave soldering is often preferred when through-hole and Surface Mount Devices (SMDs) are mixed on one printed wiring board; however, it is not suitable for fine pitch SMDs. Reflow soldering is ideal for the small pitches and high densities that come with increased miniaturization.

16.2 Wave and reflow soldering

Wave soldering is a joining technology in which the joints are made by solder coming from a standing wave of liquid solder. The wave soldering process is suitable for the following:

- Through-hole components
- Leaded or leadless SMDs, which are glued to the surface of the printed circuit board

Not all SMDs can be wave soldered. Packages with solder balls, and some leadless packages which have solder lands underneath the body, cannot be wave soldered. Also, leaded SMDs with leads having a pitch smaller than ~0.6 mm cannot be wave soldered, due to an increased probability of bridging.

The reflow soldering process involves applying solder paste to a board, followed by component placement and exposure to a temperature profile. Leaded packages, packages with solder balls, and leadless packages are all reflow solderable.

Key characteristics in both wave and reflow soldering are:

- Board specifications, including the board finish, solder masks and vias
- Package footprints, including solder thieves and orientation
- The moisture sensitivity level of the packages
- Package placement
- Inspection and repair
- Lead-free soldering versus SnPb soldering

16.3 Wave soldering

Key characteristics in wave soldering are:

- Process issues, such as application of adhesive and flux, clinching of leads, board transport, the solder wave parameters, and the time during which components are exposed to the wave
- Solder bath specifications, including temperature and impurities

16.4 Reflow soldering

Key characteristics in reflow soldering are:

- Lead-free versus SnPb soldering; note that a lead-free reflow process usually leads to higher minimum peak temperatures (see [Figure 36](#)) than a SnPb process, thus reducing the process window
- Solder paste printing issues including smearing, release, and adjusting the process window for a mix of large and small components on one board
- Reflow temperature profile; this profile includes preheat, reflow (in which the board is heated to the peak temperature) and cooling down. It is imperative that the peak temperature is high enough for the solder to make reliable solder joints (a solder paste characteristic). In addition, the peak temperature must be low enough that the packages and/or boards are not damaged. The peak temperature of the package depends on package thickness and volume and is classified in accordance with [Table 92](#) and [93](#)

Table 92. SnPb eutectic process (from J-STD-020D)

Package thickness (mm)	Package reflow temperature (°C)	
	Volume (mm ³)	
	< 350	≥ 350
< 2.5	235	220
≥ 2.5	220	220

Table 93. Lead-free process (from J-STD-020D)

Package thickness (mm)	Package reflow temperature (°C)		
	Volume (mm ³)		
	< 350	350 to 2000	> 2000
< 1.6	260	260	260
1.6 to 2.5	260	250	245
> 2.5	250	245	245

Moisture sensitivity precautions, as indicated on the packing, must be respected at all times.

Studies have shown that small packages reach higher temperatures during reflow soldering, see [Figure 36](#).

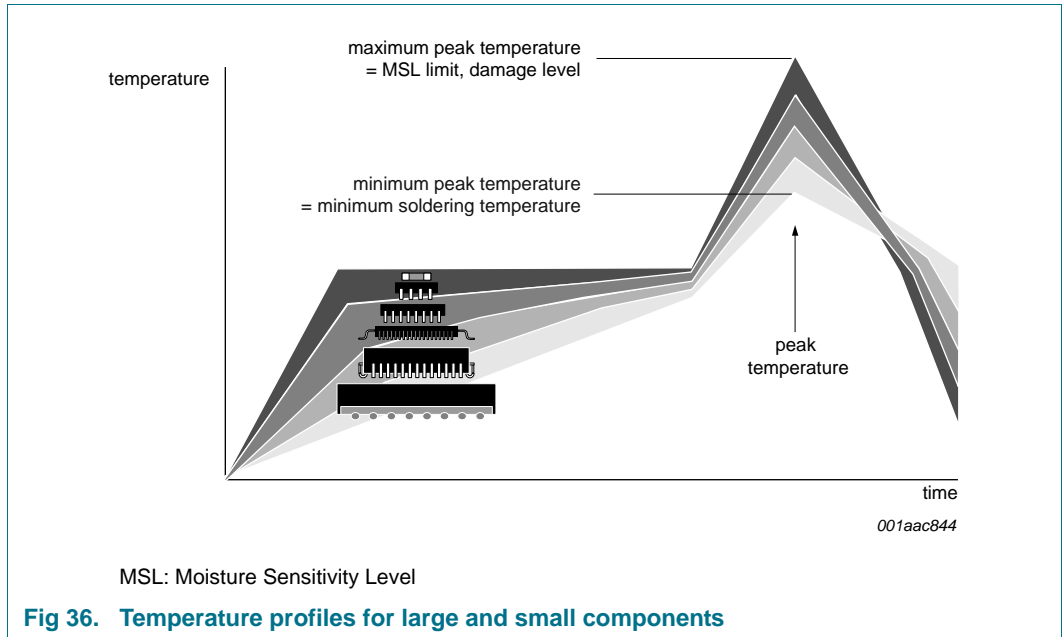

For further information on temperature profiles, refer to Application Note AN10365 “Surface mount reflow soldering description”.

17. Revision history

Table 94. Revision history

Document ID	Release date	Data sheet status	Change notice	Supersedes
UJA113x_SER_2.2	20160705	Product data sheet	-	UJA113x_SER_1
Modifications:	<ul style="list-style-type: none"> • Table 2: Table note 2 deleted • Figure 2, Figure 4, Figure 5, Figure 9, Figure 15: revised • Table 49, Table 51, Table 53, Table 55: TxDCC access code corrected (to R/W) • Section 7.16.1: text amended (paragraph added) • Table 88: measurement conditions changed for parameters V_x (DC value removed) and V_{trt} (HVIOx coupling); Table note 1 added • Table 90: supply current (I_{DD}) section revised; values for additional I_{DD} current in Offline Bias mode changed • Figure 31: value of one of the HVIOx capacitors changed • Section 12.2 added 			
UJA113x_SER_1	20150611	Product data sheet	-	-

18. Legal information

18.1 Data sheet status

Document status ^{[1][2]}	Product status ^[3]	Definition
Objective [short] data sheet	Development	This document contains data from the objective specification for product development.
Preliminary [short] data sheet	Qualification	This document contains data from the preliminary specification.
Product [short] data sheet	Production	This document contains the product specification.

[1] Please consult the most recently issued document before initiating or completing a design.

[2] The term 'short data sheet' is explained in section "Definitions".

[3] The product status of device(s) described in this document may have changed since this document was published and may differ in case of multiple devices. The latest product status information is available on the Internet at URL <http://www.nxp.com>.

18.2 Definitions

Draft — The document is a draft version only. The content is still under internal review and subject to formal approval, which may result in modifications or additions. NXP Semiconductors does not give any representations or warranties as to the accuracy or completeness of information included herein and shall have no liability for the consequences of use of such information.

Short data sheet — A short data sheet is an extract from a full data sheet with the same product type number(s) and title. A short data sheet is intended for quick reference only and should not be relied upon to contain detailed and full information. For detailed and full information see the relevant full data sheet, which is available on request via the local NXP Semiconductors sales office. In case of any inconsistency or conflict with the short data sheet, the full data sheet shall prevail.

Product specification — The information and data provided in a Product data sheet shall define the specification of the product as agreed between NXP Semiconductors and its customer, unless NXP Semiconductors and customer have explicitly agreed otherwise in writing. In no event however, shall an agreement be valid in which the NXP Semiconductors product is deemed to offer functions and qualities beyond those described in the Product data sheet.

18.3 Disclaimers

Limited warranty and liability — Information in this document is believed to be accurate and reliable. However, NXP Semiconductors does not give any representations or warranties, expressed or implied, as to the accuracy or completeness of such information and shall have no liability for the consequences of use of such information. NXP Semiconductors takes no responsibility for the content in this document if provided by an information source outside of NXP Semiconductors.

In no event shall NXP Semiconductors be liable for any indirect, incidental, punitive, special or consequential damages (including - without limitation - lost profits, lost savings, business interruption, costs related to the removal or replacement of any products or rework charges) whether or not such damages are based on tort (including negligence), warranty, breach of contract or any other legal theory.

Notwithstanding any damages that customer might incur for any reason whatsoever, NXP Semiconductors' aggregate and cumulative liability towards customer for the products described herein shall be limited in accordance with the *Terms and conditions of commercial sale* of NXP Semiconductors.

Right to make changes — NXP Semiconductors reserves the right to make changes to information published in this document, including without limitation specifications and product descriptions, at any time and without notice. This document supersedes and replaces all information supplied prior to the publication hereof.

Suitability for use in automotive applications — This NXP Semiconductors product has been qualified for use in automotive applications. Unless otherwise agreed in writing, the product is not designed, authorized or warranted to be suitable for use in life support, life-critical or safety-critical systems or equipment, nor in applications where failure or malfunction of an NXP Semiconductors product can reasonably be expected to result in personal injury, death or severe property or environmental damage. NXP Semiconductors and its suppliers accept no liability for inclusion and/or use of NXP Semiconductors products in such equipment or applications and therefore such inclusion and/or use is at the customer's own risk.

Applications — Applications that are described herein for any of these products are for illustrative purposes only. NXP Semiconductors makes no representation or warranty that such applications will be suitable for the specified use without further testing or modification.

Customers are responsible for the design and operation of their applications and products using NXP Semiconductors products, and NXP Semiconductors accepts no liability for any assistance with applications or customer product design. It is customer's sole responsibility to determine whether the NXP Semiconductors product is suitable and fit for the customer's applications and products planned, as well as for the planned application and use of customer's third party customer(s). Customers should provide appropriate design and operating safeguards to minimize the risks associated with their applications and products.

NXP Semiconductors does not accept any liability related to any default, damage, costs or problem which is based on any weakness or default in the customer's applications or products, or the application or use by customer's third party customer(s). Customer is responsible for doing all necessary testing for the customer's applications and products using NXP Semiconductors products in order to avoid a default of the applications and the products or of the application or use by customer's third party customer(s). NXP does not accept any liability in this respect.

Limiting values — Stress above one or more limiting values (as defined in the Absolute Maximum Ratings System of IEC 60134) will cause permanent damage to the device. Limiting values are stress ratings only and (proper) operation of the device at these or any other conditions above those given in the Recommended operating conditions section (if present) or the Characteristics sections of this document is not warranted. Constant or repeated exposure to limiting values will permanently and irreversibly affect the quality and reliability of the device.

Terms and conditions of commercial sale — NXP Semiconductors products are sold subject to the general terms and conditions of commercial sale, as published at <http://www.nxp.com/profile/terms>, unless otherwise agreed in a valid written individual agreement. In case an individual agreement is concluded only the terms and conditions of the respective agreement shall apply. NXP Semiconductors hereby expressly objects to applying the customer's general terms and conditions with regard to the purchase of NXP Semiconductors products by customer.

No offer to sell or license — Nothing in this document may be interpreted or construed as an offer to sell products that is open for acceptance or the grant, conveyance or implication of any license under any copyrights, patents or other industrial or intellectual property rights.

Export control — This document as well as the item(s) described herein may be subject to export control regulations. Export might require a prior authorization from competent authorities.

Translations — A non-English (translated) version of a document is for reference only. The English version shall prevail in case of any discrepancy between the translated and English versions.

18.4 Trademarks

Notice: All referenced brands, product names, service names and trademarks are the property of their respective owners.

19. Contact information

For more information, please visit: <http://www.nxp.com>

For sales office addresses, please send an email to: salesaddresses@nxp.com

20. Contents

1	General description	1	7.6	Global temperature protection	28
2	Features and benefits	2	7.7	Register locking	29
2.1	General	2	7.8	Power supplies	30
2.2	Integrated buck and boost converter (SMPS)	2	7.8.1	Battery supply pins	30
2.3	Low-drop voltage regulators (LDOs)	3	7.8.2	Battery monitor	30
2.4	CAN transceiver	3	7.8.3	Overvoltage shut-down	33
2.5	LIN transceivers	3	7.8.4	Buck and Boost converter (SMPS)	33
2.6	High-voltage I/Os (HVIOs; not available in UJA113xFD/0 variants)	4	7.8.4.1	SMPS parameter selection and status monitoring	33
2.7	A/D converter for monitoring the battery voltage	4	7.8.4.2	Automatic up/down principle	35
2.8	Power management	5	7.8.4.3	Start-up and inrush currents	36
2.9	System control and diagnostic features	5	7.8.4.4	Pass-through mode operation	36
3	Product family overview	6	7.8.4.5	Transitions to and from Pass-through mode	37
4	Ordering information	7	7.8.4.6	Overload protection	39
5	Block diagram	8	7.8.5	Linear regulators	40
6	Pinning information	10	7.8.5.1	V1 regulator	40
6.1	Pinning	10	7.8.5.2	Voltage regulator V2	40
6.2	Pin description	10	7.8.5.3	Regulator control register	41
7	Functional description	12	7.9	CAN and LIN bus transceivers	42
7.1	System Controller	12	7.9.1	High-speed CAN transceiver	42
7.1.1	Operating modes	12	7.9.1.1	CAN operating modes	42
7.1.1.1	Off mode	12	7.9.1.2	CAN standard wake-up (partial networking not enabled)	45
7.1.1.2	Standby mode	13	7.9.1.3	CAN partial networking (UJ113xFD only)	46
7.1.1.3	Normal mode	13	7.9.1.4	Fail-safe features	49
7.1.1.4	Sleep mode	14	7.9.2	LIN transceiver(s)	49
7.1.1.5	Overload mode	15	7.9.2.1	LIN 2.x/SAE J2602 compliant	50
7.1.1.6	Reset mode	15	7.9.3	LIN operating modes	50
7.1.1.7	Forced Sleep Preparation (FSP) mode	16	7.9.3.1	LIN Active mode	51
7.1.1.8	Forced Normal mode	16	7.9.3.2	LIN Offline mode	51
7.1.1.9	Hardware characterization for the SBC operating modes	16	7.9.3.3	LIN Listen-only mode	52
7.1.2	System control registers	18	7.9.3.4	LIN Off mode	52
7.2	Watchdog	19	7.9.4	Fail-safe features	52
7.2.1	Software development mode	22	7.9.4.1	General fail-safe features	52
7.2.2	Watchdog behavior in Window mode	22	7.9.4.2	TXDL dominant time-out	53
7.2.3	Watchdog behavior in Timeout mode	22	7.9.5	LIN slope control	53
7.2.4	Watchdog behavior in Autonomous mode	22	7.9.6	Operation when supply voltage is outside specified operating range	53
7.2.5	Exceptional behavior of the watchdog after writing to the Watchdog register	23	7.9.7	Transceiver control and status registers	54
7.3	System reset	24	7.9.8	CAN partial networking configuration registers	57
7.3.1	Characteristics of pin RSTN	25	7.10	High-voltage input/output pins (HVIOs; not available in UJA113xFD/0)	60
7.3.2	Selecting the output reset pulse width	25	7.10.1	HVIO configuration	60
7.3.3	Reset sources	26	7.10.1.1	HVIO slope control	62
7.4	EN output	27	7.10.2	Direct control of HVIOs (only valid for variants with 8 HVIO pins)	62
7.4.1	Fail-safe control register	27	7.10.3	Short-circuit and open load detection	62
7.5	Limp home function	28	7.10.4	Automatic load shedding	63

continued >>