

US5AC-HF Thru. US5MC-HF

Reverse Voltage: 50 to 1000 Volts

Forward Current: 5 Amp

RoHS Device

Halogen Free

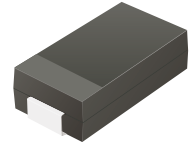

Features

- For surface mounted applications.
- Low profile package.
- Glass passivated chip junction.

Mechanical data

- Case: SMC
- Terminals: Solderable per MIL-STD-750, method 2026.

Circuit Diagram

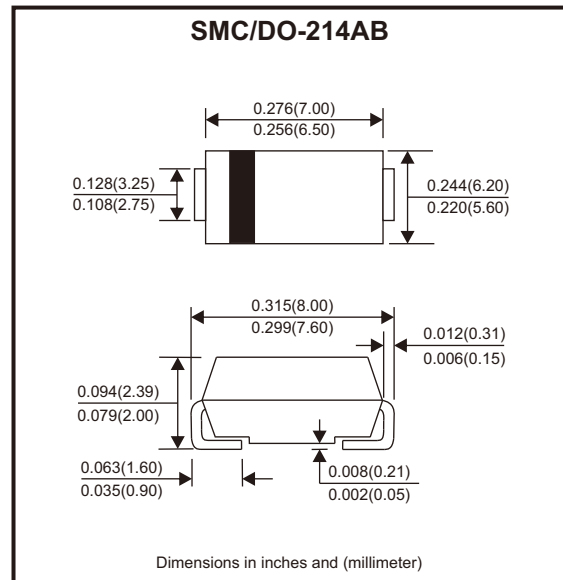

Maximum Ratings and Electrical Characteristics

Ratings at 25°C ambient temperature unless otherwise specified.

Single phase, half wave, 60Hz resistive or inductive load, for capacitive load, derate by 20%

| Parameter | Symbols | US5AC -HF | US5BC -HF | US5DC -HF | US5GC -HF | US5JC -HF | US5KC -HF | US5MC -HF | Units |
|--|-----------------|--------------|--------------|--------------|--------------|--------------|--------------|--------------|--------------------|
| Maximum repetitive peak reverse voltage | V_{RRM} | 50 | 100 | 200 | 400 | 600 | 800 | 1000 | V |
| Maximum RMS voltage | V_{RMS} | 35 | 70 | 140 | 280 | 420 | 560 | 700 | V |
| Maximum DC blocking voltage | V_{DC} | 50 | 100 | 200 | 400 | 600 | 800 | 1000 | V |
| Maximum average forward rectified current at $T_c = 100^\circ\text{C}$ | $I_{F(AV)}$ | 5 | | | | | | | A |
| Peak forward surge current, 8.3ms single half sine-wave superimposed on rated load | I_{FSM} | 120 | | | | | | | A |
| Max. instantaneous forward voltage at 5A | V_F | 1.0 | | | 1.3 | 1.65 | | V | |
| Maximum DC reverse current at rated DC blocking voltage | I_R | 5 100 | | | | | | | μA |
| Typical junction capacitance at $V_R = 4\text{V}$, $f = 1\text{MHz}$ | C_j | 50 | | | | | | | pF |
| Maximum reverse recovery time (Note 1) | t_{rr} | 50 | | | | 75 | | | ns |
| Typical thermal resistance (Note 2) | $R_{\theta JA}$ | 35 | | | | | | | $^\circ\text{C/W}$ |
| Operating and storage temperature range | T_j, T_{stg} | -55 ~ +150 | | | | | | | $^\circ\text{C}$ |

Notes: 1. Measured with $I_F = 0.5\text{A}$, $I_R = 1\text{A}$, $I_{rr} = 0.25\text{A}$.

2. P.C.B. mounted with 2.0" x 2.0" (5 x 5 cm) copper pad areas.

Company reserves the right to improve product design, functions and reliability without notice.

REV:A

Rating and Characteristic Curves (US5AC-HF Thru. US5MC-HF)

Fig.1 - Max. Average Forward Current Rating

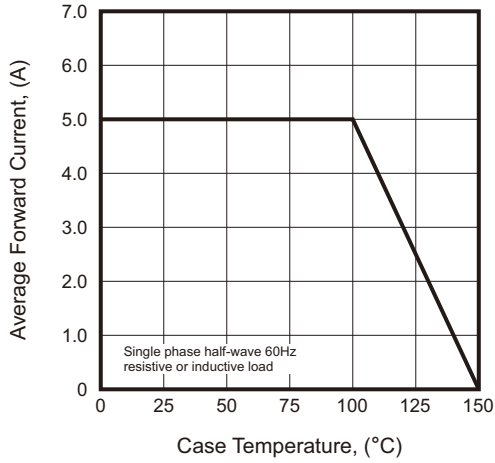

Fig.2 - Typical Reverse Characteristics

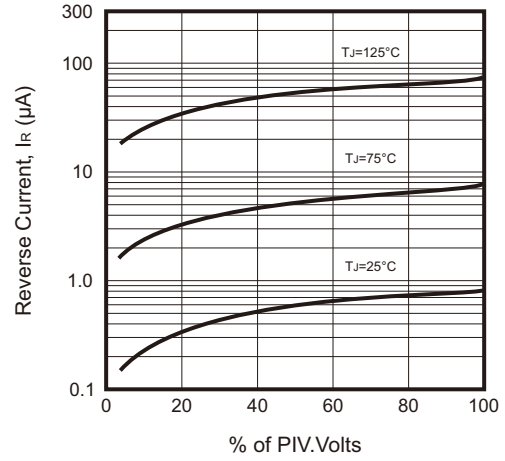

Fig.3 - Typical Forward Characteristic

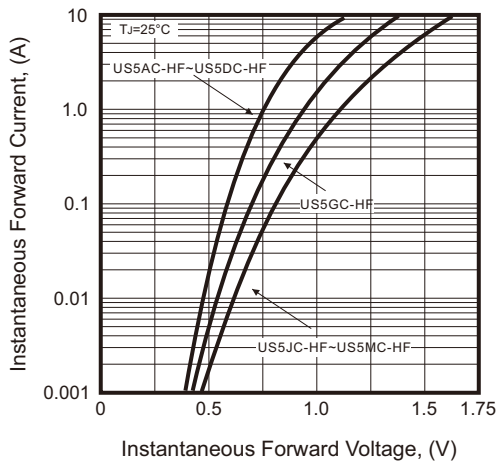

Fig.4 - Typical Junction Capacitance

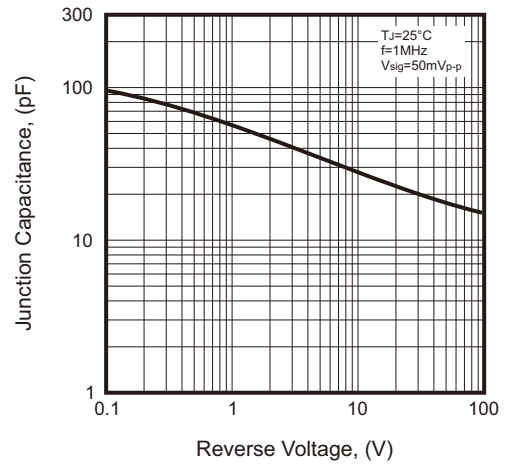
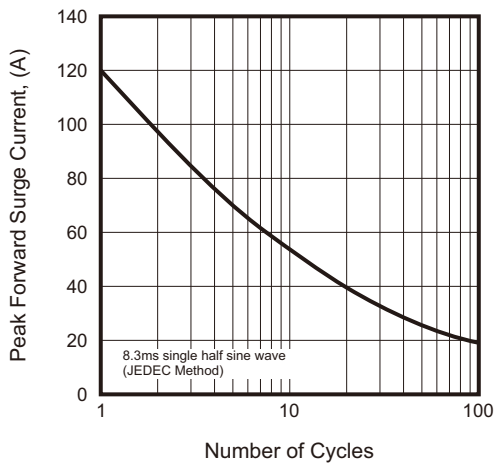

Fig.5 - Maximum Non-Repetitive Peak Forward Surge Current



Company reserves the right to improve product design, functions and reliability without notice.

REV:A

Reel Taping Specification

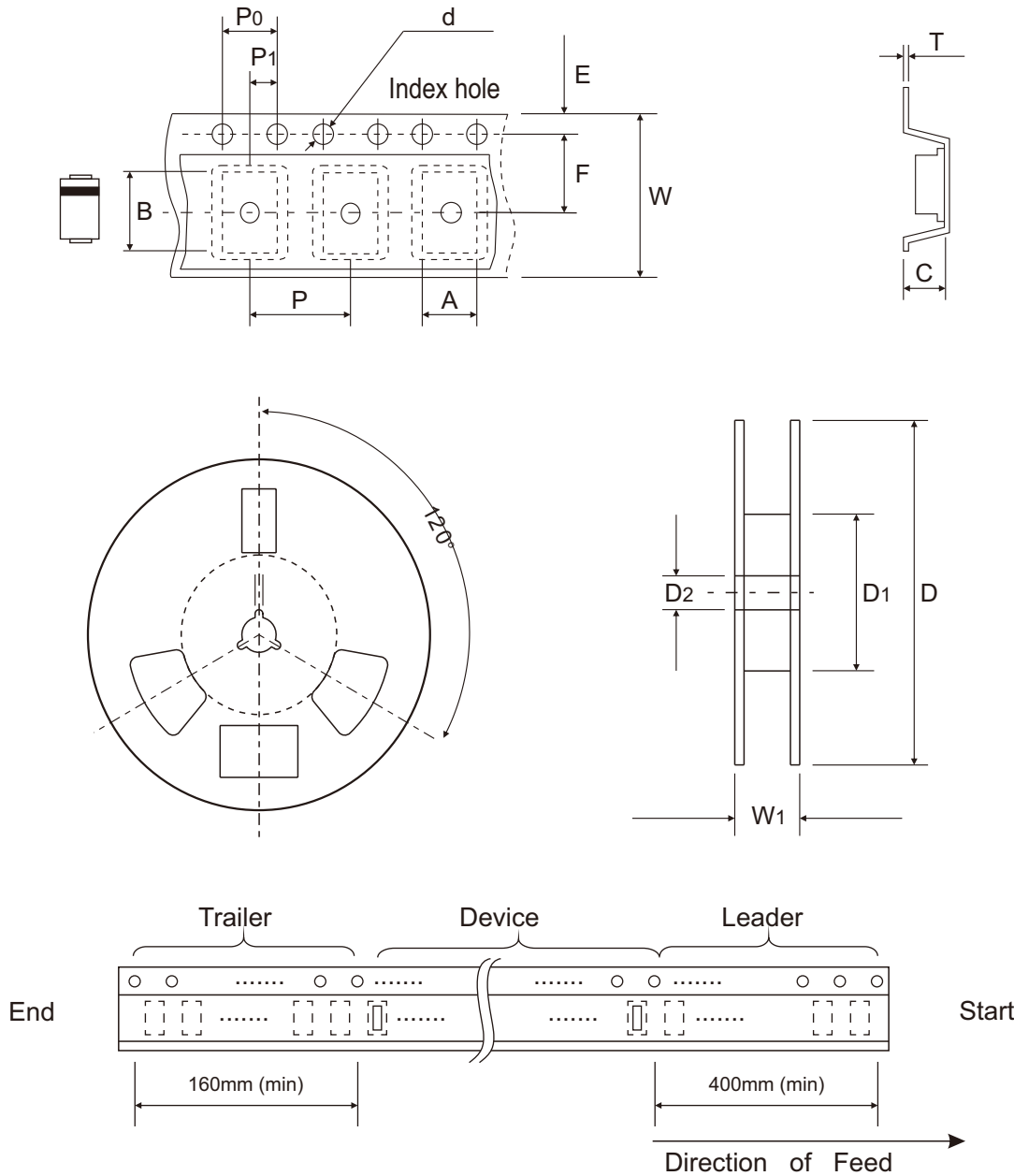

| DO-214AB (SMC) | SYMBOL | A | B | C | d | D | D1 | D2 |
|-------------------|--------|---------------|---------------|---------------|---------------|----------------|---------------|---------------|
| | (mm) | 6.22 ± 0.10 | 8.31 ± 0.10 | 2.49 ± 0.10 | 1.55 ± 0.05 | 330 ± 2.00 | 100.00 ± 1.00 | 13.00 ± 0.20 |
| | (inch) | 0.245 ± 0.004 | 0.327 ± 0.004 | 0.098 ± 0.004 | 0.061 ± 0.002 | 12.992 ± 0.079 | 3.937 ± 0.039 | 0.512 ± 0.008 |

| DO-214AB (SMC) | SYMBOL | E | F | P | P0 | P1 | T | W | W1 |
|-------------------|--------|---------------|---------------|---------------|---------------|---------------|---------------|---------------|--------------------------|
| | (mm) | 1.75 ± 0.10 | 7.50 ± 0.10 | 8.00 ± 0.10 | 4.00 ± 0.10 | 2.00 ± 0.05 | 0.28 ± 0.02 | 16.00 ± 0.30 | 21.00 + 2.00 - 1.00 |
| | (inch) | 0.069 ± 0.004 | 0.295 ± 0.004 | 0.315 ± 0.004 | 0.157 ± 0.004 | 0.079 ± 0.002 | 0.011 ± 0.001 | 0.630 ± 0.012 | 0.827 + 0.079 - 0.039 |

Company reserves the right to improve product design , functions and reliability without notice.

REV:A