

US5AC-HF Thru. US5MC-HF

Reverse Voltage: 50 to 1000 Volts

Forward Current: 5 Amp

RoHS Device

Halogen Free

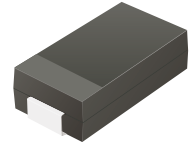

Features

- For surface mounted applications.
- Low profile package.
- Glass passivated chip junction.

Mechanical data

- Case: SMC
- Terminals: Solderable per MIL-STD-750, method 2026.

Circuit Diagram

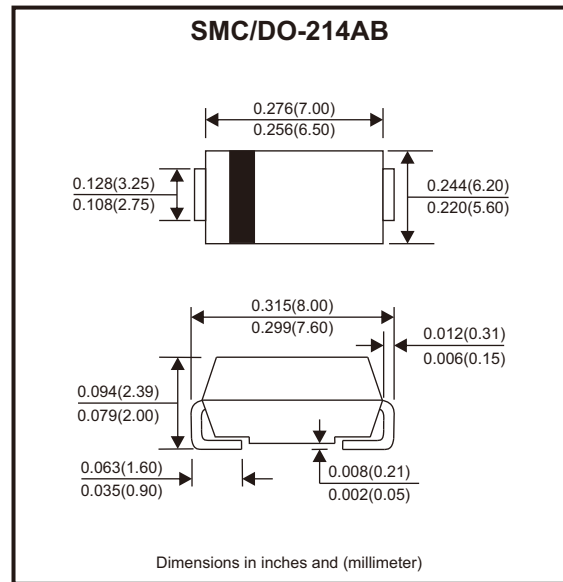

Maximum Ratings and Electrical Characteristics

Ratings at 25°C ambient temperature unless otherwise specified.

Single phase, half wave, 60Hz resistive or inductive load, for capacitive load, derate by 20%

Parameter	Symbols	US5AC-HF	US5BC-HF	US5DC-HF	US5GC-HF	US5JC-HF	US5KC-HF	US5MC-HF	Units
Maximum repetitive peak reverse voltage	V_{RRM}	50	100	200	400	600	800	1000	V
Maximum RMS voltage	V_{RMS}	35	70	140	280	420	560	700	V
Maximum DC blocking voltage	V_{DC}	50	100	200	400	600	800	1000	V
Maximum average forward rectified current at $T_c = 100^\circ\text{C}$	$I_{F(AV)}$	5							A
Peak forward surge current, 8.3ms single half sine-wave superimposed on rated load	I_{FSM}	120							A
Max. instantaneous forward voltage at 5A	V_F	1.0			1.3	1.65		V	
Maximum DC reverse current at rated DC blocking voltage	I_R	5 100							μA
Typical junction capacitance at $V_R = 4\text{V}$, $f = 1\text{MHz}$	C_j	50							pF
Maximum reverse recovery time (Note 1)	t_{rr}	50				75			ns
Typical thermal resistance (Note 2)	$R_{\theta JA}$	35							$^\circ\text{C/W}$
Operating and storage temperature range	T_j, T_{stg}	-55 ~ +150							$^\circ\text{C}$

Notes: 1. Measured with $I_F = 0.5\text{A}$, $I_R = 1\text{A}$, $I_{rr} = 0.25\text{A}$.

2. P.C.B. mounted with 2.0" x 2.0" (5 x 5 cm) copper pad areas.

Company reserves the right to improve product design, functions and reliability without notice.

REV:A

Rating and Characteristic Curves (US5AC-HF Thru. US5MC-HF)

Fig.1 - Max. Average Forward Current Rating

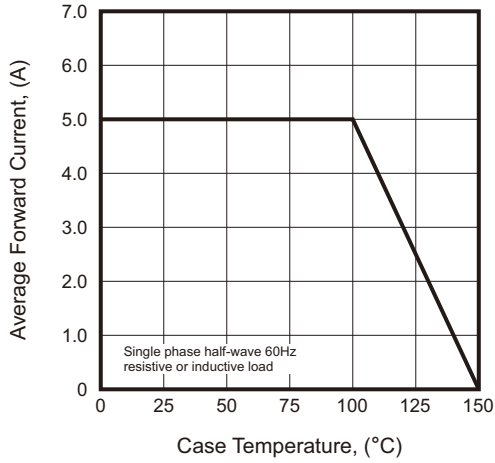

Fig.2 - Typical Reverse Characteristics

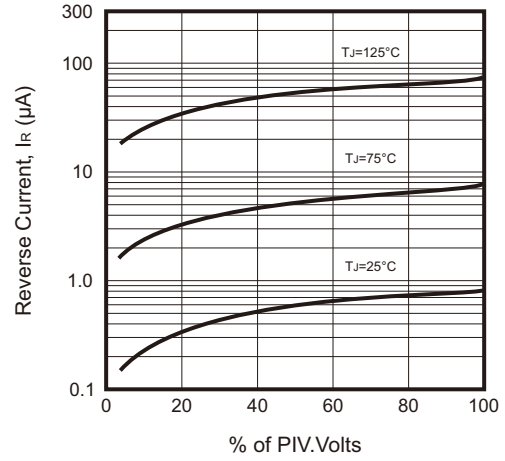

Fig.3 - Typical Forward Characteristic

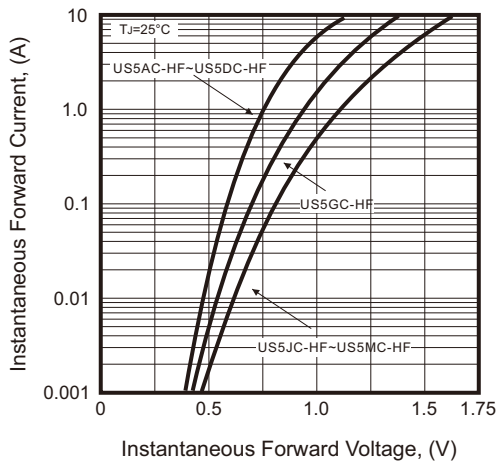

Fig.4 - Typical Junction Capacitance

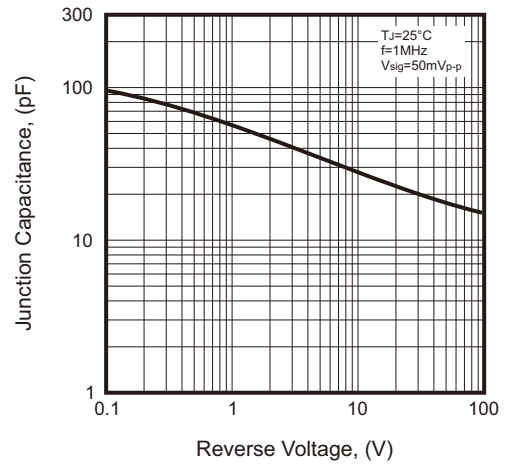
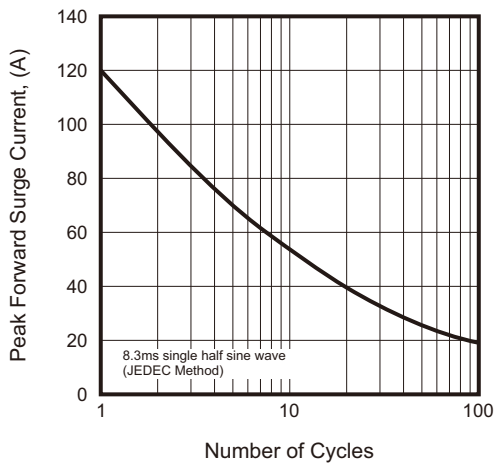
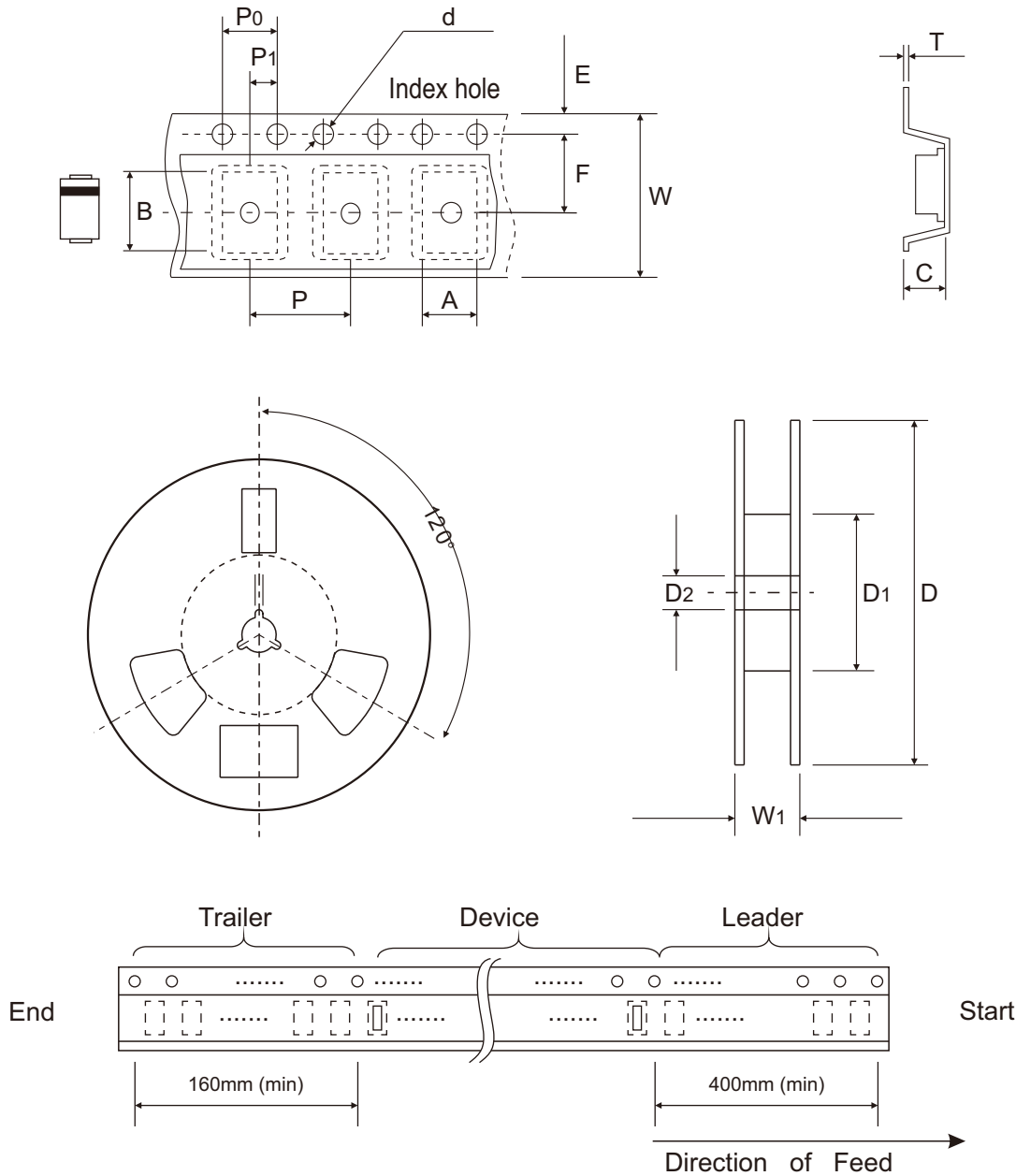

Fig.5 - Maximum Non-Repetitive Peak Forward Surge Current



Reel Taping Specification



DO-214AB (SMC)	SYMBOL	A	B	C	d	D	D1	D2
	(mm)	6.22 ± 0.10	8.31 ± 0.10	2.49 ± 0.10	1.55 ± 0.05	330 ± 2.00	100.00 ± 1.00	13.00 ± 0.20
	(inch)	0.245 ± 0.004	0.327 ± 0.004	0.098 ± 0.004	0.061 ± 0.002	12.992 ± 0.079	3.937 ± 0.039	0.512 ± 0.008

DO-214AB (SMC)	SYMBOL	E	F	P	P0	P1	T	W	W1
	(mm)	1.75 ± 0.10	7.50 ± 0.10	8.00 ± 0.10	4.00 ± 0.10	2.00 ± 0.05	0.28 ± 0.02	16.00 ± 0.30	21.00 + 2.00 - 1.00
	(inch)	0.069 ± 0.004	0.295 ± 0.004	0.315 ± 0.004	0.157 ± 0.004	0.079 ± 0.002	0.011 ± 0.001	0.630 ± 0.012	0.827 + 0.079 - 0.039

Company reserves the right to improve product design, functions and reliability without notice.

REV:A