

EMI

ENCLOSURE SHIELDING SOLUTIONS



**LEADER
TECH** 
a HEICO company

The Leading Edge in EMI Shielding Technology



SHIELDING SELECTION CONSIDERATIONS

Consider these important factors in the selection of appropriate shielding products for your design:

- n Operating Frequency
- n Materials Compatibility
- n Load/Forces
- n Corrosive Considerations
- n Commercial or Military Worldwide Compliance
- n Operating Environment
- n Cycle Life
- n Cost
- n Material Thickness/Alloy
- n Attenuation Performance
- n Fastening/Mounting Methods
- n Storage Environment
- n Nuclear, Biological, Chemical (NBC)
- n Shielding/Grounding/Other
- n Electrical Requirements
- n Space/Weight Considerations
- n Product Safety
- n Recyclability

QUICK REFERENCE PRODUCT SELECTION CHART

| PARAMETERS | TechSIL ELASTOMER SHEETS | TechSIL ELASTOMER GASKETS | CuBe METAL GASKETS | FSG FABRIC SHIELDING GASKETS | CFS CONDUCTIVE FOAM | TechMESH KNITTED WIRE | TechMESH COMBO STRIP |
|----------------------|--------------------------|---------------------------|--------------------|------------------------------|---------------------|-----------------------|----------------------|
| High Cycling | Good | Good | Excellent | Very Good | Fair | Good | Good |
| Wiping Applications | N/A | Good | Excellent | Good | N/A | Fair | Fair |
| Dust Protection | Excellent | Excellent | N/A | Very Good | Very Good | Fair | Excellent |
| Moisture Protection | Excellent | Excellent | N/A | N/A | N/A | N/A | Excellent |
| Deflection % | 10-20% | 15-50% | 15-85% | 30-50% | 30-60% | 20-50% | 20-50% |
| Design Flexibility | Excellent | Excellent | Very Good | Excellent | Excellent | Good | Very Good |
| Finish Options | Very Good | Very Good | Excellent | Good | Fair | Good | Good |
| I/O Applications | Excellent | Fair | Fair | Very Good | Excellent | Fair | Fair |
| Shield Effectiveness | Excellent | Excellent | Excellent | Excellent | Very Good | Excellent | Excellent |
| Tooling/NRE | Low | None | None | None/Low | Low | None | Low |
| Part Cost | \$\$\$ | \$\$\$ | \$\$\$ | \$ | \$\$ | \$ | \$\$ |
| Lead Times | Very Good | Very Good | Excellent | Excellent | Very Good | Very Good | Good |

Notice:

Leader Tech cannot guarantee that the same test data as described herein will be obtained. Thus, it is recommended that each user make their own tests to confirm laboratory test data and determine suitability of products for their particular application.

The products described in this catalog shall be standard quality, however, the products in this catalog are sold without warranty of fitness for a particular purpose, either expressed or implied, except to the extent expressly stated on Leader Tech's quotation or order acknowledgment. Leader Tech does not warrant that devices incorporating one or more of the products described in this catalog will be free of conflict with existing or future patents of third parties. All risks of lack of fitness, patent infringement, and the like are assumed by the user. Furthermore, nothing contained herein shall be construed as recommendation to make, use, or sell any product or process in conflict with existing or future patents.

TABLE OF CONTENTS

| | | |
|-----------|--|---|
| 4 | Application of Fingerstock Gaskets | |
| 5 | Compression/Deflection Performance and EMI Shielding Effectiveness | |
| 6 | Ordering Information & Adhesive Mounting Instructions | |
| 7 | Metals Galvanic Compatibility Chart | |
| 8 | BeCu Low Profile Series |  |
| 8 | BeCu PCI Series |  |
| 9 | BeCu Adhesive Mount Series |  |
| 9 | BeCu Dome Top Series..... |  |
| 10 | BeCu Slot Mount Series |  |
| 12 | BeCu Folded Series |  |
| 14 | BeCu Twist Series |  |
| 16 | BeCu Clip-On Series..... |  |
| 18 | BeCu Grounding Series..... |  |
| 19 | BeCu Contact Series |  |
| 22 | Metal D-Subs |  |
| 23 | Precision Metal Stampings..... |  |
| 24 | TechSIL Conductive Elastomers |  |
| 25 | TechSIL Oriented Wire |  |
| 26 | TechMESH Knitted Wire..... |  |
| 27 | TechMESH Elastomer Core Wire |  |
| 28 | TechMESH Combo Strip..... |  |
| 29 | TechMESH Tape |  |
| 30 | FSG Fabric Shielding Gaskets |  |
| 35 | Shielding Fabrics & Conductive Tapes..... |  |
| 36 | CFS Conductive Foam Shielding Material |  |
| 37 | Custom and Die-Cut Shielding Gaskets..... |  |
| 39 | Products and Literature..... |  |

APPLICATION OF FINGERSTOCK GASKETS

EMI designers know and trust the consistent performance of Fingerstock (CuBe) gaskets. To date, CuBe yields the best electrical spring contact available in this industry. The copper beryllium mills have well established techniques and for decades have produced CuBe alloys per ASTM, SAE, JIS, and DIN specifications.

Leader Tech uses only proven technology in creating copper beryllium springs, contacts and gaskets. Beginning with Alloy 25 (1/4 hard) BeCu, we stamp, form, and post heat-treat to a hardness of 340 to 390 DPH. This process is preferred in the EMI shielding industry because it has proven to produce the best electrical spring contacts. Leader Tech CuBe EMI shielding gaskets are the most reliable in the industry.

Leader Tech manufactures a wide variety of standard styles and sizes of CuBe gaskets. These gaskets operate in spaces from .010 inches up to .410 inches. Using CuBe materials as thin as .002 inch, we also offer many styles as soft gaskets that provide the low compression force needed in many applications. Leader Tech also designs and manufactures custom spring contacts and gaskets.



FINGERSTOCK GASKETS DO TWO THINGS VERY WELL:

1. Their mechanical spring characteristics far surpass all other gaskets in the industry.
2. They offer the highest EMI shielding effectiveness.

Leader Tech has been designing and manufacturing Fingerstock Gaskets since the early days of the computer and electronics industries. We combine these years of manufacturing and EMI experience with one key ingredient – the needs of the customer.

Our innovative Fingerstock Gasket designs are a direct result of our experience and customer input. Our Compact PCI line of EMI Gaskets is an example of a design that was driven by the needs of a customer and evolved into a line of gaskets that meet all the requirements for Compact PCI faceplate standards while providing superior mechanical and shielding performance.

Leader Tech offers many standard off-the-shelf Fingerstock Gaskets as well as the engineering and custom manufacturing experience to help you solve your application. Whether you need one prototype or a large quantity order, our team at Leader Tech is available to respond to your needs.



COMPRESSION/DEFLECTION PERFORMANCE

| Leader Tech. Part No. | Design Compressed Height | Compression Force (lbs./linear ft.) |
|-----------------------|--------------------------|-------------------------------------|
| 3-23T | 0.018 (0.46) | 25 |
| 6-34T | 0.049 (1.24) | 33 |
| 6-50T2 | 0.049 (1.24) | 43 |
| 9-19UD | 0.072 (1.83) | 30 |
| 11-32RH | 0.035 (0.89) | 34 |
| 11-45C | 0.090 (2.29) | 19 |

| Leader Tech. Part No. | Design Compressed Height | Compression Force (lbs./linear ft.) |
|-----------------------|--------------------------|-------------------------------------|
| 14-45DT | 0.098 (2.49) | 24 |
| 22-60AH | 0.140 (3.56) | 25 |
| 22-60RH | 0.070 (1.78) | 48 |
| 23-76FSC | 0.130 (3.30) | 34 |
| 25-109C | 0.140 (3.56) | 36 |
| 25-78FS | 0.150 (3.81) | 36 |

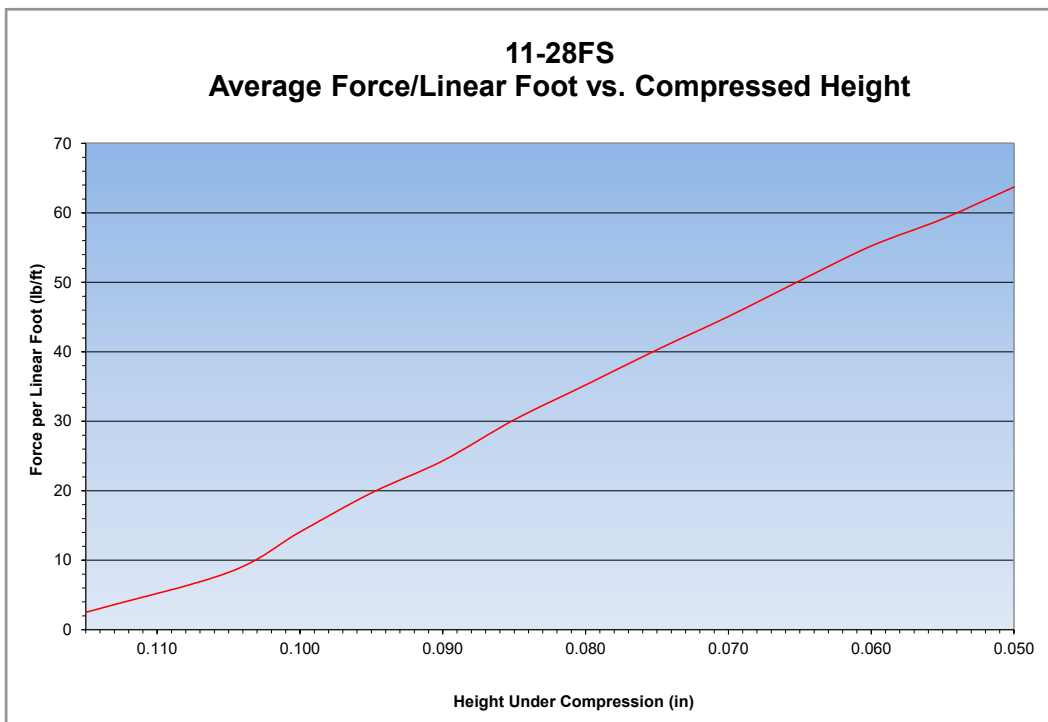

The data presented is based on testing and to our knowledge is accurate and true. Since applications, test methods, and test procedures may vary, we recommend that users of our products perform their own test to assure the suitability of these specific applications. We offer no product warranty, either expressed or implied, except that any product proven defective will be replaced. Freedom from present or future patent infringement cannot be guaranteed, nor can the suitability of our products for specific applications.

ORDERING INFORMATION

When placing an order or requesting a quotation, please give part number, your required finish I.D. from the chart below, and required length.

| PART NUMBER EXAMPLE: | | |
|----------------------|-------------|--------|
| Stock Item | Finish Code | Length |
| 11-S-32RH | - SN - | 16 |

The above example is the "Slot Mount Series" gasket shown on page 11. The height is .11 inch and the width is .32 inch. The "-S-" indicates a soft gasket. The "SN" indicates a bright tin finish. See list below for available finishes. This part is available in lengths of 16 inches. Consult factory for custom lengths or for availability in 25' coils.

| Available Plating Finishes: | | |
|-----------------------------|--|-------------------------|
| Finish Type | Applicable Specifications | Leader Tech Finish Code |
| Bright Finish | - | BD |
| Bright Tin | ASTM B-545, CLASS A | SN |
| Satin/Matte Tin | ASTM B-545, CLASS A | ST |
| Tin Lead | ASTM B-579, SC2 | SNpb |
| Electro-less Nickel RoHS | ASTM B-733, SC 1, CLASS 1 | NI |
| Zinc/Chromate Clear | ASTM B-633, SC1, TYPE III | Zinc |
| Zinc/Chromate Yellow | ASTM B-633, SC1, TYPE II | ZincY |
| Clear Cadmium Chromate | ASTM B-766, CLASS 5, TYPE III | CDC |
| Yellow Cadmium Chromate | ASTM B-766, CLASS 5, TYPE II | CDY |
| Bright Silver | ASTM B-700, TYPE 2, GRADE B, CLASS N | AG |
| Satin/Matte Silver | ASTM B-700, TYPE 2, GRADE A, CLASS N | MAG |
| Gold | ASTM B-488, TYPE I, CODE C, CLASS 1.25 | AU |
| Solderable Unplated | - | SU |

Standard plating finish is .0001 inch (.0025 mm) minimum. Plating processes and thicknesses may be varied to meet customer needs. Standard plating finish for gold is 0.00005 inches. See adjacent list of available finishes and consult factory for additional options.

ADHESIVE MOUNTING OF FINGERSTOCK GASKETS

Leader Tech tape mounted CuBe gaskets offer pressure-sensitive, double-sided adhesive for strong bonding to a wide variety of surface conditions. Ideal for all-purpose contact strips used in metal cabinets and electronic enclosures and is unaffected by temperatures from -67 to +250°F (-55 to 121°C)

Simply follow these four easy steps:

1. Remove all grease and oily residue with a solvent such as isopropyl alcohol/water mixture (rubbing alcohol) or heptane. Dry and smooth the mounting surface with emery cloth if necessary.
2. Peel off the protective paper backing from the pressure sensitive adhesive tape.
3. Place the gasket in correct position. Press firmly to ensure a good bond to surface. Avoid repositioning, which might impair the effectiveness of the adhesive or may bend or kink the strip. NOTE: On strips where fingers cover the solid portion of the gasket, pressure may be applied by inserting a mandrel in the strip and pressing down.
4. At room temperature approximately 50% of the ultimate strength will be achieved after 20 minutes, 90% after 24 hours, and 100% after 72 hours. In some cases, bond strength can be increased and ultimate bond strength can be achieved more quickly by exposure of the bond to elevated temperature, e.g., 150°F (66°C) for 1 hour.

METALS GALVANIC COMPATIBILITY CHART

| Group Number | Metallurgical Category | Anodic Index (V) | Compatible Surface Finishes | | | | | | |
|--------------|---|------------------|-----------------------------|--------|--------|-------|-------|-------|-------|
| | | | Gold | Silver | Nickel | Be-Cu | Tin | Sn-Pb | Zinc |
| 1 | Gold, solid and plated, Wrought platinum, graphite carbon | 0.00 | Harsh | Harsh | Harsh | Harsh | Harsh | Harsh | Harsh |
| 2 | | 0.05 | Harsh | Harsh | Harsh | Harsh | Harsh | Harsh | Harsh |
| 3 | Rhodium plating | 0.10 | Harsh | Harsh | Harsh | Harsh | Harsh | Harsh | Harsh |
| 4 | Silver, high-silver alloys | 0.15 | Harsh | Harsh | Harsh | Harsh | Harsh | Harsh | Harsh |
| 5 | | 0.20 | Harsh | Harsh | Harsh | Harsh | Harsh | Harsh | Harsh |
| 6 | | 0.25 | Harsh | Harsh | Harsh | Harsh | Harsh | Harsh | Harsh |
| 7 | Nickel, nickel-copper alloys, titanium, titanium alloys, Monel | 0.30 | Harsh | Harsh | Harsh | Harsh | Harsh | Harsh | Harsh |
| 8 | Beryllium Copper, low brasses or bronzes, silver solder, copper, Ni-Cr alloys, austenitic corrosion resistant steels, most chrome-moly steels, specialty high-temp stainless steels | 0.35 | Harsh | Harsh | Harsh | Harsh | Harsh | Harsh | Harsh |
| 9 | Commercial yellow brasses and bronzes | 0.40 | Harsh | Harsh | Harsh | Harsh | Harsh | Harsh | Harsh |
| 10 | High brasses and bronzes, naval brass, Muntz metal | 0.45 | Harsh | Harsh | Harsh | Harsh | Harsh | Harsh | Harsh |
| 11 | 18% Cr type corrosion resistant steels, common 300 series stainless steels | 0.50 | Harsh | Harsh | Harsh | Harsh | Harsh | Harsh | Harsh |
| 12 | | 0.55 | Harsh | Harsh | Harsh | Harsh | Harsh | Harsh | Harsh |
| 13 | Chromium or tin plating; 12% Cr type corrosion resistant steels, most 400 series stainless steels, i.e., 410 and some cast stainless steels | 0.60 | Harsh | Harsh | Harsh | Harsh | Harsh | Harsh | Harsh |
| 14 | Terreplate, tin-lead solder | 0.65 | Harsh | Harsh | Harsh | Harsh | Harsh | Harsh | Harsh |
| 15 | Lead; high-lead alloys | 0.70 | Harsh | Harsh | Harsh | Harsh | Harsh | Harsh | Harsh |
| 16 | Wrought 2000 series aluminum alloys | 0.75 | Harsh | Harsh | Harsh | Harsh | Harsh | Harsh | Harsh |
| 17 | | 0.80 | Harsh | Harsh | Harsh | Harsh | Harsh | Harsh | Harsh |
| 18 | Wrought aluminum alloys except 2000 series cast Al-Si alloys, 6000 series aluminum | 0.85 | Harsh | Harsh | Harsh | Harsh | Harsh | Harsh | Harsh |
| 19 | | 0.90 | Harsh | Harsh | Harsh | Harsh | Harsh | Harsh | Harsh |
| 20 | Cast aluminum alloys other than Al-Si; cadmium plating | 0.95 | Harsh | Harsh | Harsh | Harsh | Harsh | Harsh | Harsh |
| 21 | | 1.00 | Harsh | Harsh | Harsh | Harsh | Harsh | Harsh | Harsh |
| 22 | | 1.05 | Harsh | Harsh | Harsh | Harsh | Harsh | Harsh | Harsh |
| 23 | | 1.10 | Harsh | Harsh | Harsh | Harsh | Harsh | Harsh | Harsh |
| 24 | | 1.15 | Harsh | Harsh | Harsh | Harsh | Harsh | Harsh | Harsh |
| 25 | Hot Dipped galvanized or electrogalvanized steel | 1.20 | Harsh | Harsh | Harsh | Harsh | Harsh | Harsh | Harsh |
| 26 | Wrought zinc; zinc die cast alloys | 1.25 | Harsh | Harsh | Harsh | Harsh | Harsh | Harsh | Harsh |
| 27 | | 1.30 | Harsh | Harsh | Harsh | Harsh | Harsh | Harsh | Harsh |
| 28 | | 1.35 | Harsh | Harsh | Harsh | Harsh | Harsh | Harsh | Harsh |
| 29 | | 1.40 | Harsh | Harsh | Harsh | Harsh | Harsh | Harsh | Harsh |
| 30 | | 1.45 | Harsh | Harsh | Harsh | Harsh | Harsh | Harsh | Harsh |
| 31 | | 1.50 | Harsh | Harsh | Harsh | Harsh | Harsh | Harsh | Harsh |
| 32 | | 1.55 | Harsh | Harsh | Harsh | Harsh | Harsh | Harsh | Harsh |
| 33 | | 1.60 | Harsh | Harsh | Harsh | Harsh | Harsh | Harsh | Harsh |
| 34 | | 1.65 | Harsh | Harsh | Harsh | Harsh | Harsh | Harsh | Harsh |
| 35 | | 1.70 | Harsh | Harsh | Harsh | Harsh | Harsh | Harsh | Harsh |
| 36 | Wrought and cast magnesium alloys | 1.75 | Harsh | Harsh | Harsh | Harsh | Harsh | Harsh | Harsh |
| 37 | | 1.80 | Harsh | Harsh | Harsh | Harsh | Harsh | Harsh | Harsh |
| 38 | Beryllium | 1.85 | Harsh | Harsh | Harsh | Harsh | Harsh | Harsh | Harsh |

*Harsh Environment .10 volts Max ■ *Normal Environment .25 volts Max. ■ *Office Environment .50 volts Max ■

LOW PROFILE SERIES

| LPAH Low Profile Adhesive Mount | | | | | | | | | | | | | | Black = inches Blue = mm | |
|-----------------------------------|------|------|------|-------|--------|------|-------|------|------------|-------|--------|-----|---------|--------------------------|--|
| PART NUMBER | A | | B | | FINGER | | PITCH | | MAT. THICK | | LENGTH | | FINGERS | TAPE | |
| 8-45LPAH-XX-16 | 0.08 | 2.03 | 0.45 | 11.43 | 0.100 | 2.54 | 0.125 | 3.18 | 0.004 | 0.102 | 16 | 406 | 128 | 0.145 | |
| 8-S-45LPAH-XX-16 | 0.08 | 2.03 | 0.45 | 11.43 | 0.100 | 2.54 | 0.125 | 3.18 | 0.003 | 0.076 | 16 | 406 | 128 | 0.145 | |
| 12-60LPAH-XX-16 | 0.12 | 3.05 | 0.60 | 15.24 | 0.100 | 2.54 | 0.125 | 3.18 | 0.004 | 0.102 | 16 | 406 | 128 | 0.200 | |
| 12-S-60LPAH-XX-16 | 0.12 | 3.05 | 0.60 | 15.24 | 0.100 | 2.54 | 0.125 | 3.18 | 0.003 | 0.076 | 16 | 406 | 128 | 0.200 | |



MOUNTING
OPTIONS
Tape

The low profile series gaskets incorporate design features that allow for some of the lowest compression forces in the industry, while achieving high performance shielding effectiveness. These gaskets are ideally suited for small aperture applications.

XX - Select material/finish (see page 6)

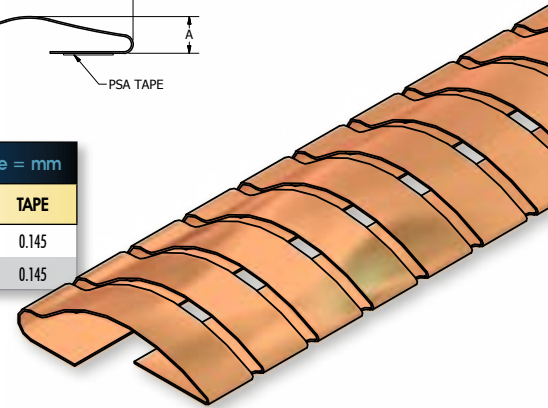
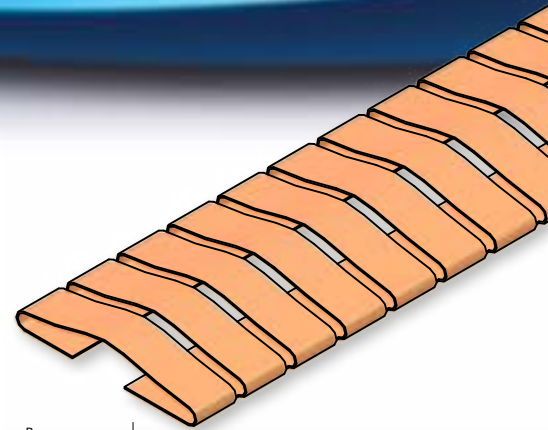

| LPH Low Profile Hook | | | | | | | | | | | | | | Black = inches Blue = mm | |
|------------------------|------|------|------|-------|--------|------|-------|------|------------|-------|--------|-----|---------|--------------------------|-------|
| PART NUMBER | A | | B | | FINGER | | PITCH | | MAT. THICK | | LENGTH | | HOOK ID | TAPE | |
| 6-45LPH-060-XX-16 | 0.06 | 1.52 | 0.45 | 11.43 | 0.100 | 2.54 | 0.125 | 3.18 | 0.004 | 0.102 | 16 | 406 | 128 | 0.060 | 0.145 |
| 6-S-45LPH-060-XX-16 | 0.06 | 1.52 | 0.45 | 11.43 | 0.100 | 2.54 | 0.125 | 3.18 | 0.003 | 0.076 | 16 | 406 | 128 | 0.060 | 0.145 |



MOUNTING
OPTIONS
Tape

XX - Select material/finish (see page 6)



PCI SERIES

High performance Compact PCI Gaskets designed for easy card insertion in rack mount applications. This gasket is available in two different sizes to accommodate different customer extrusions. They are available in both Copper Beryllium and Stainless Steel.

| PCI Contact | | | | | | | | | | | | | | | | Black = inches Blue = mm | |
|-----------------|------|------|------|------|------|------|------|------|--------|------|-------|------|------------|-------|--------|--------------------------|----|
| PART NUMBER | A | | B | | C | | D | | FINGER | | PITCH | | MAT. THICK | | LENGTH | FINGERS | |
| 7-19PCI-XX-4.6 | 0.07 | 1.78 | 0.18 | 4.57 | 0.05 | 1.27 | 0.01 | 0.25 | 0.180 | 4.57 | 0.200 | 5.08 | 0.002 | 0.051 | 4.60 | 117 | 23 |
| 7-19PCI-XX-9.0 | 0.07 | 1.78 | 0.18 | 4.57 | 0.05 | 1.27 | 0.01 | 0.25 | 0.180 | 4.57 | 0.200 | 5.08 | 0.002 | 0.051 | 9.00 | 229 | 45 |
| 7-19PCI-XX-14.4 | 0.07 | 1.78 | 0.18 | 4.57 | 0.05 | 1.27 | 0.01 | 0.25 | 0.180 | 4.57 | 0.200 | 5.08 | 0.002 | 0.051 | 14.40 | 366 | 72 |
| 7-19PCI-SS-4.6 | 0.07 | 1.78 | 0.18 | 4.57 | 0.05 | 1.27 | 0.01 | 0.25 | 0.180 | 4.57 | 0.200 | 5.08 | 0.002 | 0.051 | 4.60 | 117 | 23 |
| 7-19PCI-SS-9.0 | 0.07 | 1.78 | 0.18 | 4.57 | 0.05 | 1.27 | 0.01 | 0.25 | 0.180 | 4.57 | 0.200 | 5.08 | 0.002 | 0.051 | 9.00 | 229 | 45 |
| 7-19PCI-SS-14.4 | 0.07 | 1.78 | 0.18 | 4.57 | 0.05 | 1.27 | 0.01 | 0.25 | 0.180 | 4.57 | 0.200 | 5.08 | 0.002 | 0.051 | 14.40 | 366 | 72 |
| 8-19PCI-XX-4.6 | 0.07 | 1.78 | 0.19 | 4.83 | 0.05 | 1.27 | 0.02 | 0.51 | 0.180 | 4.57 | 0.200 | 5.08 | 0.002 | 0.051 | 4.60 | 117 | 23 |
| 8-19PCI-XX-9.0 | 0.07 | 1.78 | 0.19 | 4.83 | 0.05 | 1.27 | 0.02 | 0.51 | 0.180 | 4.57 | 0.200 | 5.08 | 0.002 | 0.051 | 9.00 | 229 | 45 |
| 8-19PCI-XX-14.4 | 0.07 | 1.78 | 0.19 | 4.83 | 0.05 | 1.27 | 0.02 | 0.51 | 0.180 | 4.57 | 0.200 | 5.08 | 0.002 | 0.051 | 14.40 | 366 | 72 |
| 8-19PCI-SS-4.6 | 0.07 | 1.78 | 0.19 | 4.83 | 0.05 | 1.27 | 0.02 | 0.51 | 0.180 | 4.57 | 0.200 | 5.08 | 0.002 | 0.051 | 4.60 | 117 | 23 |
| 8-19PCI-SS-9.0 | 0.07 | 1.78 | 0.19 | 4.83 | 0.05 | 1.27 | 0.02 | 0.51 | 0.180 | 4.57 | 0.200 | 5.08 | 0.002 | 0.051 | 9.00 | 229 | 45 |
| 8-19PCI-SS-14.4 | 0.07 | 1.78 | 0.19 | 4.83 | 0.05 | 1.27 | 0.02 | 0.51 | 0.180 | 4.57 | 0.200 | 5.08 | 0.002 | 0.051 | 14.40 | 366 | 72 |



MOUNTING
OPTIONS
Extrusion

XX - Select material/finish (see page 6)

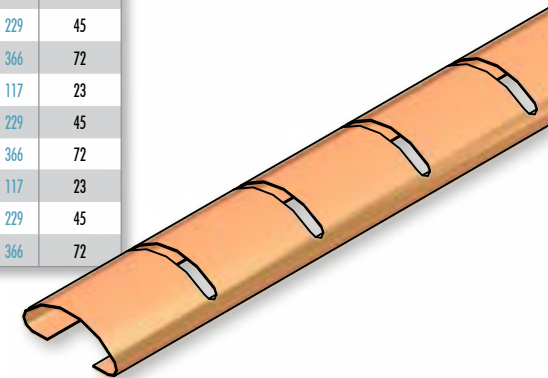

ADHESIVE MOUNT SERIES

| AH Adhesive Mount | | Black = inches Blue = mm Comp = Compressed | | | | | | | | | | | | | | | | | | |
|---------------------|------|--|------|-------|------|-------|--------|------|-------|------|------------|-------|------------|-------|-------------|------|--------|-----|---------|-------|
| PART NUMBER | A | | B | | C | | FINGER | | PITCH | | MAT. THICK | | COMP WIDTH | | COMP HEIGHT | | LENGTH | | FINGERS | TAPE |
| 11-32AH-XX-16 | 0.11 | 2.79 | 0.32 | 8.13 | 0.20 | 5.08 | 0.170 | 4.32 | 0.187 | 4.75 | 0.003 | 0.076 | 0.39 | 9.91 | 0.04 | 1.02 | 16 | 406 | 86 | 0.145 |
| 11-S-32AH-XX-16 | 0.11 | 2.79 | 0.32 | 8.13 | 0.20 | 5.08 | 0.170 | 4.32 | 0.187 | 4.75 | 0.002 | 0.051 | 0.39 | 9.91 | 0.04 | 1.02 | 16 | 406 | 86 | 0.145 |
| 13-37AH-XX-16 | 0.13 | 3.30 | 0.37 | 9.40 | 0.21 | 5.33 | 0.225 | 5.72 | 0.250 | 6.35 | 0.003 | 0.076 | 0.51 | 12.95 | 0.05 | 1.27 | 16 | 406 | 64 | 0.145 |
| 13-S-37AH-XX-16 | 0.13 | 3.30 | 0.37 | 9.40 | 0.21 | 5.33 | 0.225 | 5.72 | 0.250 | 6.35 | 0.002 | 0.051 | 0.51 | 12.95 | 0.05 | 1.27 | 16 | 406 | 64 | 0.145 |
| 14-38AH-XX-16 | 0.14 | 3.56 | 0.38 | 9.65 | 0.20 | 5.08 | 0.343 | 8.71 | 0.375 | 9.53 | 0.004 | 0.102 | 0.53 | 13.46 | 0.05 | 1.27 | 16 | 406 | 43 | 0.145 |
| 22-60AH-XX-16 | 0.22 | 5.59 | 0.60 | 15.24 | 0.28 | 7.11 | 0.344 | 8.74 | 0.375 | 9.53 | 0.005 | 0.127 | 0.73 | 18.54 | 0.09 | 2.29 | 16 | 406 | 43 | 0.200 |
| 22-S-60AH-XX-16 | 0.22 | 5.59 | 0.60 | 15.24 | 0.28 | 7.11 | 0.344 | 8.74 | 0.375 | 9.53 | 0.003 | 0.076 | 0.73 | 18.54 | 0.09 | 2.29 | 16 | 406 | 43 | 0.200 |
| 32-78AH-XX-16 | 0.32 | 8.13 | 0.78 | 19.81 | 0.45 | 11.43 | 0.344 | 8.74 | 0.375 | 9.53 | 0.004 | 0.102 | 0.98 | 24.89 | 0.12 | 3.05 | 16 | 406 | 43 | 0.375 |
| 32-S-78AH-XX-16 | 0.32 | 8.13 | 0.78 | 19.81 | 0.45 | 11.43 | 0.344 | 8.74 | 0.375 | 9.53 | 0.003 | 0.076 | 0.98 | 24.89 | 0.12 | 3.05 | 16 | 406 | 43 | 0.375 |



MOUNTING
OPTIONS
Tape

The AH Series gaskets are adhesive mounted general-purpose gaskets used in both compression and wiping applications. Sizes range from .11" (2.8mm) to .32" (8.1mm) in height. Applications include electronic enclosures, shielded cabinets, and MRI chamber doors.

XX - Select material/finish (see page 6)



DOMESTOP SERIES

The Dome Top Gaskets are known for their large surface area for electrical contact and smooth wiping action. Also available in a solid top profile allowing for omni-directional wiping. Together with the Slot Mount Series, the Dome Top Gaskets are a mainstay in the enclosure/chassis industries. Commonly mounted with adhesive tape.

| DT Dome Top | | Black = inches Blue = mm Comp = Compressed | | | | | | | | | | | | | | | | | | |
|-----------------|------|--|------|-------|--------|------|-------|------|------------|-------|------------|-------|-------------|------|--------|-----|---------|-------|--|--|
| PART NUMBER | A | | B | | FINGER | | PITCH | | MAT. THICK | | COMP WIDTH | | COMP HEIGHT | | LENGTH | | FINGERS | TAPE | | |
| 11-35DT-XX-15 | 0.11 | 2.79 | 0.35 | 8.89 | 0.169 | 4.29 | 0.187 | 4.75 | 0.003 | 0.076 | 0.38 | 9.65 | 0.06 | 1.52 | 15 | 381 | 80 | 0.100 | | |
| 11-S-35DT-XX-15 | 0.11 | 2.79 | 0.35 | 8.89 | 0.169 | 4.29 | 0.187 | 4.75 | 0.002 | 0.051 | 0.38 | 9.65 | 0.06 | 1.52 | 15 | 381 | 80 | 0.100 | | |
| 14-45DT-XX-15 | 0.14 | 3.56 | 0.45 | 11.43 | 0.228 | 5.79 | 0.250 | 6.35 | 0.003 | 0.076 | 0.51 | 12.95 | 0.07 | 1.78 | 15 | 381 | 60 | 0.100 | | |
| 14-S-45DT-XX-15 | 0.14 | 3.56 | 0.45 | 11.43 | 0.228 | 5.79 | 0.250 | 6.35 | 0.002 | 0.051 | 0.51 | 12.95 | 0.07 | 1.78 | 15 | 381 | 60 | 0.100 | | |
| 22-62DT-XX-15 | 0.22 | 5.59 | 0.62 | 15.75 | 0.345 | 8.76 | 0.375 | 9.53 | 0.004 | 0.102 | 0.76 | 19.30 | 0.10 | 2.54 | 15 | 381 | 40 | 0.200 | | |
| 22-S-62DT-XX-15 | 0.22 | 5.59 | 0.62 | 15.75 | 0.345 | 8.76 | 0.375 | 9.53 | 0.003 | 0.076 | 0.76 | 19.30 | 0.10 | 2.54 | 15 | 381 | 40 | 0.200 | | |



MOUNTING
OPTIONS
Tape

The Dome Top gaskets have fully independent fingers that are adhesive mounted. Their smooth curve provides a large area for electrical contact and smooth wiping action.

XX - Select material/finish (see page 6)



| DTS Dome Top Solid | | Black = inches Blue = mm Comp = Compressed | | | | | | | | | | | | | | | | | | |
|----------------------|------|--|------|-------|--------|------|-------|------|------------|-------|------------|-------|-------------|------|--------|-----|---------|-------|--|--|
| PART NUMBER | A | | B | | FINGER | | PITCH | | MAT. THICK | | COMP WIDTH | | COMP HEIGHT | | LENGTH | | FINGERS | TAPE | | |
| 11-35DTS-XX-15 | 0.11 | 2.79 | 0.35 | 8.89 | 0.169 | 4.29 | 0.187 | 4.75 | 0.003 | 0.076 | 0.38 | 9.65 | 0.06 | 1.52 | 15 | 381 | 80 | 0.100 | | |
| 11-S-35DTS-XX-15 | 0.11 | 2.79 | 0.35 | 8.89 | 0.169 | 4.29 | 0.187 | 4.75 | 0.002 | 0.051 | 0.38 | 9.65 | 0.06 | 1.52 | 15 | 381 | 80 | 0.100 | | |
| 14-45DTS-XX-15 | 0.14 | 3.56 | 0.45 | 11.43 | 0.250 | 6.35 | 0.250 | 6.35 | 0.003 | 0.076 | 0.51 | 12.95 | 0.07 | 1.78 | 15 | 381 | 60 | 0.100 | | |
| 14-S-45DTS-XX-15 | 0.14 | 3.56 | 0.45 | 11.43 | 0.250 | 6.35 | 0.250 | 6.35 | 0.002 | 0.051 | 0.51 | 12.95 | 0.07 | 1.78 | 15 | 381 | 60 | 0.100 | | |
| 22-62DTS-XX-15 | 0.22 | 5.59 | 0.62 | 15.75 | 0.345 | 8.76 | 0.375 | 9.53 | 0.004 | 0.102 | 0.76 | 19.30 | 0.10 | 2.54 | 15 | 381 | 40 | 0.200 | | |
| 22-S-62DTS-XX-15 | 0.22 | 5.59 | 0.62 | 15.75 | 0.345 | 8.76 | 0.375 | 9.53 | 0.003 | 0.076 | 0.76 | 19.30 | 0.10 | 2.54 | 15 | 381 | 40 | 0.200 | | |



MOUNTING
OPTIONS
Tape

The Dome Top "Solid" Series gaskets have a strip that connects each finger along the top. This allows for unique angular wiping action without snagging. Other features are the same as the Dome Top Series.

XX - Select material/finish (see page 6)



SLOT MOUNT SERIES

Slot mount gaskets are a standard in the electronic enclosure industry. These gaskets are used in shorter lengths as ESD contacts and longer lengths as EMI gaskets, which clip into slots or slide onto mounted tracks.

| AF Alternate Finger Slot Mount | | | | | | | | | | | | | | | Black = inches Blue = mm | | | | | | | | |
|----------------------------------|------|------|------|-------|------|------|------|------|-------------------|------|-------------------|-------|-------------------|------|--------------------------|-------|-------|------------|-------|--------|----|---------|----|
| PART NUMBER | A | | B | | C | | D | | *E Recommended | | *F Recommended | | *G Recommended | | FINGER | PITCH | | MAT. THICK | | LENGTH | | FINGERS | |
| 11-32AF-XX-16 | 0.11 | 2.79 | 0.32 | 8.13 | 0.08 | 2.03 | 0.02 | 0.51 | 0.09 | 2.29 | 0.26 | 6.60 | 0.04 | 1.02 | 0.169 | 4.29 | 0.187 | 4.75 | 0.004 | 0.102 | 16 | 406 | 85 |
| 11-32AF3-XX-16 | 0.11 | 2.79 | 0.32 | 8.13 | 0.08 | 2.03 | 0.02 | 0.51 | 0.09 | 2.29 | 0.26 | 6.60 | 0.04 | 1.02 | 0.169 | 4.29 | 0.187 | 4.75 | 0.004 | 0.102 | 16 | 406 | 85 |
| 11-32AF4-XX-16 | 0.11 | 2.79 | 0.32 | 8.13 | 0.08 | 2.03 | 0.02 | 0.51 | 0.09 | 2.29 | 0.26 | 6.60 | 0.04 | 1.02 | 0.169 | 4.29 | 0.187 | 4.75 | 0.004 | 0.102 | 16 | 406 | 85 |
| 11-S-32AF-XX-16 | 0.11 | 2.79 | 0.32 | 8.13 | 0.08 | 2.03 | 0.02 | 0.51 | 0.09 | 2.29 | 0.26 | 6.60 | 0.04 | 1.02 | 0.169 | 4.29 | 0.187 | 4.75 | 0.002 | 0.051 | 16 | 406 | 85 |
| 11-S-32AF3-XX-16 | 0.11 | 2.79 | 0.32 | 8.13 | 0.08 | 2.03 | 0.02 | 0.51 | 0.09 | 2.29 | 0.26 | 6.60 | 0.04 | 1.02 | 0.169 | 4.29 | 0.187 | 4.75 | 0.002 | 0.051 | 16 | 406 | 85 |
| 11-S-32AF4-XX-16 | 0.11 | 2.79 | 0.32 | 8.13 | 0.08 | 2.03 | 0.02 | 0.51 | 0.09 | 2.29 | 0.26 | 6.60 | 0.04 | 1.02 | 0.169 | 4.29 | 0.187 | 4.75 | 0.002 | 0.051 | 16 | 406 | 85 |
| 22-60AF-XX-16 | 0.22 | 5.59 | 0.60 | 15.24 | 0.14 | 3.56 | 0.04 | 1.02 | 0.14 | 3.56 | 0.52 | 13.21 | 0.07 | 1.78 | 0.250 | 6.35 | 0.282 | 7.16 | 0.005 | 0.127 | 16 | 406 | 57 |
| 22-60AF3-XX-16 | 0.22 | 5.59 | 0.60 | 15.24 | 0.14 | 3.56 | 0.04 | 1.02 | 0.14 | 3.56 | 0.52 | 13.21 | 0.07 | 1.78 | 0.250 | 6.35 | 0.282 | 7.16 | 0.005 | 0.127 | 16 | 406 | 58 |
| 22-S-60AF-XX-16 | 0.22 | 5.59 | 0.60 | 15.24 | 0.14 | 3.56 | 0.04 | 1.02 | 0.14 | 3.56 | 0.52 | 13.21 | 0.07 | 1.78 | 0.250 | 6.35 | 0.282 | 7.16 | 0.003 | 0.076 | 16 | 406 | 57 |
| 22-S-60AF3-XX-16 | 0.22 | 5.59 | 0.60 | 15.24 | 0.14 | 3.56 | 0.04 | 1.02 | 0.14 | 3.56 | 0.52 | 13.21 | 0.07 | 1.78 | 0.250 | 6.35 | 0.282 | 7.16 | 0.003 | 0.076 | 16 | 406 | 58 |



MOUNTING
OPTIONS
Slot

*May vary depending on application

XX - Select material/finish (see page 6)

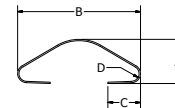

Alternate Finger Mounting Hole Recommendations



Variable Slot Mount Chart

A PATTERN PITCH FOR 11-32AF AND 11-S-32AF

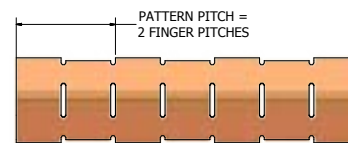

B PATTERN PITCH FOR 11-32AF3 AND 11-S-32AF3

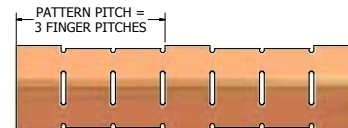

C PATTERN PITCH FOR 11-32AF4 AND 11-S-32AF4

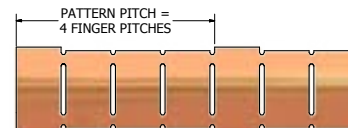

SLOT MOUNT SERIES CONT.

| RH Slot Mount | | | | | | | | | | | | | Black = inches Blue = mm | | | | | | | | | | |
|-----------------|------|------|------|-------|------|------|------|------|----------------------------------|------|----------------------------------|-------|----------------------------------|------|--------|-------|------------|------|--------|---------|----|-----|----|
| PART NUMBER | A | | B | | C | | D | | *N <small>Recommended</small> | | *O <small>Recommended</small> | | *P <small>Recommended</small> | | FINGER | PITCH | MAT. THICK | | LENGTH | FINGERS | | | |
| 11-28RH-XX-16 | 0.11 | 2.79 | 0.28 | 7.11 | 0.08 | 2.03 | 0.02 | 0.51 | 0.09 | 2.29 | 0.22 | 5.59 | 0.04 | 1.02 | 0.169 | 4.29 | 0.187 | 4.75 | 0.003 | 0.076 | 16 | 406 | 86 |
| 11-S-28RH-XX-16 | 0.11 | 2.79 | 0.28 | 7.11 | 0.08 | 2.03 | 0.02 | 0.51 | 0.09 | 2.29 | 0.22 | 5.59 | 0.04 | 1.02 | 0.169 | 4.29 | 0.187 | 4.75 | 0.002 | 0.054 | 16 | 406 | 86 |
| 11-32RH-XX-16 | 0.11 | 2.79 | 0.32 | 8.13 | 0.09 | 2.29 | 0.02 | 0.51 | 0.09 | 2.29 | 0.26 | 6.60 | 0.04 | 1.02 | 0.169 | 4.29 | 0.187 | 4.75 | 0.003 | 0.076 | 16 | 406 | 86 |
| 11-S-32RH-XX-16 | 0.11 | 2.79 | 0.32 | 8.13 | 0.09 | 2.29 | 0.02 | 0.51 | 0.09 | 2.29 | 0.26 | 6.60 | 0.04 | 1.02 | 0.169 | 4.29 | 0.187 | 4.75 | 0.002 | 0.054 | 16 | 406 | 86 |
| 13-30RH-XX-16 | 0.13 | 3.30 | 0.30 | 7.62 | 0.09 | 2.29 | 0.03 | 0.76 | 0.09 | 2.29 | 0.25 | 6.35 | 0.05 | 1.27 | 0.169 | 4.29 | 0.187 | 4.75 | 0.004 | 0.102 | 16 | 406 | 86 |
| 13-37RH-XX-16 | 0.13 | 3.30 | 0.37 | 9.40 | 0.09 | 2.29 | 0.02 | 0.51 | 0.09 | 2.29 | 0.31 | 7.87 | 0.04 | 1.02 | 0.225 | 5.72 | 0.250 | 6.35 | 0.003 | 0.076 | 16 | 406 | 64 |
| 13-S-37RH-XX-16 | 0.13 | 3.30 | 0.37 | 9.40 | 0.09 | 2.29 | 0.02 | 0.51 | 0.09 | 2.29 | 0.31 | 7.87 | 0.04 | 1.02 | 0.225 | 5.72 | 0.250 | 6.35 | 0.002 | 0.054 | 16 | 406 | 64 |
| 22-60RH-XX-16 | 0.22 | 5.59 | 0.60 | 15.24 | 0.14 | 3.56 | 0.04 | 1.02 | 0.14 | 3.56 | 0.52 | 13.21 | 0.06 | 1.52 | 0.250 | 6.23 | 0.282 | 7.16 | 0.005 | 0.127 | 16 | 406 | 57 |
| 22-S-60RH-XX-16 | 0.22 | 5.59 | 0.60 | 15.24 | 0.14 | 3.56 | 0.04 | 1.02 | 0.14 | 3.56 | 0.52 | 13.21 | 0.06 | 1.52 | 0.250 | 6.35 | 0.282 | 7.16 | 0.003 | 0.076 | 16 | 406 | 57 |



MOUNTING
OPTIONS

*May vary depending on application

XX - Select material/finish (see page 6)

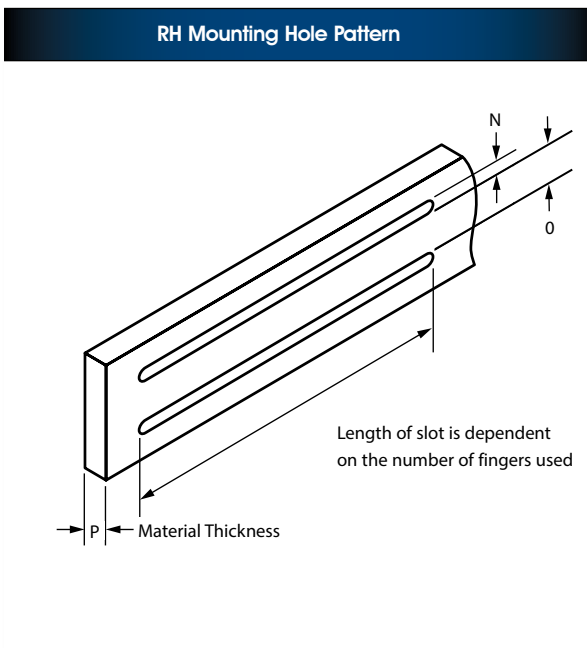

MOUNTING CONCEPTS

FOLDED SERIES

Leader Tech's Folded Gasket series are industry standard, general-purpose gaskets that allow a large range of deflection and compression forces. These gaskets are available with or without tape for alternate attachment methods. Also available in a snag-free version where, under compression, the leading edge of the gasket slides into an extended and folded base which prevents possible damage to the gasket.

| FS Folded | | Black = inches Blue = mm Comp = Compressed | | | | | | | | | | | | | | | | | | |
|------------------|------|--|------|-------|------|-------|--------|-------|-------|-------|------------|-------|-------------|-------|-------------|------|--------|------|---------|-------|
| PART NUMBER | A | | B | | C | | FINGER | | PITCH | | MAT. THICK | | COMP LENGTH | | COMP HEIGHT | | LENGTH | | FINGERS | TAPE |
| 11-28FS-XX-16 | 0.11 | 2.79 | 0.28 | 7.11 | 0.24 | 6.10 | 0.170 | 4.32 | 0.188 | 4.78 | 0.003 | 0.076 | 0.37 | 9.40 | 0.07 | 1.78 | 16 | 406 | 85 | 0.145 |
| 11-28FS-XX-300 | 0.11 | 2.79 | 0.28 | 7.11 | 0.24 | 6.10 | 0.170 | 4.32 | 0.188 | 4.78 | 0.003 | 0.076 | 0.37 | 9.40 | 0.07 | 1.78 | 300 | 7620 | 1596 | 0.145 |
| 11-S-28FS-XX-16 | 0.11 | 2.79 | 0.28 | 7.11 | 0.24 | 6.10 | 0.170 | 4.32 | 0.188 | 4.78 | 0.002 | 0.051 | 0.37 | 9.40 | 0.07 | 1.78 | 16 | 406 | 85 | 0.145 |
| 11-S-28FS-XX-300 | 0.11 | 2.79 | 0.28 | 7.11 | 0.24 | 6.10 | 0.170 | 4.32 | 0.188 | 4.78 | 0.002 | 0.051 | 0.37 | 9.40 | 0.07 | 1.78 | 300 | 7620 | 1596 | 0.145 |
| 14-37FS-XX-16 | 0.14 | 3.56 | 0.37 | 9.40 | 0.32 | 8.13 | 0.228 | 5.79 | 0.250 | 6.35 | 0.003 | 0.076 | 0.50 | 12.70 | 0.10 | 2.54 | 16 | 406 | 64 | 0.200 |
| 14-37FS-XX-300 | 0.14 | 3.56 | 0.37 | 9.40 | 0.32 | 8.13 | 0.228 | 5.79 | 0.250 | 6.35 | 0.003 | 0.076 | 0.50 | 12.70 | 0.10 | 2.54 | 300 | 7620 | 1200 | 0.200 |
| 14-S-37FS-XX-16 | 0.14 | 3.56 | 0.37 | 9.40 | 0.31 | 7.87 | 0.228 | 5.79 | 0.250 | 6.35 | 0.002 | 0.051 | 0.50 | 12.70 | 0.10 | 2.54 | 16 | 406 | 64 | 0.200 |
| 23-60FS-XX-24 | 0.23 | 5.84 | 0.60 | 15.24 | 0.50 | 12.70 | 0.343 | 8.71 | 0.375 | 9.53 | 0.004 | 0.102 | 0.77 | 19.56 | 0.12 | 3.05 | 24 | 610 | 64 | 0.250 |
| 23-60FS-XX-300 | 0.23 | 5.84 | 0.60 | 15.24 | 0.50 | 12.70 | 0.343 | 8.71 | 0.375 | 9.53 | 0.004 | 0.102 | 0.77 | 19.56 | 0.12 | 3.05 | 300 | 7620 | 800 | 0.250 |
| 25-78FS-XX-24 | 0.25 | 6.35 | 0.78 | 19.81 | 0.53 | 13.46 | 0.335 | 8.51 | 0.375 | 9.53 | 0.005 | 0.127 | 0.94 | 23.88 | 0.15 | 3.81 | 24 | 610 | 64 | 0.375 |
| 25-78FS-XX-300 | 0.25 | 6.35 | 0.78 | 19.81 | 0.53 | 13.46 | 0.340 | 8.64 | 0.375 | 9.53 | 0.005 | 0.127 | 0.94 | 23.88 | 0.15 | 3.81 | 300 | 7620 | 800 | 0.375 |
| 25-S-78FS-XX-24 | 0.25 | 6.35 | 0.78 | 19.81 | 0.53 | 13.46 | 0.335 | 8.51 | 0.375 | 9.53 | 0.003 | 0.076 | 0.94 | 23.88 | 0.15 | 3.81 | 24 | 610 | 64 | 0.375 |
| 25-S-78FS-XX-300 | 0.25 | 6.35 | 0.78 | 19.81 | 0.53 | 13.46 | 0.335 | 8.51 | 0.375 | 9.53 | 0.003 | 0.076 | 0.94 | 23.88 | 0.15 | 3.81 | 300 | 7620 | 800 | 0.375 |
| 41-113FS-XX-12 | 0.41 | 10.41 | 1.13 | 28.70 | 0.80 | 20.32 | 0.460 | 11.68 | 0.500 | 12.70 | 0.007 | 0.178 | 1.94 | 49.28 | 0.23 | 5.84 | 12 | 305 | 24 | 0.375 |



MOUNTING OPTIONS
Tape
Solder
Rivet

The Leader Tech FS gaskets are industry standard, general-purpose gaskets that allow a large range of deflection and compression forces. These gaskets are available without tape for alternate attachment methods. Consult factory for information.

XX - Select material/finish (see page 6)



| FSC Folded | | Black = inches Blue = mm Comp = Compressed | | | | | | | | | | | | | | | |
|------------------|------|--|------|-------|--------|------|-------|------|------------|-------|-------------|------|--------|-----|---------|-------|------|
| PART NUMBER | A | | B | | FINGER | | PITCH | | MAT. THICK | | COMP HEIGHT | | LENGTH | | FINGERS | | TAPE |
| 8-25FSC-XX-16 | 0.08 | 2.03 | 0.25 | 6.35 | 0.170 | 4.32 | 0.188 | 4.78 | 0.003 | 0.076 | 0.048 | 1.22 | 16 | 406 | 85 | 0.145 | |
| 14-51FSC-XX-16 | 0.14 | 3.56 | 0.51 | 12.95 | 0.228 | 5.79 | 0.250 | 6.35 | 0.003 | 0.076 | 0.100 | 2.54 | 16 | 406 | 64 | 0.375 | |
| 14-S-51FSC-XX-16 | 0.14 | 3.56 | 0.51 | 12.95 | 0.228 | 5.79 | 0.250 | 6.35 | 0.002 | 0.051 | 0.100 | 2.54 | 16 | 406 | 64 | 0.375 | |
| 23-76FSC-XX-24 | 0.23 | 5.84 | 0.76 | 19.30 | 0.343 | 8.64 | 0.375 | 9.53 | 0.004 | 0.102 | 0.115 | 2.92 | 24 | 610 | 64 | 0.375 | |



MOUNTING OPTIONS
Tape
Solder
Rivet

The FSC was created to provide snag-free gaskets with FS gasket features. The base of the gasket is extended from the mounting area and then folded up, over, down, and then comes to rest over the leading edge of the formed spring. Under compression, the leading edge of the gasket slides under and is "captured." This "no snag" feature is also used to prevent possible gasket damage.

XX - Select material/finish (see page 6)



FOLDED SERIES CONT.

| FSV Folded | | Black = inches Blue = mm Comp = Compressed | | | | | | | | | | | | | | | | | | | | | |
|--------------------|------|--|------|-------|------|--------|------|-------|-------|------------|-------|------------|-------|-------------|-------|--------|------|---------|------|------|----|-----|----|
| PART NUMBER | A | B | C | D | E | FINGER | | PITCH | | MAT. THICK | | COMP WIDTH | | COMP HEIGHT | | LENGTH | | FINGERS | | | | | |
| 11-28FSV23-XX-16 | 0.11 | 2.79 | 0.28 | 7.11 | 0.24 | 6.10 | 0.06 | 1.52 | 0.188 | 4.78 | 0.170 | 4.32 | 0.188 | 4.78 | 0.003 | 0.076 | 0.37 | 9.40 | 0.07 | 1.78 | 16 | 406 | 85 |
| 11-S-28FSV23-XX-16 | 0.11 | 2.79 | 0.28 | 7.11 | 0.24 | 6.10 | 0.06 | 1.52 | 0.188 | 4.78 | 0.170 | 4.32 | 0.188 | 4.78 | 0.002 | 0.051 | 0.37 | 9.40 | 0.07 | 1.78 | 16 | 406 | 85 |
| 14-37FSV30-XX-16 | 0.14 | 3.66 | 0.37 | 9.40 | 0.32 | 8.13 | 0.06 | 1.52 | 0.250 | 6.35 | 0.228 | 5.79 | 0.250 | 6.35 | 0.003 | 0.076 | 0.50 | 12.70 | 0.10 | 2.54 | 16 | 406 | 64 |
| 14-S-37FSV30-XX-16 | 0.14 | 3.66 | 0.37 | 9.40 | 0.32 | 8.13 | 0.06 | 1.52 | 0.250 | 6.35 | 0.228 | 5.79 | 0.250 | 6.35 | 0.002 | 0.051 | 0.50 | 12.70 | 0.10 | 2.54 | 16 | 406 | 64 |
| 23-60FSV50-XX-24 | 0.23 | 5.84 | 0.60 | 15.24 | 0.50 | 12.70 | 0.08 | 2.03 | 0.375 | 9.53 | 0.343 | 8.71 | 0.375 | 9.50 | 0.004 | 0.102 | 0.77 | 19.56 | 0.12 | 3.05 | 24 | 610 | 64 |
| 25-78FSV50-XX-24 | 0.25 | 6.35 | 0.78 | 19.81 | 0.50 | 12.70 | 0.14 | 3.56 | 0.375 | 9.53 | 0.335 | 8.51 | 0.375 | 9.50 | 0.005 | 0.127 | 0.94 | 23.88 | 0.15 | 3.81 | 24 | 610 | 64 |
| 25-S-78FSV50-XX-24 | 0.25 | 6.35 | 0.78 | 19.81 | 0.50 | 12.70 | 0.14 | 3.56 | 0.375 | 9.53 | 0.335 | 8.51 | 0.375 | 9.50 | 0.003 | 0.076 | 0.94 | 23.88 | 0.15 | 3.81 | 24 | 610 | 64 |
| 41-113FSV-XX-12 | 0.41 | 10.41 | 1.13 | 28.70 | 0.80 | 20.32 | 0.14 | 3.56 | 0.500 | 12.70 | 0.460 | 11.68 | 0.500 | 12.70 | 0.007 | 0.178 | 1.94 | 49.28 | 0.23 | 5.84 | 12 | 305 | 24 |



MOUNTING OPTIONS
Tape
Rivet
Solder

The FSV is an FS gasket that has the base bent at a right angle to the curve of the spring form, with all the other features of the FS gasket maintained. Tape optional - please consult factory.

XX - Select material/finish (see page 6)

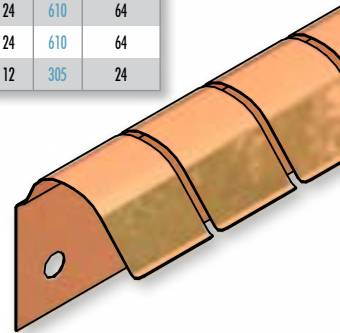

| FSDS Folded | | Black = inches Blue = mm Comp = Compressed | | | | | | | | | | | | | | | | | | | | | |
|---------------------|------|--|------|-------|------|--------|------|-------|------|------------|-------|-------------|-------|----------------|------|--------|------|---------|-------|-------|-----|------|-----|
| PART NUMBER | A | B | C | D | E | FINGER | | PITCH | | COMP WIDTH | | COMP HEIGHT | | MATERIAL THICK | | LENGTH | | FINGERS | | | | | |
| 25-109FSDS-XX-24 | 0.25 | 6.35 | 1.09 | 27.69 | 0.16 | 4.06 | 0.14 | 3.56 | 0.38 | 9.65 | 0.335 | 8.51 | 0.375 | 9.53 | 1.27 | 32.26 | 0.15 | 3.81 | 0.005 | 0.127 | 24 | 610 | 64 |
| 25-109FSDS-XX-300 | 0.25 | 6.35 | 1.09 | 27.69 | 0.16 | 4.06 | 0.14 | 3.56 | 0.38 | 9.65 | 0.335 | 8.51 | 0.375 | 9.53 | 1.27 | 32.26 | 0.15 | 3.81 | 0.005 | 0.127 | 300 | 7620 | 800 |
| 25-S-109FSDS-XX-24 | 0.25 | 6.35 | 1.09 | 27.69 | 0.16 | 4.06 | 0.14 | 3.56 | 0.38 | 9.65 | 0.335 | 8.51 | 0.375 | 9.53 | 1.27 | 32.26 | 0.15 | 3.81 | 0.003 | 0.076 | 24 | 610 | 64 |
| 25-S-109FSDS-XX-300 | 0.25 | 6.35 | 1.09 | 27.69 | 0.16 | 4.06 | 0.14 | 3.56 | 0.38 | 9.65 | 0.335 | 8.51 | 0.375 | 9.53 | 1.27 | 32.26 | 0.15 | 3.81 | 0.003 | 0.076 | 300 | 7620 | 800 |
| 41-163FSDS-XX-24 | 0.41 | 10.41 | 1.63 | 41.40 | 0.19 | 4.83 | 0.14 | 3.56 | 0.50 | 12.70 | 0.460 | 11.68 | 0.500 | 12.70 | 1.90 | 48.26 | 0.23 | 5.84 | 0.007 | 0.178 | 24 | 610 | 48 |
| 41-163FSDS-XX-300 | 0.41 | 10.41 | 1.63 | 41.40 | 0.19 | 4.83 | 0.14 | 3.56 | 0.50 | 12.70 | 0.460 | 11.68 | 0.500 | 12.70 | 1.90 | 48.26 | 0.23 | 5.84 | 0.007 | 0.178 | 300 | 7620 | 600 |



MOUNTING OPTIONS
Tape
Rivet
Solder

The FSDS is an FS gasket with its base lying on the same plane as the curve in the spring form, with the mounting area shortened. This mounting is often modified for custom applications.

XX - Select material/finish (see page 6)

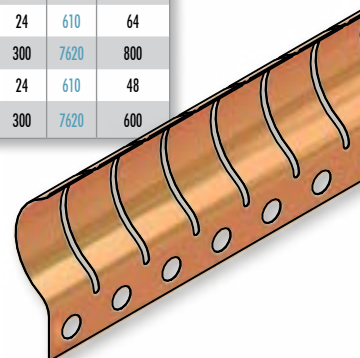
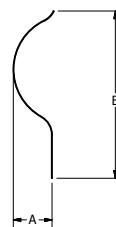
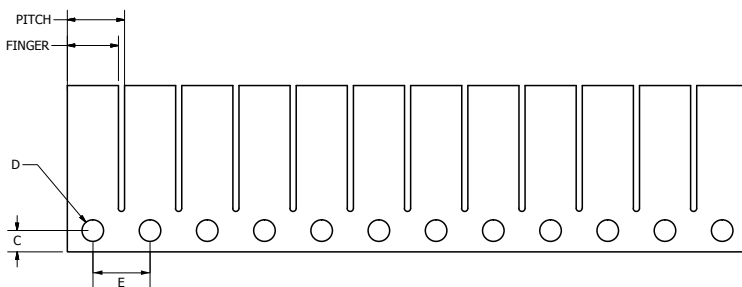

TWIST SERIES

The Twist series gaskets are designed for demanding compression applications. This series can compress to material thickness and provide excellent shielding performance. Profiles include standard flat, right angle, double twist, and clip-on.

| T Twist | | Black = inches Blue = mm Comp = Compressed | | | | | | | | | | | | | | |
|----------------|------|--|------|------|------|------|--------|------|-------|------|----------------|-------|--------|------|---------|-------|
| PART NUMBER | A | | B | | C | | FINGER | | PITCH | | MATERIAL THICK | | LENGTH | | FINGERS | TAPE |
| 3-20T-XX-24 | 0.03 | 0.76 | 0.20 | 5.08 | 0.11 | 2.79 | 0.080 | 2.03 | 0.095 | 2.41 | 0.003 | 0.076 | 24 | 610 | 253 | 0.100 |
| 3-20T-XX-300 | 0.03 | 0.76 | 0.20 | 5.08 | 0.11 | 2.79 | 0.080 | 2.03 | 0.095 | 2.41 | 0.003 | 0.076 | 300 | 7620 | 3158 | 0.100 |
| 3-23T-XX-24 | 0.03 | 0.76 | 0.23 | 5.84 | 0.14 | 3.56 | 0.080 | 2.03 | 0.095 | 2.41 | 0.003 | 0.076 | 24 | 610 | 253 | 0.100 |
| 3-23T-XX-300 | 0.03 | 0.76 | 0.23 | 5.84 | 0.14 | 3.56 | 0.080 | 2.03 | 0.095 | 2.41 | 0.003 | 0.076 | 300 | 7620 | 3158 | 0.100 |
| 3-S-23T-XX-24 | 0.03 | 0.76 | 0.23 | 5.84 | 0.14 | 3.56 | 0.080 | 2.03 | 0.095 | 2.41 | 0.002 | 0.051 | 24 | 610 | 253 | 0.100 |
| 3-S-23T-XX-300 | 0.03 | 0.76 | 0.23 | 5.84 | 0.14 | 3.56 | 0.080 | 2.03 | 0.095 | 2.41 | 0.002 | 0.051 | 300 | 7620 | 3158 | 0.100 |
| 6-30T-XX-24 | 0.07 | 1.78 | 0.30 | 7.62 | 0.15 | 3.81 | 0.150 | 3.81 | 0.165 | 4.19 | 0.003 | 0.076 | 24 | 610 | 146 | 0.100 |
| 6-30T-XX-300 | 0.07 | 1.78 | 0.30 | 7.62 | 0.15 | 3.81 | 0.150 | 3.81 | 0.165 | 4.19 | 0.003 | 0.076 | 300 | 7620 | 1818 | 0.100 |
| 6-S-30T-XX-24 | 0.07 | 1.78 | 0.30 | 7.62 | 0.15 | 3.81 | 0.150 | 3.81 | 0.165 | 4.19 | 0.002 | 0.051 | 24 | 610 | 146 | 0.145 |
| 6-S-30T-XX-300 | 0.07 | 1.78 | 0.30 | 7.62 | 0.15 | 3.81 | 0.150 | 3.81 | 0.165 | 4.19 | 0.002 | 0.051 | 300 | 7620 | 1818 | 0.145 |
| 6-34T-XX-24 | 0.07 | 1.78 | 0.34 | 8.64 | 0.18 | 4.57 | 0.150 | 3.81 | 0.165 | 4.19 | 0.003 | 0.076 | 24 | 610 | 146 | 0.145 |
| 6-34T-XX-300 | 0.07 | 1.78 | 0.34 | 8.64 | 0.18 | 4.57 | 0.150 | 3.81 | 0.165 | 4.19 | 0.003 | 0.076 | 300 | 7620 | 1818 | 0.145 |
| 6-S-34T-XX-24 | 0.07 | 1.78 | 0.34 | 8.64 | 0.18 | 4.57 | 0.150 | 3.81 | 0.165 | 4.19 | 0.002 | 0.051 | 24 | 610 | 146 | 0.145 |
| 6-S-34T-XX-300 | 0.07 | 1.78 | 0.34 | 8.64 | 0.18 | 4.57 | 0.150 | 3.81 | 0.165 | 4.19 | 0.002 | 0.051 | 300 | 7620 | 1818 | 0.145 |



MOUNTING OPTIONS
Tape
Solder

XX - Select material/finish (see page 6)



| TV Twist | | Black = inches Blue = mm | | | | | | | | | | | | | | |
|-------------------|------|--------------------------|------|------|------|------|--------|------|-------|------|----------------|-------|--------|------|---------|-------|
| PART NUMBER | A | | B | | C | | FINGER | | PITCH | | MATERIAL THICK | | LENGTH | | FINGERS | TAPE |
| 3-23TV-XX-24 | 0.03 | 0.76 | 0.08 | 2.03 | 0.16 | 4.06 | 0.080 | 2.03 | 0.095 | 2.41 | 0.003 | 0.076 | 24 | 610 | 253 | 0.100 |
| 3-23TV-XX-30 | 0.03 | 0.76 | 0.08 | 2.03 | 0.16 | 4.06 | 0.080 | 2.03 | 0.095 | 2.41 | 0.003 | 0.076 | 300 | 7620 | 3158 | 0.100 |
| 3-23TV30-XX-24 | 0.03 | 0.76 | 0.08 | 2.03 | 0.30 | 7.62 | 0.080 | 2.03 | 0.095 | 2.41 | 0.003 | 0.076 | 24 | 610 | 253 | 0.250 |
| 3-S-23TV-XX-24 | 0.03 | 0.76 | 0.08 | 2.03 | 0.16 | 4.06 | 0.080 | 2.03 | 0.095 | 2.41 | 0.002 | 0.051 | 24 | 610 | 253 | 0.100 |
| 3-S-23TV30-XX-300 | 0.03 | 0.76 | 0.08 | 2.03 | 0.30 | 7.62 | 0.080 | 2.03 | 0.095 | 2.41 | 0.002 | 0.051 | 300 | 7620 | 3158 | 0.250 |
| 6-34TV-XX-24 | 0.07 | 1.78 | 0.14 | 3.56 | 0.20 | 5.08 | 0.150 | 3.81 | 0.165 | 4.19 | 0.003 | 0.076 | 24 | 610 | 146 | 0.145 |
| 6-34TV-XX-300 | 0.07 | 1.78 | 0.14 | 3.56 | 0.20 | 5.08 | 0.150 | 3.81 | 0.165 | 4.19 | 0.003 | 0.076 | 300 | 7620 | 1818 | 0.145 |
| 6-S-34TV-XX-24 | 0.07 | 1.78 | 0.14 | 3.56 | 0.20 | 5.08 | 0.150 | 3.81 | 0.165 | 4.19 | 0.002 | 0.051 | 24 | 610 | 146 | 0.145 |
| 6-S-34TV-XX-300 | 0.07 | 1.78 | 0.14 | 3.56 | 0.20 | 5.08 | 0.150 | 3.81 | 0.165 | 4.19 | 0.002 | 0.051 | 300 | 7620 | 1818 | 0.145 |



MOUNTING OPTIONS
Tape
Solder

XX - Select material/finish (see page 6)



TWIST SERIES CONT.

| T2 Twist | | Black = inches Blue = mm | | | | | | | | | | | | | | |
|-----------------|------|--------------------------|------|-------|------|------|--------|------|-------|------|----------------|-------|--------|------|---------|-------|
| PART NUMBER | A | | B | | C | | FINGER | | PITCH | | MATERIAL THICK | | LENGTH | | FINGERS | TAPE |
| 6-50T2-XX-24 | 0.07 | 1.78 | 0.50 | 12.70 | 0.18 | 4.57 | 0.150 | 3.81 | 0.165 | 4.19 | 0.003 | 0.076 | 24 | 610 | 146 | 0.145 |
| 6-50T2-XX-300 | 0.07 | 1.78 | 0.50 | 12.70 | 0.18 | 4.57 | 0.150 | 3.81 | 0.165 | 4.19 | 0.003 | 0.076 | 300 | 7620 | 1818 | 0.145 |
| 6-S-50T2-XX-24 | 0.07 | 1.78 | 0.50 | 12.70 | 0.18 | 4.57 | 0.150 | 3.81 | 0.165 | 4.19 | 0.002 | 0.051 | 24 | 610 | 146 | 0.145 |
| 6-S-50T2-XX-300 | 0.07 | 1.78 | 0.50 | 12.70 | 0.18 | 4.57 | 0.150 | 3.81 | 0.165 | 4.19 | 0.002 | 0.051 | 300 | 7620 | 1818 | 0.145 |



MOUNTING OPTIONS
Tape

XX - Select material/finish (see page 6)



| UT Twist | | Black = inches Blue = mm | | | | | | | | | | | | | | | |
|---------------------|------|--------------------------|------|------|--------|------|-------|------|----------------|-------|--------|-----|---------|---------|-------|-------------|-----|
| PART NUMBER | A | | B | | FINGER | | PITCH | | MATERIAL THICK | | LENGTH | | FINGERS | CLIP ID | LANCE | LANCE PITCH | |
| 3-23UT-040-XX-16 | 0.03 | 0.76 | 0.15 | 3.81 | 0.080 | 2.03 | 0.095 | 2.41 | 0.003 | 0.076 | 16 | 406 | 168 | 0.04 | 1.02 | n/a | n/a |
| 3-23UT-070-XX-16 | 0.03 | 0.76 | 0.15 | 3.81 | 0.080 | 2.03 | 0.095 | 2.41 | 0.003 | 0.076 | 16 | 406 | 168 | 0.07 | 1.78 | n/a | n/a |
| 3-23UT-070-DL-XX-16 | 0.03 | 0.76 | 0.15 | 3.81 | 0.080 | 2.03 | 0.095 | 2.41 | 0.003 | 0.076 | 16 | 406 | 168 | 0.07 | 1.78 | D | 1" |
| 6-34UT-040-XX-16 | 0.07 | 1.78 | 0.22 | 5.59 | 0.150 | 3.81 | 0.165 | 4.19 | 0.003 | 0.076 | 16 | 406 | 97 | 0.04 | 1.02 | n/a | n/a |
| 6-34UT-070-XX-16 | 0.07 | 1.78 | 0.22 | 5.59 | 0.150 | 3.81 | 0.165 | 4.19 | 0.003 | 0.076 | 16 | 406 | 97 | 0.07 | 1.78 | n/a | n/a |
| 6-34UT-070-DL-XX-16 | 0.07 | 1.78 | 0.22 | 5.59 | 0.150 | 3.81 | 0.165 | 4.19 | 0.003 | 0.076 | 16 | 406 | 97 | 0.07 | 1.78 | D | 1" |



MOUNTING OPTIONS
Clip

XX - Select material/finish (see page 6)



| UT3 Twist | | Black = inches Blue = mm | | | | | | | | | | | | | | | | | |
|----------------------|------|--------------------------|------|------|------|------|--------|------|-------|------|----------------|-------|--------|-----|---------|---------|-------|-------------|-----|
| PART NUMBER | A | | B | | C | | FINGER | | PITCH | | MATERIAL THICK | | LENGTH | | FINGERS | CLIP ID | LANCE | LANCE PITCH | |
| 6-34UT3-050-XX-16 | 0.07 | 1.78 | 0.38 | 9.65 | 0.22 | 5.59 | 0.150 | 3.81 | 0.165 | 4.19 | 0.003 | 0.076 | 16 | 406 | 97 | 0.05 | 1.27 | n/a | n/a |
| 6-34UT3-050-DL-XX-16 | 0.07 | 1.78 | 0.38 | 9.65 | 0.22 | 5.59 | 0.150 | 3.81 | 0.165 | 4.19 | 0.003 | 0.076 | 16 | 406 | 97 | 0.05 | 1.27 | D | 1" |
| 6-34UT3-070-XX-16 | 0.07 | 1.78 | 0.38 | 9.65 | 0.22 | 5.59 | 0.150 | 3.81 | 0.165 | 4.19 | 0.003 | 0.076 | 16 | 406 | 97 | 0.07 | 1.78 | n/a | n/a |
| 6-34UT3-070-DL-XX-16 | 0.07 | 1.78 | 0.38 | 9.65 | 0.22 | 5.59 | 0.150 | 3.81 | 0.165 | 4.19 | 0.003 | 0.076 | 16 | 406 | 97 | 0.07 | 1.78 | D | 1" |



MOUNTING OPTIONS
Clip

XX - Select material/finish (see page 6)

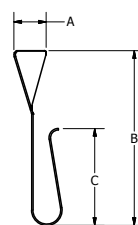

CLIP-ON SERIES

The Clip-On Gaskets are used in enclosures, shielded cabinets, and on circuit cards as ESD contacts and EMI gaskets. For edge mount applications, close attention must be given to clip size, lance requirements, deflection parameters and finger configuration. Leader Tech provides application assistance in the development of specifications.

| C Clip-On | | Black = inches Blue = mm Comp = Compressed | | | | | | | | | | | | | | | | | | | | |
|---------------|------|--|------|-------|------|------|--------|------|-------|------|----------------|-------|------------|-------|-------------|------|-------------|-------|-------------|-------|---------|-------|
| PART NUMBER | A | | B | | C | | FINGER | | PITCH | | MATERIAL THICK | | COMP WIDTH | | COMP HEIGHT | | LANCE START | | LANCE PITCH | | FINGERS | LANCE |
| 10-30CD-XX-16 | 0.10 | 2.54 | 0.30 | 7.62 | 0.07 | 1.78 | 0.135 | 3.43 | 0.182 | 4.62 | 0.005 | 0.127 | 0.33 | 8.38 | 0.05 | 1.27 | 0.341 | 8.66 | 0.728 | 18.49 | 88 | D |
| 10-30CT-XX-16 | 0.10 | 2.54 | 0.30 | 7.62 | 0.07 | 1.78 | 0.135 | 3.43 | 0.182 | 4.62 | 0.005 | 0.127 | 0.33 | 8.38 | 0.05 | 1.27 | 0.341 | 8.66 | 0.728 | 18.49 | 88 | T |
| 11-45CD-XX-16 | 0.11 | 2.79 | 0.45 | 11.43 | 0.07 | 1.78 | 0.147 | 3.73 | 0.193 | 4.90 | 0.005 | 0.127 | 0.47 | 11.94 | 0.06 | 1.52 | 0.267 | 6.78 | 0.748 | 19.00 | 84 | D |
| 11-45CT-XX-16 | 0.11 | 2.79 | 0.45 | 11.43 | 0.07 | 1.78 | 0.147 | 3.73 | 0.193 | 4.90 | 0.005 | 0.127 | 0.47 | 11.94 | 0.06 | 1.52 | 0.651 | 16.54 | 1.352 | 34.34 | 84 | T |



Clip XX - Select material/finish (see page 6)

10-30CD

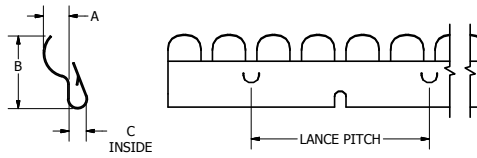
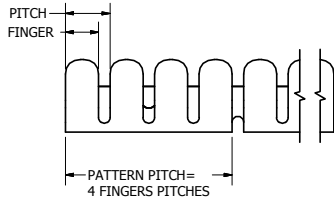

10-30CT

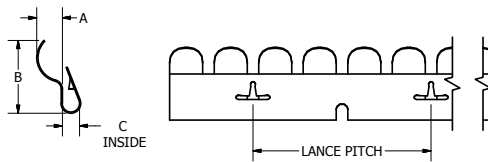
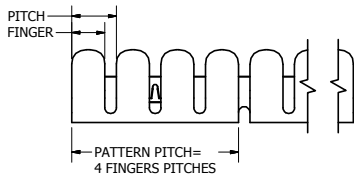

11-45CD

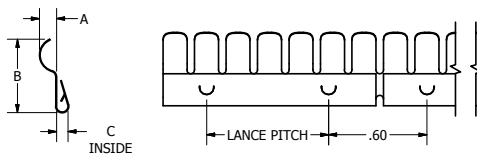
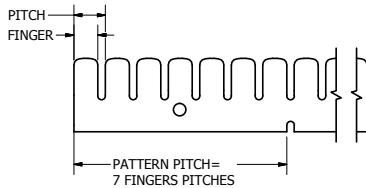

11-45CT

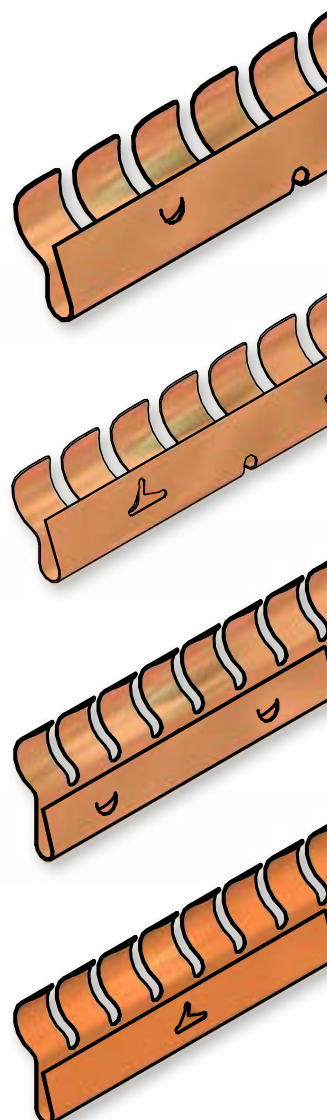
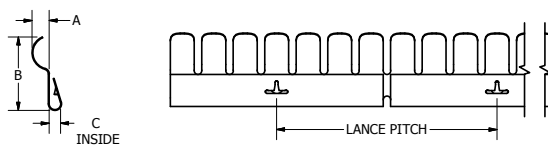
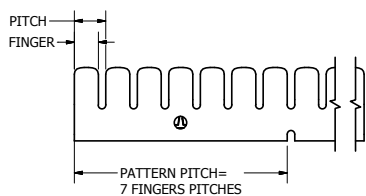

CLIP-ON SERIES CONT.

| C Mini-Clip | | | | | | | | | | | | | | | | | | | Black = inches Blue = mm | | |
|--------------------|------|------|------|------|------|------|--------|------|-------|------|----------------|-------|-------------|-------|-------------|-------|--------|---------|--------------------------|-------|---|
| PART NUMBER | A | | B | | C | | FINGER | | PITCH | | MATERIAL THICK | | LANCE START | | LANCE PITCH | | LENGTH | FINGERS | CLIP ID | LANCE | |
| 7-21C-045-DL-XX-16 | 0.07 | 1.78 | 0.25 | 6.35 | 0.03 | 0.76 | 0.170 | 4.32 | 0.200 | 5.08 | 0.003 | 0.076 | 0.49 | 12.45 | 1.00 | 25.40 | 16 | 406 | 80 | 0.045 | D |



Clip XX - Select material/finish (see page 6)



| C Clip-On | | | | | | | | | | | | | | | | | | | Black = inches Blue = mm Comp = Compressed | | | |
|------------------------|------|------|------|-------|-------|------|--------|------|-------|------|----------------|-------|------------|-------------|-------------|-------------|---------|-------|--|------|----|-----|
| PART NUMBER | A | | B | | C | | FINGER | | PITCH | | MATERIAL THICK | | COMP WIDTH | COMP HEIGHT | LANCE START | LANCE PITCH | FINGERS | LANCE | | | | |
| 10-30C-045-XX-16 | 0.10 | 2.54 | 0.30 | 7.62 | 0.045 | 1.14 | 0.140 | 3.56 | 0.187 | 4.75 | 0.005 | 0.127 | 0.33 | 8.38 | 0.05 | 1.27 | - | - | - | - | 86 | n/a |
| 10-30C-050-XX-16 | 0.10 | 2.54 | 0.30 | 7.62 | 0.050 | 1.27 | 0.140 | 3.56 | 0.187 | 4.75 | 0.005 | 0.127 | 0.33 | 8.38 | 0.05 | 1.27 | - | - | - | - | 86 | n/a |
| 10-30C-065-XX-16 | 0.10 | 2.54 | 0.30 | 7.62 | 0.065 | 1.65 | 0.140 | 3.56 | 0.187 | 4.75 | 0.005 | 0.127 | 0.33 | 8.38 | 0.05 | 1.27 | - | - | - | - | 86 | n/a |
| 10-30C-070-XX-16 | 0.10 | 2.54 | 0.30 | 7.62 | 0.070 | 1.78 | 0.140 | 3.56 | 0.187 | 4.75 | 0.005 | 0.127 | 0.33 | 8.38 | 0.05 | 1.27 | - | - | - | - | 86 | n/a |
| 10-30C-045-DL-XX-16 | 0.10 | 2.54 | 0.30 | 7.62 | 0.045 | 1.14 | 0.140 | 3.56 | 0.187 | 4.75 | 0.005 | 0.127 | 0.33 | 8.38 | 0.05 | 1.27 | 0.5 | 12.7 | 1 | 25.4 | 86 | D |
| 10-30C-050-DL-XX-16 | 0.10 | 2.54 | 0.30 | 7.62 | 0.050 | 1.27 | 0.140 | 3.56 | 0.187 | 4.75 | 0.005 | 0.127 | 0.33 | 8.38 | 0.05 | 1.27 | 0.5 | 12.7 | 1 | 25.4 | 86 | D |
| 10-30C-065-DL-XX-16 | 0.10 | 2.54 | 0.30 | 7.62 | 0.065 | 1.65 | 0.140 | 3.56 | 0.187 | 4.75 | 0.005 | 0.127 | 0.33 | 8.38 | 0.05 | 1.27 | 0.5 | 12.7 | 1 | 25.4 | 86 | D |
| 10-30C-070-DL-XX-16 | 0.10 | 2.54 | 0.30 | 7.62 | 0.070 | 1.78 | 0.140 | 3.56 | 0.187 | 4.75 | 0.005 | 0.127 | 0.33 | 8.38 | 0.05 | 1.27 | 0.5 | 12.7 | 1 | 25.4 | 86 | D |
| 11-45C-045-XX-16 | 0.11 | 2.79 | 0.45 | 11.43 | 0.045 | 1.14 | 0.140 | 3.56 | 0.187 | 4.75 | 0.005 | 0.127 | 0.47 | 11.94 | 0.06 | 1.52 | - | - | - | - | 86 | n/a |
| 11-45C-050-XX-16 | 0.11 | 2.79 | 0.45 | 11.43 | 0.050 | 1.27 | 0.140 | 3.56 | 0.187 | 4.75 | 0.005 | 0.127 | 0.47 | 11.94 | 0.06 | 1.52 | - | - | - | - | 86 | n/a |
| 11-45C-065-XX-16 | 0.11 | 2.79 | 0.45 | 11.43 | 0.065 | 1.65 | 0.140 | 3.56 | 0.187 | 4.75 | 0.005 | 0.127 | 0.47 | 11.94 | 0.06 | 1.52 | - | - | - | - | 86 | n/a |
| 11-45C-070-XX-16 | 0.11 | 2.79 | 0.45 | 11.43 | 0.070 | 1.78 | 0.140 | 3.56 | 0.187 | 4.75 | 0.005 | 0.127 | 0.47 | 11.94 | 0.06 | 1.52 | - | - | - | - | 86 | n/a |
| 11-45C-045-DL-XX-16 | 0.11 | 2.79 | 0.45 | 11.43 | 0.045 | 1.14 | 0.140 | 3.56 | 0.187 | 4.75 | 0.005 | 0.127 | 0.47 | 11.94 | 0.06 | 1.52 | 0.5 | 12.7 | 1 | 25.4 | 86 | D |
| 11-45C-050-DL-XX-16 | 0.11 | 2.79 | 0.45 | 11.43 | 0.050 | 1.27 | 0.140 | 3.56 | 0.187 | 4.75 | 0.005 | 0.127 | 0.47 | 11.94 | 0.06 | 1.52 | 0.5 | 12.7 | 1 | 25.4 | 86 | D |
| 11-45C-065-DL-XX-16 | 0.11 | 2.79 | 0.45 | 11.43 | 0.065 | 1.65 | 0.140 | 3.56 | 0.187 | 4.75 | 0.005 | 0.127 | 0.47 | 11.94 | 0.06 | 1.52 | 0.5 | 12.7 | 1 | 25.4 | 86 | D |
| 11-45C-070-DL-XX-16 | 0.11 | 2.79 | 0.45 | 11.43 | 0.070 | 1.78 | 0.140 | 3.56 | 0.187 | 4.75 | 0.005 | 0.127 | 0.47 | 11.94 | 0.06 | 1.52 | 0.5 | 12.7 | 1 | 25.4 | 86 | D |
| 25-109C-070-XX-16 | 0.25 | 6.35 | 1.09 | 27.69 | 0.070 | 1.78 | 0.340 | 8.64 | 0.375 | 9.53 | 0.005 | 0.127 | 1.27 | 32.26 | 0.08 | 2.03 | - | - | - | - | 43 | n/a |
| 25-109C-070-DL-XX-16 | 0.25 | 6.35 | 1.09 | 27.69 | 0.070 | 1.78 | 0.340 | 8.64 | 0.375 | 9.53 | 0.005 | 0.127 | 1.27 | 32.26 | 0.08 | 2.03 | 0.5 | 12.7 | 1 | 25.4 | 43 | D |
| 25-S-109C-070-XX-16 | 0.25 | 6.35 | 1.09 | 27.69 | 0.070 | 1.78 | 0.340 | 8.64 | 0.375 | 9.53 | 0.003 | 0.076 | 1.27 | 32.26 | 0.08 | 2.03 | - | - | - | - | 43 | n/a |
| 25-S-109C-070-DL-XX-16 | 0.25 | 6.35 | 1.09 | 27.69 | 0.070 | 1.78 | 0.340 | 8.64 | 0.375 | 9.53 | 0.003 | 0.076 | 1.27 | 32.26 | 0.08 | 2.03 | 0.5 | 12.7 | 1 | 25.4 | 43 | D |
| 25-109C-120-XX-16 | 0.25 | 6.35 | 1.09 | 27.69 | 0.120 | 3.05 | 0.340 | 8.64 | 0.375 | 9.53 | 0.005 | 0.127 | 1.27 | 32.26 | 0.08 | 2.03 | - | - | - | - | 43 | n/a |
| 25-109C-130-XX-16 | 0.25 | 6.35 | 1.09 | 27.69 | 0.130 | 3.30 | 0.340 | 8.64 | 0.375 | 9.53 | 0.005 | 0.127 | 1.27 | 32.26 | 0.08 | 2.03 | - | - | - | - | 43 | n/a |

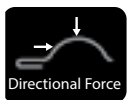

Clip Consult factory for optional clip sizes and optional lance features.

XX - Select material/finish (see page 6)



CLIP-ON SERIES CONT.

| CPS Clip-On | | Black = inches Blue = mm | | | | | | | | | | | | | | |
|----------------|------|--------------------------|------|-------|------|------|--------|------|-------|------|----------------|-------|--------|-----|---------------|-------|
| PART NUMBER | A | | B | | C | | FINGER | | PITCH | | MATERIAL THICK | | LENGTH | | FINGERS/STRIP | LANCE |
| 25-55CPS-XX-16 | 0.25 | 6.35 | 0.55 | 13.97 | 0.04 | 1.02 | 0.220 | 5.59 | 0.250 | 6.35 | 0.004 | 0.102 | 16 | 406 | 64 | D |

XX - Select material/finish (see page 6)

Perpendicular Shielding Gaskets

- Finger design allows for continuous contact across the length of the strip
- "D" lance provides superior retention of gasket to the mounting surface
- 0.80 D-clip is retained with .100 D-hole



| CPG Clip-On | | Black = inches Blue = mm | | | | | | | | | | | | | | |
|---------------|------|--------------------------|------|------|------|------|--------|-------|-------|-------|----------------|-------|--------|-----|---------------|-------|
| PART NUMBER | A | | B | | C | | FINGER | | PITCH | | MATERIAL THICK | | LENGTH | | FINGERS/STRIP | LANCE |
| 6-31CPG-XX-12 | 0.06 | 1.52 | 0.31 | 7.87 | 0.04 | 1.02 | 0.500 | 12.70 | 0.545 | 13.84 | 0.004 | 0.102 | 12 | 305 | 22 | D |
| 6-31CPG-XX-16 | 0.06 | 1.52 | 0.31 | 7.87 | 0.04 | 1.02 | 0.500 | 12.70 | 0.545 | 13.84 | 0.004 | 0.102 | 16 | 406 | 29 | D |

XX - Select material/finish (see page 6)

Perpendicular Electrical Grounding Strips

- Finger extension provides grounding from card or PCB to a backplane housing surface
- Wide clip-on area with "D" lance offers reliable retention
- .0035 material offers significant resiliency



GROUNDING SERIES

| ML Gasket | | Black = inches Blue = mm | | | | | | | | | | | | | |
|---------------|------|--------------------------|------|------|------|------|--------|------|-------|-------|----------------|-------|--------|--|---------|
| PART NUMBER | A | | B | | C | | FINGER | | PITCH | | MATERIAL THICK | | LENGTH | | FINGERS |
| 14-18ML-XX-16 | 0.14 | 3.56 | 0.28 | 7.11 | 0.18 | 4.57 | 0.080 | 2.03 | 0.500 | 12.70 | 0.005 | 0.127 | 32 | | |
| 14-18ML-XX-24 | 0.14 | 3.56 | 0.28 | 7.11 | 0.18 | 4.57 | 0.080 | 2.03 | 0.500 | 12.70 | 0.005 | 0.127 | 48 | | |

XX - Select material/finish (see page 6)

MOUNTING OPTIONS

Tape

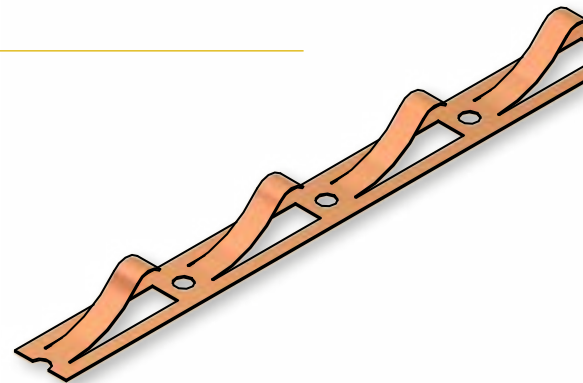

CONTACT SERIES

Contact gaskets are primarily used for grounding and shielding in high frequency applications. These gaskets provide engineers and designers with flexibility to solve their shielding and grounding issues. They are available in a variety of different lengths, widths and profiles. Standard factory length for Contact Series strips is 16". Individual contacts available in tape & reel packaging. Adhesive tape is optional - please consult factory.

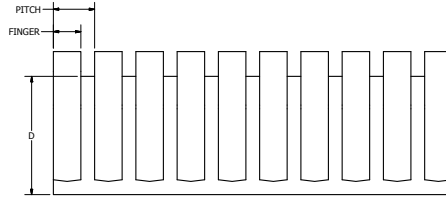

| 9-19UD 10-26UD 16-44UD Contact Series | | | Black = inches Blue = mm | | | | | | | | | | | | | | | |
|---|------|------|--------------------------|-------|------|------|------|------|--------|------|-------|------|------------|-------|--------|-----|---------------|------|
| PART NUMBER | A | | B | | C | | D | | FINGER | | PITCH | | MAT. THICK | | LENGTH | | FINGERS/STRIP | TAPE |
| 9-19UD-XX-16 | 0.09 | 2.29 | 0.19 | 4.83 | 0.11 | 2.79 | 0.13 | 3.30 | 0.040 | 1.02 | 0.060 | 1.52 | 0.004 | 0.102 | 16 | 406 | 266 | NO |
| 10-26UD-XX-16 | 0.11 | 2.79 | 0.26 | 6.60 | 0.17 | 4.32 | 0.22 | 5.59 | 0.050 | 1.27 | 0.075 | 1.90 | 0.006 | 0.152 | 16 | 406 | 213 | NO |
| 16-44UD-XX-16 | 0.16 | 4.06 | 0.44 | 11.18 | 0.24 | 6.10 | 0.33 | 8.38 | 0.062 | 1.57 | 0.093 | 2.36 | 0.010 | 0.254 | 16 | 406 | 172 | NO |

XX - Select material/finish (see page 6)



| 4-34D 4-38D 4-53D 9-78D 9-78D-A Contact Series | | | Black = inches Blue = mm | | | | | | | | | | | | | | | |
|--|------|------|--------------------------|-------|------|-------|-------|-------|--------|------|-------|------|----------------|-------|--------|-----|---------------|------|
| PART NUMBER | A | | B | | C | | D | | FINGER | | PITCH | | MATERIAL THICK | | LENGTH | | FINGERS/STRIP | TAPE |
| 4-34D-XX-16 | 0.04 | 1.02 | 0.34 | 8.63 | 0.29 | 7.37 | 0.13 | 3.30 | 0.040 | 1.02 | 0.060 | 1.52 | 0.004 | 0.102 | 16 | 406 | 266 | NO |
| 4-38D-XX-16 | 0.05 | 1.27 | 0.38 | 9.65 | 0.31 | 7.87 | 0.062 | 15.75 | 0.050 | 1.27 | 0.075 | 1.90 | 0.006 | 0.152 | 16 | 406 | 213 | NO |
| 4-53D-XX-16 | 0.05 | 1.27 | 0.53 | 13.46 | 0.47 | 11.94 | 0.22 | 5.59 | 0.050 | 1.27 | 0.075 | 1.90 | 0.006 | 0.152 | 16 | 406 | 213 | NO |
| 9-78D-XX-16 | 0.05 | 1.27 | 0.78 | 19.81 | 0.66 | 16.76 | 0.31 | 7.87 | 0.062 | 1.57 | 0.093 | 2.36 | 0.010 | 0.254 | 16 | 406 | 172 | NO |
| 9-78D-A-XX-16 | 0.09 | 2.29 | 0.78 | 19.81 | 0.66 | 16.76 | 0.31 | 7.87 | 0.062 | 1.57 | 0.093 | 2.36 | 0.010 | 0.254 | 16 | 406 | 172 | NO |

XX - Select material/finish (see page 6)



CONTACT SERIES CONT.



13-28U*



28-49U



| 7-13U 13-28U 28-49U Contact Series | | | | | | | | | | Black = inches Blue = mm | | | | | | | | |
|--------------------------------------|------|------|------|-------|------|------|------|------|--------|--------------------------|-------|------|------------|-------|--------|-----|---------------|------|
| PART NUMBER | A | | B | | C | | D | | FINGER | | PITCH | | MAT. THICK | | LENGTH | | FINGERS/STRIP | TAPE |
| 7-13U-XX-16 | 0.07 | 1.78 | 0.13 | 3.30 | 0.07 | 1.78 | 0.09 | 2.29 | 0.040 | 1.02 | 0.060 | 1.52 | 0.004 | 0.102 | 16 | 406 | 266 | NO |
| 13-28U-XX-16 | 0.13 | 3.30 | 0.28 | 7.11 | 0.16 | 4.06 | 0.23 | 5.84 | 0.095 | 2.41 | 0.135 | 3.43 | 0.010 | 0.254 | 16 | 406 | 118 | NO |
| 28-49U-XX-16 | 0.28 | 7.11 | 0.49 | 12.45 | 0.34 | 8.64 | 0.38 | 9.65 | 0.125 | 3.17 | 0.187 | 4.75 | 0.006 | 0.152 | 16 | 406 | 85 | NO |

XX - Select material/finish (see page 6)
 *Finger width starts at .095 and tapers to .092.

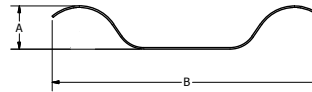
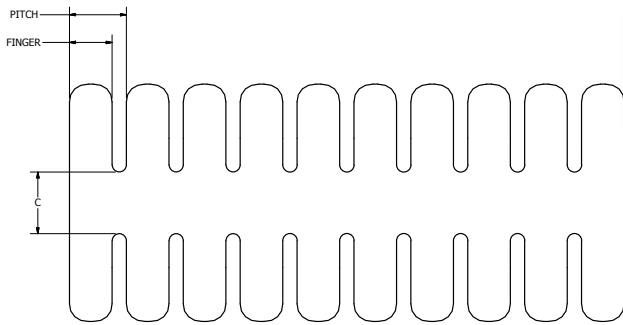

| 11-78R2 Contact Series | | | | | | | | | | Black = inches Blue = mm | | | | | | | |
|--------------------------|------|------|------|-------|------|------|--------|------|-------|--------------------------|------------|-------|--------|-----|---------------|------|--|
| PART NUMBER | A | | B | | C | | FINGER | | PITCH | | MAT. THICK | | LENGTH | | FINGERS/STRIP | TAPE | |
| 11-78R2-XX-16 | 0.13 | 3.30 | 0.78 | 19.81 | 0.20 | 5.08 | 0.140 | 3.56 | 0.187 | 4.75 | 0.005 | 0.127 | 16 | 406 | 86 | NO | |

XX - Select material/finish (see page 6)



| 11-90S Contact Series | | | | | | | | | | Black = inches Blue = mm | | | | | | | |
|-------------------------|------|------|------|-------|------|-------|------|------|--------|--------------------------|-------|------|------------|-------|--------|-----|---------------|
| PART NUMBER | A | | B | | C | | D | | FINGER | | PITCH | | MAT. THICK | | LENGTH | | FINGERS/STRIP |
| 11-90S-XX-16 | 0.11 | 2.79 | 0.90 | 22.86 | 0.66 | 16.76 | 0.38 | 9.65 | 0.125 | 3.17 | 0.172 | 4.37 | 0.010 | 0.254 | 16 | 406 | 93 |

XX - Select material/finish (see page 6)

CONTACT SERIES CONT.

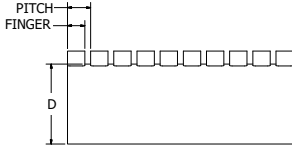

12-75RS | Contact Series Black = inches Blue = mm

| PART NUMBER | A | | B | | C | | D | | FINGER | | PITCH | | MAT. THICK | | LENGTH | FINGERS/STRIP | TAPE | |
|---------------|------|------|------|-------|------|------|------|-------|--------|------|-------|------|------------|-------|--------|---------------|------|-----|
| 12-75RS-XX-16 | 0.12 | 3.05 | 0.75 | 19.05 | 0.12 | 3.05 | 0.65 | 16.51 | 0.140 | 3.56 | 0.187 | 4.75 | 0.005 | 0.127 | 16 | 406 | 85 | YES |

XX - Select material/finish (see page 6)

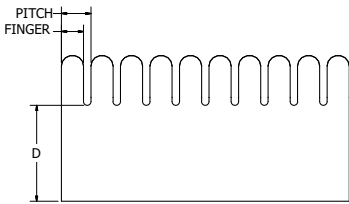
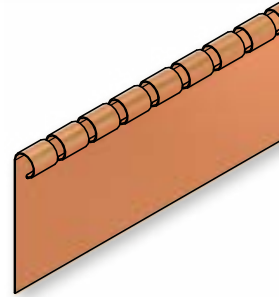
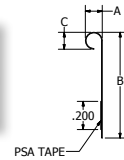

8-92RB | Contact Series Black = inches Blue = mm

| PART NUMBER | A | | B | | C | | D | | FINGER | | PITCH | | MAT. THICK | | LENGTH | FINGERS/STRIP | TAPE | |
|--------------|------|------|------|-------|------|------|------|-------|--------|------|-------|------|------------|-------|--------|---------------|------|----|
| 8-92RB-XX-16 | 0.09 | 2.29 | 0.92 | 23.37 | 0.30 | 7.62 | 0.61 | 15.49 | 0.140 | 3.56 | 0.187 | 4.75 | 0.005 | 0.127 | 16 | 406 | 85 | NO |

XX - Select material/finish (see page 6)

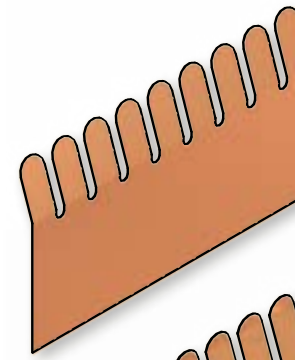
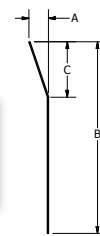

8-92RC | Contact Series Black = inches Blue = mm

| PART NUMBER | A | | B | | C | | D | | FINGER | | PITCH | | MAT. THICK | | LENGTH | FINGERS/STRIP | TAPE | |
|--------------|------|------|------|-------|------|------|------|-------|--------|------|-------|------|------------|-------|--------|---------------|------|----|
| 8-92RC-XX-16 | 0.09 | 2.29 | 0.92 | 23.37 | 0.30 | 7.62 | 0.63 | 16.00 | 0.140 | 3.56 | 0.187 | 4.75 | 0.005 | 0.127 | 16 | 406 | 85 | NO |

XX - Select material/finish (see page 6)

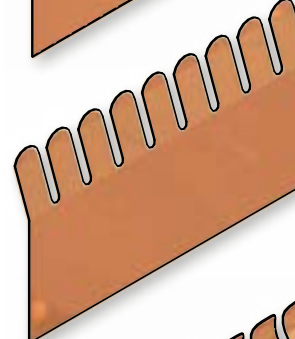
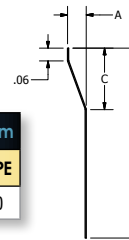

11-89RA | Contact Series Black = inches Blue = mm

| PART NUMBER | A | | B | | C | | D | | FINGER | | PITCH | | MAT. THICK | | LENGTH | FINGERS/STRIP | TAPE | |
|---------------|------|------|------|-------|------|-------|------|-------|--------|------|-------|------|------------|-------|--------|---------------|------|----|
| 11-89RA-XX-16 | 0.13 | 3.30 | 0.89 | 22.61 | 0.81 | 20.57 | 0.60 | 15.24 | 0.140 | 3.56 | 0.187 | 4.75 | 0.005 | 0.127 | 16 | 406 | 85 | NO |

XX - Select material/finish (see page 6)

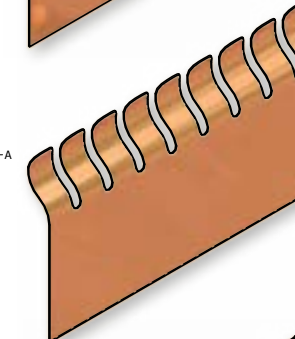
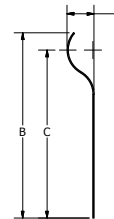

22-77RR | Contact Series Black = inches Blue = mm

| PART NUMBER | A | | B | | C | | D | | FINGER | | PITCH | | MAT. THICK | | LENGTH | FINGERS/STRIP | TAPE | |
|---------------|------|------|------|-------|------|-------|------|-------|--------|------|-------|------|------------|-------|--------|---------------|------|----|
| 22-77RR-XX-16 | 0.23 | 5.84 | 0.77 | 19.56 | 0.64 | 16.26 | 0.62 | 15.75 | 0.140 | 3.56 | 0.187 | 4.75 | 0.005 | 0.127 | 16 | 406 | 85 | NO |

XX - Select material/finish (see page 6)

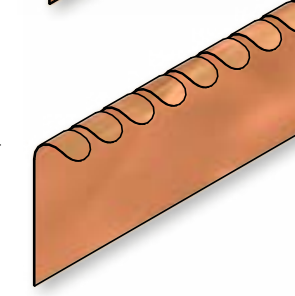
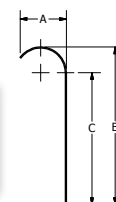

METAL D-SUBS



| Standard Finish and Plating Options | | |
|-------------------------------------|-----------------|-------------------------|
| FINISH TYPE | SPECIFICATIONS | LEADER TECH FINISH CODE |
| BRIGHT FINISH | As Heat Treated | BD (Standard) |
| BRIGHT TIN | ASTM B-545 | SN |
| SATIN TIN/MATTE TIN | ASTM B-545 | ST |
| ELECTROLESS BRIGHT NICKEL ROHS | ASTM B 733 | NI |

| D-Sub Miniature - Solid | | Black = inches Blue = mm | | | | | | | | | | | | | | | |
|-------------------------|--------|--------------------------|-------|------|-------|------|-------|------|-------|------|------|------|-------|-------|------|------|------|
| PART NUMBER | TYPE | A | B | C | D | E | F | G | H | | | | | | | | |
| 09D-110-XX | 9 Pin | 1.41 | 35.81 | 0.98 | 24.89 | 0.78 | 19.81 | 0.44 | 11.18 | 0.22 | 5.59 | 0.69 | 17.53 | 0.025 | 0.63 | 0.13 | 3.30 |
| 09D-100-SS | 9 Pin | 1.41 | 35.81 | 0.98 | 24.89 | 0.78 | 19.81 | 0.44 | 11.18 | 0.22 | 5.59 | 0.69 | 17.53 | 0.025 | 0.63 | 0.13 | 3.30 |
| 15D-110-XX | 15 Pin | 1.74 | 44.20 | 1.31 | 33.27 | 1.11 | 28.19 | 0.44 | 11.18 | 0.22 | 5.59 | 0.69 | 17.53 | 0.025 | 0.63 | 0.13 | 3.30 |
| 15D-100-SS | 15 Pin | 1.74 | 44.20 | 1.31 | 33.27 | 1.11 | 28.19 | 0.44 | 11.18 | 0.22 | 5.59 | 0.69 | 17.53 | 0.025 | 0.63 | 0.13 | 3.30 |
| 25D-110-XX | 25 Pin | 2.28 | 57.91 | 1.85 | 46.99 | 1.65 | 41.91 | 0.44 | 11.18 | 0.22 | 5.59 | 0.69 | 17.53 | 0.025 | 0.63 | 0.13 | 3.30 |
| 25D-100-SS | 25 Pin | 2.28 | 57.91 | 1.85 | 46.99 | 1.65 | 41.91 | 0.44 | 11.18 | 0.22 | 5.59 | 0.69 | 17.53 | 0.025 | 0.63 | 0.13 | 3.30 |
| 37D-110-XX | 37 Pin | 2.93 | 74.42 | 2.50 | 63.50 | 2.29 | 58.17 | 0.44 | 11.18 | 0.22 | 5.59 | 0.69 | 17.53 | 0.025 | 0.63 | 0.13 | 3.30 |
| 37D-100-SS | 37 Pin | 2.93 | 74.42 | 2.50 | 63.50 | 2.29 | 58.17 | 0.44 | 11.18 | 0.22 | 5.59 | 0.69 | 17.53 | 0.025 | 0.63 | 0.13 | 3.30 |
| 50D-110-XX | 50 Pin | 2.84 | 72.14 | 2.41 | 61.21 | 2.11 | 53.59 | 0.55 | 13.97 | 0.28 | 7.11 | 0.80 | 20.32 | 0.025 | 0.63 | 0.24 | 6.10 |
| 50D-100-SS | 50 Pin | 2.84 | 72.14 | 2.41 | 61.21 | 2.11 | 53.59 | 0.55 | 13.97 | 0.28 | 7.11 | 0.80 | 20.32 | 0.025 | 0.63 | 0.24 | 6.10 |

XX - Denotes the availability of finish/plating options. See chart above. Example: 09D-110-BD SS - Denotes stainless steel.



| D-Sub Miniature - Slotted | | Black = inches Blue = mm | | | | | | | | | | | | | | | |
|---------------------------|--------|--------------------------|-------|------|-------|------|-------|------|-------|------|------|------|-------|-------|------|------|------|
| PART NUMBER | TYPE | A | B | C | D | E | F | G | H | | | | | | | | |
| 09D-210-XX | 9 Pin | 1.41 | 35.81 | 0.98 | 24.89 | 0.78 | 19.81 | 0.44 | 11.18 | 0.22 | 5.59 | 0.69 | 17.53 | 0.025 | 0.63 | 0.13 | 3.30 |
| 09D-200-SS | 9 Pin | 1.41 | 35.81 | 0.98 | 24.89 | 0.78 | 19.81 | 0.44 | 11.18 | 0.22 | 5.59 | 0.69 | 17.53 | 0.025 | 0.63 | 0.13 | 3.30 |
| 15D-210-XX | 15 Pin | 1.74 | 44.20 | 1.31 | 33.27 | 1.11 | 28.19 | 0.44 | 11.18 | 0.22 | 5.59 | 0.69 | 17.53 | 0.025 | 0.63 | 0.13 | 3.30 |
| 15D-200-SS | 15 Pin | 1.74 | 44.20 | 1.31 | 33.27 | 1.11 | 28.19 | 0.44 | 11.18 | 0.22 | 5.59 | 0.69 | 17.53 | 0.025 | 0.63 | 0.13 | 3.30 |
| 25D-210-XX | 25 Pin | 2.28 | 57.91 | 1.85 | 46.99 | 1.65 | 41.91 | 0.44 | 11.18 | 0.22 | 5.59 | 0.69 | 17.53 | 0.025 | 0.63 | 0.13 | 3.30 |
| 25D-200-SS | 25 Pin | 2.28 | 57.91 | 1.85 | 46.99 | 1.65 | 41.91 | 0.44 | 11.18 | 0.22 | 5.59 | 0.69 | 17.53 | 0.025 | 0.63 | 0.13 | 3.30 |
| 37D-210-XX | 37 Pin | 2.93 | 74.42 | 2.50 | 63.50 | 2.29 | 58.17 | 0.44 | 11.18 | 0.22 | 5.59 | 0.69 | 17.53 | 0.025 | 0.63 | 0.13 | 3.30 |
| 37D-200-SS | 37 Pin | 2.93 | 74.42 | 2.50 | 63.50 | 2.29 | 58.17 | 0.44 | 11.18 | 0.22 | 5.59 | 0.69 | 17.53 | 0.025 | 0.63 | 0.13 | 3.30 |
| 50D-210-XX | 50 Pin | 2.84 | 72.14 | 2.41 | 61.21 | 2.11 | 53.59 | 0.55 | 13.97 | 0.28 | 7.11 | 0.80 | 20.32 | 0.025 | 0.63 | 0.24 | 6.10 |
| 50D-200-SS | 50 Pin | 2.84 | 72.14 | 2.41 | 61.21 | 2.11 | 53.59 | 0.55 | 13.97 | 0.28 | 7.11 | 0.80 | 20.32 | 0.025 | 0.63 | 0.24 | 6.10 |

XX - Denotes the availability of finish/plating options. See chart above. Example: 09D-210-BD SS - Denotes stainless steel.

* For fabric option - See page 34.



THIN GAUGE CUSTOM MECHANICAL SPRINGS & STAMPINGS

For over 30 years, Leader Tech has been supplying customers with high quality precision custom prototypes, short run and high volume stampings. Our in-house tool & die design and build expertise, combined with our extensive manufacturing capabilities, allow us to manufacture custom precision components for many applications. Our expertise is not limited to just the stamping portion of the application but can include value added operations such as the addition of insulating materials, hardware and other required features. From prototype to high volume production runs, Leader Tech can meet your custom needs with the shortest and most reliable lead times in the industry.

From prototypes within days to long production runs, your Leader Tech Team is ready to assist you. Please call us at 813-855-6921 or email us at sales@leadertechinc.com with your requirements.



CONDUCTIVE ELASTOMER EMI SHIELDING GASKETS FOR ELECTRONIC ENCLOSURES

Leader Tech's complete line of TechSIL Conductive Elastomer compounds is QPL certification by the Defense Logistics Agency. This unrivaled commitment to excellence distinguishes our company as the only MIL-SPEC approved & certified manufacturer of all 12 conductive elastomer formulations. This prestigious designation authorizes us to formulate, extrude and mold conductive elastomers to stringent MIL-DTL-83528D specifications.

Leader Tech's high-performance TechSIL gaskets are manufactured using proprietary base formulations of silicone, fluorosilicone and EPDM rubber that are embedded with highly conductive fillers including: Silver, Silver/Copper, Silver/Aluminum, Silver/Nickel, Silver/Glass, and Nickel Coated Graphite. We offer numerous standard gasket profiles as well as unlimited variations of extruded, molded, sheet stock, and die-cut finishes.

TechSIL Conductive Elastomers provide engineers with a highly customizable gasketing solution that delivers a shielding effectiveness of up to 110 dB across wide temperature variations and environmental conditions. An onsite applications engineer is also available to help formulate materials to meet your custom requirements. To learn more about this product line and our capabilities, make sure to request or download the complete TechSIL Conductive Elastomer catalog from our website.

MATERIAL TYPES & PROFILES

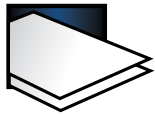

Sheet Material

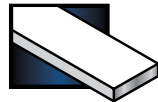

Extrusions



Molded



Die Cut



Get your catalog today!
Download from our website.

**The Only MIL-SPEC Approved & Certified Manufacturer
of All 12 Conductive Elastomer Compounds!**

MIL-DTL-83528 Approved



ORIENTED WIRE SERIES

Leader Tech's *TechSIL 8000 Oriented Wire* gasketing is designed for use in suppressing EMI/RFI up to 100 dB in the E-Field/up to 50 dB in the H-Field, while offering an effective environmental seal between mating surfaces. This material is comprised of monel or aluminum wire oriented perpendicular to the mating surfaces and embedded in solid or sponge silicone elastomer. The wires are crimped for additional resiliency and to optimize the mechanical performance of the gasket. The silicone based *TechSIL* has 700-900 wires per sq./in. and is capable of withstanding temperatures from -80° to a maximum of 500° F (-62° to 260°C). *TechSIL Oriented Wire* materials are available in strip or sheet form and can easily be die cut into complex shapes or fabricated into custom frame gaskets. All *TechSIL 8000* materials meet the DESC drawing 90046.



| TechSIL® Sheet | | | | |
|----------------|--------|------|-------|--------|
| PART NUMBER | HEIGHT | | WIDTH | |
| 8100-0005-XX | 0.032* | 0.81 | 3.00 | 76.20 |
| 8100-0010-XX | 0.032* | 0.81 | 4.50 | 114.30 |
| 8100-0015-XX | 0.032* | 0.81 | 6.00 | 152.40 |
| 8100-0020-XX | 0.062 | 1.57 | 3.00 | 76.20 |
| 8100-0025-XX | 0.062 | 1.57 | 4.50 | 114.30 |
| 8100-0030-XX | 0.062 | 1.57 | 6.00 | 152.40 |
| 8100-0035-XX | 0.093 | 2.36 | 3.00 | 76.20 |
| 8100-0040-XX | 0.093 | 2.36 | 4.50 | 114.30 |
| 8100-0045-XX | 0.093 | 2.36 | 6.00 | 152.40 |
| 8100-0050-XX | 0.125 | 3.18 | 3.00 | 76.20 |
| 8100-0055-XX | 0.125 | 3.18 | 4.50 | 114.30 |
| 8100-0060-XX | 0.125 | 3.18 | 6.00 | 152.40 |
| 8100-0065-XX | 0.188 | 4.78 | 3.00 | 76.20 |
| 8100-0070-XX | 0.188 | 4.78 | 4.50 | 114.30 |
| 8100-0075-XX | 0.188 | 4.78 | 6.00 | 152.40 |
| 8100-0080-XX | 0.250 | 6.35 | 3.00 | 76.20 |
| 8100-0085-XX | 0.250 | 6.35 | 4.50 | 114.30 |
| 8100-0090-XX | 0.250 | 6.35 | 6.00 | 152.40 |



Black = inches
Blue = mm

*0.032" thickness is only available in Silicone Solid

| TechSIL® Strip | | | | |
|----------------|--------|------|-------|-------|
| PART NUMBER | HEIGHT | | WIDTH | |
| 8200-0005-XX | 0.062 | 1.57 | 0.093 | 2.36 |
| 8200-0010-XX | 0.062 | 1.57 | 0.125 | 3.18 |
| 8200-0015-XX | 0.062 | 1.57 | 0.188 | 4.78 |
| 8200-0020-XX | 0.062 | 1.57 | 0.250 | 6.35 |
| 8200-0025-XX | 0.062 | 1.57 | 0.375 | 9.53 |
| 8200-0030-XX | 0.062 | 1.57 | 0.500 | 12.70 |
| 8200-0035-XX | 0.093 | 2.36 | 0.093 | 2.36 |
| 8200-0040-XX | 0.093 | 2.36 | 0.125 | 3.18 |
| 8200-0045-XX | 0.093 | 2.36 | 0.188 | 4.78 |
| 8200-0050-XX | 0.093 | 2.36 | 0.250 | 6.35 |
| 8200-0055-XX | 0.093 | 2.36 | 0.375 | 9.53 |
| 8200-0060-XX | 0.093 | 2.36 | 0.500 | 12.70 |
| 8200-0065-XX | 0.125 | 3.18 | 0.125 | 3.18 |
| 8200-0070-XX | 0.125 | 3.18 | 0.188 | 4.78 |
| 8200-0075-XX | 0.125 | 3.18 | 0.250 | 6.35 |
| 8200-0080-XX | 0.125 | 3.18 | 0.375 | 9.53 |
| 8200-0085-XX | 0.125 | 3.18 | 0.500 | 12.70 |
| 8200-0090-XX | 0.188 | 4.78 | 0.188 | 4.78 |
| 8200-0095-XX | 0.188 | 4.78 | 0.250 | 6.35 |
| 8200-0100-XX | 0.188 | 4.78 | 0.375 | 9.53 |
| 8200-0105-XX | 0.188 | 4.78 | 0.500 | 12.70 |
| 8200-0110-XX | 0.250 | 6.35 | 0.250 | 6.35 |
| 8200-0115-XX | 0.250 | 6.35 | 0.375 | 9.53 |
| 8200-0120-XX | 0.250 | 6.35 | 0.500 | 12.70 |



Black = inches
Blue = mm

| Material Code | Wire Specification | Elastomer |
|---------------|--|---|
| -81 | Monel Wire - 0.0045 Dia. (0.10) Per QQ-N-281 | Silicone Sponge Per AMS 3195 |
| -82 | Monel Wire - 0.0045 Dia. (0.10) Per QQ-N-281 | Silicone Solid ZZR765, Class 2B, Grade 40 |
| -83 | Aluminum Wire - 0.005 Dia. (0.13) Alloy 5056 | Silicone Sponge Per AMS 3195 |
| -84 | Aluminum Wire - 0.005 Dia. (0.13) Alloy 5056 | Silicone Solid ZZR765, Class 2B, Grade 40 |

All materials available with tape.

The data presented is accurate and true to our knowledge. Since applications, test methods and test procedures may vary, we recommend that users perform their own tests to assure suitability for specific applications. We offer no product warranty, either expressed or implied, except we will replace any product found to be defective.

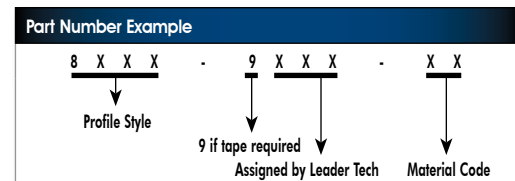

TECHMESH KNITTED WIRE

Leader Tech's *TechMESH Knitted Wire* gaskets are designed to provide EMI/RFI Shielding of joints and seams of electronic enclosures. The unique construction of the *TechMESH Knitted Wire* consists of many interlocking loops that act as small springs which provide for a resilient all-metal conductive gasket with high attenuation characteristics. *TechMESH* provides shielding effectiveness up to 130 dB in the E-Field and up to 80 dB in the H-Field. The standard wire materials are Tin Plated Copper Clad Steel, Monel and Aluminum in cross-sections of rectangular, round, round-with-fin, and double-round-with-fin. All cross-sections are available in both ALL Mesh or Elastomer Core configurations. The *TechMESH Knitted Wire* gaskets are supplied on spools of 25 ft. or cut to our customers specification.



Additional wire options are available upon request

| Round All Mesh | | |
|------------------|----------|-------|
| PART NUMBER | DIAMETER | |
| 7000-0005-XX | 0.062 | 1.57 |
| 7000-0010-XX | 0.093 | 2.36 |
| 7000-0015-XX | 0.125 | 3.18 |
| 7000-0020-XX | 0.156 | 3.96 |
| 7000-0025-XX | 0.188 | 4.78 |
| 7000-0030-XX | 0.250 | 6.35 |
| 7000-0035-XX | 0.312 | 7.92 |
| 7000-0040-XX | 0.375 | 9.53 |
| 7000-0055-XX | 0.500 | 12.70 |

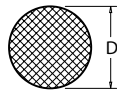

Black = inches
Blue = mm

Tape is not available.

| Rectangular All Mesh | | | | |
|------------------------|--------|------|-------|-------|
| PART NUMBER | HEIGHT | | WIDTH | |
| 7200-0005-XX | 0.062 | 1.57 | 0.062 | 1.57 |
| 7200-0010-XX | 0.062 | 1.57 | 0.125 | 3.18 |
| 7200-0015-XX | 0.062 | 1.57 | 0.250 | 6.35 |
| 7200-0020-XX | 0.093 | 2.36 | 0.093 | 2.36 |
| 7200-0025-XX | 0.093 | 2.36 | 0.125 | 3.18 |
| 7200-0030-XX | 0.093 | 2.36 | 0.250 | 6.35 |
| 7200-0035-XX | 0.125 | 3.18 | 0.125 | 3.18 |
| 7200-0040-XX | 0.125 | 3.18 | 0.250 | 6.35 |
| 7200-0045-XX | 0.125 | 3.18 | 0.500 | 12.70 |
| 7200-0050-XX | 0.188 | 4.78 | 0.188 | 4.78 |
| 7200-0055-XX | 0.188 | 4.78 | 0.500 | 12.70 |
| 7200-0060-XX | 0.250 | 6.35 | 0.250 | 6.35 |
| 7200-0065-XX | 0.250 | 6.35 | 0.500 | 12.70 |



Black = inches
Blue = mm

| Round All Mesh with Fin | | | | |
|---------------------------|----------|-------|-------|-------|
| PART NUMBER | DIAMETER | WIDTH | | |
| 7100-0005-XX | 0.062 | 1.57 | 0.375 | 9.53 |
| 7100-0010-XX | 0.062 | 1.57 | 0.500 | 12.70 |
| 7100-0015-XX | 0.093 | 2.36 | 0.375 | 9.53 |
| 7100-0020-XX | 0.093 | 2.36 | 0.500 | 12.70 |
| 7100-0025-XX | 0.125 | 3.18 | 0.375 | 9.53 |
| 7100-0030-XX | 0.125 | 3.18 | 0.500 | 12.70 |
| 7100-0035-XX | 0.188 | 4.78 | 0.500 | 12.70 |
| 7100-0040-XX | 0.188 | 4.78 | 0.750 | 19.05 |
| 7100-0045-XX | 0.250 | 6.35 | 0.500 | 12.70 |
| 7100-0050-XX | 0.250 | 6.35 | 0.750 | 19.05 |
| 7100-0055-XX | 0.312 | 7.92 | 0.875 | 22.23 |
| 7100-0060-XX | 0.375 | 9.53 | 0.750 | 19.05 |
| 7100-0065-XX | 0.500 | 12.70 | 0.750 | 19.05 |



Black = inches
Blue = mm

Tape is not available.

| Double Round All Mesh with Fin | | | | |
|----------------------------------|----------|-------|------|-------|
| PART NUMBER | DIAMETER | WIDTH | | |
| 7300-0005-XX | 0.062 | 1.57 | 0.38 | 9.65 |
| 7300-0010-XX | 0.062 | 1.57 | 0.50 | 12.70 |
| 7300-0015-XX | 0.062 | 1.57 | 0.75 | 19.05 |
| 7300-0020-XX | 0.093 | 2.36 | 0.50 | 12.70 |
| 7300-0025-XX | 0.125 | 3.18 | 0.50 | 12.70 |
| 7300-0030-XX | 0.125 | 3.18 | 0.75 | 19.05 |
| 7300-0035-XX | 0.125 | 3.18 | 1.00 | 25.40 |
| 7300-0040-XX | 0.188 | 4.78 | 0.63 | 16.00 |
| 7300-0045-XX | 0.188 | 4.78 | 0.75 | 19.05 |
| 7300-0050-XX | 0.188 | 4.78 | 1.00 | 25.40 |
| 7300-0055-XX | 0.250 | 6.35 | 0.75 | 19.05 |
| 7300-0060-XX | 0.250 | 6.35 | 1.00 | 25.40 |
| 7300-0065-XX | 0.375 | 9.53 | 1.00 | 25.40 |



Black = inches
Blue = mm

Tape is not available.

| Material Code | Wire Specification |
|---------------|--|
| -71 | Tin Plated Copper Clad Steel - 0.0045 Dia. (0.10) ASTM-B-520 |
| -72 | Monel Wire - 0.0045 Dia. (0.10) Per QQ-N-281 |
| -73 | Aluminum Wire - 0.005 Dia. (0.13) Alloy 5056, Per AMS-4182 |

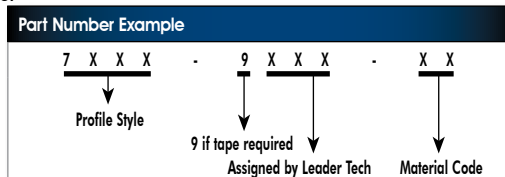

TECHMESH ELASTOMER CORE WIRE

| Material Code | Wire Specification | Elastomer |
|---------------|--|---|
| -74 | Monel Wire - 0.0045 Dia. (0.10) Per QQ-N-281B | Neoprene Sponge MIL-R-6130B, Type II, Grade A |
| -75 | Monel Wire - 0.0045 Dia. (0.10) Per QQ-N-281B | Silicone Sponge Per AMS 3195 |
| -76 | Monel Wire - 0.0045 Dia. (0.10) Per QQ-N-281B | Silicone Solid Per ZZR765, Class 2B, Grade 40 |
| -77 | Tin Plated Copper Clad Steel 0.0045 Dia. (0.10) ASTM-B-520 | Neoprene Sponge MIL-R-6130B, Type II, Grade A |
| -78 | Tin Plated Copper Clad Steel 0.0045 Dia. (0.10) ASTM-B-520 | Silicone Sponge Per AMS 3195 |
| -79 | Tin Plated Copper Clad Steel 0.0045 Dia. (0.10) ASTM-B-520 | Silicone Solid Per ZZR765, Class 2B, Grade 40 |



Solid | Elastomer Mesh

| PART NUMBER | DIAMETER | |
|--------------|----------|-------|
| 7400-0005-XX | 0.062 | 1.57 |
| 7400-0010-XX | 0.125 | 3.18 |
| 7400-0015-XX | 0.188 | 4.78 |
| 7400-0020-XX | 0.250 | 6.35 |
| 7400-0025-XX | 0.312 | 7.92 |
| 7400-0030-XX | 0.375 | 9.53 |
| 7400-0035-XX | 0.500 | 12.70 |



Black = inches
Blue = mm

Tape is not available.

Hollow | Elastomer Mesh

| PART NUMBER | DIAMETER | |
|--------------|----------|-------|
| 7600-0005-XX | 0.188 | 4.78 |
| 7600-0010-XX | 0.250 | 6.35 |
| 7600-0015-XX | 0.375 | 9.53 |
| 7600-0020-XX | 0.500 | 12.70 |

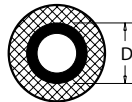

Black = inches
Blue = mm

Tape is not available.
Not available in -75 or -78 material

Rectangular | Elastomer Mesh

| PART NUMBER | HEIGHT | | WIDTH | |
|--------------|--------|-------|-------|-------|
| 7500-0005-XX | 0.125 | 3.18 | 0.125 | 3.18 |
| 7500-0010-XX | 0.125 | 3.18 | 0.188 | 4.78 |
| 7500-0015-XX | 0.125 | 3.18 | 0.250 | 6.35 |
| 7500-0020-XX | 0.188 | 4.78 | 0.188 | 4.78 |
| 7500-0025-XX | 0.250 | 6.35 | 0.250 | 6.35 |
| 7500-0030-XX | 0.250 | 6.35 | 0.375 | 9.53 |
| 7500-0035-XX | 0.250 | 6.35 | 0.500 | 12.70 |
| 7500-0040-XX | 0.375 | 9.53 | 0.500 | 12.70 |
| 7500-0045-XX | 0.500 | 12.70 | 0.500 | 12.70 |
| 7500-0050-XX | 0.500 | 12.70 | 0.750 | 19.05 |

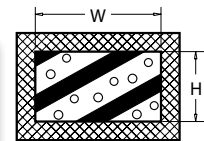

Black = inches
Blue = mm

P-Bulb | Elastomer Mesh

| PART NUMBER | DIAMETER | WIDTH | |
|--------------|----------|-------|-------|
| 7700-0005-XX | 0.125 | 3.18 | 0.500 |
| 7700-0010-XX | 0.125 | 3.18 | 0.625 |
| 7700-0015-XX | 0.125 | 3.18 | 0.750 |
| 7700-0020-XX | 0.188 | 4.78 | 0.500 |
| 7700-0025-XX | 0.188 | 4.78 | 0.625 |
| 7700-0030-XX | 0.188 | 4.78 | 0.750 |
| 7700-0035-XX | 0.250 | 6.35 | 0.500 |
| 7700-0040-XX | 0.250 | 6.35 | 0.750 |
| 7700-0045-XX | 0.250 | 6.35 | 1.000 |
| 7700-0050-XX | 0.500 | 12.70 | 1.000 |

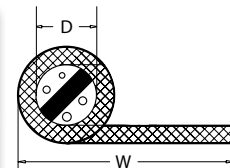

Black = inches
Blue = mm

Part Number Example



TECHMESH COMBO STRIP

Leader Tech's *TechMesh Combo Strip & Gaskets* are designed for use in applications requiring EMI/RFI shielding and environmental sealing. These materials are comprised of monel or tin plated copper clad steel knitted wire mesh which are bonded to neoprene sponge, silicone sponge or silicone solid elastomer strips. The wire mesh provides shielding performance up to 125 dB in the E-Field and up to 80 dB in the H-Field while the elastomer materials can withstand temperatures from -103° to a maximum of 500° F (-75° to 260°C). These materials have an optional pressure sensitive adhesive backing for ease of installation. The *TechMesh Combo Strip & Gaskets* are available in standard and custom strip configurations. Leader Tech can also fabricate custom frame gaskets to customers specification.



Additional wire options or metal compression stops are available upon request.



| Single Mesh Combo Gasket | | | | | | | | |
|----------------------------|------------|------|-----------|-------|------------|------|-----------|------|
| PART NUMBER | ELASTOMER | | | | MESH | | | |
| | HEIGHT (A) | | WIDTH (B) | | HEIGHT (C) | | WIDTH (D) | |
| 7800-0005-XX | 0.062 | 1.57 | 0.250 | 6.35 | 0.062 | 1.57 | 0.125 | 3.18 |
| 7800-0010-XX | 0.062 | 1.57 | 0.375 | 9.53 | 0.062 | 1.57 | 0.125 | 3.18 |
| 7800-0015-XX | 0.062 | 1.57 | 0.500 | 12.70 | 0.062 | 1.57 | 0.125 | 3.18 |
| 7800-0020-XX | 0.093 | 2.36 | 0.250 | 6.35 | 0.093 | 2.36 | 0.125 | 3.18 |
| 7800-0025-XX | 0.093 | 2.36 | 0.375 | 9.53 | 0.093 | 2.36 | 0.125 | 3.18 |
| 7800-0030-XX | 0.093 | 2.36 | 0.500 | 12.70 | 0.093 | 2.36 | 0.125 | 3.18 |
| 7800-0035-XX | 0.125 | 3.18 | 0.250 | 6.35 | 0.125 | 3.18 | 0.125 | 3.18 |
| 7800-0040-XX | 0.125 | 3.18 | 0.375 | 9.53 | 0.125 | 3.18 | 0.125 | 3.18 |
| 7800-0045-XX | 0.125 | 3.18 | 0.500 | 12.70 | 0.125 | 3.18 | 0.125 | 3.18 |
| 7800-0050-XX | 0.125 | 3.18 | 0.750 | 19.05 | 0.125 | 3.18 | 0.125 | 3.18 |
| 7800-0055-XX | 0.188 | 4.78 | 0.375 | 9.53 | 0.188 | 4.78 | 0.125 | 3.18 |
| 7800-0060-XX | 0.188 | 4.78 | 0.500 | 12.70 | 0.188 | 4.78 | 0.125 | 3.18 |
| 7800-0065-XX | 0.188 | 4.78 | 0.750 | 19.05 | 0.188 | 4.78 | 0.125 | 3.18 |
| 7800-0070-XX | 0.250 | 6.35 | 0.500 | 12.70 | 0.250 | 6.35 | 0.125 | 3.18 |
| 7800-0075-XX | 0.250 | 6.35 | 0.750 | 19.05 | 0.250 | 6.35 | 0.125 | 3.18 |

Black = inches
Blue = mm

| Double Mesh Combo Gasket | | | | | | | | |
|----------------------------|------------|------|-----------|-------|------------|------|-----------|------|
| PART NUMBER | ELASTOMER | | | | MESH | | | |
| | HEIGHT (A) | | WIDTH (B) | | HEIGHT (C) | | WIDTH (D) | |
| 7900-0005-XX | 0.062 | 1.57 | 0.250 | 6.35 | 0.062 | 1.57 | 0.125 | 3.18 |
| 7900-0010-XX | 0.062 | 1.57 | 0.500 | 12.70 | 0.062 | 1.57 | 0.125 | 3.18 |
| 7900-0015-XX | 0.093 | 2.36 | 0.250 | 6.35 | 0.093 | 2.36 | 0.125 | 3.18 |
| 7900-0020-XX | 0.093 | 2.36 | 0.500 | 12.70 | 0.093 | 2.36 | 0.125 | 3.18 |
| 7900-0025-XX | 0.125 | 3.18 | 0.250 | 6.35 | 0.125 | 3.18 | 0.125 | 3.18 |
| 7900-0030-XX | 0.125 | 3.18 | 0.375 | 9.53 | 0.125 | 3.18 | 0.125 | 3.18 |
| 7900-0035-XX | 0.125 | 3.18 | 0.500 | 12.70 | 0.125 | 3.18 | 0.125 | 3.18 |
| 7900-0040-XX | 0.188 | 4.78 | 0.250 | 6.35 | 0.188 | 4.78 | 0.125 | 3.18 |
| 7900-0045-XX | 0.188 | 4.78 | 0.500 | 12.70 | 0.188 | 4.78 | 0.125 | 3.18 |

Black = inches
Blue = mm



| Material Code | Wire Specification | Elastomer |
|---------------|--|---|
| -74 | Monel Wire - 0.0045 Dia. (0.10) Per QQ-N-281B | Neoprene Sponge MIL-R-6130B, Type II, Grade A |
| -75 | Monel Wire - 0.0045 Dia. (0.10) Per QQ-N-281B | Silicone Sponge Per AMS 3195 |
| -76 | Monel Wire - 0.0045 Dia. (0.10) Per QQ-N-281B | Silicone Solid Per ZZR765, Class 2B, Grade 40 |
| -77 | Tin Plated Copper Clad Steel 0.0045 Dia. (0.10) ASTM-B-520 | Neoprene Sponge MIL-R-6130B, Type II, Grade A |
| -78 | Tin Plated Copper Clad Steel 0.0045 Dia. (0.10) ASTM-B-520 | Silicone Sponge Per AMS 3195 |
| -79 | Tin Plated Copper Clad Steel 0.0045 Dia. (0.10) ASTM-B-520 | Silicone Solid Per ZZR765, Class 2B, Grade 40 |

The data presented is accurate and true to our knowledge. Since applications, test methods and test procedures may vary, we recommend that users perform their own tests to assure suitability for specific applications. We offer no product warranty, either expressed or implied, except we will replace any product found to be defective.

TECHMESH TAPE

Leader Tech's **TechMESH Tape** has double layered strip of knitted wire mesh to provide effective EMI shielding and grounding for electric and electronic cable assemblies. This is particularly useful in applications where the need for EMI protection is determined after the cable assembly is complete and standard braided shielded cable cannot be used. The flexible structure of Leader **TechMESH Tape** permits it to conform to irregular surfaces and the cable contours during the wrapping process. **TechMESH Tape** is 0.020" (0,51mm) thick. It is available in tin plated copper clad steel (-71) or Monel (-72) width 10-12 openings per inch.



Performance Advantages

- Tin plated for excellent solderability
- Useful in both shielding and grounding applications for static discharge
- Tin plated copper clad steel wire provides greater strength and performance than other mesh tape materials
- Knit loop structure provides uniform coverage minimizing wrinkles and creases
- Available in other alloys and wire dimensions
- Supplied in 50 ft. (15,2mm) rolls (Note: When determining quantity needed, 50% overlap is recommended)

| 6000 Tape | | |
|--------------|----------------|---------------|
| PART NUMBER | WIDTH | |
| 6000-0025-XX | 0.250 +/- 0.40 | 6.4 +/- 1.0 |
| 6000-0038-XX | 0.380 +/- 0.40 | 9.7 +/- 1.0 |
| 6000-0050-XX | 0.500 +/- 0.60 | 12.7 +/- 1.5 |
| 6000-0075-XX | 0.750 +/- 0.60 | 19.1 +/- 24.4 |
| 6000-0100-XX | 1.00 +/- 0.60 | 25.4 +/- 1.5 |
| 6000-0150-XX | 1.50 +/- 0.120 | 38.1 +/- 3.1 |
| 6000-0175-XX | 1.75 +/- 0.120 | 44.5 +/- 3.1 |
| 6000-0225-XX | 2.25 +/- 0.120 | 57.2 +/- 4.8 |

Black = inches
Blue = mm

| 6000 Tape | |
|---------------|--|
| MATERIAL CODE | WIRE SPECIFICATION |
| -71 | Tin Plated Copper Clad Steel - 0.0045 Dia. (0.10) ASTM-B-520 |
| -72 | Monel Wire - 0.0045 Dia. (0.10) Per QQ-N-281 |

| Part Number Explanation | | |
|-------------------------|------------------------------|---------------|
| 6 0 0 0 | - X X X X - | X X |
| ↓ | ↓ | ↓ |
| Profile Style | Select Size from chart above | Material Code |

TECHNICAL DATA

Shielding gaskets are, very simply, connectors of two opposing metallic planes which make them appear as one continuous surface, by connecting across the openings. Depending on the frequencies involved, the openings must be reduced as closely as possible to a continuous seal.

Leader Tech's unique Fabric Shielding Gasket structure is a combination of a highly conductive nickel/copper ripstop fabric and a resilient polyurethane foam core. Leader Tech's FSG products have superior shielding properties and ensure long performance life all in a cost effective manner.

Leader Tech (FSG):

Fabric: Nickel/Copper RipStop

Foam: Open Cell Polyurethane

Compression Set: <15% (ASTM D3574)

Temperature Range: -40°F to 158°F (-40°C to 70°C) (ASTM D746)

Surface Resistivity: ≤0.050 Ω/inch² (ASTM F390)

Flammability Rating: UL94V0

Shielding Effectiveness: >Up to 105 dB (MIL-DTL-83528C)

Pressure Sensitive Adhesive: Non-conductive, high peel strength

ROHS: Compliant

REACH: Compliant

SHELF LIFE: If stored properly, product retains its performance and properties for 24 months from date of manufacture. (It is suggested that products are stored at room temperature conditions of 70°F (21°C) and 50% relative humidity.)

Tolerances:

TYPICAL CROSS SECTION TOLERANCES

±.010 in. (0.25 mm) for all dimensions up to 0.04 in. (1.02 mm)

±.020 in. (0.50 mm) for all dimensions above 0.04 in. (1.02 mm)

(Detailed part drawings are available upon request)

TYPICAL LENGTH TOLERANCES

| | | | |
|--------------------|-----------------|----------|-----------|
| 0.20 to 6.00 in. | (5 - 152 mm) | ±.03 in. | (0.76 mm) |
| 6.01 to 18.00 in. | (153 - 457 mm) | ±.06 in. | (1.52 mm) |
| 18.01 to 48.00 in. | (458 - 1219 mm) | ±.08 in. | (2.03 mm) |

*Other sizes available.
Consult factory.

Shelf-life is based on the pressure sensitive adhesive which is 24 months



FSG FOR ELECTRONIC ENCLOSURES

| Square Shape | | | | | | |
|--------------|--------|-------|--------|-------|----|------|
| PART NUMBER | HEIGHT | WIDTH | LENGTH | | | |
| SG080080S | 0.080 | 2.03 | 0.080 | 2.03 | 48 | 1219 |
| SG118118S | 0.118 | 3.00 | 0.118 | 3.00 | 48 | 1219 |
| SG138138S | 0.138 | 3.54 | 0.138 | 3.54 | 48 | 1219 |
| SG160160S | 0.160 | 4.06 | 0.160 | 4.06 | 48 | 1219 |
| SG200200S | 0.200 | 5.08 | 0.200 | 5.08 | 48 | 1219 |
| SG250250S | 0.250 | 6.35 | 0.250 | 6.35 | 48 | 1219 |
| SG315315S | 0.315 | 8.00 | 0.315 | 8.00 | 48 | 1219 |
| SG354354S | 0.354 | 8.99 | 0.354 | 8.99 | 48 | 1219 |
| SG375375S | 0.375 | 9.52 | 0.375 | 9.52 | 48 | 1219 |
| SG472472S | 0.472 | 11.99 | 0.472 | 11.99 | 48 | 1219 |
| SG500500S | 0.500 | 12.70 | 0.500 | 12.70 | 48 | 1219 |
| SG512512S | 0.512 | 13.00 | 0.512 | 13.00 | 48 | 1219 |
| SG551551S | 0.551 | 14.00 | 0.551 | 14.00 | 48 | 1219 |
| SG575575S | 0.575 | 14.60 | 0.575 | 14.60 | 48 | 1219 |
| SG591591S | 0.591 | 15.01 | 0.591 | 15.01 | 48 | 1219 |
| SG670670S | 0.670 | 17.02 | 0.670 | 17.02 | 48 | 1219 |
| SG787787S | 0.787 | 19.99 | 0.787 | 19.99 | 48 | 1219 |

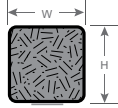

Black = inches
Blue = mm

| Bell Shape | | | | | | |
|-------------|--------|-------|--------|-------|----|------|
| PART NUMBER | HEIGHT | WIDTH | LENGTH | | | |
| SG070180B | 0.070 | 1.78 | 0.180 | 4.57 | 48 | 1219 |
| SG090315B | 0.090 | 2.29 | 0.315 | 8.00 | 48 | 1219 |
| SG098299B | 0.098 | 2.49 | 0.299 | 7.59 | 48 | 1219 |
| SG100300B | 0.100 | 2.54 | 0.300 | 7.62 | 48 | 1219 |
| SG130256B | 0.130 | 3.30 | 0.256 | 6.50 | 48 | 1219 |
| SG157500B | 0.157 | 3.99 | 0.500 | 12.70 | 48 | 1219 |
| SG200500B | 0.200 | 5.08 | 0.500 | 12.70 | 48 | 1219 |

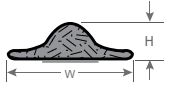

Black = inches
Blue = mm

| T-Shape | | | | | | |
|-------------|--------|-------|--------|------|----|------|
| PART NUMBER | HEIGHT | WIDTH | LENGTH | | | |
| SG152235T | 0.152 | 3.86 | 0.235 | 5.97 | 48 | 1219 |
| SG157245T | 0.157 | 3.99 | 0.245 | 6.22 | 48 | 1219 |
| SG175244T | 0.175 | 4.44 | 0.244 | 6.20 | 48 | 1219 |
| SG244244T | 0.244 | 6.20 | 0.244 | 6.20 | 48 | 1219 |



Black = inches
Blue = mm

| C-Shape | | | | | | |
|-------------|--------|--------|--------|-------|----|------|
| PART NUMBER | HEIGHT | WIDTH | LENGTH | | | |
| SG196325C | 0.196 | 4.98 | 0.325 | 8.25 | 48 | 1219 |
| SG196535C | 0.196 | 4.98 | 0.535 | 13.59 | 48 | 1219 |
| SG240415C | 0.240 | 6.10 | 0.415 | 10.54 | 48 | 1219 |
| SG252280C | 0.252 | 6.40 | 0.280 | 7.11 | 48 | 1219 |
| SG315315C | 0.315 | 8.00 | 0.315 | 8.00 | 48 | 1219 |
| SG347685C | 0.347 | 8.81 | 0.685 | 17.40 | 48 | 1219 |
| SG380420C | 0.380 | 9.65 | 0.420 | 10.67 | 48 | 1219 |
| SG385420C | 0.385 | 9.78 | 0.420 | 10.67 | 48 | 1219 |
| SG465420C | 0.465 | 11.811 | 0.420 | 10.67 | 48 | 1219 |
| SG550590C | 0.550 | 13.97 | 0.590 | 14.99 | 48 | 1219 |
| SG675580C | 0.675 | 17.14 | 0.580 | 14.73 | 48 | 1219 |
| SG675600C | 0.675 | 17.14 | 0.600 | 15.24 | 48 | 1219 |

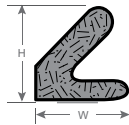

Black = inches
Blue = mm

Typical Performance

Shielding Effectiveness
80 - 115dB

Frequency Range
20Mhz - 10GHz

Dura-Layer Construction
Polyurethane foam core with high-performance fabric

Recommended Compression
30-50% of gasket height

| Typical Cross Section Tolerances | | | |
|--|------------------------------------|----------|-----------|
| ±.010 in. | (0.25 mm) for all dimensions up to | 0.04 in. | (1.02 mm) |
| ±.020 in. | (0.50 mm) for all dimensions above | 0.04 in. | (1.02 mm) |
| Detailed part drawings are available upon request. | | | |
| Typical Length Tolerances | | | |
| 0.20 to 6.00 in. | (5 - 152 mm) | ±.03 in. | (0.76 mm) |
| 6.01 to 18.00 in. | (153 - 457 mm) | ±.06 in. | (1.52 mm) |
| 18.01 to 48.00 in. | (458 - 1219 mm) | ±.08 in. | (2.03 mm) |

| Part Number Explanation | | | | |
|---|--------|-------|---------|-------------|
| SG | X X X | X X X | X | - X X . X X |
| ↓ | ↓ | ↓ | ↓ | ↓ |
| #Start | Height | Width | Profile | Length |
| *Example: SG125250D-22.50: Gasket .125 tall, .250 wide, D-Shape and 22.5" long | | | | |

FSG FOR ELECTRONIC ENCLOSURES *CONT.*

| Rectangle Shape | | | | | | |
|-----------------|--------|------|-------|-------|--------|------|
| PART NUMBER | HEIGHT | | WIDTH | | LENGTH | |
| SG020157R | 0.020 | 0.51 | 0.157 | 3.99 | 48 | 1219 |
| SG020197R | 0.020 | 0.51 | 0.197 | 5.00 | 48 | 1219 |
| SG020275R | 0.020 | 0.51 | 0.275 | 6.98 | 48 | 1219 |
| SG0391181R | 0.039 | 0.99 | 1.181 | 30.00 | 48 | 1219 |
| SG039118R | 0.039 | 0.99 | 0.118 | 3.00 | 48 | 1219 |
| SG040125R | 0.040 | 1.02 | 0.125 | 3.17 | 48 | 1219 |
| SG0401850R | 0.040 | 1.02 | 1.850 | 46.99 | 48 | 1219 |
| SG040200R | 0.040 | 1.02 | 0.200 | 5.08 | 48 | 1219 |
| SG040275R | 0.040 | 1.02 | 0.275 | 6.98 | 48 | 1219 |
| SG040395R | 0.040 | 1.02 | 0.395 | 10.03 | 48 | 1219 |
| SG040590R | 0.040 | 1.02 | 0.590 | 14.99 | 48 | 1219 |
| SG040710R | 0.040 | 1.02 | 0.710 | 18.03 | 48 | 1219 |
| SG050090R | 0.050 | 1.27 | 0.090 | 2.29 | 48 | 1219 |
| SG051157R | 0.051 | 1.30 | 0.157 | 3.99 | 48 | 1219 |
| SG051394R | 0.051 | 1.30 | 0.394 | 10.01 | 48 | 1219 |
| SG060100R | 0.060 | 1.52 | 0.100 | 2.54 | 48 | 1219 |
| SG060125R | 0.060 | 1.52 | 0.125 | 3.17 | 48 | 1219 |
| SG060130R | 0.060 | 1.52 | 0.130 | 3.30 | 48 | 1219 |
| SG060160R | 0.060 | 1.52 | 0.160 | 4.06 | 48 | 1219 |
| SG060200R | 0.060 | 1.52 | 0.200 | 5.08 | 48 | 1219 |
| SG060280R | 0.060 | 1.52 | 0.280 | 7.11 | 48 | 1219 |
| SG060394R | 0.060 | 1.52 | 0.394 | 10.01 | 48 | 1219 |
| SG060395R | 0.060 | 1.52 | 0.395 | 10.03 | 48 | 1219 |
| SG060750R | 0.060 | 1.52 | 0.750 | 19.05 | 48 | 1219 |
| SG079157R | 0.079 | 2.00 | 0.157 | 3.99 | 48 | 1219 |
| SG0801000R | 0.080 | 2.03 | 1.000 | 25.40 | 48 | 1219 |
| SG080100R | 0.080 | 2.03 | 0.100 | 2.54 | 48 | 1219 |
| SG080160R | 0.080 | 2.03 | 0.160 | 4.06 | 48 | 1219 |
| SG080200R | 0.080 | 2.03 | 0.200 | 5.08 | 48 | 1219 |
| SG080500R | 0.080 | 2.03 | 0.500 | 12.70 | 48 | 1219 |
| SG080750R | 0.080 | 2.03 | 0.750 | 19.05 | 48 | 1219 |
| SG100200R | 0.100 | 2.54 | 0.200 | 5.08 | 48 | 1219 |
| SG118118R | 0.118 | 3.00 | 0.118 | 3.00 | 48 | 1219 |
| SG120155R | 0.120 | 3.05 | 0.155 | 3.94 | 48 | 1219 |
| SG125250R | 0.125 | 3.17 | 0.250 | 6.35 | 48 | 1219 |
| SG125375R | 0.125 | 3.17 | 0.375 | 9.52 | 48 | 1219 |
| SG140250R | 0.140 | 3.56 | 0.250 | 6.35 | 48 | 1219 |

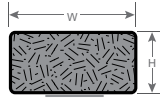

Black = inches
Blue = mm

| Rectangle Shape <i>cont.</i> | | | | | | |
|------------------------------|--------|-------|-------|-------|--------|------|
| PART NUMBER | HEIGHT | | WIDTH | | LENGTH | |
| SG157590R | 0.157 | 3.99 | 0.590 | 14.99 | 48 | 1219 |
| SG160354R | 0.160 | 4.06 | 0.354 | 8.99 | 48 | 1219 |
| SG250375R | 0.250 | 6.35 | 0.375 | 9.52 | 48 | 1219 |
| SG250500R | 0.250 | 6.35 | 0.500 | 12.70 | 48 | 1219 |
| SG250600R | 0.250 | 6.35 | 0.600 | 15.24 | 48 | 1219 |
| SG187375R | 0.187 | 4.75 | 0.375 | 9.52 | 48 | 1219 |
| SG187750R | 0.187 | 4.75 | 0.750 | 19.05 | 48 | 1219 |
| SG197315R | 0.197 | 5.00 | 0.315 | 8.00 | 48 | 1219 |
| SG200200R | 0.200 | 5.08 | 0.200 | 5.08 | 48 | 1219 |
| SG250250R | 0.250 | 6.35 | 0.250 | 6.35 | 48 | 1219 |
| SG375500R | 0.375 | 9.52 | 0.500 | 12.70 | 48 | 1219 |
| SG500500R | 0.500 | 12.70 | 0.500 | 12.70 | 48 | 1219 |
| SG500750R | 0.500 | 12.70 | 0.750 | 19.05 | 48 | 1219 |
| SG670670R | 0.670 | 17.02 | 0.670 | 17.02 | 48 | 1219 |
| SG787787R | 0.787 | 19.99 | 0.787 | 19.99 | 48 | 1219 |

Black = inches
Blue = mm

| Knife Edge | | | | | | |
|-------------|--------|------|-------|-------|--------|------|
| PART NUMBER | HEIGHT | | WIDTH | | LENGTH | |
| SG070340K | 0.070 | 1.78 | 0.340 | 8.64 | 48 | 1219 |
| SG106315K | 0.106 | 2.69 | 0.315 | 8.00 | 48 | 1219 |
| SG106445K | 0.106 | 2.69 | 0.445 | 11.30 | 48 | 1219 |
| SG106455K | 0.106 | 2.69 | 0.455 | 11.56 | 48 | 1219 |
| SG-160600K | 0.106 | 2.69 | 0.600 | 15.24 | 48 | 1219 |
| SG187236K | 0.187 | 4.75 | 0.236 | 5.99 | 48 | 1219 |
| SG250750K | 0.250 | 6.35 | 0.750 | 19.05 | 48 | 1219 |
| SG312707K | 0.312 | 7.92 | 0.270 | 6.86 | 48 | 1219 |
| SG350750K | 0.350 | 8.89 | 0.750 | 19.05 | 48 | 1219 |



Black = inches
Blue = mm

| Round Shape | | | |
|-------------|----------|------|---------|
| PART NUMBER | DIAMETER | | LENGTH |
| SG100100Z | 0.100 | 2.54 | 48 1219 |
| SG125125Z | 0.125 | 3.17 | 48 1219 |
| SG160160Z | 0.160 | 4.06 | 48 1219 |
| SG200200Z | 0.200 | 5.08 | 48 1219 |

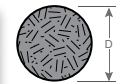

Black = inches
Blue = mm

Tape is not available.

| Typical Cross Section Tolerances | | |
|--|--------------------------|--------------------|
| ±.010 in. (0.25 mm) | for all dimensions up to | 0.04 in. (1.02 mm) |
| ±.020 in. (0.50 mm) | for all dimensions above | 0.04 in. (1.02 mm) |
| Detailed part drawings are available upon request. | | |
| Typical Length Tolerances | | |
| 0.20 to 6.00 in. (5 - 152 mm) | | ±.03 in. (0.76 mm) |
| 6.01 to 18.00 in. (153 - 457 mm) | | ±.06 in. (1.52 mm) |
| 18.01 to 48.00 in. (458 - 1219 mm) | | ±.08 in. (2.03 mm) |

| Part Number Explanation | | | | |
|---|--------|-------|---------|-----------|
| SG | X X X | X X X | X | X X . X X |
| ↓ | ↓ | ↓ | ↓ | ↓ |
| #Start | Height | Width | Profile | Length |
| *Example: SG125250D-22.50: Gasket .125 tall, .250 wide, D-Shape and 22.5" long | | | | |

FSG FOR ELECTRONIC ENCLOSURES CONT.

| D-Shape | | | | | | |
|-------------|--------|-------|--------|-------|----|------|
| PART NUMBER | HEIGHT | WIDTH | LENGTH | | | |
| SG040150D | 0.040 | 1.02 | 0.150 | 3.81 | 48 | 1219 |
| SG040200D | 0.040 | 1.02 | 0.200 | 5.08 | 48 | 1219 |
| SG050140D | 0.050 | 1.27 | 0.140 | 3.56 | 48 | 1219 |
| SG050250D | 0.050 | 1.27 | 0.250 | 6.35 | 48 | 1219 |
| SG060125D | 0.060 | 1.52 | 0.125 | 3.17 | 48 | 1219 |
| SG060150D | 0.060 | 1.52 | 0.150 | 3.81 | 48 | 1219 |
| SG060250D | 0.060 | 1.52 | 0.250 | 6.35 | 48 | 1219 |
| SG070135D | 0.070 | 1.78 | 0.135 | 3.43 | 48 | 1219 |
| SG70180D | 0.070 | 1.78 | 0.180 | 4.57 | 48 | 1219 |
| SG080080D | 0.080 | 2.03 | 0.080 | 2.03 | 48 | 1219 |
| SG080160D | 0.080 | 2.03 | 0.160 | 4.06 | 48 | 1219 |
| SG080394D | 0.080 | 2.03 | 0.394 | 10.01 | 48 | 1219 |
| SG090090D | 0.090 | 2.29 | 0.090 | 2.29 | 48 | 1219 |
| SG090150D | 0.090 | 2.29 | 0.150 | 3.81 | 48 | 1219 |
| SG094200D | 0.094 | 2.39 | 0.200 | 5.08 | 48 | 1219 |
| SG100300D | 0.100 | 2.54 | 0.300 | 7.62 | 48 | 1219 |
| SG110180D | 0.110 | 2.79 | 0.180 | 4.57 | 48 | 1219 |
| SG120150D | 0.120 | 3.05 | 0.150 | 3.81 | 48 | 1219 |
| SG120250D | 0.120 | 3.05 | 0.250 | 6.35 | 48 | 1219 |
| SG120360D | 0.120 | 3.05 | 0.360 | 9.14 | 48 | 1219 |
| SG120475D | 0.120 | 3.05 | 0.475 | 12.06 | 48 | 1219 |
| SG125187D | 0.125 | 3.17 | 0.187 | 4.75 | 48 | 1219 |
| SG125250D | 0.125 | 3.17 | 0.250 | 6.35 | 48 | 1219 |
| SG130190D | 0.130 | 3.30 | 0.190 | 4.83 | 48 | 1219 |
| SG140250D | 0.140 | 3.56 | 0.250 | 6.35 | 48 | 1219 |
| SG150250D | 0.150 | 3.81 | 0.250 | 6.35 | 48 | 1219 |
| SG160240D | 0.160 | 4.06 | 0.240 | 6.10 | 48 | 1219 |
| SG180400D | 0.180 | 4.57 | 0.400 | 10.16 | 48 | 1219 |
| SG187250D | 0.187 | 4.75 | 0.250 | 6.35 | 48 | 1219 |
| SG195260D | 0.195 | 4.95 | 0.260 | 6.60 | 48 | 1219 |
| SG236236D | 0.236 | 5.99 | 0.236 | 5.99 | 48 | 1219 |
| SG250375D | 0.250 | 6.35 | 0.375 | 9.52 | 48 | 1219 |
| SG295355D | 0.295 | 7.49 | 0.355 | 9.02 | 48 | 1219 |
| SG315630D | 0.315 | 8.00 | 0.630 | 16.00 | 48 | 1219 |
| SG375500D | 0.375 | 9.52 | 0.500 | 12.70 | 48 | 1219 |
| SG430500D | 0.430 | 10.92 | 0.500 | 12.70 | 48 | 1219 |
| SG562709D | 0.562 | 14.27 | 0.709 | 18.00 | 48 | 1219 |
| SG670670D | 0.670 | 17.02 | 0.670 | 17.02 | 48 | 1219 |

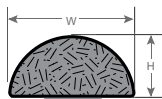

Black = inches
Blue = mm

| Oval Shape | | | | | | |
|-------------|--------|-------|--------|-------|----|------|
| PART NUMBER | HEIGHT | WIDTH | LENGTH | | | |
| SG140200E | 0.140 | 3.56 | 0.200 | 5.08 | 48 | 1219 |
| SG160790E | 0.160 | 4.06 | 0.790 | 20.07 | 48 | 1219 |

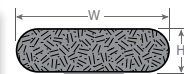

Black = inches
Blue = mm

| Triangle Shape | | | | | | |
|----------------|--------|-------|--------|-------|----|------|
| PART NUMBER | HEIGHT | WIDTH | LENGTH | | | |
| SG098500TR | 0.098 | 2.49 | 0.500 | 12.70 | 48 | 1219 |
| SG090394TR | 0.090 | 2.29 | 0.394 | 10.01 | 48 | 1219 |
| SG100400TR | 0.100 | 2.54 | 0.400 | 10.16 | 48 | 1219 |
| SG140390TR | 0.140 | 3.56 | 0.390 | 9.91 | 48 | 1219 |

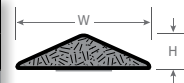

Black = inches
Blue = mm

| P-Shape | | | | | | |
|-------------|--------|-------|--------|-------|----|------|
| PART NUMBER | HEIGHT | WIDTH | LENGTH | | | |
| SG016195P | 0.016 | 0.41 | 0.195 | 4.95 | 48 | 1219 |
| SG060275P | 0.060 | 1.52 | 0.275 | 6.98 | 48 | 1219 |
| SG080200P | 0.080 | 2.03 | 0.200 | 5.08 | 48 | 1219 |
| SG125750P | 0.125 | 3.17 | 0.750 | 19.05 | 48 | 1219 |
| SG130520P | 0.130 | 3.30 | 0.520 | 13.20 | 48 | 1219 |
| SG145520P | 0.145 | 3.68 | 0.520 | 13.21 | 48 | 1219 |
| SG200395P | 0.200 | 5.08 | 0.395 | 10.03 | 48 | 1219 |



Black = inches
Blue = mm

Typical Performance

Shielding Effectiveness
80 - 115dB

Frequency Range
20Mhz - 10GHz

Dura-Layer Construction
Polyurethane foam core with high-performance fabric

Recommended Compression
30-50% of gasket height

| Typical Cross Section Tolerances | | | |
|--|-----------------|--------------------------|--------------------|
| ±.010 in. | (0.25 mm) | for all dimensions up to | 0.04 in. (1.02 mm) |
| ±.020 in. | (0.50 mm) | for all dimensions above | 0.04 in. (1.02 mm) |
| Detailed part drawings are available upon request. | | | |
| Typical Length Tolerances | | | |
| 0.20 to 6.00 in. | (5 - 152 mm) | ±.03 in. | (0.76 mm) |
| 6.01 to 18.00 in. | (153 - 457 mm) | ±.06 in. | (1.52 mm) |
| 18.01 to 48.00 in. | (458 - 1219 mm) | ±.08 in. | (2.03 mm) |

| Part Number Explanation | | | | |
|---|--------|-------|---------|-----------|
| SG | X X X | X X X | X | X X . X X |
| ↓ | ↓ | ↓ | ↓ | ↓ |
| #Start | Height | Width | Profile | Length |
| *Example: SG125250D-22.50: Gasket .125 tall, .250 wide, D-Shape and 22.5" long | | | | |

FSG FOR ELECTRONIC ENCLOSURES CONT.

D-SUB MINIATURE

very conformable to irregular surfaces.

- Eliminates any gap problem between connector and I/O surface plates. Compresses from .100" to .025" (2.5 to 0.6mm)
- Outside conductive surface is metalized CuNi fabric
- 9, 15, 25, 37 and 50 pin connector gaskets available in stock
- Available with adhesive tape. Please consult factory for ordering information
- Consult factory for custom profiles, thicknesses and sizes available
- For metal option - see page 22

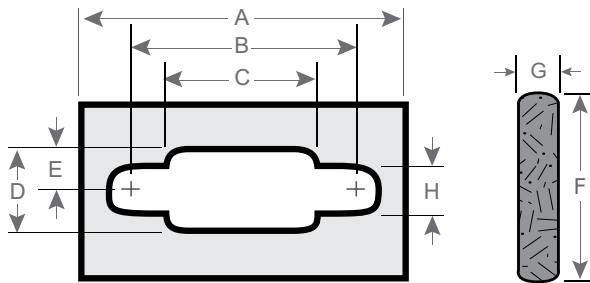

| D-Sub Miniature | | | | | | | | | | | | | | | | | |
|-----------------|--------|------|-------|------|-------|------|-------|------|-------|------|------|-----|-------|-----|------|------|------|
| PART NUMBER | TYPE | A | B | C | D | E | F | G | H | | | | | | | | |
| SG140009DS | 9 Pin | 1.40 | 35.56 | 0.98 | 24.89 | 0.78 | 19.81 | 0.44 | 11.18 | 0.22 | 5.59 | 0.7 | 17.78 | 0.1 | 2.54 | 0.15 | 3.81 |
| SG175015DS | 15 Pin | 1.75 | 44.45 | 1.31 | 33.27 | 1.11 | 28.19 | 0.44 | 11.18 | 0.22 | 5.59 | 0.7 | 17.78 | 0.1 | 2.54 | 0.15 | 3.81 |
| SG228025DS | 25 Pin | 2.28 | 57.91 | 1.85 | 46.99 | 1.65 | 41.91 | 0.44 | 11.18 | 0.22 | 5.59 | 0.7 | 17.78 | 0.1 | 2.54 | 0.15 | 3.81 |
| SG293037DS | 37 Pin | 2.93 | 74.42 | 2.50 | 63.54 | 2.29 | 58.17 | 0.44 | 11.18 | 0.22 | 5.59 | 0.7 | 17.78 | 0.1 | 2.54 | 0.15 | 3.81 |
| SG284050DS | 50 Pin | 2.84 | 72.14 | 2.41 | 61.21 | 2.20 | 55.88 | 0.55 | 13.97 | 0.28 | 7.11 | 0.8 | 20.32 | 0.1 | 2.54 | 0.15 | 3.81 |

Black = inches
Blue = mm

Typical Performance

Shielding Effectiveness
80 - 115dB

Frequency Range
20Mhz - 10GHz

Dura-Layer Construction
Polyurethane foam core with high-performance fabric

Recommended Compression
30-50% of gasket height

| Typical Cross Section Tolerances | | | |
|--|-----------------|--------------------------|--------------------|
| ±.010 in. | (0.25 mm) | for all dimensions up to | 0.04 in. (1.02 mm) |
| ±.020 in. | (0.50 mm) | for all dimensions above | 0.04 in. (1.02 mm) |
| Detailed part drawings are available upon request. | | | |
| Typical Length Tolerances | | | |
| 0.20 to 6.00 in. | (5 - 152 mm) | ±.03 in. | (0.76 mm) |
| 6.01 to 18.00 in. | (153 - 457 mm) | ±.06 in. | (1.52 mm) |
| 18.01 to 48.00 in. | (458 - 1219 mm) | ±.08 in. | (2.03 mm) |

SHIELDING FABRICS & CONDUCTIVE TAPES

Shielding Fabrics

Shielding effectiveness is determined by a combination of the reflection and absorption of RF signals. Absorption depends on the thickness of the shield material. However, reflection occurs at the shield surface and its effectiveness is independent of thickness. Reflection is the determining factor for all high frequency signal attenuation. (Note: When using these materials for conductive shielding gaskets, conductivity is the determinant.) Maximum reflection occurs with the highest conductivity materials – the best being copper, nickel and combinations of both.

Applications

Bonding or laminating to complex geometric shapes with optional hot melt or conductive adhesive.

- Large surface coverage with minimal seams due to 41" material width
- ESD/RFI-EMI shielding attenuation > 70dB up to 10 GHz for CuNi type
- Seal enclosure panels and frames, seams or joints
- Use for architectural shielding or shielded room wall and ceiling finishing

Options

- All materials are available in non-adhesive, hot melt or conductive adhesive backing
- Standard sheets are 41" x 36" (1041 x 914 mm)
- Longer lengths can be custom ordered – please consult factory for information
- Full rolls are 325' (99M) long – please consult factory for ordering information. Note: conductive adhesive versions are 164' (50M) long



| Shielding Fabrics | | | | | | | | | | | | | | |
|--------------------------|---------------------|-----------------------|-----------------------|-------|--------|-----------|---------------------|--------|--------|--------------|------|------|------|------|
| PART NUMBER W/O ADHESIVE | W/HOT MELT ADHESIVE | W/CONDUCTIVE ADHESIVE | DESCRIPTION | WIDTH | LENGTH | THICKNESS | SURFACE RESISTIVITY | 500KHZ | 100MHZ | 300MHZ | 1GHZ | | | |
| SF005PCN | SF005PCN-HM | SF005PCN-CA | Conductive CuNi Cloth | 41 | 1041 | 36 | 914 | 0.003 | 0.076 | .005 ohm/mm2 | 79dB | 81dB | 86dB | 82dB |
| SF030PCU | SF030PCU-HM | SF030PCU-CA | Conductive Cu Cloth | 41 | 1041 | 36 | 914 | 0.003 | 0.076 | .035 ohm/mm2 | 60dB | 67dB | 65dB | 62dB |
| SF050PNI | SF050PNI-HM | SF050PNI-CA | Conductive Ni Cloth | 41 | 1041 | 36 | 914 | 0.004 | 0.102 | .050 ohm/mm2 | 60dB | 72dB | 67dB | 63dB |

Black = inches
Blue = mm



Fabric Shielding Tapes

Applications

Cable shielding, enclosure seams, shielded room joints, PCB component shields, irregular surface/component shields, alternative to custom die-cut shielding gaskets or sections.

- Service Temperature: -40°F to 212°F (-40°C to 100°C)
- Adhesion: (peel) 50 oz/in. (54N/100mm)
- Material: CuNi metalized fabric and conductive acrylic adhesive backing w/release liner

| Fabric Shielding Tapes | | | | | | | | |
|------------------------|-------|-----------|--------|-------------|----------------|-------|-----------------------|-------------|
| PART NUMBER | WIDTH | THICKNESS | LENGTH | RESISTIVITY | IMPEDANCE | | | |
| ST005PCN25 | 0.25 | 6.35 | 0.005 | 0.13 | 85.0 ft. rolls | 25.0m | 0.03 - 0.05 ohms/inch | 69dB@100MHz |
| ST005PCN50 | 0.50 | 12.70 | 0.005 | 0.13 | 85.0 ft. rolls | 25.0m | 0.03 - 0.05 ohms/inch | 69dB@100MHz |
| ST005PCN75 | 0.75 | 19.05 | 0.005 | 0.13 | 85.0 ft. rolls | 25.0m | 0.03 - 0.05 ohms/inch | 69dB@100MHz |
| ST005PCN100 | 1.00 | 25.40 | 0.005 | 0.13 | 85.0 ft. rolls | 25.0m | 0.03 - 0.05 ohms/inch | 69dB@100MHz |
| ST005PCN200 | 2.00 | 50.80 | 0.005 | 0.13 | 85.0 ft. rolls | 25.0m | 0.03 - 0.05 ohms/inch | 69dB@100MHz |

Black = inches
Blue = mm

CFS CONDUCTIVE FOAM SHIELDING MATERIAL FOR DIE-CUT GASKETS

CFS Conductive Foam Shielding Material consists of resilient Nickel-Copper polyurethane foam which is layered between two pieces of conductive polyester fabric. This CFS Conductive Foam is ideal for applications that require low compression forces but excellent shielding effectiveness.

Performance

Operating Temperatures: -40F – +156F (-40C - +70C)

Surface Resistivity: <0.2 ohms/sq

Shielding Effectiveness: 60dB Typical 10MHz – 3GHz

Flammability: UL94-HBF Unless otherwise noted UL94-V1*

Typical Compression Load: 2.1 PSI at recommended 30% compression

Availability

Sheets: Up to 1.0m x 1.0m (*Custom Sizes Available*)

Finishing: Precision Die-Cut Forms & Shapes

Available with Conductive Adhesive

Material Characteristics

High Shielding Effectiveness

Low Compression

Low Surface Resistivity

Applications

Intricate die cuts forms

I/O panels

Backplanes

Connectors

Access panels



| CFS Conductive Foam Shielding Material | | |
|--|----------------|----------|
| PART NUMBER | STD SHEET SIZE | ADHESIVE |
| CFS1919060-NTP | 19 X 19 X .060 | NO |
| CFS1919060 | 19 X 19 X .060 | YES |
| CFS1919098-NTP | 19 X 19 X .098 | NO |
| CFS1919098 | 19 X 19 X .098 | YES |
| CFS1919138-NTP | 19 X 19 X .138 | NO |
| CFS1919138 | 19 X 19 X .138 | YES |
| CFS2222060-V1-NTP* | 22 X 22 X .060 | NO |
| CFS2222060 | 22 X 22 X .060 | YES |

*Other sizes available.
Consult Applications Engineering.

CUSTOM AND DIE-CUT SHIELDING GASKETS

In addition to our large assortment of stock products, Leader Tech offers customers the ability to create custom and die-cut shielding gaskets using any of our conductive elastomer formulations or fabric shielding gasket materials. Our extensive manufacturing capabilities include extrusion, molding and precision die-cut shapes and sizes.

All of our high-performance custom shielding gaskets can be made from your choice of twelve MIL-DTL-83528 Conductive Elastomer compounds or from our Fabric Shielding Gasket material. Depending on your unique application requirements, our engineering team will work to develop a custom gasketing solution that exhibits superior shielding properties and ensures a long performance life in a cost effective manner.

Please review your application with our Material Specialist and Engineering Group to determine the best materials to use for your application.

Die Cut Gasket Design Recommendations and Tolerances



NOTES:

1. Minimum recommended flange width (W) is .125".
2. Hole diameter (D) must exceed material thickness (T).
3. Distance edge of hole to edge of gasket (E) must exceed material thickness (T).
If not possible, then a slot is required.
4. Recommend assign datum to hole C/L and not to edge of gasket.

| Tolerance Range | | | | |
|-----------------|-------------|----------|-----------|------------|
| FEATURE TYPE | Sample Dim. | 0 - 4" | 4.1 - 12" | 12.1 - 24" |
| Length/Width | A, B, W | +/- .020 | +/- .030 | +/- .040 |
| Hole Location | C, F | +/- .010 | +/- .015 | +/- .020 |
| Hole Diameter | D | +/- .020 | +/- .030 | +/- .040 |

PRODUCTS AND LITERATURE

We've Got You Covered

Reliable Board, Enclosure and Cable Shielding Solutions

Leader Tech is a world-leading innovator and US-based manufacturer of EMI shielding products for circuit boards, enclosures and cables. In addition to our best selling standard, modified standard and custom CBS shields, Leader Tech offers an expansive line of beryllium copper fingerstock gaskets, conductive elastomers, advanced RF absorber materials and EMI/RFI ferrites.



CBS Circuit Board Shielding Catalog

FerriShield Ferrite Catalog

TechSIL Conductive Elastomer Catalog

EA EMI Microwave Absorbers Catalog

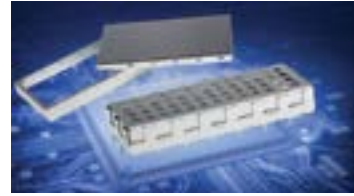

LeaderTech Shielding Products

Board Level Shielding

- Standard and Multi-Cavity CBS
- Modified Standard Options
- Custom Circuit Board Shields

FerriShield Ferrites

- Snap-On Bisected & Solid Bead Ferrites
- Round & Flat Styles for Cables, Wires and Flex Circuits
- Low, High, Microwave and Wideband Frequency-Specific Material

Enclosure Shielding

- BeCu Fingerstock Gaskets
- TechSIL 5000 Conductive Elastomers
- Conductive Fabric Shielding Gaskets
- TechSIL 8000 Oriented Wire Gaskets
- TechMESH Knitted Wire Gaskets
- TechMESH Combo Strip & Gaskets

**EMI
Problem?**

Our sales engineers are waiting for your call: 866-TECH-EMI (866-832-4364)

Visit our web site today to browse our complete product line, download literature and find your local sales engineer or sales representative!
www.leadertechinc.com