

**UXN40M7K**

**Datasheet**

**40 GHz Divide-by-1-to-127 Programmable  
Integer Divider**



**Microsemi Corporate Headquarters**

One Enterprise, Aliso Viejo,  
CA 92656 USA

Within the USA: +1 (800) 713-4113

Outside the USA: +1 (949) 380-6100

Fax: +1 (949) 215-4996

Email: [sales.support@microsemi.com](mailto:sales.support@microsemi.com)

[www.microsemi.com](http://www.microsemi.com)

©2020 Microsemi Corporation. All rights reserved. Microsemi and the Microsemi logo are registered trademarks of Microsemi Corporation. All other trademarks and service marks are the property of their respective owners.

Microsemi makes no warranty, representation, or guarantee regarding the information contained herein or the suitability of its products and services for any particular purpose, nor does Microsemi assume any liability whatsoever arising out of the application or use of any product or circuit. The products sold hereunder and any other products sold by Microsemi have been subject to limited testing and should not be used in conjunction with mission-critical equipment or applications. Any performance specifications are believed to be reliable but are not verified, and Buyer must conduct and complete all performance and other testing of the products, alone and together with, or installed in, any end-products. Buyer shall not rely on any data and performance specifications or parameters provided by Microsemi. It is the Buyer's responsibility to independently determine suitability of any products and to test and verify the same. The information provided by Microsemi hereunder is provided "as is, where is" and with all faults, and the entire risk associated with such information is entirely with the Buyer. Microsemi does not grant, explicitly or implicitly, to any party any patent rights, licenses, or any other IP rights, whether with regard to such information itself or anything described by such information. Information provided in this document is proprietary to Microsemi, and Microsemi reserves the right to make any changes to the information in this document or to any products and services at any time without notice.

**About Microsemi**

Microsemi Corporation (Nasdaq: MSCC) offers a comprehensive portfolio of semiconductor and system solutions for aerospace & defense, communications, data center and industrial markets. Products include high-performance and radiation-hardened analog mixed-signal integrated circuits, FPGAs, SoCs and ASICs; power management products; timing and synchronization devices and precise time solutions, setting the world's standard for time; voice processing devices; RF solutions; discrete components; enterprise storage and communication solutions; security technologies and scalable anti-tamper products; Ethernet solutions; Power-over-Ethernet ICs and midspans; as well as custom design capabilities and services. Microsemi is headquartered in Aliso Viejo, California, and has approximately 4,800 employees globally. Learn more at [www.microsemi.com](http://www.microsemi.com).

---

# 1 Revision History

---

The revision history describes the changes that were implemented in the document. The changes are listed by revision, starting with the most current publication.

## 1.1 Revision 1.0

Revision 1.0 was published in February 2017. It was the first publication of this document.

## 1.2 Revision 2.0

Revision 2.0 was published in April 2020. The Electrical Characteristics table was updated.

---

## Contents

---

<b>1</b>	<b>Revision History</b> .....	<b>3</b>
1.1	Revision 1.0.....	3
1.2	Revision 2.0.....	3
<b>2</b>	<b>Product Overview</b> .....	<b>7</b>
2.1	Applications .....	7
2.2	Key Features.....	7
<b>3</b>	<b>Electrical Specifications</b> .....	<b>8</b>
3.1	Electrical Characteristics.....	8
3.2	Functional Block Diagram .....	8
3.3	Pin Descriptions .....	8
3.4	CMOS Levels .....	9
3.5	Simplified Control Logic Schematic .....	9
3.6	Typical Performance Plots.....	10
<b>4</b>	<b>Pin Definition and Package Outline</b> .....	<b>12</b>
4.1	Pin Definition .....	12
4.2	Package Outline.....	13
<b>5</b>	<b>Application Notes</b> .....	<b>14</b>
5.1	Low-Frequency Operation .....	14
5.2	IC Assembly.....	14
5.3	ESD Sensitivity.....	14
5.4	Differential vs. Single-Ended .....	14
5.5	Duty Cycle.....	16
<b>6</b>	<b>Ordering Information</b> .....	<b>18</b>

## Figures

Figure 1	UXN40M7K Package Outline .....	7
Figure 2	Functional Block Diagram .....	8
Figure 3	Simplified Control Logic Schematic .....	9
Figure 4	Min/Max Single-Ended Input Power Input Sensitivity Window .....	10
Figure 5	Divide-by-8 Output Power, 3rd Harmonic, and Input Feed Through.....	10
Figure 6	Static Divide-by-80 Configuration .....	10
Figure 7	Static Divide-by-127 Configuration.....	10
Figure 8	Output Amplitude vs. Frequency .....	10
Figure 9	Fundamental Feed Through.....	10
Figure 10	Sensitivity Window vs. Supply Voltage .....	11
Figure 11	Sensitivity Window vs. Temperature.....	11
Figure 12	S-Parameters S11 .....	11
Figure 13	S-Parameters S12 .....	11
Figure 14	S-Parameters S21 .....	11
Figure 15	S-Parameters S22 .....	11
Figure 16	Package Outline.....	13
Figure 17	Bias Tee Circuit.....	15
Figure 18	Positive Supply (AC Coupling).....	15
Figure 19	Period–Pulse Width Relationship .....	16
Figure 20	Duty Cycle vs. Divide Ratio.....	17

---

## Tables

---

Table 1	Electrical Characteristics .....	8
Table 2	Pin Descriptions.....	8
Table 3	CMOS Levels for Control Lines R0-R8 .....	9
Table 4	CMOS Levels for Control Lines R0-R8 .....	9
Table 5	Pin Definitions .....	12
Table 6	Duty Cycle Summary.....	16
Table 7	Ordering Information.....	18

## 2 Product Overview

The UXN40M7K is a highly programmable integer divider covering all integer divide ratios between 1 and 127. The device features single-ended or differential inputs and outputs. Parallel control inputs are CMOS and LVTTTL compatible for ease of system integration. The UXN40M7K is packaged in a 24-pin, 4 mm × 4 mm leadless ceramic surface mount package, shown in the following figure (dimensions are in millimeters).

**Figure 1 UXN40M7K Package Outline**

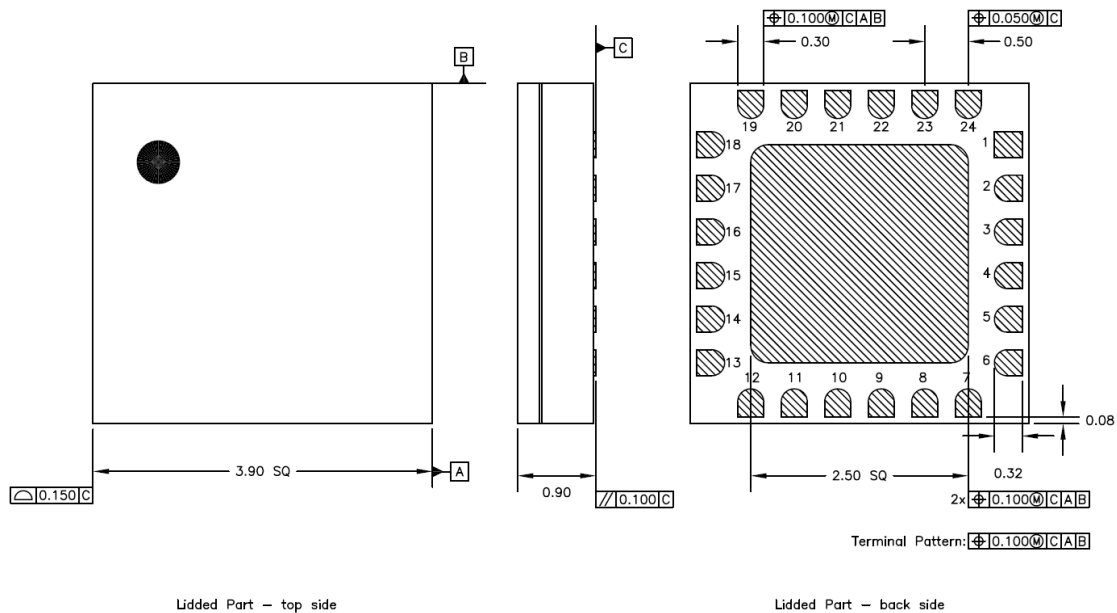

### 2.1 Applications

The UXN40M7K can be used as a general purpose, highly configurable divider in a variety of high-frequency synthesizer applications. Fast switching combined with a wide range of divide ratios make the UXN40M7K an excellent choice for fractional-N and integer-N phase-locked loops. Fractional division may be achieved by applying a sequence to the divider control lines, such as a delta-sigma modulated sequence.

### 2.2 Key Features

The following are the key features of the UXN40M7K device:

- Wide operating range: 0.5 GHz–40 GHz
- Contiguous divide ratios: 1 to 127
- Large output swings: >600 mVpp/side
- Single-ended and/or differential drive
- Small size: 4 mm × 4 mm
- Parallel control lines
- Low SSB phase noise: –153 dBc at 10 kHz offset

## 3 Electrical Specifications

This section details the electrical specifications of the UXN40M7K device.

### 3.1 Electrical Characteristics

The following table shows the electrical characteristics of the UXN40M7K device at 25 °C, where  $V_{CC} = 3.3\text{ V}$ ,  $I_{CC} = 230\text{ mA}$ , and  $Z_O = 50\ \Omega$ .

**Table 1 Electrical Characteristics**

Parameter	Description	Min	Typ	Max
$F_{IN}$ (GHz)	Input frequency	0.5		50
$P_{IN}$ (dBm)	Input power		0	10
$P_{OUT}$ (dBm)	Output power		2.00	
$P_{DC}$ (W)	DC power dissipation		0.75	
$\theta_{JC}$ (°C/W)	Junction-case thermal resistance		26	

### 3.2 Functional Block Diagram

The following drawing shows the functional blocks of the UXN40M7K device.

**Figure 2 Functional Block Diagram**

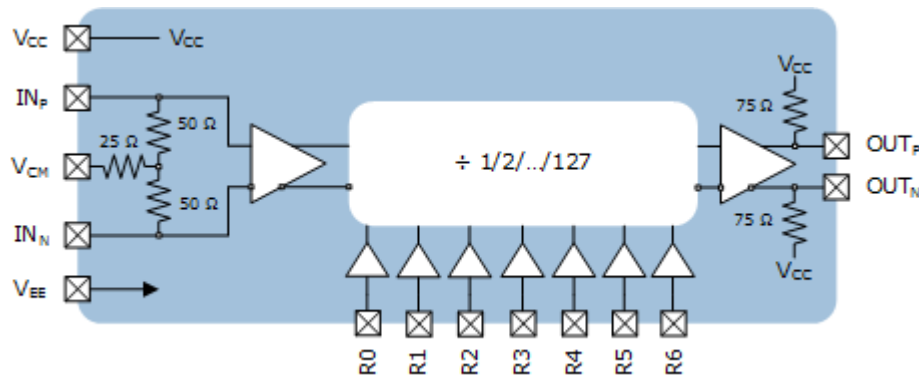

### 3.3 Pin Descriptions

The following table shows the pin descriptions of the UXN40M7K device.

**Table 2 Pin Descriptions**

Pin Name	Description	Notes
$IN_P^1$	Divider input, positive terminal	CML signal levels
$IN_N^1$	Divider input, negative terminal	CML signal levels
$OUT_P$	Divider output, positive terminal	CML signal levels
$OUT_N$	Divider output, positive terminal	CML signal levels



Pin Name	Description	Notes
R0–R6	Divider modulus control (R6 = MSB)	CMOS levels default to logic 0
V <sub>CC</sub>	3.3 V at 230 mA	Positive supply voltage
V <sub>EE</sub>	RC and DC ground	The paddle is floating
V <sub>CM</sub> <sup>1</sup>	Common mode input	

1. IN<sub>P</sub>, IN<sub>N</sub>, and V<sub>CM</sub> require coupling capacitors at the inputs, with V<sub>CM</sub>'s capacitor going to ground.

Use the following equation to find the divider modulus, where setting all bits to 0 results in N = 1.

$$\text{Divider Modulus} = N = P_0 \cdot 2^0 + P_1 \cdot 2^1 + P_2 \cdot 2^2 + \dots + P_6 \cdot 2^6 \text{ for } 1 \leq N \leq 127$$

### 3.4 CMOS Levels

The following table shows the CMOS levels for control lines R0-R8 of the UXN40M7K device.

**Table 3 CMOS Levels for Control Lines R0-R8**

Logic Level	Minimum	Typical
Supply voltage (V <sub>CC</sub> -V <sub>EE</sub> )	3.6	V
RF input power (IN <sub>P</sub> , IN <sub>N</sub> )	10	dBm
Operating temperature	-40 to 85	°C
Storage temperature	-85 to 125	°C
Junction temperature	125	°C

The following table shows the CMOS levels for control lines R0-R8 of the UXN40M7K device.

**Table 4 CMOS Levels for Control Lines R0-R8**

Logic State (P <sub>i</sub> )	Minimum	Typical	Maximum
1 (high)	V <sub>CC</sub> - 1.3 V	V <sub>CC</sub>	V <sub>CC</sub>
0 (low)	V <sub>EE</sub>	V <sub>EE</sub>	V <sub>EE</sub> + 0.8 V

### 3.5 Simplified Control Logic Schematic

The following drawing shows the simplified control logic schematic of the UXN40M7K device.

**Figure 3 Simplified Control Logic Schematic**

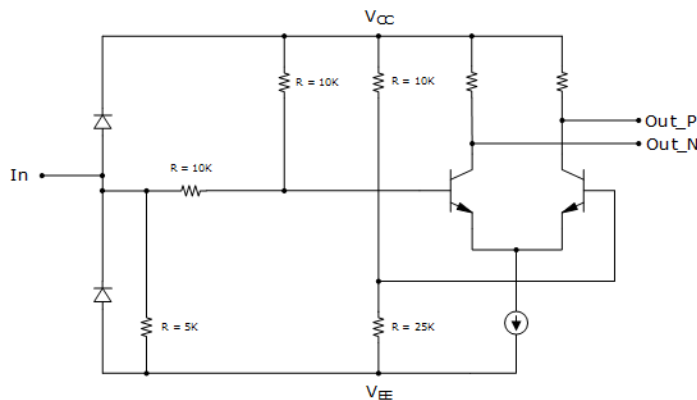

### 3.6 Typical Performance Plots

This section details the typical performance plots of the UXN40M7K device.

**Figure 4 Min/Max Single-Ended Input Power Input Sensitivity Window**

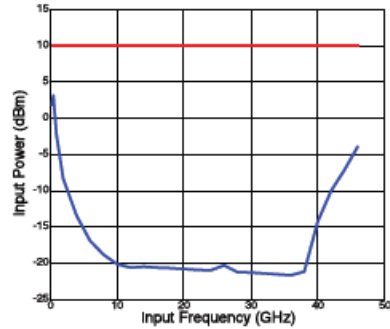

**Figure 5 Divide-by-8 Output Power, 3rd Harmonic, and Input Feed Through**

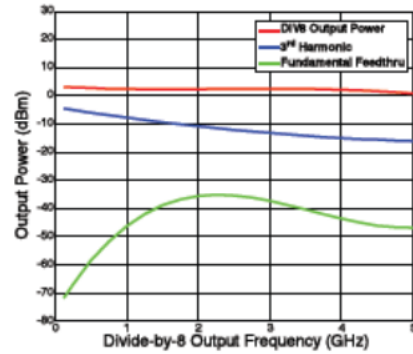

**Figure 6 Static Divide-by-80 Configuration**

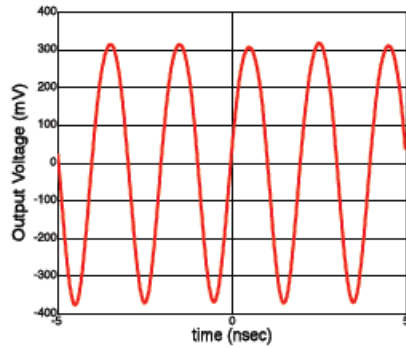

**Figure 7 Static Divide-by-127 Configuration**

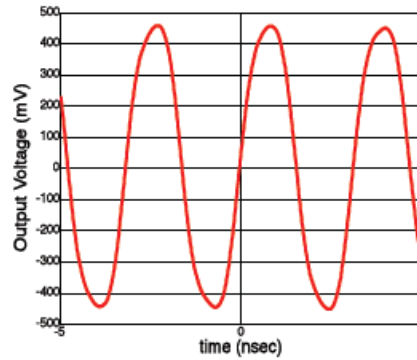

**Figure 8 Output Amplitude vs. Frequency**

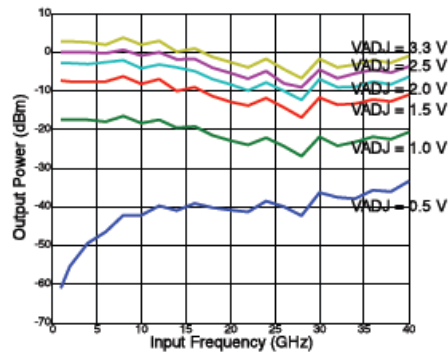

**Figure 9 Fundamental Feed Through**

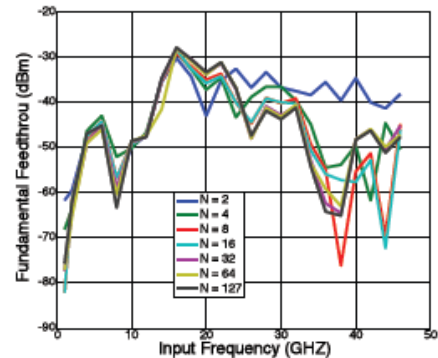

**Figure 10 Sensitivity Window vs. Supply Voltage**

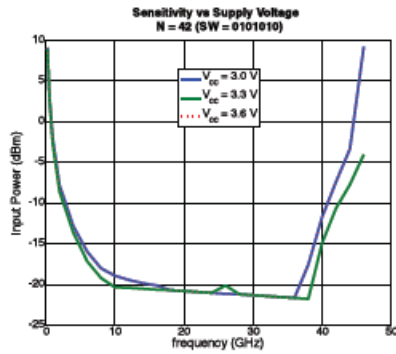

**Figure 11 Sensitivity Window vs. Temperature**

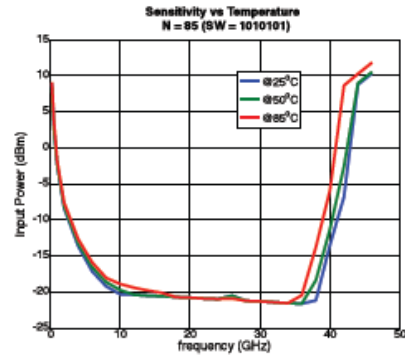

**Figure 12 S-Parameters S11**

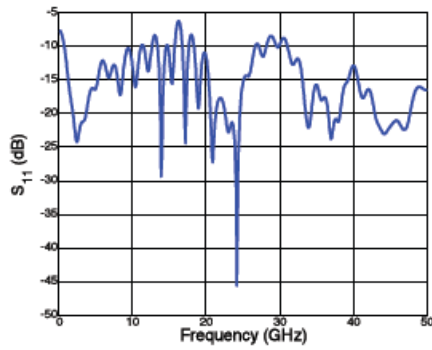

**Figure 13 S-Parameters S12**

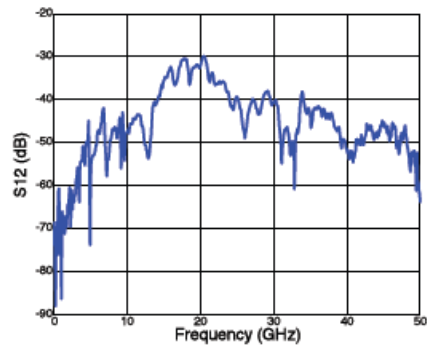

**Figure 14 S-Parameters S21**

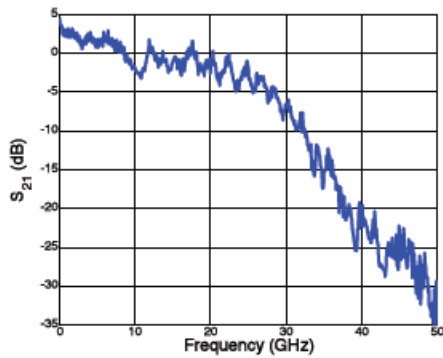

**Figure 15 S-Parameters S22**

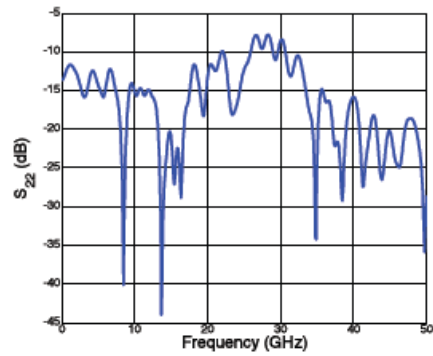

## 4 Pin Definition and Package Outline

The UXN40M7K is packaged in a 24-pin, 4 mm × 4 mm leadless ceramic surface mount package.

### 4.1 Pin Definition

The following table shows the pin definitions for the UXN40M7K device.

**Table 5 Pin Definitions**

Pin	Function	Notes
1 (R1)	Divide modulus control	Defaults to logic 0, connect to V <sub>CC</sub> for logic 1
2 (R0)	Divide modulus control (LSB)	Defaults to logic 0, connect to V <sub>CC</sub> for logic 1
3, 8, 9, 12, 17 (VEE)	RF and DC ground	0 V
4 (INP)	Divider input	Positive terminal of differential input
5 (INN)	Divider input	Negative terminal of differential input
6 (VCM)	Common mode input	Refer to functional block diagram
7, 10, 11, 13, 16, 19 (VCC)	Positive supply voltage	Nominally +3.3 V
14 (OUTP)	Divider output	Positive terminal of differential output
15 (OUTN)	Divider output	Negative terminal of differential output
18 (VADJ)	Output amplitude control	Tie to VCC for maximum swing
20 (R6)	Divide modulus control (MSB)	Defaults to logic 0, connect to V <sub>CC</sub> for logic 1
21 (R5)	Divide modulus control	Defaults to logic 0, connect to V <sub>CC</sub> for logic 1
22 (R4)	Divide modulus control	Defaults to logic 0, connect to V <sub>CC</sub> for logic 1
23 (R3)	Divide modulus control	Defaults to logic 0, connect to V <sub>CC</sub> for logic 1
24 (R2)	Divide modulus control	Defaults to logic 0, connect to V <sub>CC</sub> for logic 1
Paddle	Package paddle	Tie to heat sink



## 5 Application Notes

### 5.1 Low-Frequency Operation

Low-frequency operation is limited by external coupling capacitors and the slew rate of the input clock. The next paragraph shows the calculations for the capacitors. Sine-wave inputs are limited to roughly 500 MHz.

The values of the coupling capacitors for the high-speed inputs and outputs (I/Os) are determined by the lowest IC operation frequency.

$$C \gg \frac{1}{2 \cdot \pi \cdot 50 \Omega \cdot f_{lowest}}$$

For example, to use the device below 1 GHz, coupling capacitors should be larger than 3 pF.

### 5.2 IC Assembly

The device is designed to operate with either single-ended or differential inputs. The supply should be capacitively bypassed to ground to provide a good AC ground over the frequency range of interest. RF I/Os should be AC-coupled through the series capacitors. The backside of the chip should be connected to a good thermal heat sink.

### 5.3 ESD Sensitivity

Although SiGe ICs have robust ESD sensitivities, preventative ESD measures should be taken while storing, handling, and assembling.

Inputs are more ESD susceptible because they could expose the base of a BJT. All control inputs are protected with ESD diodes. These inputs should withstand voltage spikes up to 400 V.

### 5.4 Differential vs. Single-Ended

The UXN40M7K is fully differential to maximize signal-to-noise ratios for high-speed operation. The high-speed outputs are terminated to  $V_{CC}$  with on-chip 75  $\Omega$  resistors. The maximum DC voltage on either of the output terminals must be limited to  $V_{CC} \pm 1$  V to prevent damaging the termination resistors with excessive current.

The outputs require a DC return path capable of handling approximately 24 mA per side with  $V_{ADJ}$  set to  $V_{CC}$ . With AC coupling on the output, a bias tee circuit (for example, see [Figure 17](#)) is recommended for the fastest operation with maximum swing. The value of the capacitor should be large enough to pass the lowest frequencies of interest. The discrete R/L/C elements should be resonance free up to the maximum frequency of operation for broadband applications.



## 5.5 Duty Cycle

The UXN40M7K output duty cycle varies between 33% and 66% as a function of the divide ratio, N. When N is a power of 2, the duty cycle is exactly 50%. As N deviates from a power of 2, so too does the duty cycle deviate from 50%. For example, N = 64 has 50% duty cycle, N = 60 has 47% duty cycle, and N = 56 has 43% duty cycle.

The following equations calculate pulse width and duty cycle as a function of N, for any integer N from 2 to 127.

$$\text{Pulse width (input cycles)} = N - 2^{\text{floor}[\log_2(\frac{N}{3})+1]}$$

$$\text{Duty cycle (1\%)} = \frac{\text{Pulse width}}{\text{Divide ratio}} \times 100\%$$

The following illustration shows the period–pulse width relationship for the UXN40M7K device.

**Figure 19 Period–Pulse Width Relationship**

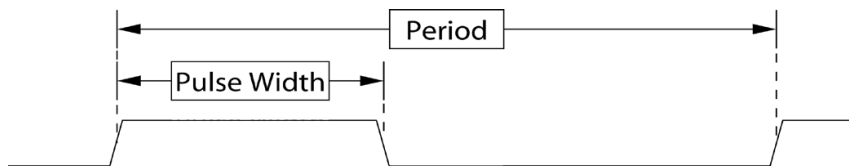

The following table shows the pulse width and duty cycle for N from 2 to 16 for the UXN40M7K device.

**Table 6 Duty Cycle Summary**

Divide Ratio	Pulse Width (Input Cycles)	Duty Cycle (%)
2	1	50
3	1	33
4	2	50
5	3	60
6	2	33
7	3	43
8	4	50
9	5	55
10	6	60
11	7	63
12	4	33
13	5	38
14	6	43
15	7	47
16	8	50



The following graph shows the duty cycle versus divide ratio for N = 1 to 127 for the UXN40M7K device.

**Figure 20 Duty Cycle vs. Divide Ratio**

