

HMOV™ Varistor Series



Description



The HMOV™ Varistor Series is specifically designed for applications requiring high surge energy absorption and high operating temperature of 125°C.

The maximum peak surge current is rated up to 10kA (8/20µs pulse) to protect against indirect lightning strikes, switching surge transients, and abnormally fast transients.

Features

- High operating temperature combined with high isolation voltage capability: 125°C and 2500V, respectively
- High surge current withstanding capability up to 10kA (8/20µs pulse)
- Complies with 1000 cycle, -55°C to 125°C, Thermal Shock Cycling Test
- Wide operating voltage range
- Three disc sizes available: 10mm, 14mm, and 20mm
- Lead-free, Halogen-free, and RoHS compliant

Agency Approvals

| Agency | Agency Approval | Agency File Number |
|--|--|-------------------------------|
|  | UL1449 | E320116 |
|  | IEC 60950-1(Annex Q) IECQ CS 042200 GB 0001 | IECQ-C BSI 15.0013 E1291/F |

Additional Information



Datashheet



Resources



Samples

Applications

- LED lighting
- Security System (fire alarm or smoke detector)
- Solar Power Inverter
- Automation control
- Power Supply Unit (outdoor and industrial)

Absolute Maximum Ratings

• See Device Ratings and Specifications chart for ratings of individual members of a series.

| | Low Voltage Series | Units |
|--|--------------------|-------|
| Continuous: | | |
| Steady State Applied Voltage: | | |
| AC Voltage Range (V_{MACRMS}) | 11 to 625 | V |
| DC Voltage Range (V_{MDC}) | 14 to 825 | V |
| Transient: | | |
| Non-Repetitive Surge Current, 8/20µs Waveform (I_{TM}) | 800 to 10,000 | A |
| Non-Repetitive Energy Capability, 2ms Waveform (W_{TM}) | 0.8 to 150 | J |
| Operating Ambient Temperature Range (T_A) | -55 to +125 | °C |
| Storage Temperature Range (T_{STG}) | -55 to +150 | °C |
| Temperature Coefficient (αV) of Clamping Voltage (V_C) at Specified Test Current | < 0.01% | °C |
| Hi-Pot Encapsulation (Isolation Voltage Capability) | 2500 | V |
| Silicone Coating Insulation Resistance | >1,000 | MΩ |

CAUTION: Stresses above those listed in "Absolute Maximum Ratings" may cause permanent damage to the device. This is a stress only rating and operation of the device at these or any other conditions above those indicated in the operational sections of this specification is not implied.

HMOV[™] Series Device Ratings and Specifications

| Silicone Coated Models | | Size Disc Dia. (mm) | Maximum Rating (125°C) | | | | | Specifications (25°C) | | | | |
|-------------------------|----------|---------------------|------------------------|--------------------|---------------------------|----------------------------|------------------------------|-------------------------|----------------------|-------------------------------------|-----------------|------------------------------|
| | | | Max Continuous Voltage | | Max Peak Current (8/20µs) | | Energy Rating (2ms, 1 pulse) | Varistor Voltage at 1mA | | Maximum Clamping Voltage (8 x 20µs) | | Typical Capacitance f = 1MHz |
| | | | V _{M(AC) RMS} | V _{M(DC)} | I _{TM} 1 x Pulse | I _{TM} 2 x Pulses | W _{TM} | V _{NOM} Min | V _{NOM} Max | V _C | I _{PK} | C |
| Part Number (Base part) | Branding | | (V) | (V) | (A) | (A) | (J) | (V) | (V) | (V) | (A) | (pF) |
| V10H11P | P10H11 | 10 | 11 | 14 | 1500 | 800 | 4.2 | 16.2 | 19.8 | 36 | 5 | 5450 |
| V14H11P | P14H11 | 14 | 11 | 14 | 3000 | 1800 | 8 | 16.2 | 19.8 | 36 | 10 | 12000 |
| V20H11P | P20H11 | 20 | 11 | 14 | 5000 | 3000 | 25 | 16.2 | 19.8 | 36 | 20 | 26000 |
| V10H14P | P10H14 | 10 | 14 | 18 | 1500 | 800 | 5 | 19.8 | 24.2 | 43 | 5 | 4650 |
| V14H14P | P14H14 | 14 | 14 | 18 | 3000 | 1800 | 10 | 19.8 | 24.2 | 43 | 10 | 10200 |
| V20H14P | P20H14 | 20 | 14 | 18 | 5000 | 3000 | 28 | 19.8 | 24.2 | 43 | 20 | 22200 |
| V10H17P | P10H17 | 10 | 17 | 22 | 1500 | 800 | 6.5 | 24.3 | 29.7 | 53 | 5 | 3900 |
| V14H17P | P14H17 | 14 | 17 | 22 | 3000 | 1800 | 13 | 24.3 | 29.7 | 53 | 10 | 8700 |
| V20H17P | P20H17 | 20 | 17 | 22 | 5000 | 3000 | 35 | 24.3 | 29.7 | 53 | 20 | 18750 |
| V10H20P | P10H20 | 10 | 20 | 26 | 1500 | 800 | 10 | 29.7 | 36.3 | 65 | 5 | 3400 |
| V14H20P | P14H20 | 14 | 20 | 26 | 3000 | 1800 | 20 | 29.7 | 36.3 | 65 | 10 | 7500 |
| V20H20P | P20H20 | 20 | 20 | 26 | 5000 | 3000 | 58 | 29.7 | 36.3 | 65 | 20 | 15000 |
| V10H23P | P10H23 | 10 | 23 | 28 | 1500 | 800 | 12 | 32.4 | 39.6 | 71 | 5 | 3200 |
| V14H23P | P14H23 | 14 | 23 | 28 | 3000 | 1800 | 23 | 32.4 | 39.6 | 71 | 10 | 7000 |
| V20H23P | P20H23 | 20 | 23 | 28 | 5000 | 3000 | 70 | 32.4 | 39.6 | 71 | 20 | 14000 |
| V10H25P | P10H25 | 10 | 25 | 31 | 1500 | 800 | 13 | 35.1 | 42.9 | 77 | 5 | 2900 |
| V14H25P | P14H25 | 14 | 25 | 31 | 3000 | 1800 | 25 | 35.1 | 42.9 | 77 | 10 | 6200 |
| V20H25P | P20H25 | 20 | 25 | 31 | 5000 | 3000 | 77 | 35.1 | 42.9 | 77 | 20 | 13500 |
| V10H30P | P10H30 | 10 | 30 | 38 | 1500 | 800 | 15.5 | 42.3 | 51.7 | 93 | 5 | 2550 |
| V14H30P | P14H30 | 14 | 30 | 38 | 3000 | 1800 | 32 | 42.3 | 51.7 | 93 | 10 | 5550 |
| V20H30P | P20H30 | 20 | 30 | 38 | 5000 | 3000 | 90 | 42.3 | 51.7 | 93 | 20 | 12000 |
| V10H35P | P10H35 | 10 | 35 | 45 | 1500 | 800 | 20 | 50.4 | 61.6 | 110 | 5 | 2200 |
| V14H35P | P14H35 | 14 | 35 | 45 | 3000 | 1800 | 40 | 50.4 | 61.6 | 110 | 10 | 5000 |
| V20H35P | P20H35 | 20 | 35 | 45 | 5000 | 3000 | 115 | 50.4 | 61.6 | 110 | 20 | 10500 |
| V10H40P | P10H40 | 10 | 40 | 56 | 1500 | 800 | 25 | 61.2 | 74.8 | 135 | 5 | 1850 |
| V14H40P | P14H40 | 14 | 40 | 56 | 3000 | 1800 | 50 | 61.2 | 74.8 | 135 | 10 | 4000 |
| V20H40P | P20H40 | 20 | 40 | 56 | 5000 | 3000 | 140 | 61.2 | 74.8 | 135 | 20 | 8500 |
| V10H50P | P10H50 | 10 | 50 | 65 | 3500 | 3000 | 20 | 73.8 | 90.2 | 135 | 25 | 1400 |
| V14H50P | P14H50 | 14 | 50 | 65 | 6500 | 5000 | 40 | 73.8 | 90.2 | 145 | 50 | 3000 |
| V20H50P | P20H50 | 20 | 50 | 65 | 10000 | 7000 | 80 | 73.8 | 90.2 | 145 | 100 | 6000 |
| V10H60P | P10H60 | 10 | 60 | 85 | 3500 | 3000 | 24 | 90 | 110 | 165 | 25 | 1200 |
| V14H60P | P14H60 | 14 | 60 | 85 | 6500 | 5000 | 50 | 90 | 110 | 175 | 50 | 2500 |
| V20H60P | P20H60 | 20 | 60 | 85 | 10000 | 7000 | 100 | 90 | 110 | 175 | 100 | 5200 |
| V10H75P | P10H75 | 10 | 75 | 100 | 3500 | 3000 | 29 | 108 | 132 | 200 | 25 | 1100 |
| V14H75P | P14H75 | 14 | 75 | 100 | 6500 | 5000 | 60 | 108 | 132 | 210 | 50 | 2300 |
| V20H75P | P20H75 | 20 | 75 | 100 | 10000 | 7000 | 120 | 108 | 132 | 210 | 100 | 4800 |
| V10H95P | P10H95 | 10 | 95 | 125 | 3500 | 3000 | 36 | 135 | 165 | 250 | 25 | 800 |
| V14H95P | P14H95 | 14 | 95 | 125 | 6500 | 5000 | 75 | 135 | 165 | 250 | 50 | 1700 |
| V20H95P | P20H95 | 20 | 95 | 125 | 10000 | 7000 | 150 | 135 | 165 | 250 | 100 | 3700 |
| V10H115P | P10H115 | 10 | 115 | 153 | 3500 | 3000 | 30 | 162 | 198 | 300 | 25 | 465 |
| V14H115P | P14H115 | 14 | 115 | 153 | 6500 | 5000 | 50 | 162 | 198 | 300 | 50 | 1190 |
| V20H115P | P20H115 | 20 | 115 | 153 | 10000 | 7000 | 120 | 162 | 198 | 300 | 100 | 2400 |
| V10H130P | P10H130 | 10 | 130 | 170 | 3500 | 3000 | 40 | 184.5 | 225.5 | 340 | 25 | 450 |
| V14H130P | P14H130 | 14 | 130 | 170 | 6500 | 5000 | 60 | 184.5 | 225.5 | 340 | 50 | 1000 |
| V20H130P | P20H130 | 20 | 130 | 170 | 10000 | 7000 | 145 | 184.5 | 225.5 | 340 | 100 | 1900 |
| V10H140P | P10H140 | 10 | 140 | 180 | 3500 | 3000 | 45 | 198 | 242 | 360 | 25 | 400 |

Note: 1. Average power dissipation of transients not to exceed 0.4W, 0.6W or 1W for model sizes 10mm, 14mm, and 20mm, respectively.

HMOV™ Series Device Ratings and Specifications

| | | Maximum Rating (125°C) | | | | | | Specifications (25°C) | | | | |
|-------------------------|----------|------------------------|------------------------|-------------|--------------------------------|---------------------------------|------------------------------|-------------------------|-----------------------|-------------------------------------|----------|------------------------------|
| | | Size Disc Dia. (mm) | Max Continuous Voltage | | Max Peak Current (8/20µs) | | Energy Rating (2ms, 1 pulse) | Varistor Voltage at 1mA | | Maximum Clamping Voltage (8 x 20µs) | | Typical Capacitance f = 1MHz |
| Part Number (Base part) | Branding | | $V_{M(AC) RMS}$ | $V_{M(DC)}$ | $I_{TM} 1 \times \text{Pulse}$ | $I_{TM} 2 \times \text{Pulses}$ | W_{TM} | $V_{NOM} \text{ Min}$ | $V_{NOM} \text{ Max}$ | V_C | I_{PK} | C |
| | | | (V) | (V) | (A) | (A) | (J) | (V) | (V) | (V) | (A) | (pF) |
| V14H140P | P14H140 | 14 | 140 | 180 | 6500 | 5000 | 65 | 198 | 242 | 360 | 50 | 900 |
| V20H140P | P20H140 | 20 | 140 | 180 | 10000 | 7000 | 155 | 198 | 242 | 360 | 100 | 1750 |
| V10H150P | P10H150 | 10 | 150 | 200 | 3500 | 3000 | 50 | 216 | 264 | 395 | 25 | 360 |
| V14H150P | P14H150 | 14 | 150 | 200 | 6500 | 5000 | 70 | 216 | 264 | 395 | 50 | 800 |
| V20H150P | P20H150 | 20 | 150 | 200 | 10000 | 7000 | 165 | 216 | 264 | 395 | 100 | 1600 |
| V10H175P | P10H175 | 10 | 175 | 225 | 3500 | 3000 | 55 | 243 | 297 | 455 | 25 | 350 |
| V14H175P | P14H175 | 14 | 175 | 225 | 6500 | 5000 | 80 | 243 | 297 | 455 | 50 | 700 |
| V20H175P | P20H175 | 20 | 175 | 225 | 10000 | 7000 | 180 | 243 | 297 | 455 | 100 | 1400 |
| V10H230P | P10H230 | 10 | 230 | 300 | 3500 | 3000 | 60 | 324 | 396 | 595 | 25 | 250 |
| V14H230P | P14H230 | 14 | 230 | 300 | 6500 | 5000 | 105 | 324 | 396 | 595 | 50 | 550 |
| V20H230P | P20H230 | 20 | 230 | 300 | 10000 | 7000 | 225 | 324 | 396 | 595 | 100 | 1100 |
| V10H250P | P10H250 | 10 | 250 | 320 | 3500 | 3000 | 65 | 351 | 429 | 650 | 25 | 220 |
| V14H250P | P14H250 | 14 | 250 | 320 | 6500 | 5000 | 115 | 351 | 429 | 650 | 50 | 500 |
| V20H250P | P20H250 | 20 | 250 | 320 | 10000 | 7000 | 240 | 351 | 429 | 650 | 100 | 1000 |
| V10H275P | P10H275 | 10 | 275 | 350 | 3500 | 3000 | 70 | 387 | 473 | 710 | 25 | 200 |
| V14H275P | P14H275 | 14 | 275 | 350 | 6500 | 5000 | 130 | 387 | 473 | 710 | 50 | 450 |
| V20H275P | P20H275 | 20 | 275 | 350 | 10000 | 7000 | 260 | 387 | 473 | 710 | 100 | 900 |
| V10H300P | P10H300 | 10 | 300 | 385 | 3500 | 3000 | 75 | 423 | 517 | 775 | 25 | 180 |
| V14H300P | P14H300 | 14 | 300 | 385 | 6500 | 5000 | 140 | 423 | 517 | 775 | 50 | 400 |
| V20H300P | P20H300 | 20 | 300 | 385 | 10000 | 7000 | 290 | 423 | 517 | 775 | 100 | 800 |
| V10H320P | P10H320 | 10 | 320 | 420 | 3500 | 3000 | 80 | 459 | 561 | 840 | 25 | 170 |
| V14H320P | P14H320 | 14 | 320 | 420 | 6500 | 5000 | 150 | 459 | 561 | 840 | 50 | 380 |
| V20H320P | P20H320 | 20 | 320 | 420 | 10000 | 7000 | 320 | 459 | 561 | 840 | 100 | 750 |
| V10H385P | P10H385 | 10 | 385 | 505 | 3500 | 3000 | 85 | 558 | 682 | 1025 | 25 | 160 |
| V14H385P | P14H385 | 14 | 385 | 505 | 6500 | 5000 | 175 | 558 | 682 | 1025 | 50 | 360 |
| V20H385P | P20H385 | 20 | 385 | 505 | 10000 | 7000 | 325 | 558 | 682 | 1025 | 100 | 700 |
| V10H420P | P10H420 | 10 | 420 | 560 | 3500 | 3000 | 90 | 612 | 748 | 1120 | 25 | 140 |
| V14H420P | P14H420 | 14 | 420 | 560 | 6500 | 5000 | 185 | 612 | 748 | 1120 | 50 | 300 |
| V20H420P | P20H420 | 20 | 420 | 560 | 10000 | 7000 | 330 | 612 | 748 | 1120 | 100 | 600 |
| V10H440P | P10H440 | 10 | 440 | 585 | 3500 | 3000 | 95 | 643.5 | 786.5 | 1180 | 25 | 130 |
| V14H440P | P14H440 | 14 | 440 | 585 | 6500 | 5000 | 185 | 643.5 | 786.5 | 1180 | 50 | 260 |
| V20H440P | P20H440 | 20 | 440 | 585 | 10000 | 7000 | 340 | 643.5 | 786.5 | 1180 | 100 | 500 |
| V10H460P | P10H460 | 10 | 460 | 615 | 3500 | 3000 | 95 | 675 | 825 | 1240 | 25 | 120 |
| V14H460P | P14H460 | 14 | 460 | 615 | 6500 | 5000 | 190 | 675 | 825 | 1240 | 50 | 220 |
| V20H460P | P20H460 | 20 | 460 | 615 | 10000 | 7000 | 370 | 675 | 825 | 1240 | 100 | 400 |
| V10H510P | P10H510 | 10 | 510 | 670 | 3500 | 3000 | 98 | 738 | 902 | 1355 | 25 | 110 |
| V14H510P | P14H510 | 14 | 510 | 670 | 6500 | 5000 | 205 | 738 | 902 | 1355 | 50 | 200 |
| V20H510P | P20H510 | 20 | 510 | 670 | 10000 | 7000 | 410 | 738 | 902 | 1355 | 100 | 350 |
| V10H550P | P10H550 | 10 | 550 | 745 | 3500 | 3000 | 98 | 819 | 1001 | 1500 | 25 | 100 |
| V14H550P | P14H550 | 14 | 550 | 745 | 6500 | 5000 | 210 | 819 | 1001 | 1500 | 50 | 180 |
| V20H550P | P20H550 | 20 | 550 | 745 | 10000 | 7000 | 450 | 819 | 1001 | 1500 | 100 | 300 |
| V10H625P | P10H625 | 10 | 625 | 825 | 3500 | 3000 | 110 | 900 | 1100 | 1650 | 25 | 90 |
| V14H625P | P14H625 | 14 | 625 | 825 | 6500 | 5000 | 235 | 900 | 1100 | 1650 | 50 | 160 |
| V20H625P | P20H625 | 20 | 625 | 825 | 10000 | 7000 | 490 | 900 | 1100 | 1650 | 100 | 250 |

Note: 1. Average power dissipation of transients not to exceed 0.4W, 0.6W or 1W for model sizes 10mm, 14mm, and 20mm respectively..

Current Energy and Power Dissipation Ratings

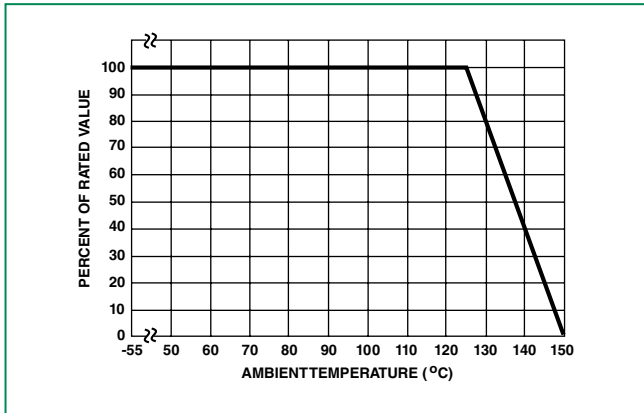

Note:
 The peak surge current and energy ratings must be reduced for applications exceeding 125°C ambient temperature.

Peak Pulse Current Test Waveform for Clamping Voltage

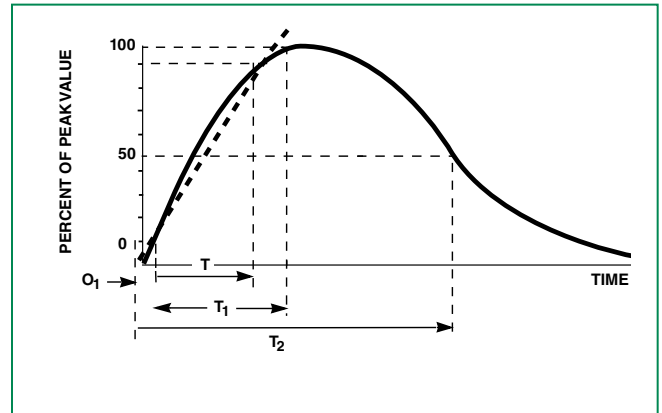

O_1 = Virtual Origin of Wave
 T = Time from 10% to 90% of Peak
 T_1 = Rise Time = $1.25 \times T$
 T_2 = Decay Time
Example - For an 8/20µs Current Waveform:
 $8\mu s = T_1$ = Rise Time
 $20\mu s = T_2$ = Decay Time

Maximum Clamping Voltage for 10mm Parts

V10x11P - V10x40P

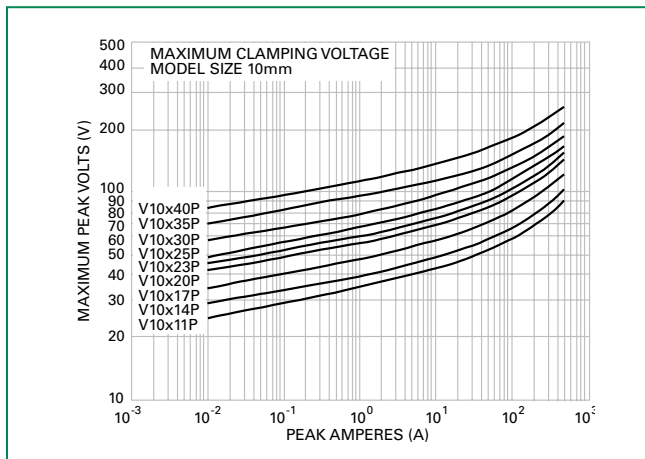

Maximum Clamping Voltage for 20mm Parts

V20x11P - V20x40P

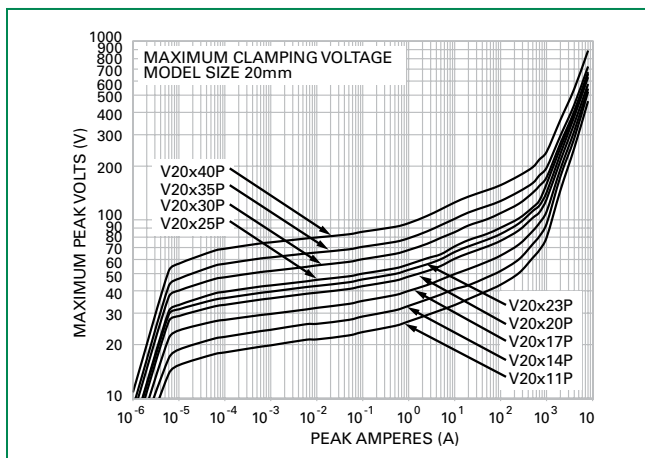

Maximum Clamping Voltage for 14mm Parts

V14x11P - V14x40P

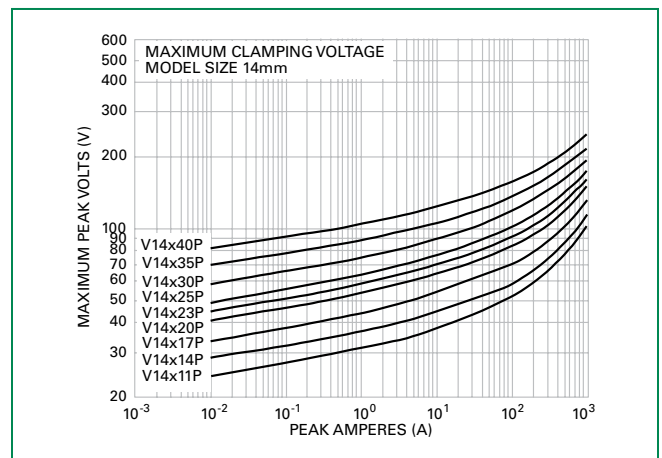

Maximum Clamping Voltage for 10mm Parts

V10x50P - V10x115P

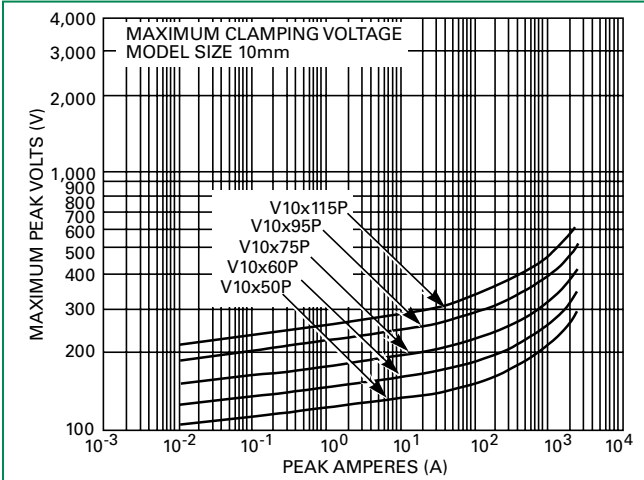

Maximum Clamping Voltage for 10mm Parts

V10x130P - V10x625P

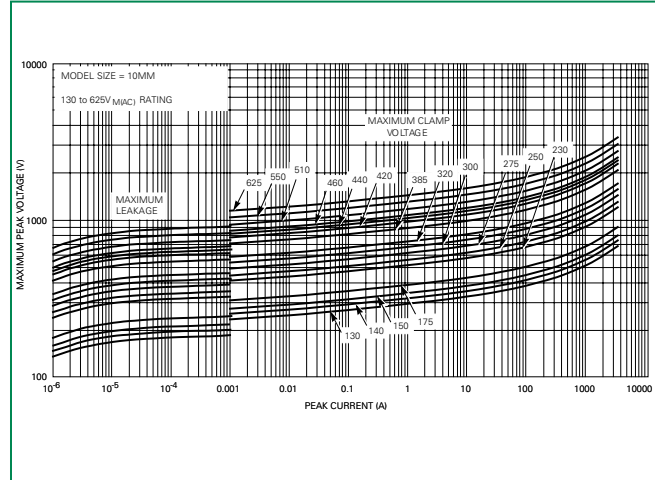

Maximum Clamping Voltage for 20mm Parts

V20x50P - V20x115P

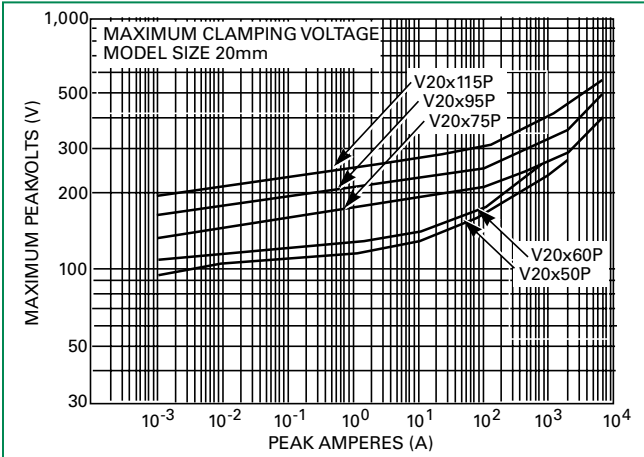

Maximum Clamping Voltage for 14mm Parts

V14x50P - V14x115P

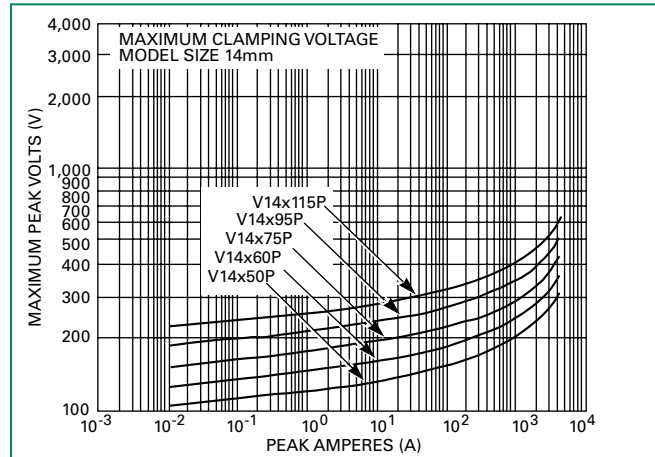

Maximum Clamping Voltage for 14mm Parts

V14x130P - V14x625P

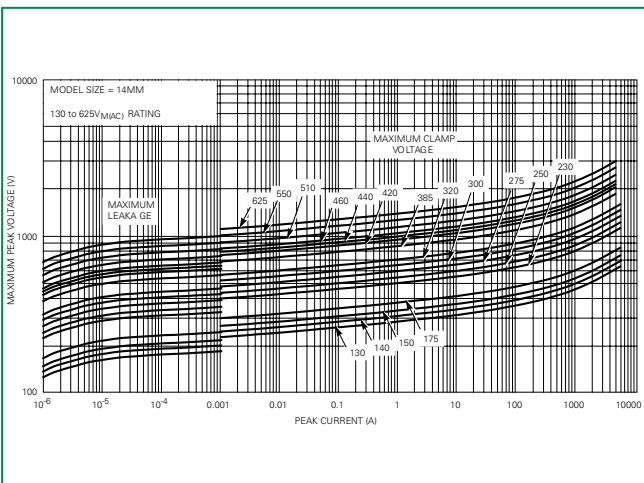

Maximum Clamping Voltage for 20mm Parts

V20x130P - V20x625P

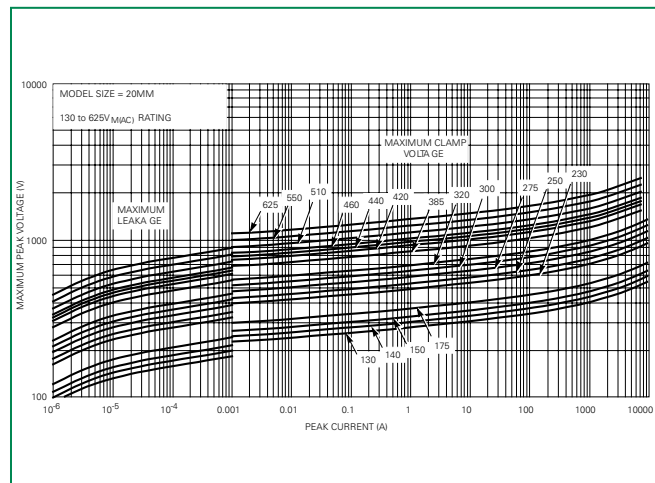

Repetitive Surge Capability for 10mm Parts

V10x11P - V10x40P

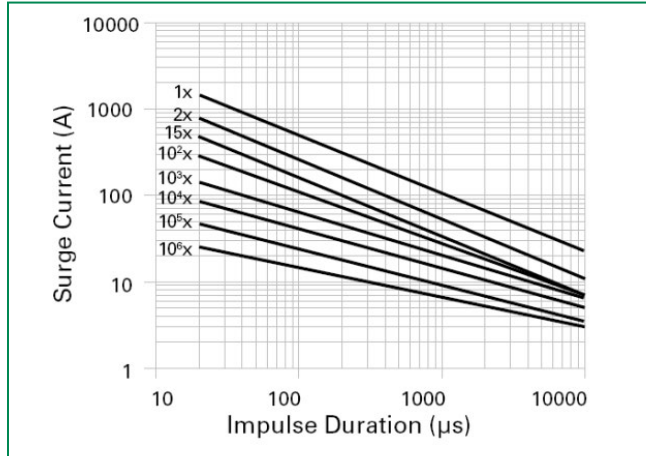

Repetitive Surge Capability for 14mm Parts

V14x11P - V14x40P

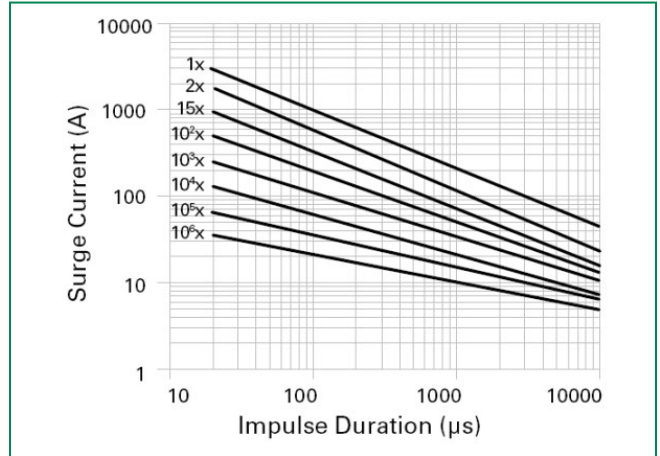

Repetitive Surge Capability for 20mm Parts

V20x11P - V20x40P

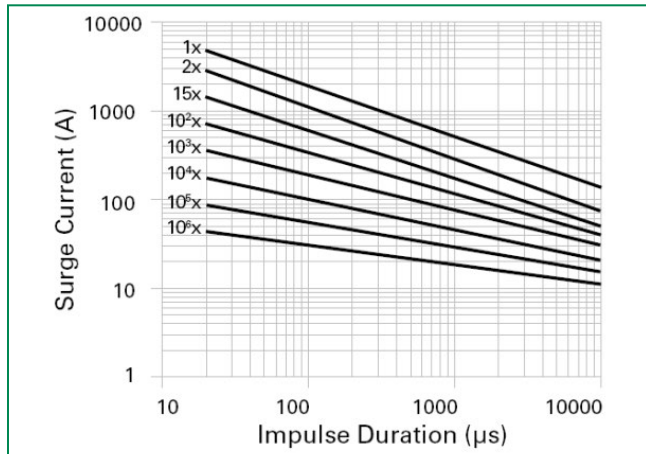

Maximum Clamping Voltage 10mm Parts

V10x115P - V10x625P

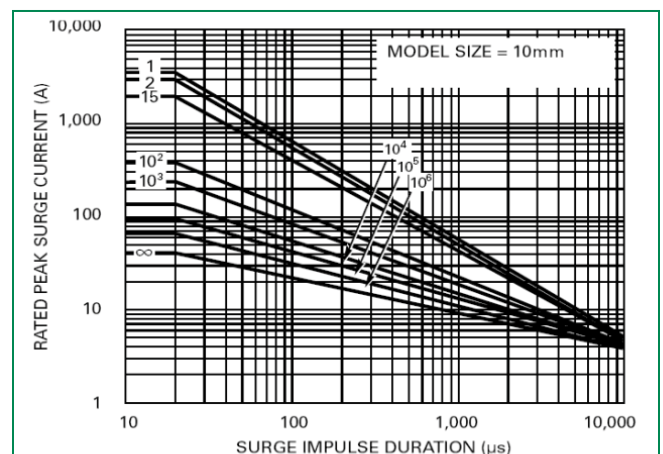

Note: Repetitive surge capability is qualified and tested based on 8/20us current waveform (not combination waveform) and UL1449 40.73 (Edition 4) test condition.

NOTE: If pulse ratings are exceeded, a shift of V_{NDCI} (at specified current) of more than +/-10% could result. This type of shift, which normally results in a decrease of V_{NDCI} , may result in the device not meeting the original published specifications, but does not prevent the device from continuing to function, and to provide ample protection.

Repetitive Surge Capability for 10mm Parts

V10x50P - V10x95P

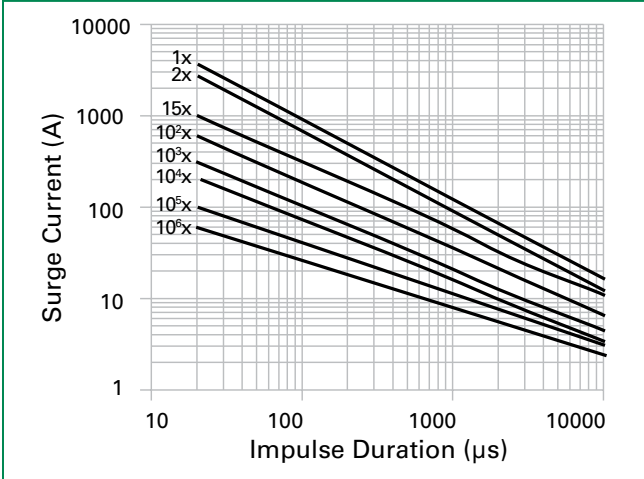

Repetitive Surge Capability for 14mm Parts

V14x50P - V14x95P

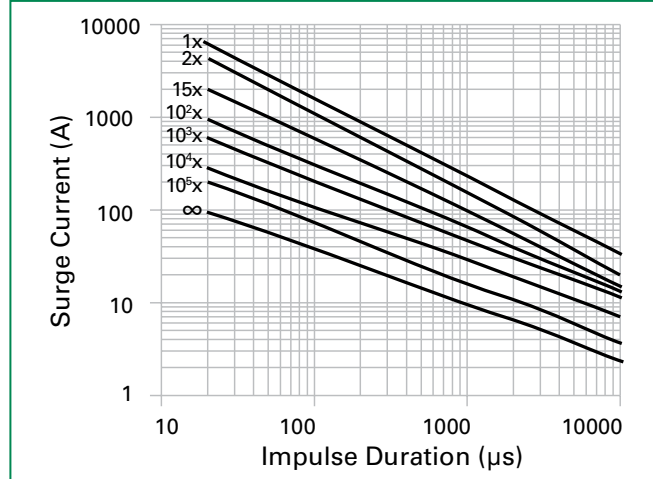

Repetitive Surge Capability for 20mm Parts

V20x50P - V20x95P

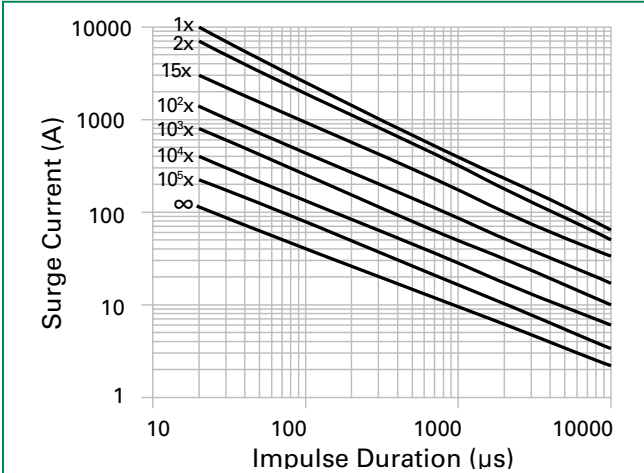

Repetitive Surge Capability for 14mm Parts

V14x115P - V14x625P

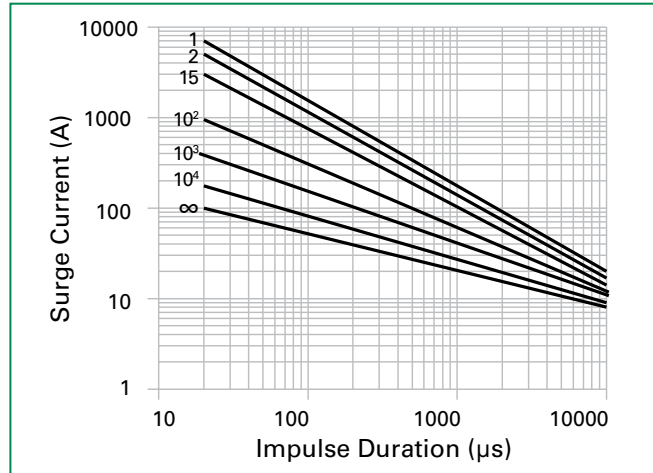

Repetitive Surge Capability for 20mm Parts

V20x115P - V20x625P



Note: Repetitive surge capability is qualified and tested based on 8/20us current waveform (not combination waveform) and UL1449 40.73 (Edition 4) test condition.

Wave Solder Profile

Non Lead-free Profile

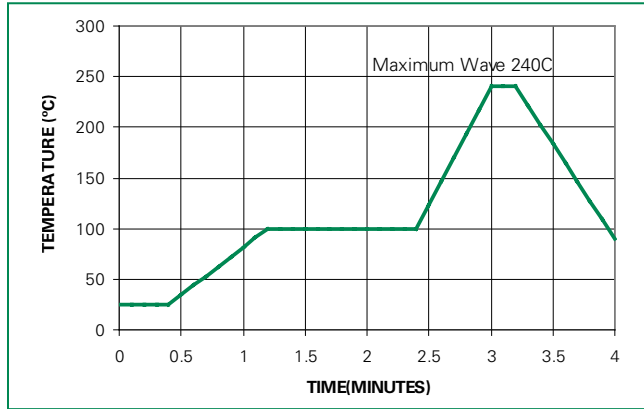

Lead-free Profile

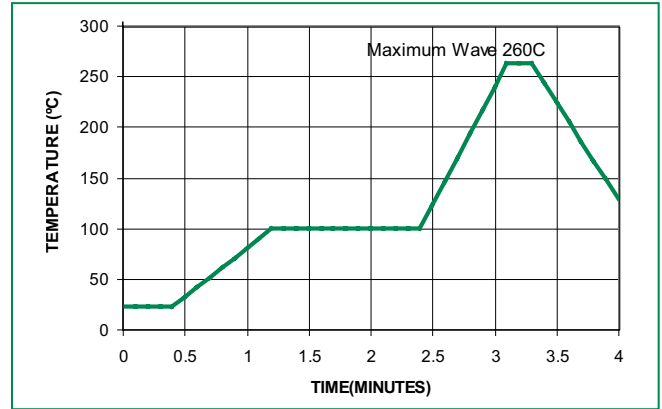

Physical Specifications

| | |
|----------------------------------|--|
| Lead Material | Copper Clad Steel Wire |
| Soldering Characteristics | Solderability per MIL-STD-202, Method 208 |
| Insulating Material | Cured, Silicone meets UL94V-0 requirements |
| Device Labeling | Marked with LF, voltage and date code |

Environmental Specifications

| | |
|-----------------------------|---|
| Humidity Aging | +85°C, 85% RH, 1500 hours +/-10% typical voltage change |
| Thermal Shock | -55°C to +125°C, 1000 cycles +/-10% typical voltage change |
| Solvent Resistance | MIL-STD-202, Method 215 |
| Moisture Sensitivity | Level 1, J-STD-020 |

Product Dimensions (mm)

Straight Lead Option

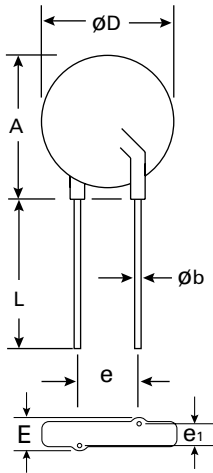

Outer Crimped Lead Option

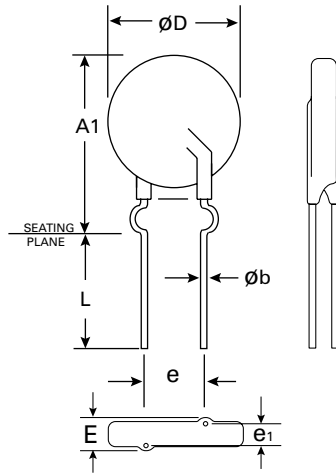

Inner Crimped Lead Option

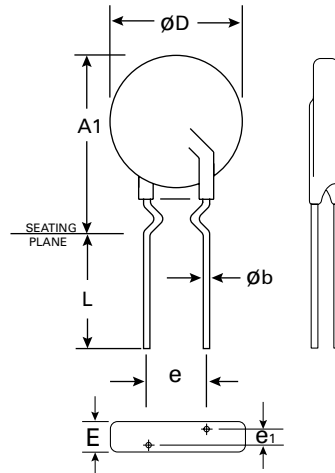

| Dimension | V _{RMS} Voltage Model | 10mm Size | | 14mm Size | | 20mm Size | |
|-------------------|--------------------------------|--------------|--------------|--------------|--------------|--------------|--------------|
| | | Min. mm (in) | Max. mm (in) | Min. mm (in) | Max. mm (in) | Min. mm (in) | Max. mm (in) |
| A | 11 - 320 | - | 16 (0.630) | - | 20 (0.787) | - | 26.5 (1.043) |
| | 385 - 625 | - | 17 (0.689) | - | 20.5 (0.807) | - | 28.0 (1.102) |
| A1 | All | - | 19.5 (0.768) | - | 22.5 (0.886) | - | 29.0 (1.142) |
| ØD | All | - | 12.5 (0.492) | - | 17 (0.669) | - | 23.0 (0.906) |
| e | 11 - 95 | 6.5 (0.256) | 8.5 (0.335) | 6.5 (0.256) | 8.5 (0.335) | 6.5 (0.256) | 8.5 (0.335) |
| | ≥115 | | | | | 9.0 (0.354) | 11.0 (0.433) |
| e ₁ | 11 - 30 | 1.0 (0.039) | 3.0 (0.118) | 1.0 (0.039) | 3.0 (0.118) | 1.0 (0.039) | 3.0 (0.118) |
| | 35 - 320 | 1.5 (0.059) | 3.5 (0.138) | 1.5 (0.059) | 3.5 (0.138) | 1.5 (0.059) | 3.5 (0.138) |
| | 385 - 625 | 2.5 (0.098) | 5.5 (0.217) | 2.5 (0.098) | 5.5 (0.217) | 2.5 (0.098) | 5.5 (0.217) |
| E | 11 - 30 | - | 5.0 (0.197) | - | 5.0 (0.197) | - | 5.0 (0.197) |
| | 35 - 320 | - | 5.6 (0.220) | - | 5.6 (0.220) | - | 5.6 (0.220) |
| | 385 - 510 | - | 7.3 (0.287) | - | 7.3 (0.287) | - | 7.3 (0.287) |
| | 550 - 625 | - | 8.3 (0.327) | - | 8.3 (0.327) | - | 8.3 (0.327) |
| Øb | All | 0.76 (0.030) | 0.86 (0.034) | 0.76 (0.030) | 0.86 (0.034) | 0.76 (0.030) | 0.86 (0.034) |
| L | All | 25.4 (1.00) | - | 25.4 (1.00) | - | 25.4 (1.00) | - |
| L _{TRIM} | All | 2.5 (0.098) | 4.5 (0.177) | 2.5 (0.098) | 4.5 (0.177) | 2.5 (0.098) | 4.5 (0.177) |

Note: Dimensions in Millimetres (Inches) are typical.

Tape and Reel Specifications

10, 14, and 20mm Devices

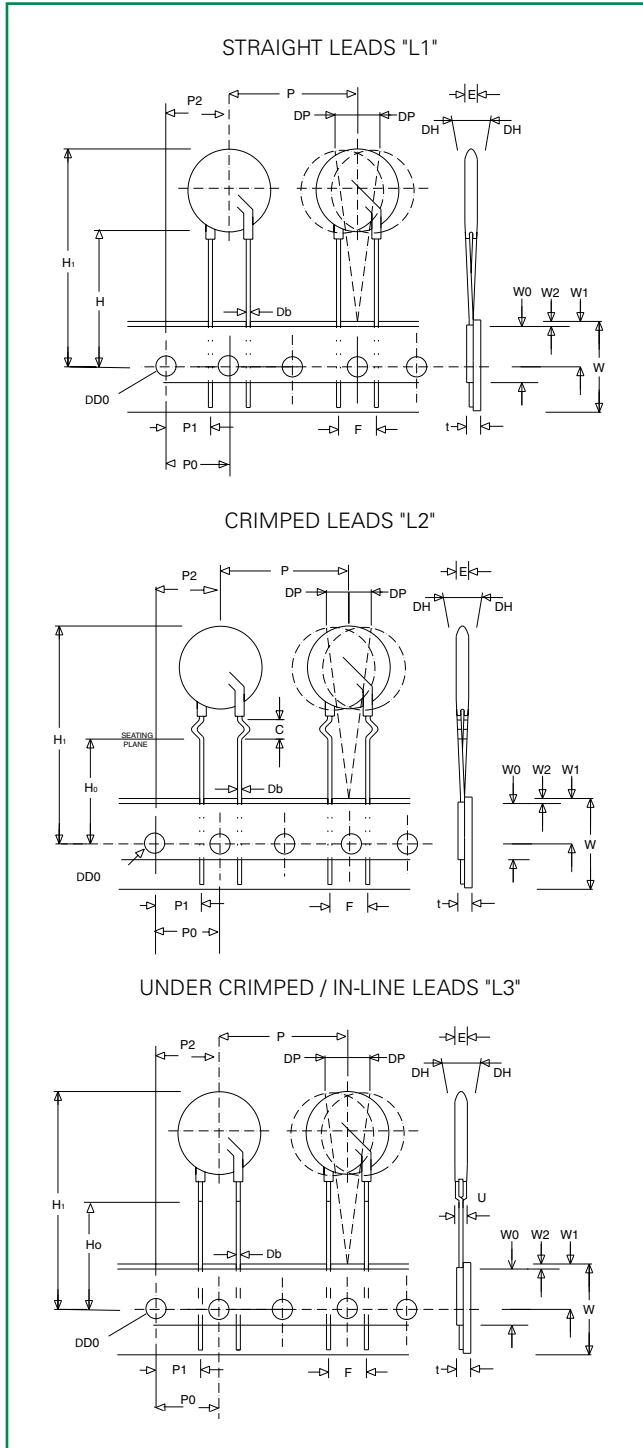

Refer next page for dimension measurement specifications.

Disclaimer Notice - Information furnished is believed to be accurate and reliable. However, users should independently evaluate the suitability of and test each product selected for their own applications. Littelfuse products are not designed for, and may not be used in, all applications. Read complete Disclaimer Notice at www.littelfuse.com/disclaimer-electronics.