

HMOV™ Varistor Series



Description



The HMOV™ Varistor Series is specifically designed for applications requiring high surge energy absorption and high operating temperature of 125°C.

The maximum peak surge current is rated up to 10kA (8/20µs pulse) to protect against indirect lightning strikes, switching surge transients, and abnormally fast transients.

Features

- High operating temperature combined with high isolation voltage capability: 125°C and 2500V, respectively
- High surge current withstanding capability up to 10kA (8/20µs pulse)
- Complies with 1000 cycle, -55°C to 125°C, Thermal Shock Cycling Test
- Wide operating voltage range
- Three disc sizes available: 10mm, 14mm, and 20mm
- Lead-free, Halogen-free, and RoHS compliant

Agency Approvals

Agency	Agency Approval	Agency File Number
	UL1449	E320116
	IEC 60950-1(Annex Q) IECQ CS 042200 GB 0001	IECQ-C BSI 15.0013 E1291/F

Additional Information



Datashheet



Resources



Samples

Applications

- LED lighting
- Security System (fire alarm or smoke detector)
- Solar Power Inverter
- Automation control
- Power Supply Unit (outdoor and industrial)

Absolute Maximum Ratings

• See Device Ratings and Specifications chart for ratings of individual members of a series.

	Low Voltage Series	Units
Continuous:		
Steady State Applied Voltage:		
AC Voltage Range ($V_{M(AC)RMS}$)	11 to 625	V
DC Voltage Range ($V_{M(DC)}$)	14 to 825	V
Transient:		
Non-Repetitive Surge Current, 8/20µs Waveform (I_{TM})	800 to 10,000	A
Non-Repetitive Energy Capability, 2ms Waveform (W_{TM})	0.8 to 150	J
Operating Ambient Temperature Range (T_A)	-55 to +125	°C
Storage Temperature Range (T_{STG})	-55 to +150	°C
Temperature Coefficient (αV) of Clamping Voltage (V_C) at Specified Test Current	< 0.01%	°C
Hi-Pot Encapsulation (Isolation Voltage Capability)	2500	V
Silicone Coating Insulation Resistance	>1,000	MΩ

CAUTION: Stresses above those listed in "Absolute Maximum Ratings" may cause permanent damage to the device. This is a stress only rating and operation of the device at these or any other conditions above those indicated in the operational sections of this specification is not implied.

HMOV[™] Series Device Ratings and Specifications

Silicone Coated Models		Size Disc Dia. (mm)	Maximum Rating (125°C)					Specifications (25°C)				
			Max Continuous Voltage		Max Peak Current (8/20µs)		Energy Rating (2ms, 1 pulse)	Varistor Voltage at 1mA		Maximum Clamping Voltage (8 x 20µs)		Typical Capacitance f = 1MHz
			V _{M(AC) RMS}	V _{M(DC)}	I _{TM} 1 x Pulse	I _{TM} 2 x Pulses	W _{TM}	V _{NOM} Min	V _{NOM} Max	V _C	I _{PK}	C
Part Number (Base part)	Branding		(V)	(V)	(A)	(A)	(J)	(V)	(V)	(V)	(A)	(pF)
V10H11P	P10H11	10	11	14	1500	800	4.2	16.2	19.8	36	5	5450
V14H11P	P14H11	14	11	14	3000	1800	8	16.2	19.8	36	10	12000
V20H11P	P20H11	20	11	14	5000	3000	25	16.2	19.8	36	20	26000
V10H14P	P10H14	10	14	18	1500	800	5	19.8	24.2	43	5	4650
V14H14P	P14H14	14	14	18	3000	1800	10	19.8	24.2	43	10	10200
V20H14P	P20H14	20	14	18	5000	3000	28	19.8	24.2	43	20	22200
V10H17P	P10H17	10	17	22	1500	800	6.5	24.3	29.7	53	5	3900
V14H17P	P14H17	14	17	22	3000	1800	13	24.3	29.7	53	10	8700
V20H17P	P20H17	20	17	22	5000	3000	35	24.3	29.7	53	20	18750
V10H20P	P10H20	10	20	26	1500	800	10	29.7	36.3	65	5	3400
V14H20P	P14H20	14	20	26	3000	1800	20	29.7	36.3	65	10	7500
V20H20P	P20H20	20	20	26	5000	3000	58	29.7	36.3	65	20	15000
V10H23P	P10H23	10	23	28	1500	800	12	32.4	39.6	71	5	3200
V14H23P	P14H23	14	23	28	3000	1800	23	32.4	39.6	71	10	7000
V20H23P	P20H23	20	23	28	5000	3000	70	32.4	39.6	71	20	14000
V10H25P	P10H25	10	25	31	1500	800	13	35.1	42.9	77	5	2900
V14H25P	P14H25	14	25	31	3000	1800	25	35.1	42.9	77	10	6200
V20H25P	P20H25	20	25	31	5000	3000	77	35.1	42.9	77	20	13500
V10H30P	P10H30	10	30	38	1500	800	15.5	42.3	51.7	93	5	2550
V14H30P	P14H30	14	30	38	3000	1800	32	42.3	51.7	93	10	5550
V20H30P	P20H30	20	30	38	5000	3000	90	42.3	51.7	93	20	12000
V10H35P	P10H35	10	35	45	1500	800	20	50.4	61.6	110	5	2200
V14H35P	P14H35	14	35	45	3000	1800	40	50.4	61.6	110	10	5000
V20H35P	P20H35	20	35	45	5000	3000	115	50.4	61.6	110	20	10500
V10H40P	P10H40	10	40	56	1500	800	25	61.2	74.8	135	5	1850
V14H40P	P14H40	14	40	56	3000	1800	50	61.2	74.8	135	10	4000
V20H40P	P20H40	20	40	56	5000	3000	140	61.2	74.8	135	20	8500
V10H50P	P10H50	10	50	65	3500	3000	20	73.8	90.2	135	25	1400
V14H50P	P14H50	14	50	65	6500	5000	40	73.8	90.2	145	50	3000
V20H50P	P20H50	20	50	65	10000	7000	80	73.8	90.2	145	100	6000
V10H60P	P10H60	10	60	85	3500	3000	24	90	110	165	25	1200
V14H60P	P14H60	14	60	85	6500	5000	50	90	110	175	50	2500
V20H60P	P20H60	20	60	85	10000	7000	100	90	110	175	100	5200
V10H75P	P10H75	10	75	100	3500	3000	29	108	132	200	25	1100
V14H75P	P14H75	14	75	100	6500	5000	60	108	132	210	50	2300
V20H75P	P20H75	20	75	100	10000	7000	120	108	132	210	100	4800
V10H95P	P10H95	10	95	125	3500	3000	36	135	165	250	25	800
V14H95P	P14H95	14	95	125	6500	5000	75	135	165	250	50	1700
V20H95P	P20H95	20	95	125	10000	7000	150	135	165	250	100	3700
V10H115P	P10H115	10	115	153	3500	3000	30	162	198	300	25	465
V14H115P	P14H115	14	115	153	6500	5000	50	162	198	300	50	1190
V20H115P	P20H115	20	115	153	10000	7000	120	162	198	300	100	2400
V10H130P	P10H130	10	130	170	3500	3000	40	184.5	225.5	340	25	450
V14H130P	P14H130	14	130	170	6500	5000	60	184.5	225.5	340	50	1000
V20H130P	P20H130	20	130	170	10000	7000	145	184.5	225.5	340	100	1900
V10H140P	P10H140	10	140	180	3500	3000	45	198	242	360	25	400

Note: 1. Average power dissipation of transients not to exceed 0.4W, 0.6W or 1W for model sizes 10mm, 14mm, and 20mm, respectively.

HMOV™ Series Device Ratings and Specifications

		Maximum Rating (125°C)						Specifications (25°C)				
		Size Disc Dia. (mm)	Max Continuous Voltage		Max Peak Current (8/20µs)		Energy Rating (2ms, 1 pulse)	Varistor Voltage at 1mA		Maximum Clamping Voltage (8 x 20µs)		Typical Capacitance f = 1MHz
Part Number (Base part)	Branding		$V_{M(AC) RMS}$	$V_{M(DC)}$	$I_{TM} 1 \times \text{Pulse}$	$I_{TM} 2 \times \text{Pulses}$	W_{TM}	$V_{NOM} \text{ Min}$	$V_{NOM} \text{ Max}$	V_C	I_{PK}	C
			(V)	(V)	(A)	(A)	(J)	(V)	(V)	(V)	(A)	(pF)
V14H140P	P14H140	14	140	180	6500	5000	65	198	242	360	50	900
V20H140P	P20H140	20	140	180	10000	7000	155	198	242	360	100	1750
V10H150P	P10H150	10	150	200	3500	3000	50	216	264	395	25	360
V14H150P	P14H150	14	150	200	6500	5000	70	216	264	395	50	800
V20H150P	P20H150	20	150	200	10000	7000	165	216	264	395	100	1600
V10H175P	P10H175	10	175	225	3500	3000	55	243	297	455	25	350
V14H175P	P14H175	14	175	225	6500	5000	80	243	297	455	50	700
V20H175P	P20H175	20	175	225	10000	7000	180	243	297	455	100	1400
V10H230P	P10H230	10	230	300	3500	3000	60	324	396	595	25	250
V14H230P	P14H230	14	230	300	6500	5000	105	324	396	595	50	550
V20H230P	P20H230	20	230	300	10000	7000	225	324	396	595	100	1100
V10H250P	P10H250	10	250	320	3500	3000	65	351	429	650	25	220
V14H250P	P14H250	14	250	320	6500	5000	115	351	429	650	50	500
V20H250P	P20H250	20	250	320	10000	7000	240	351	429	650	100	1000
V10H275P	P10H275	10	275	350	3500	3000	70	387	473	710	25	200
V14H275P	P14H275	14	275	350	6500	5000	130	387	473	710	50	450
V20H275P	P20H275	20	275	350	10000	7000	260	387	473	710	100	900
V10H300P	P10H300	10	300	385	3500	3000	75	423	517	775	25	180
V14H300P	P14H300	14	300	385	6500	5000	140	423	517	775	50	400
V20H300P	P20H300	20	300	385	10000	7000	290	423	517	775	100	800
V10H320P	P10H320	10	320	420	3500	3000	80	459	561	840	25	170
V14H320P	P14H320	14	320	420	6500	5000	150	459	561	840	50	380
V20H320P	P20H320	20	320	420	10000	7000	320	459	561	840	100	750
V10H385P	P10H385	10	385	505	3500	3000	85	558	682	1025	25	160
V14H385P	P14H385	14	385	505	6500	5000	175	558	682	1025	50	360
V20H385P	P20H385	20	385	505	10000	7000	325	558	682	1025	100	700
V10H420P	P10H420	10	420	560	3500	3000	90	612	748	1120	25	140
V14H420P	P14H420	14	420	560	6500	5000	185	612	748	1120	50	300
V20H420P	P20H420	20	420	560	10000	7000	330	612	748	1120	100	600
V10H440P	P10H440	10	440	585	3500	3000	95	643.5	786.5	1180	25	130
V14H440P	P14H440	14	440	585	6500	5000	185	643.5	786.5	1180	50	260
V20H440P	P20H440	20	440	585	10000	7000	340	643.5	786.5	1180	100	500
V10H460P	P10H460	10	460	615	3500	3000	95	675	825	1240	25	120
V14H460P	P14H460	14	460	615	6500	5000	190	675	825	1240	50	220
V20H460P	P20H460	20	460	615	10000	7000	370	675	825	1240	100	400
V10H510P	P10H510	10	510	670	3500	3000	98	738	902	1355	25	110
V14H510P	P14H510	14	510	670	6500	5000	205	738	902	1355	50	200
V20H510P	P20H510	20	510	670	10000	7000	410	738	902	1355	100	350
V10H550P	P10H550	10	550	745	3500	3000	98	819	1001	1500	25	100
V14H550P	P14H550	14	550	745	6500	5000	210	819	1001	1500	50	180
V20H550P	P20H550	20	550	745	10000	7000	450	819	1001	1500	100	300
V10H625P	P10H625	10	625	825	3500	3000	110	900	1100	1650	25	90
V14H625P	P14H625	14	625	825	6500	5000	235	900	1100	1650	50	160
V20H625P	P20H625	20	625	825	10000	7000	490	900	1100	1650	100	250

Note: 1. Average power dissipation of transients not to exceed 0.4W, 0.6W or 1W for model sizes 10mm, 14mm, and 20mm respectively..

Current Energy and Power Dissipation Ratings

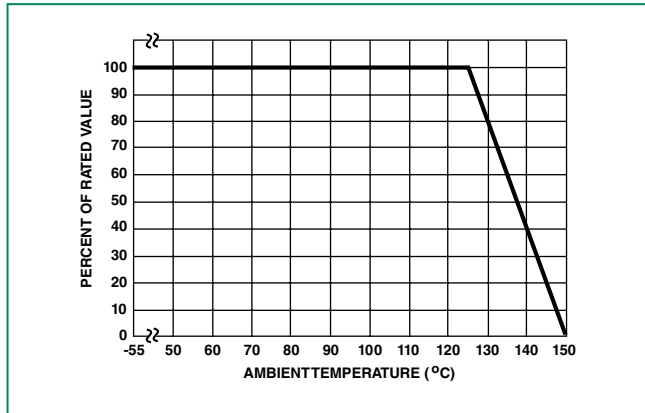

Note:
The peak surge current and energy ratings must be reduced for applications exceeding 125°C ambient temperature.

Peak Pulse Current Test Waveform for Clamping Voltage

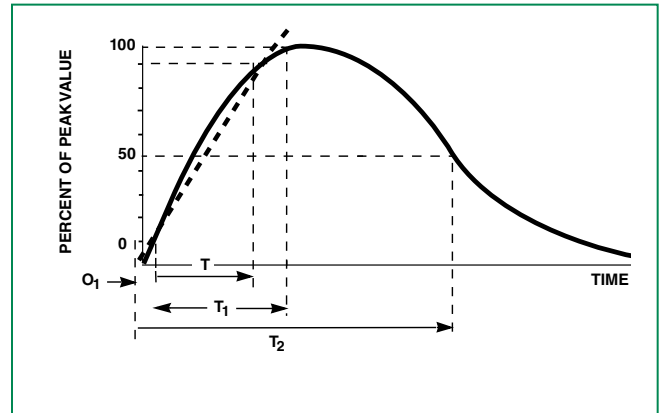

O_1 = Virtual Origin of Wave
 T = Time from 10% to 90% of Peak
 T_1 = Rise Time = $1.25 \times T$
 T_2 = Decay Time
Example - For an 8/20 μ s Current Waveform:
 8μ s = T_1 = Rise Time
 20μ s = T_2 = Decay Time

Maximum Clamping Voltage for 10mm Parts

V10x11P - V10x40P

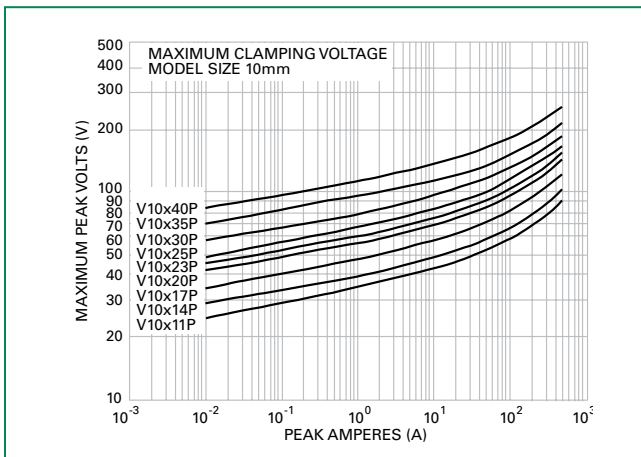

Maximum Clamping Voltage for 20mm Parts

V20x11P - V20x40P

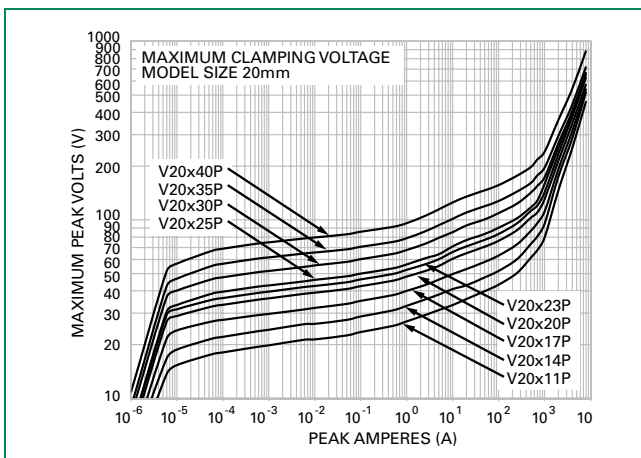

Maximum Clamping Voltage for 14mm Parts

V14x11P - V14x40P

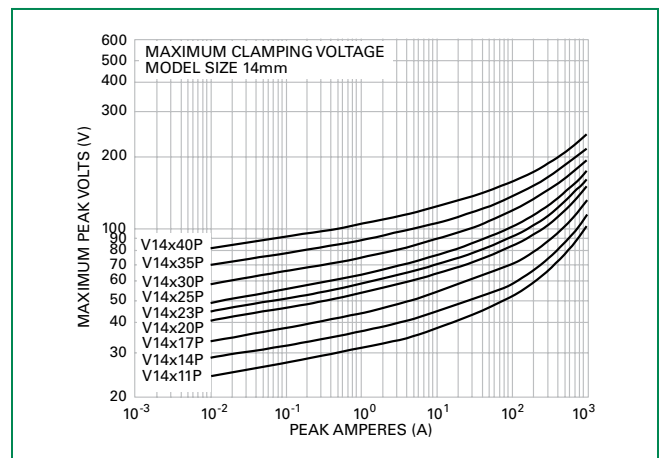

Maximum Clamping Voltage for 10mm Parts

V10x50P - V10x115P

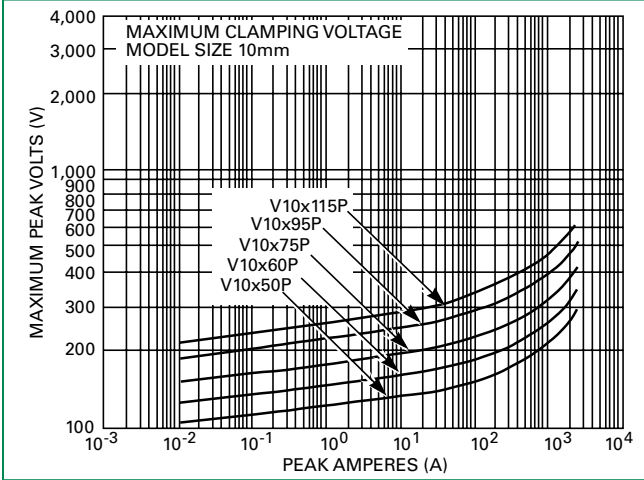

Maximum Clamping Voltage for 10mm Parts

V10x130P - V10x625P

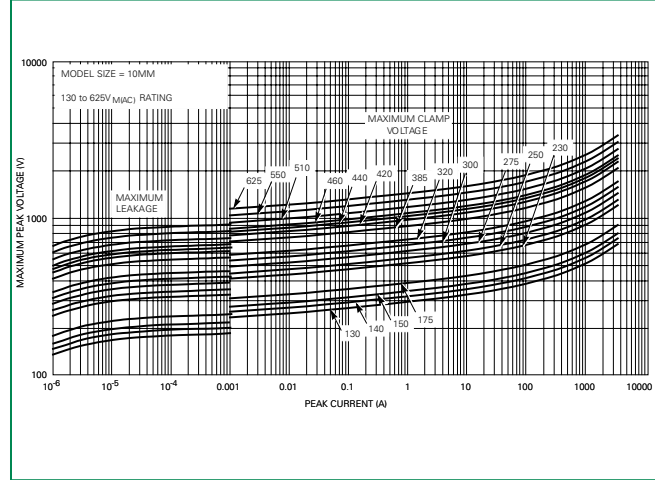

Maximum Clamping Voltage for 20mm Parts

V20x50P - V20x115P

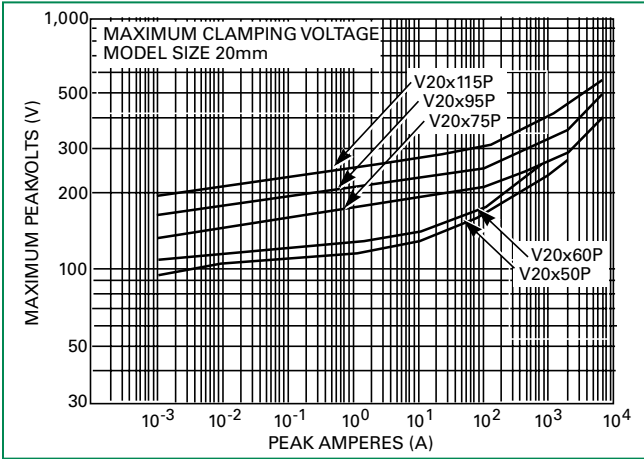

Maximum Clamping Voltage for 14mm Parts

V14x50P - V14x115P

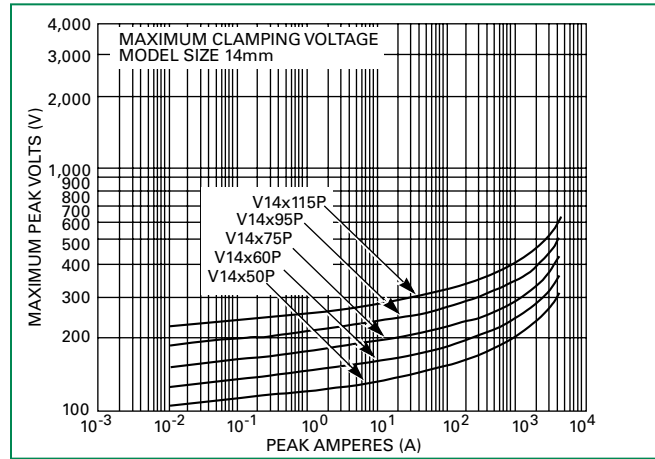

Maximum Clamping Voltage for 14mm Parts

V14x130P - V14x625P

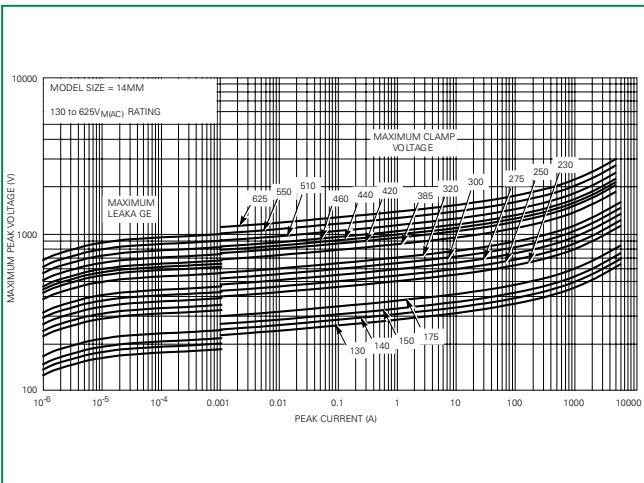

Maximum Clamping Voltage for 20mm Parts

V20x130P - V20x625P

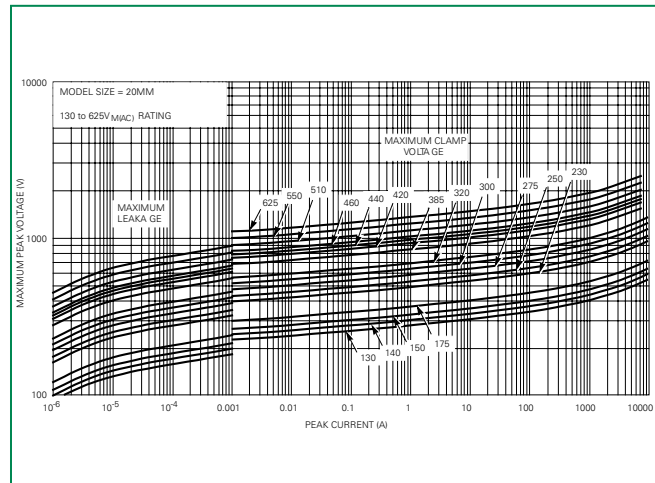

Repetitive Surge Capability for 10mm Parts

V10x11P - V10x40P

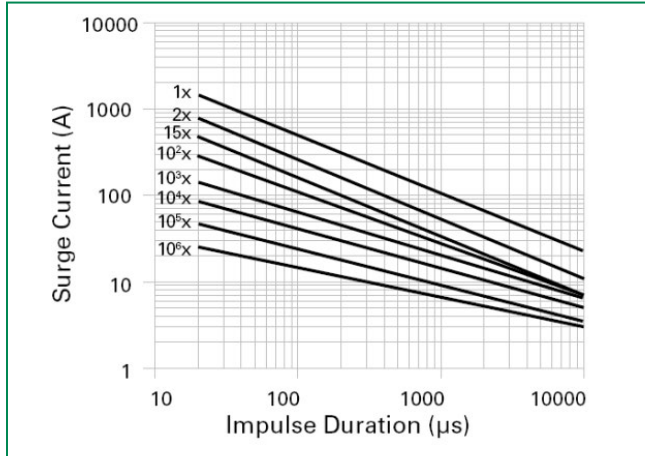

Repetitive Surge Capability for 14mm Parts

V14x11P - V14x40P

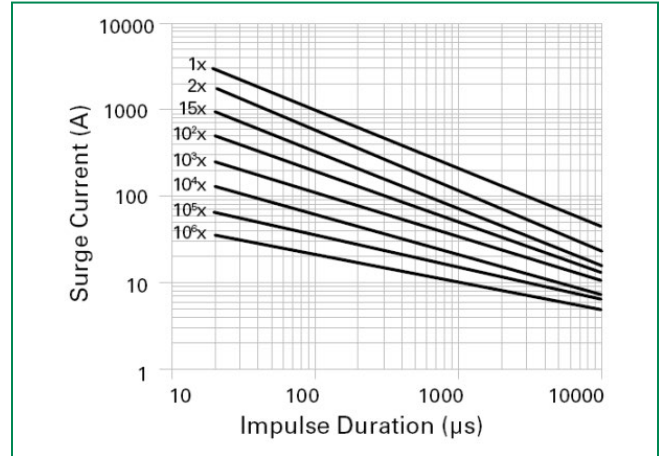

Repetitive Surge Capability for 20mm Parts

V20x11P - V20x40P

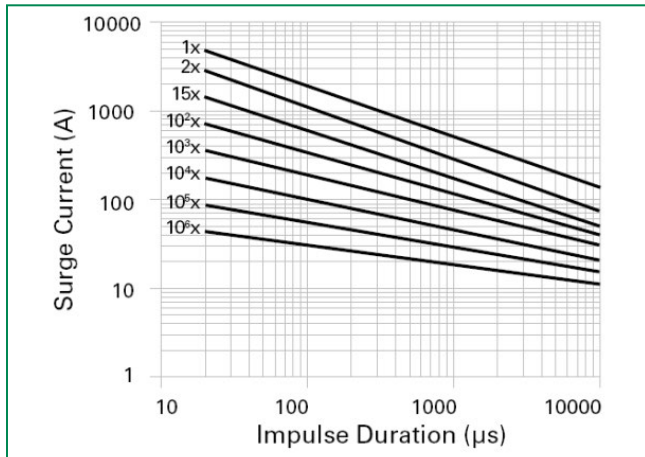

Maximum Clamping Voltage 10mm Parts

V10x115P - V10x625P

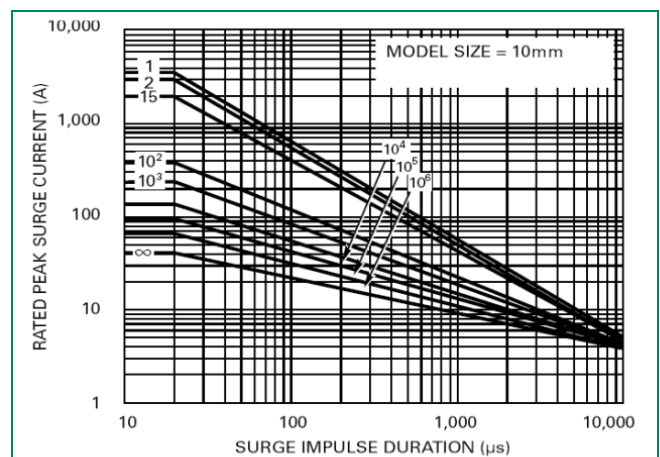

Note: Repetitive surge capability is qualified and tested based on 8/20us current waveform (not combination waveform) and UL1449 40.73 (Edition 4) test condition.

NOTE: If pulse ratings are exceeded, a shift of V_{NDCI} (at specified current) of more than +/-10% could result. This type of shift, which normally results in a decrease of V_{NDCI} , may result in the device not meeting the original published specifications, but does not prevent the device from continuing to function, and to provide ample protection.

Repetitive Surge Capability for 10mm Parts

V10x50P - V10x95P

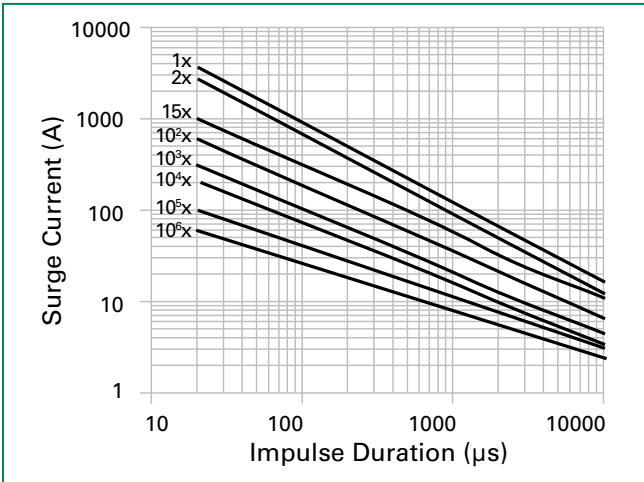

Repetitive Surge Capability for 14mm Parts

V14x50P - V14x95P

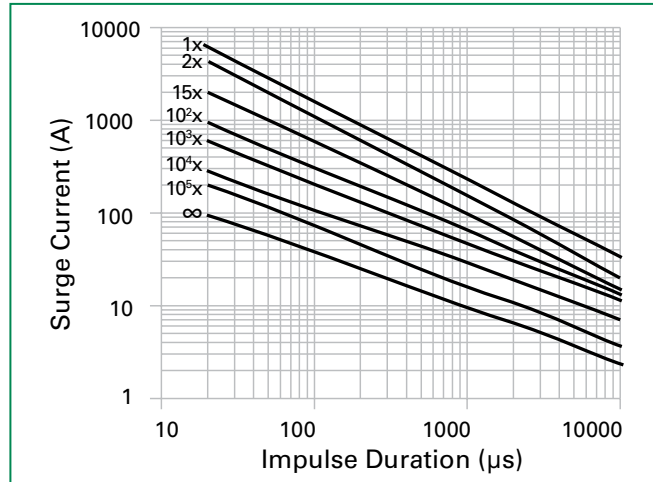

Repetitive Surge Capability for 20mm Parts

V20x50P - V20x95P

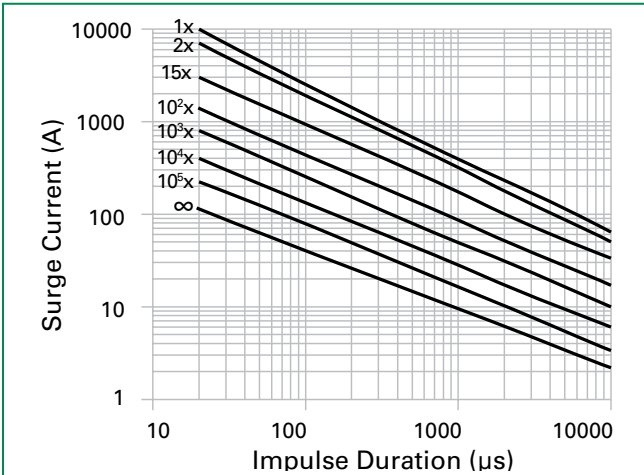

Repetitive Surge Capability for 14mm Parts

V14x115P - V14x625P

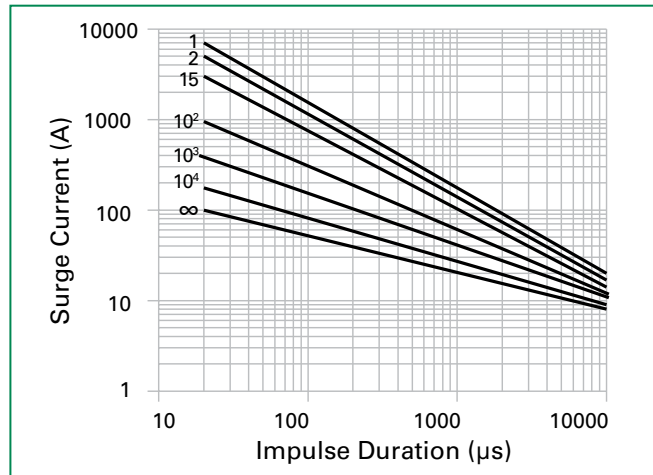

Repetitive Surge Capability for 20mm Parts

V20x115P - V20x625P

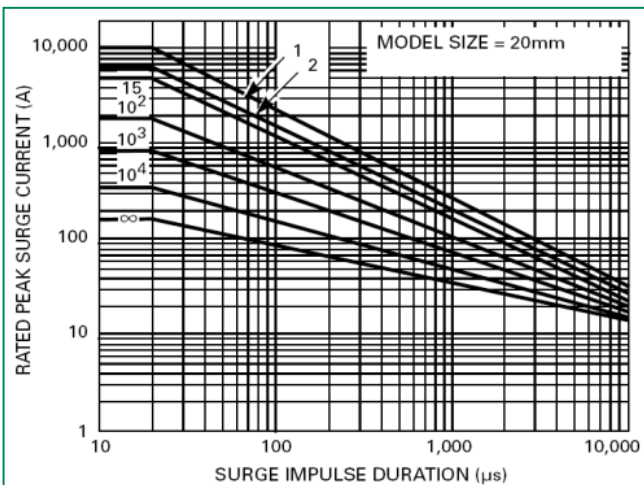

Note: Repetitive surge capability is qualified and tested based on 8/20µs current waveform (not combination waveform) and UL1449 40.73 (Edition 4) test condition.

Wave Solder Profile

Non Lead-free Profile

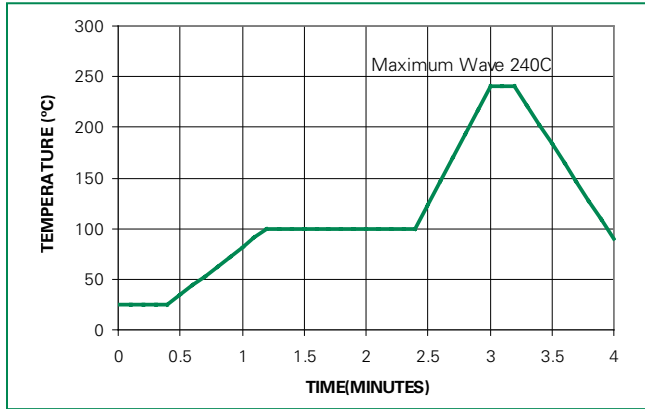

Lead-free Profile

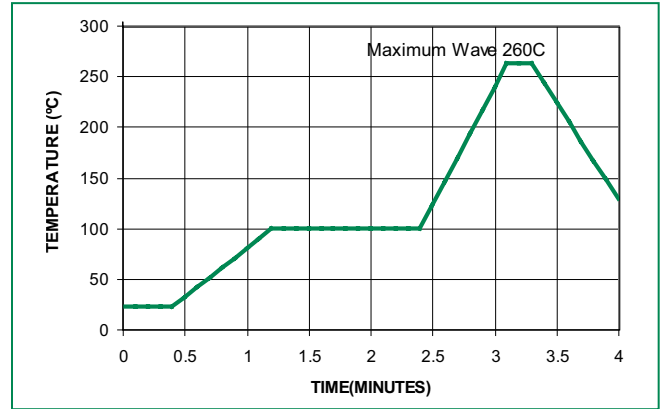

Physical Specifications

Lead Material	Copper Clad Steel Wire
Soldering Characteristics	Solderability per MIL-STD-202, Method 208
Insulating Material	Cured, Silicone meets UL94V-0 requirements
Device Labeling	Marked with LF, voltage and date code

Environmental Specifications

Humidity Aging	+85°C, 85% RH, 1500 hours +/-10% typical voltage change
Thermal Shock	-55°C to +125°C, 1000 cycles +/-10% typical voltage change
Solvent Resistance	MIL-STD-202, Method 215
Moisture Sensitivity	Level 1, J-STD-020

Product Dimensions (mm)

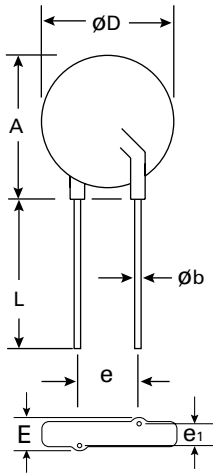
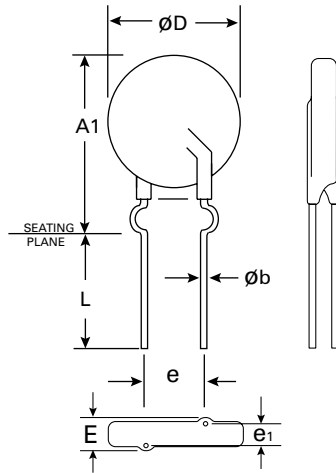
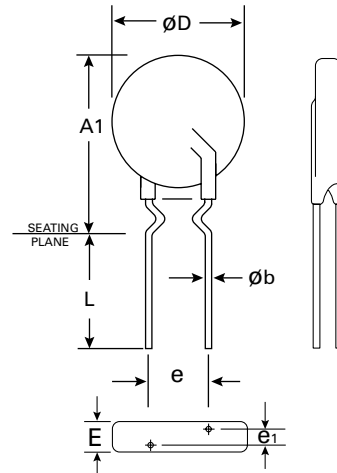
Straight Lead Option

Outer Crimped Lead Option

Inner Crimped Lead Option

Dimension	V _{RMS} Voltage Model	10mm Size		14mm Size		20mm Size	
		Min. mm (in)	Max. mm (in)	Min. mm (in)	Max. mm (in)	Min. mm (in)	Max. mm (in)
A	11 - 320	-	16 (0.630)	-	20 (0.787)	-	26.5 (1.043)
	385 - 625	-	17 (0.689)	-	20.5 (0.807)	-	28.0 (1.102)
A1	All	-	19.5 (0.768)	-	22.5 (0.886)	-	29.0 (1.142)
ØD	All	-	12.5 (0.492)	-	17 (0.669)	-	23.0 (0.906)
e	11 - 95	6.5 (0.256)	8.5 (0.335)	6.5 (0.256)	8.5 (0.335)	6.5 (0.256)	8.5 (0.335)
	≥115					9.0 (0.354)	11.0 (0.433)
e₁	11 - 30	1.0 (0.039)	3.0 (0.118)	1.0 (0.039)	3.0 (0.118)	1.0 (0.039)	3.0 (0.118)
	35 - 320	1.5 (0.059)	3.5 (0.138)	1.5 (0.059)	3.5 (0.138)	1.5 (0.059)	3.5 (0.138)
	385 - 625	2.5 (0.098)	5.5 (0.217)	2.5 (0.098)	5.5 (0.217)	2.5 (0.098)	5.5 (0.217)
E	11 - 30	-	5.0 (0.197)	-	5.0 (0.197)	-	5.0 (0.197)
	35 - 320	-	5.6 (0.220)	-	5.6 (0.220)	-	5.6 (0.220)
	385 - 510	-	7.3 (0.287)	-	7.3 (0.287)	-	7.3 (0.287)
	550 - 625	-	8.3 (0.327)	-	8.3 (0.327)	-	8.3 (0.327)
Øb	All	0.76 (0.030)	0.86 (0.034)	0.76 (0.030)	0.86 (0.034)	0.76 (0.030)	0.86 (0.034)
L	All	25.4 (1.00)	-	25.4 (1.00)	-	25.4 (1.00)	-
L_{TRIM}	All	2.5 (0.098)	4.5 (0.177)	2.5 (0.098)	4.5 (0.177)	2.5 (0.098)	4.5 (0.177)

Note: Dimensions in Millimetres (Inches) are typical.

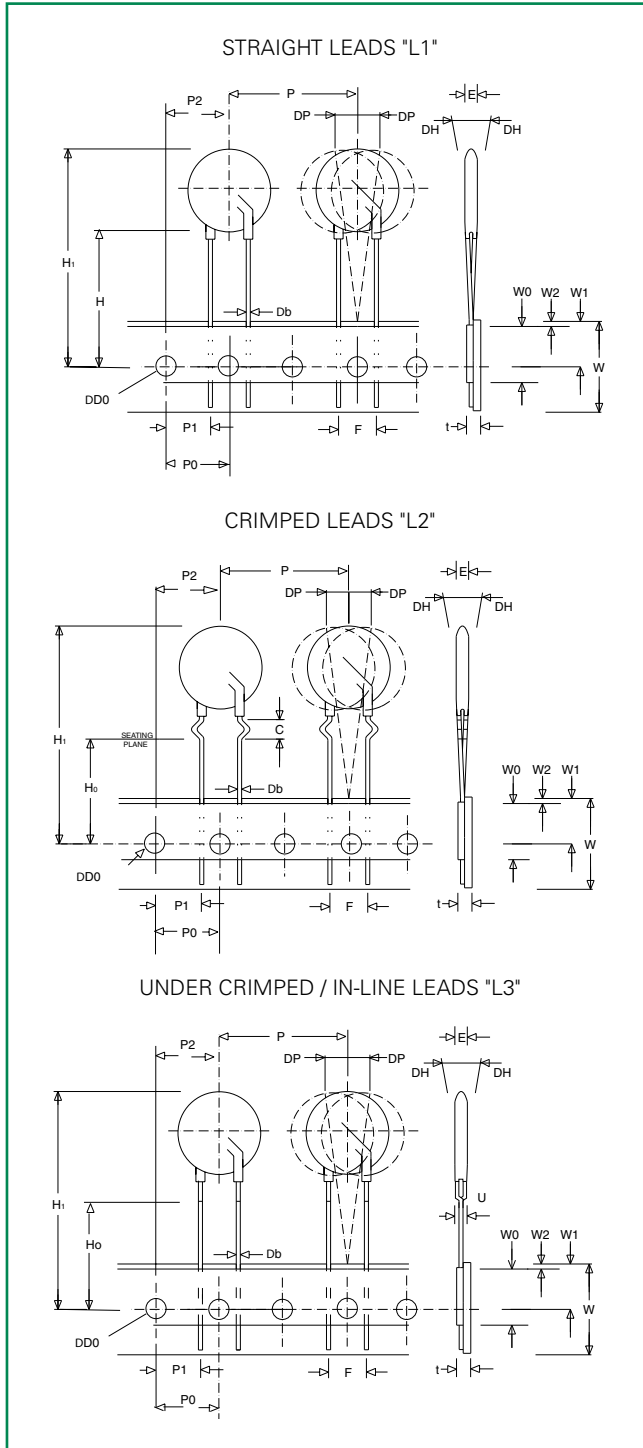
Tape and Reel Specifications

10, 14, and 20mm Devices



Refer next page for dimension measurement specifications.

Disclaimer Notice - Information furnished is believed to be accurate and reliable. However, users should independently evaluate the suitability of and test each product selected for their own applications. Littelfuse products are not designed for, and may not be used in, all applications. Read complete Disclaimer Notice at www.littelfuse.com/disclaimer-electronics.