

ZA Varistor Series



Description

The ZA Series of transient voltage surge suppressors are radial leaded varistors (MOVs) designed for use in the protection of low and medium-voltage circuits and systems. Typical applications include motor control, telecom, solenoid, and power supply circuits to protect circuit board components and maintain data integrity.

These devices are available in five model sizes: 5mm, 7mm, 10mm, 14mm and 20mm, and feature a wide V_{DC} voltage range of 5.5V to 615V.

See ZA Series Device Ratings and Specifications Table for part number and brand information.

Agency Approvals

| Agency | Agency Approval | Agency File Number |
|---|---|--------------------|
|  | UL1449* | E320116 |
|  | CECC 42201-006 IEC 61051-1 IEC 61051-2 IEC 60950-1 (Annex Q)** | 116895 |
|  | CECC 42201-006 IEC 61051-1 IEC 61051-2 IEC 60950-1 (Annex Q)** | E1273/F |

Notes:
 * - Except parts V8ZAxxP and V12ZAxxP
 ** - For 14mm (V120 to V180) and 20mm (V120 to V180).

Features

- Lead-free, Halogen-Free and RoHS compliant
- Wide operating voltage range $V_{M(AC)RMS}$ 4V to 460V
- DC voltage ratings 5.5V to 615V
- No derating up to 85°C ambient
- 5 model sizes available: 5, 7, 10, 14, and 20mm
- Radial lead package for hard-wired or printed circuit board designs
- Available in tape and reel or bulk pack
- Standard lead form options

Additional Information



Datasheet



Resources



Samples

Absolute Maximum Ratings

• For ratings of individual members of a series, see Device Ratings and Specifications chart

| Continuous | ZA Series | Units |
|--|-------------|------------|
| Steady State Applied Voltage: | | |
| AC Voltage Range ($V_{M(AC)RMS}$) | 4 to 460 | V |
| DC Voltage Range ($V_{M(DC)}$) | 5.5 to 615 | V |
| Transients: | | |
| Peak Pulse Current (I_{TM}) For 8/20 μ s Current Wave (See Figure 2) | 50 to 6500 | A |
| Single Pulse Energy Range (Note 1) For 10/1000 μ s Current Wave (W_{TM}) | 0.1 to 52 | J |
| Operating Ambient Temperature Range (T_A) | -55 to +85 | °C |
| Storage Temperature Range (T_{STG}) | -55 to +125 | °C |
| Temperature Coefficient (α) of Clamping Voltage (V_C) at Specified Test Current | <0.01 | %/°C |
| Hi-Pot Encapsulation (COATING Isolation Voltage Capability) (Dielectric must withstand indicated DC voltage for one minute per MIL-STD-202, Method 301) | 2500 | V |
| COATING Insulation Resistance | 1000 | M Ω |

CAUTION: Stresses above those listed in "Absolute Maximum Ratings" may cause permanent damage to the device. This is a stress only rating and operation of the device at these or any other conditions above those indicated in the operational sections of this specification is not implied.

ZA Series Ratings & Specifications

| Part Number | Branding | Model Size Disc Dia. (mm) | Maximum Rating (85°C) | | | | Specifications (25°C) | | | | | |
|-------------|----------|------------------------------|-----------------------|--------------------|-----------------------|-----------------------------|---|-------------------------|--|-----------------|---------------------------------|--|
| | | | Continuous | | Transient | | Varistor Voltage at 1mA DC Test Current | | Maximum Clamping Voltage 8 x 20µs | | Typical Capacitance f = 1MHz | |
| | | | V _{RMS} | V _{DC} | Energy 10 x 1000µs | Peak Current 8 x 20µs | | | | | | |
| | | | V _{M(AC)} | V _{M(DC)} | W _{TM} | I _{TM} | V _{NOM} Min | V _{NOM} Max | V _C | I _{PK} | C | |
| (V) | (V) | (J) | (A) | (V) | (V) | (V) | (A) | (pF) | | | | |
| V8ZA05P | PZ08 | 5 | 4 | 5.5 | 0.1 | 50 | 6 | 11 | 30 | 1 | 2000 | |
| V8ZA1P | P08Z1 | 7 | 4 | 5.5 | 0.4 | 100 | 6 | 11 | 22 | 2.5 | 4190 | |
| V8ZA2P | P08Z2 | 10 | 4 | 5.5 | 0.8 | 250 | 6 | 11 | 20 | 5 | 7000 | |
| V12ZA05P | PZ12 | 5 | 6 | 8 | 0.14 | 50 | 9 | 16 | 37 | 1 | 1700 | |
| V12ZA1P | P12Z1 | 7 | 6 | 8 | 0.6 | 100 | 9 | 16 | 34 | 2.5 | 3350 | |
| V12ZA2P | P12Z2 | 10 | 6 | 8 | 1.2 | 250 | 9 | 16 | 30 | 5 | 6100 | |
| V18ZA05P | PZ18 | 5 | 10 | 14 | 0.17 | 100 | 16.2 | 19.8 | 36 | 1 | 1400 | |
| V18ZA1P | P18Z1 | 7 | 10 | 14 | 0.8 | 250 | 16.2 | 19.8 | 36 | 2.5 | 2700 | |
| V18ZA2P | P18Z2 | 10 | 10 | 14 | 1.5 | 500 | 16.2 | 19.8 | 36 | 5 | 5300 | |
| V18ZA3P | P18Z3 | 14 | 10 | 14 | 3.5 | 1000 | 16.2 | 19.8 | 36 | 10 | 18870 | |
| V18ZA20P | P18Z20 | 20 | 10 | 14 | 10 | 2000 | 16.2 | 19.8 | 37 | 20 | 22000 | |
| V18ZA40P | P18Z40 | 20 | 10 | 14 | 80 (Note 2) | 2000 | 16.2 (Note 3) | 19.8 | 37 | 20 | 22000 | |
| V22ZA05P | PZ22 | 5 | 14 | 18 | 0.2 | 100 | 19.8 | 24.2 | 43 | 1 | 1220 | |
| V22ZA1P | P22Z1 | 7 | 14 | 18 | 0.9 | 250 | 19.8 | 24.2 | 43 | 2.5 | 2375 | |
| V22ZA2P | P22Z2 | 10 | 14 | 18 | 2 | 500 | 19.8 | 24.2 | 43 | 5 | 4500 | |
| V22ZA3P | P22Z3 | 14 | 14 | 18 | 4 | 1000 | 19.8 | 24.2 | 43 | 10 | 14730 | |
| V24ZA20P | P24Z20 | 20 | 14 | 18 | 12 | 2000 | 19.8 | 24.2 | 43 | 20 | 18000 | |
| V24ZA50P | P24Z50 | 20 | 14 | 18 (Note 4) | 100 (Note 2) | 2000 | 20.7 (Note 3) | 25.3 | 43 | 20 | 18000 | |
| V27ZA05P | PZ27 | 5 | 17 | 22 | 0.25 | 100 | 24.3 | 29.7 | 53 | 1 | 920 | |
| V27ZA1P | P27Z1 | 7 | 17 | 22 | 1 | 250 | 24.3 | 29.7 | 53 | 2.5 | 1875 | |
| V27ZA2P | P27Z2 | 10 | 17 | 22 | 2.5 | 500 | 24.3 | 29.7 | 53 | 5 | 3850 | |
| V27ZA4P | P27Z4 | 14 | 17 | 22 | 5 | 1000 | 24.3 | 29.7 | 53 | 10 | 11480 | |
| V27ZA20P | P27Z20 | 20 | 17 | 22 | 14 | 2000 | 24.3 | 29.7 | 53 | 20 | 13000 | |
| V27ZA60P | P27Z60 | 20 | 17 | 22 | 100 (Note 2) | 2000 | 24.3 (Note 3) | 29.7 | 50 | 20 | 13000 | |
| V33ZA05P | PZ33 | 5 | 20 | 26 | 0.3 | 100 | 29.7 | 36.3 | 65 | 1 | 790 | |
| V33ZA1P | P33Z1 | 7 | 20 | 26 | 1.2 | 250 | 29.7 | 36.3 | 65 | 2.5 | 1620 | |
| V33ZA2P | P33Z2 | 10 | 20 | 26 | 3 | 500 | 29.7 | 36.3 | 65 | 5 | 3495 | |
| V33ZA5P | P33Z5 | 14 | 20 | 26 | 6 | 1000 | 29.7 | 36.3 | 65 | 10 | 9290 | |
| V33ZA20P | P33Z20 | 20 | 20 | 26 | 18 | 2000 | 29.7 | 36.3 | 65 | 20 | 13000 | |
| V33ZA70P | P33Z70 | 20 | 21 | 27 | 100 (Note 2) | 2000 | 29.7 (Note 3) | 36.3 | 58 | 20 | 13000 | |
| V36ZA20P | P36Z20 | 20 | 23 | 28 | 20 | 2000 | 32.4 | 39.6 | 70 | 20 | 12000 | |
| V36ZA80P | P36Z80 | 20 | 23 | 28 | 100 (Note 2) | 2000 | 32.4 (Note 3) | 39.6 | 63 | 20 | 12000 | |
| V39ZA05P | PZ39 | 5 | 25 | 31 | 0.3 | 100 | 35.1 | 42.9 | 79 | 1 | 675 | |
| V39ZA1P | P39Z1 | 7 | 25 | 31 | 1.2 | 250 | 35.1 | 42.9 | 79 | 2.5 | 1350 | |
| V39ZA3P | P39Z3 | 10 | 25 | 31 | 3 | 500 | 35.1 | 42.9 | 76 | 5 | 3100 | |
| V39ZA6P | P39Z6 | 14 | 25 | 31 | 7.2 | 1000 | 35.1 | 42.9 | 76 | 10 | 7000 | |
| V39ZA20P | P39Z20 | 20 | 25 | 31 | 20 | 2000 | 35.1 | 42.9 | 76 | 20 | 12000 | |
| V47ZA05P | PZ47 | 5 | 30 | 38 | 0.4 | 100 | 42.3 | 51.7 | 93 | 1 | 585 | |
| V47ZA1P | P47Z1 | 7 | 30 | 38 | 1.8 | 250 | 42.3 | 51.7 | 93 | 2.5 | 1245 | |
| V47ZA3P | P47Z3 | 10 | 30 | 38 | 4.5 | 500 | 42.3 | 51.7 | 93 | 5 | 2590 | |
| V47ZA7P | P47Z7 | 14 | 30 | 38 | 8.8 | 1000 | 42.3 | 51.7 | 93 | 10 | 6270 | |
| V47ZA20P | P47Z20 | 20 | 30 | 38 (Note 6) | 23 (Note 7) | 2000 | 42.3 | 51.7 | 93 | 20 | 11000 | |

ZA Series Ratings & Specifications (Continued...)

| Part Number | Branding | Model Size Disc Dia. (mm) | Maximum Rating (85°C) | | | | Specifications (25°C) | | | | |
|-------------|----------|------------------------------|-----------------------|--------------------|-----------------------|-----------------------------|---|-------------------------|--|-----------------|---|
| | | | Continuous | | Transient | | Varistor Voltage at 1mA DC Test Current | | Maximum Clamping Voltage 8 x 20µs | | Typical Capaci- tance f = 1MHz |
| | | | V _{RMS} | V _{DC} | Energy 10 x 1000µs | Peak Current 8 x 20µs | | | | | |
| | | | V _{M(AC)} | V _{M(DC)} | W _{TM} | I _{TM} | V _{NOM} Min | V _{NOM} Max | V _C | I _{PK} | C |
| (V) | (V) | (J) | (A) | (V) | (V) | (V) | (A) | (pF) | | | |
| V56ZA05P | PZ56 | 5 | 35 | 45 | 0.5 | 100 | 50.4 | 61.6 | 110 | 1 | 500 |
| V56ZA2P | P56Z2 | 7 | 35 | 45 | 2.3 | 250 | 50.4 | 61.6 | 110 | 2.5 | 1035 |
| V56ZA3P | P56Z3 | 10 | 35 | 45 | 5.5 | 500 | 50.4 | 61.6 | 110 | 5 | 2150 |
| V56ZA8P | P56Z8 | 14 | 35 | 45 | 10 | 1000 | 50.4 | 61.6 | 110 | 10 | 4840 |
| V56ZA20P | P56Z20 | 20 | 35 | 45 | 30 | 2000 | 50.4 | 61.6 | 110 | 20 | 10000 |
| V68ZA05P | PZ68 | 5 | 40 | 56 | 0.6 | 100 | 61.2 | 74.8 | 135 | 1 | 400 |
| V68ZA2P | P68Z2 | 7 | 40 | 56 | 3 | 250 | 61.2 | 74.8 | 135 | 2.5 | 910 |
| V68ZA3P | P68Z3 | 10 | 40 | 56 | 6.5 | 500 | 61.2 | 74.8 | 135 | 5 | 1850 |
| V68ZA10P | P68Z10 | 14 | 40 | 56 | 13 | 1000 | 61.2 | 74.8 | 135 | 10 | 3870 |
| V68ZA20P | P68Z20 | 20 | 40 | 56 | 33 | 2000 | 61.2 | 74.8 | 135 | 20 | 9000 |
| V82ZA05P | PZ82 | 5 | 50 | 68 | 2 | 400 | 73.8 | 90.2 | 135 | 5 | 355 |
| V82ZA2P | P82Z2 | 7 | 50 | 68 | 4 | 1200 | 73.8 | 90.2 | 135 | 10 | 700 |
| V82ZA4P | P82Z4 | 10 | 50 | 68 | 8 | 2500 | 73.8 | 90.2 | 135 | 25 | 1485 |
| V82ZA12P | P82Z12 | 14 | 50 | 68 | 15 | 4500 | 73.8 | 90.2 | 145 | 50 | 3380 |
| V82ZA20P | P82Z20 | 20 | 50 | 68 | 25 | 6500 | 73.8 | 90.2 | 145 | 100 | 7000 |
| V100ZA05P | PZ100 | 5 | 60 | 81 | 2.5 | 400 | 90 | 110 | 165 | 5 | 310 |
| V100ZA3P | P100Z | 7 | 60 | 81 | 5 | 1200 | 90 | 110 | 165 | 10 | 600 |
| V100ZA4P | P100Z4 | 10 | 60 | 81 | 10 | 2500 | 90 | 110 | 165 | 25 | 1200 |
| V100ZA15P | P100Z15 | 14 | 60 | 81 | 20 | 4500 | 90 | 110 | 175 | 50 | 2900 |
| V100ZA20P | P100Z20 | 20 | 60 | 81 | 30 | 6500 | 90 | 110 | 175 | 100 | 6500 |
| V120ZA05P | PZ120 | 5 | 75 | 102 | 3 | 400 | 108 | 132 | 205 | 5 | 250 |
| V120ZA1P | P120Z | 7 | 75 | 102 | 6 | 1200 | 108 | 132 | 205 | 10 | 515 |
| V120ZA4P | P120Z4 | 10 | 75 | 102 | 12 | 2500 | 108 | 132 | 200 | 25 | 1100 |
| V120ZA6P | P120Z6 | 14 | 75 | 102 | 22 | 4500 | 108 | 132 | 210 | 50 | 2450 |
| V120ZA20P | P120Z20 | 20 | 75 | 102 | 33 | 6500 | 108 | 132 | 210 | 100 | 5000 |
| V150ZA05P | PZ150 | 5 | 92 | 127 | 4 | 400 | 135 | 165 | 250 | 5 | 190 |
| V150ZA1P | PZ051 | 7 | 95 | 127 | 8 | 1200 | 135 | 165 | 250 | 10 | 460 |
| V150ZA4P | P150Z4 | 10 | 95 | 127 | 15 | 2500 | 135 | 165 | 250 | 25 | 860 |
| V150ZA8P | P150Z8 | 14 | 95 | 127 | 20 | 4500 | 135 | 165 | 250 | 50 | 1910 |
| V150ZA20P | P150Z20 | 20 | 95 | 127 | 45 | 6500 | 135 | 165 | 250 | 100 | 3500 |
| V180ZA05P | PZ180 | 5 | 110 | 153 | 5 | 400 | 162 | 198 | 295 | 5 | 100 |
| V180ZA1P | P180Z | 7 | 115 | 153 | 10 | 1200 | 162 | 198 | 300 | 10 | 320 |
| V180ZA5P | P180Z5 | 10 | 115 | 153 | 18 | 2500 | 162 | 198 | 300 | 25 | 465 |
| V180ZA10P | P180Z10 | 14 | 115 | 153 | 35 | 4500 | 162 | 198 | 300 | 50 | 1190 |
| V180ZA20P | P180Z20 | 20 | 115 | 153 | 52 | 6500 | 162 | 198 | 300 | 100 | 2400 |
| V205ZA05P | PZ205 | 5 | 130 | 170 | 5.5 | 400 | 184.5 | 225.5 | 340 | 5 | 100 |
| V220ZA05P | PZ220 | 5 | 140 | 180 | 6 | 400 | 198 | 242 | 360 | 5 | 95 |
| *V240ZA05P | PZ240 | 5 | 150 | 200 | 7 | 400 | 216 | 264 | 395 | 5 | 90 |
| *V270ZA05P | PZ270 | 5 | 175 | 225 | 7.5 | 400 | 243 | 297 | 455 | 5 | 75 |
| *V330ZA05P | PZ330 | 5 | 210 | 275 | 9 | 400 | 306 | 374 | 540 | 5 | 70 |
| *V360ZA05P | PZ360 | 5 | 230 | 300 | 9.5 | 400 | 324 | 396 | 595 | 5 | 60 |
| *V390ZA05P | PZ390 | 5 | 250 | 330 | 10 | 400 | 351 | 429 | 650 | 5 | 80 |
| *V430ZA05P | PZ430 | 5 | 275 | 369 | 11 | 400 | 387 | 473 | 710 | 5 | 75 |
| *V470ZA05P | PZ470 | 5 | 300 | 385 | 12 | 400 | 423 | 517 | 775 | 5 | 70 |
| *V620ZA05P | PZ620 | 5 | 385 | 505 | 13 | 400 | 558 | 682 | 1025 | 5 | 45 |
| *V680ZA05P | PZ680 | 5 | 420 | 560 | 14 | 400 | 612 | 748 | 1120 | 5 | 40 |
| *V715ZA05P | PZ715 | 5 | 440 | 585 | 15.5 | 400 | 643.5 | 786.5 | 1180 | 5 | 35 |
| *V750ZA05P | PZ750 | 5 | 460 | 615 | 17 | 400 | 675 | 825 | 1240 | 5 | 30 |

- Note:
- Average power dissipation of transients not to exceed 0.2W, 0.25W, 0.4W, 0.6W or 1W for model sizes 5mm, 7mm, 10mm, 14mm and 20mm, respectively.
 - Energy rating (auto load dump) for impulse duration of 40ms minimum to one half of peak current, 60 sec interval (ISO 7637-2 pulse 5a and ISO 16750-2 Table 5A)
 - 10mA DC test current.
 - Also rated to withstand 24V for 5 minutes.
 - Higher voltages available, contact Littelfuse.
 - Also rated to withstand 48V for 5 minutes.
 - Energy rating for impulse duration of 30ms minimum to one half of peak current (Auto Load Dump): 100J
 - The typical capacitance rating is the discrete component test result.
- † Also Recognized to UL 1449, Transient Voltage Surge Suppressors File E320116

Phenolic Coating Option -- ZA Series Varistors for Hi-Temperature Operating Conditions:

- Phenolic coated ZA Series devices are available with improved maximum operating temperature of 125°C
- These devices also have improved temperature cycling performance capability
- Ratings and specifications are as per standard ZA Series except Hi-Pot Encapsulation (Isolation Voltage Capability) = 500V
- To order: add 'X1347' to part number (e.g. V22ZA3PX1347)
- These devices are not UL, VDE or CECC certified
- Contact factory for further details
- Product marking:



Copper Electrode Option:

- Add 'W' to the end of the part number (e.g. V240ZA05PW)
- Copper electrode option is only available for V240~V750 for ZA series.
- Product marking:



Current Energy and Power Dissipation Ratings

Should transients occur in rapid succession, the average power dissipation is the energy (watt-seconds) per pulse times the number of pulses per second. The power so developed must be within the specifications shown on the Device Ratings and Specifications Table for the specific

device. The operating values of a MOV need to be derated at high temperatures as shown above. Because varistors only dissipate a relatively small amount of average power they are not suitable for repetitive applications that involve substantial amounts of average power dissipation.

Figure 1A - Power Derating for Epoxy Coated



Figure 1B - Power Derating for Phenolic Coated



Peak Pulse Current Test Waveform



O_1 = Virtual Origin of Wave
 T = Time from 10% to 90% of Peak
 T_1 = Rise Time = $1.25 \times T$
 T_2 = Decay Time

Example - For an $8/20 \mu s$ Current Waveform:

$8 \mu s = T_1 = \text{Rise Time}$

$20 \mu s = T_2 = \text{Decay Time}$

Maximum Clamping Voltage for 5mm Parts

V8ZA05(P) - V68ZA05(P)



V82ZA05(P) - V330ZA05(P)



V360ZA05(P) - V750ZA05(P)



Maximum Clamping Voltage for 7mm Parts

V8ZA1(P) - V68ZA2(P)



V82ZA2(P) - V180ZA1(P)



Maximum Clamping Voltage for 10mm Parts

V8ZA2(P) - V68ZA3(P)



Figure 8

V82ZA4(P) - V180ZA5(P)



Figure 9

Maximum Clamping Voltage for 14mm Parts

V18ZA3(P) - V68ZA10(P)



Figure 10

V82ZA12(P) - V180ZA10(P)



Figure 11

Maximum Clamping Voltage for 20mm Parts

V18ZA20(P) - V36ZA80(P)



V39ZA20(P) - V180ZA20(P)

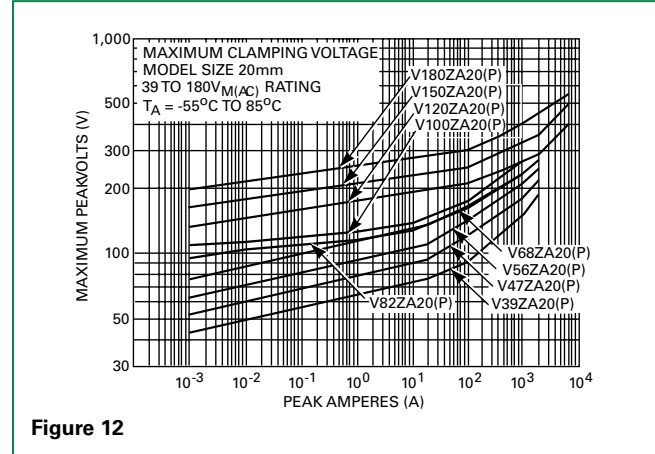

Repetitive Surge Capability for 5mm Parts

V8ZA05P - V12ZA05P

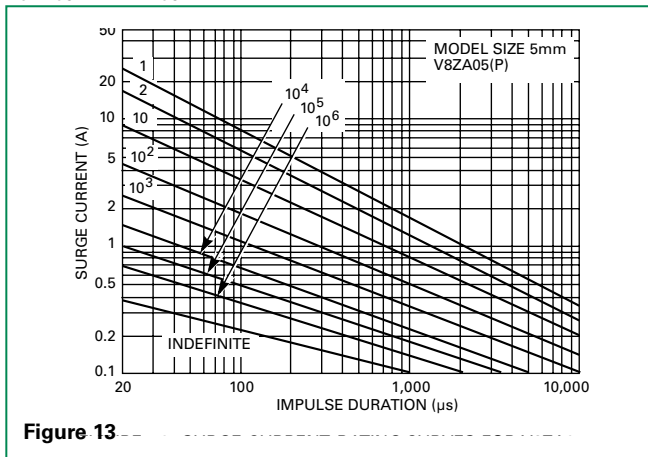

V18ZA05(P) - V68ZA05(P)

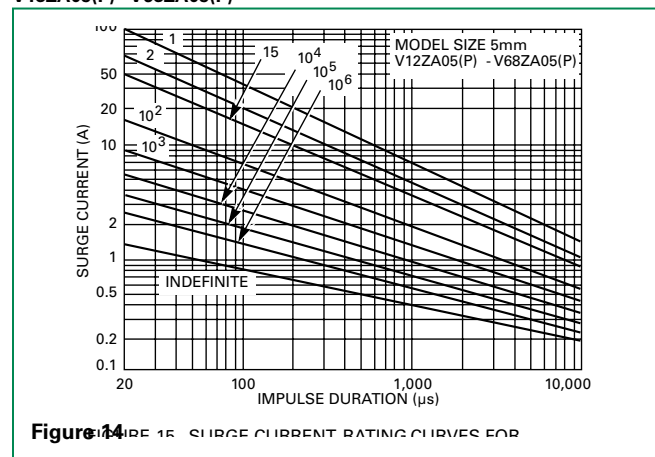

V82ZA05(P) - V750ZA05(P)

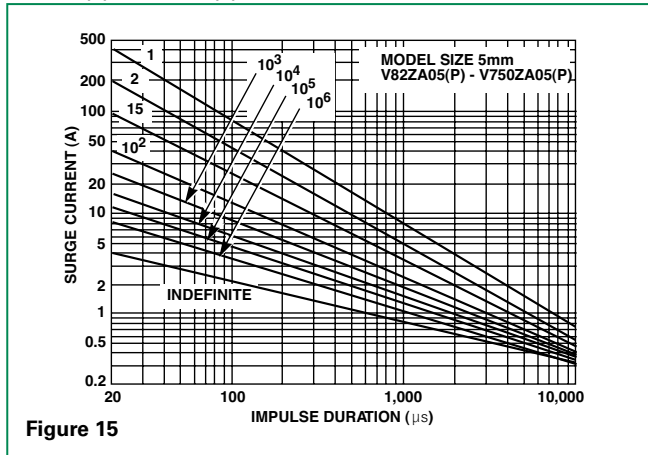

Note: Repetitive surge capability is qualified and tested based on 8/20us current waveform (not combination waveform) and UL1449 40.73 (Edition 4) test condition.

Repetitive Surge Capability for 7mm Parts

V8ZA1(P) - V12ZA1(P)

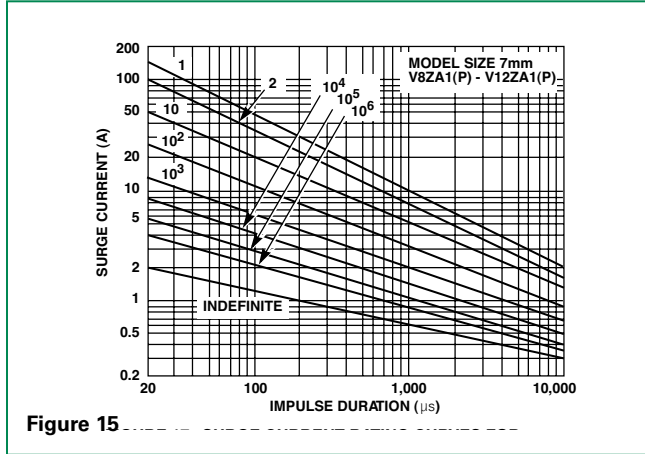

Figure 15

Repetitive Surge Capability for 10mm Parts

V8ZA2(P) - V12ZA2(P)

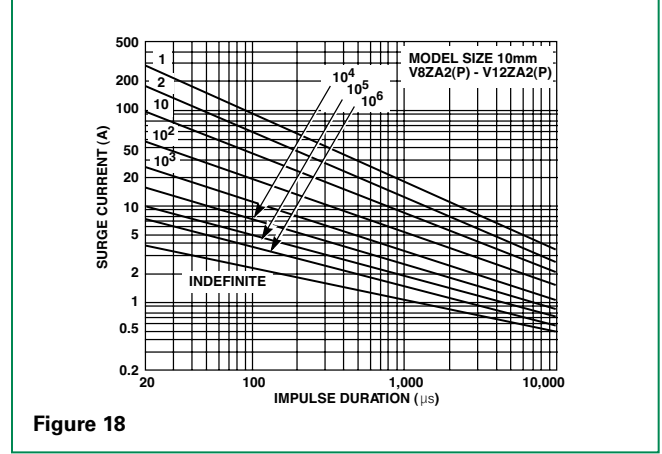

Figure 18

V18ZA1(P) - V68ZA2(P)

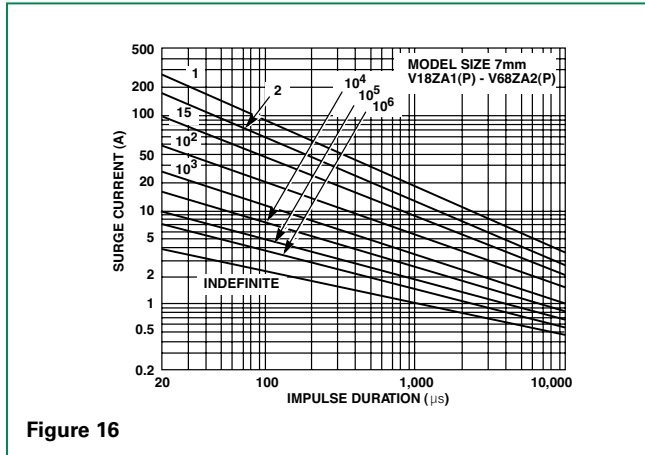

Figure 16

V18ZA2(P) - V68ZA3(P)

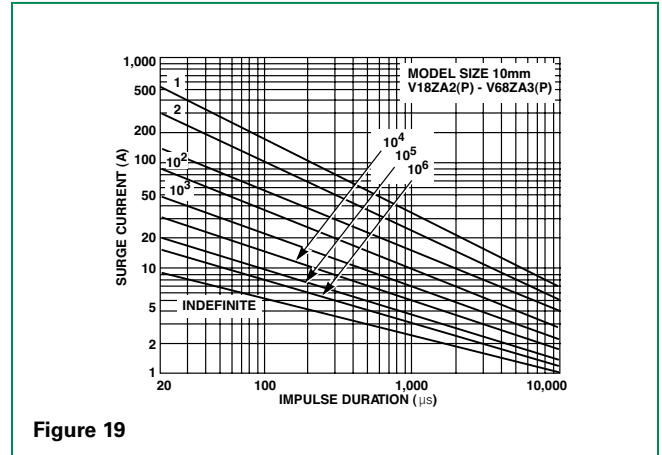

Figure 19

V82ZA2(P) - V180ZA1(P)

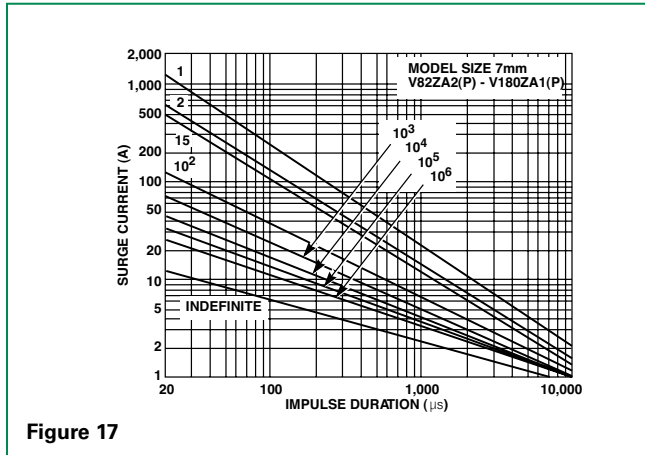

Figure 17

V82ZA4(P) - V180ZA5(P)

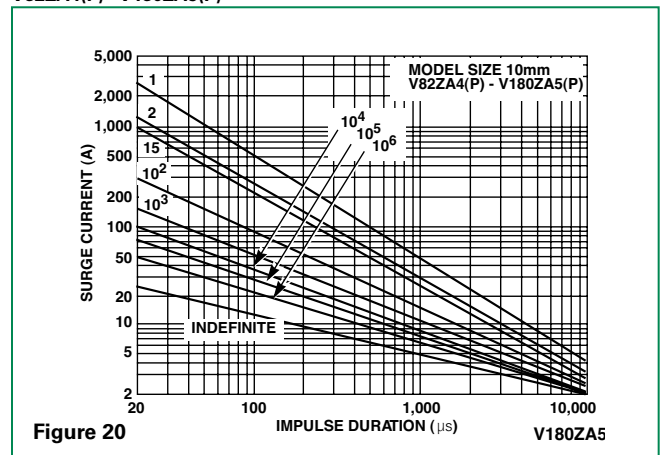

Figure 20

Note: Repetitive surge capability is qualified and tested based on 8/20us current waveform (not combination waveform) and UL1449 40.7.3 (Edition 4) test condition.

Repetitive Surge Capability for 14mm Parts

V18ZA3(P) - V68ZA10(P)

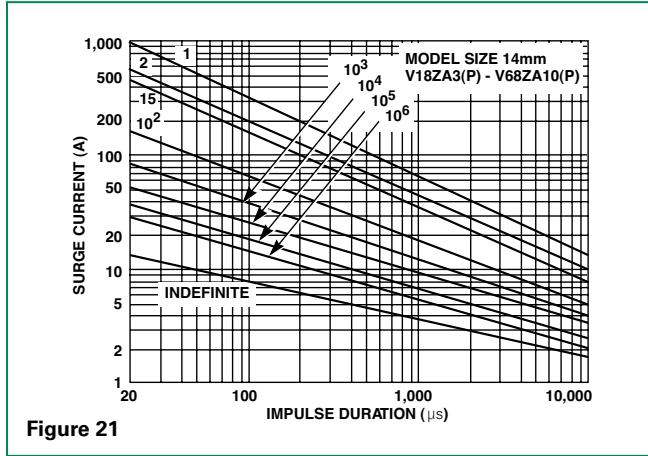

Figure 21

V82ZA12(P) - V180ZA10(P)

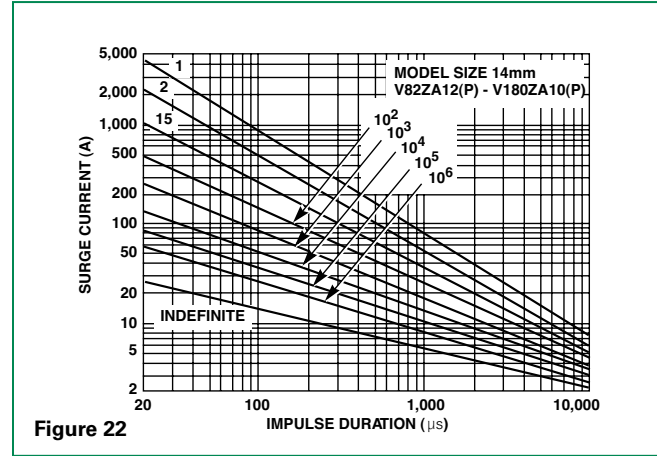

Figure 22

Repetitive Surge Capability for 20mm Parts

V18ZA40(P) - V68ZA20(P)

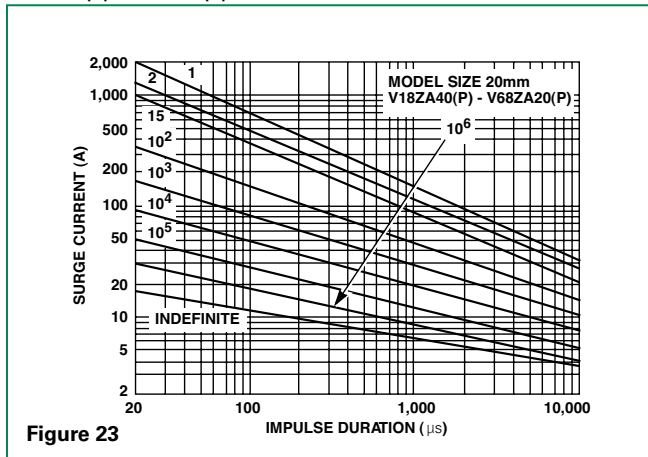

Figure 23

V82ZA20(P) - V180ZA20(P)

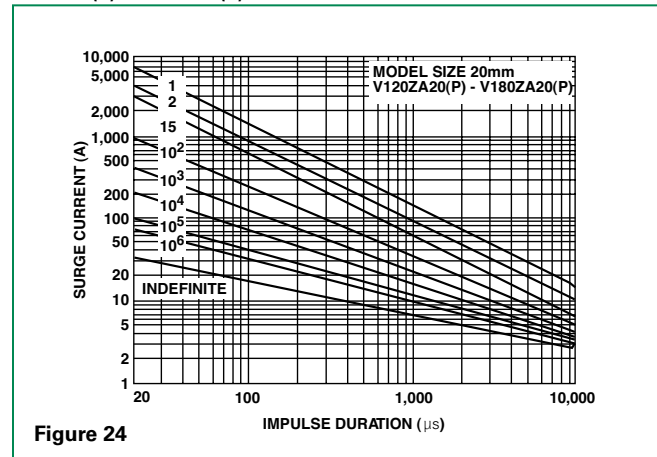

Figure 24

NOTE: If pulse ratings are exceeded, a shift of V_{NIDC} (at specified current) of more than +/-10% could result. This type of shift, which normally results in a decrease of V_{NIDC} , may result in the device not meeting the original published specifications, but does not prevent the device from continuing to function, and to provide ample protection.

Note: Repetitive surge capability is qualified and tested based on 8/20us current waveform (not combination waveform) and UL1449 40.73 (Edition 4) test condition.

Wave Solder Profile

Non Lead-free Profile



Lead-free Profile



Physical Specifications

| | |
|----------------------------------|---|
| Lead Material | Copper Clad Steel Wire |
| Soldering Characteristics | Solderability per MIL-STD-202, Method 208 |
| Insulating Material | Cured, flame retardant epoxy polymer meets UL94V-0 requirements |
| Device Labeling | Marked with LF, voltage, UL/CSA logos, and date code |

Environmental Specifications

| | |
|--|--|
| Operating Ambient Temperature Range | -55°C to +85°C |
| Storage Temperature Range | -55°C to +125°C |
| Humidity Aging | +85°C, 85% RH, 1000 hours +/-10% typical voltage change |
| Thermal Shock | +85°C to -40°C 5 times +/-10% typical voltage change |
| Solvent Resistance | MIL-STD-202, Method 215 |
| Moisture Sensitivity | Level 1, J-STD-020 |

Product Dimensions (mm)



CRIMPED AND TRIMMED LEAD

Radial lead types can be supplied with combination preformed crimp and trimmed leads. This option is supplied to the dimensions shown.

*Seating plane interpretation per IEC-717

To order this crimped and trimmed lead style, standard radial type model numbers are changed by replacing the model letter "ZA" with "ZC." This option is supplied in bulk only.

Example:

| Standard Model | Order As |
|----------------|----------|
| V18ZA3P | V18ZC3P |

For crimped leads without trimming and any variations to the above, contact Littelfuse.

| Dimension | V _{RMS} Voltage Model | 5mm Size | | 7mm Size | | 10mm Size | | 14mm Size | | 20mm Size | |
|-------------------------------|--------------------------------|---------------|---------------|---------------|---------------|--------------|--------------|--------------|--------------|-------------------------------|-------------------------------|
| | | Min. mm (in) | Max. mm (in) | Min. mm (in) | Max. mm (in) | Min. mm (in) | Max. mm (in) | Min. mm (in) | Max. mm (in) | Min. mm (in) | Max. mm (in) |
| A | All | - | 10 (0.394) | - | 12 (0.472) | - | 16 (0.630) | - | 20 (0.787) | - | 26.5 (1.043) |
| ØD | All | - | 7 (0.276) | - | 9 (0.354) | - | 12.5 (0.492) | - | 17 (0.669) | - | 23 (0.906) |
| e (see notes below) | All | 4 (0.157) | 6 (0.236) | 4 (0.157) | 6 (0.236) | 6.5 (0.256) | 8.5 (0.335) | 6.5 (0.256) | 8.5 (0.335) | 6.5 (0.256) (note 1 below) | 8.5 (0.335) (note 1 below) |
| e₁ | V8ZA-V56ZA | 1 (0.039) | 3 (0.118) | 1 (0.039) | 3 (0.118) | 1 (0.039) | 3 (0.118) | 1 (0.039) | 3 (0.118) | 1 (0.039) | 3 (0.118) |
| | V68ZA-V100ZA | 1.5 (0.059) | 3.5 (0.138) | 1.5 (0.059) | 3.5 (0.138) | 1.5 (0.059) | 3.5 (0.138) | 1.5 (0.059) | 3.5 (0.138) | 1.5 (0.059) | 3.5 (0.138) |
| | V120ZA-V180ZA | 1 (0.039) | 3 (0.118) | 1 (0.039) | 3 (0.118) | 1 (0.039) | 3 (0.118) | 1 (0.038) | 3 (0.118) | 1 (0.038) | 3 (0.118) |
| | V205ZA-V750ZA | 1.5 (0.059) | 3.5 (0.138) | - | - | - | - | - | - | - | - |
| E | V8ZA-V56ZA | - | 5 (0.197) | - | 5 (0.197) | - | 5 (0.197) | - | 5 (0.197) | - | 5 (0.197) |
| | V68ZA-V100ZA | - | 5.6 (0.220) | - | 5.6 (0.220) | - | 5.6 (0.220) | - | 5.6 (0.220) | - | 5.6 (0.220) |
| | V120ZA-V180ZA | - | 5 (0.197) | - | 5 (0.197) | - | 5 (0.197) | - | 5 (0.197) | - | 5 (0.197) |
| | V205ZA-V750ZA | - | 5.6 (0.220) | - | - | - | - | - | - | - | - |
| øb | All | 0.585 (0.023) | 0.685 (0.027) | 0.585 (0.023) | 0.685 (0.027) | 0.76 (0.030) | 0.86 (0.034) | 0.76 (0.030) | 0.86 (0.034) | 0.76 (0.030) | 0.86 (0.034) |
| A_{TRIM} | All | - | 13.0 (0.512) | - | 15 (0.591) | - | 19.5 (0.768) | - | 22.5 (0.886) | - | 29.0 (1.142) |
| L_{TRIM} | All | 2.41 (0.095) | 4.69 (0.185) | 2.41 (0.095) | 4.69 (0.185) | 2.41 (0.095) | 4.69 (0.185) | 2.41 (0.095) | 4.69 (0.185) | 2.41 (0.095) | 4.69 (0.185) |

NOTES: Dimensions in millimeters, inches in parentheses.

1. For 20mm size devices, a 10mm "e" dimension option is also available. Please refer to "Ordering Notes" section "X10" option code for additional information.

2. V24ZA50(P) and V24ZC50(P) only supplied with lead spacing of 6.35mm +/-0.5mm (0.25 +/-0.0196) Dimension e = 5.85 min. Does not apply to Tape and Reel parts.

Tape and Reel Specifications

5 and 7mm Devices



10, 14 and 20mm Devices



Refer to next page for dimension measurement specifics.

Tape and Reel Specifications (continued)

NOTES:

- Radial devices on tape are supplied with crimped leads, straight leads, or under-crimped leads
- Leads are offset by product dimension e1
- Conforms to ANSI and EIA specifications
- Can be supplied to IEC Publication 286-2
- 5mm parts are available on tape and reel up to 385 VAC only

| SYMBOL | DESCRIPTION | MODEL SIZE | | | | |
|----------------------|---|-------------------|-------------------|-------------------|-------------------|-------------------|
| | | 5mm | 7mm | 10mm | 14mm | 20mm |
| P | Pitch of Component | 12.7 +/- 1.0 | 12.7 +/- 1.0 | 25.4 +/- 1.0 | 25.4 +/- 1.0 | 25.4 +/- 1.0 |
| P₀ | Feed Hole Pitch | 12.7 +/- 0.2 | 12.7 +/- 0.2 | 12.7 +/- 0.2 | 12.7 +/- 0.2 | 12.7 +/- 0.2 |
| P₁ | Feed Hole Center to Pitch | 3.85 +/- 0.7 | 3.85 +/- 0.7 | 8.85 +/- 0.7 | 8.85 +/- 0.7 | 8.85 +/- 0.7 |
| P₂ | Hole Center to Component Center | 6.35 +/- 1.0 | 6.35 +/- 1.0 | 12.7 +/- 0.7 | 12.7 +/- 0.7 | 12.7 +/- 0.7 |
| F | Lead to Lead Distance | 5.0 +/- 1.0 | 5.0 +/- 1.0 | 7.5 +/- 1.0 | 7.5 +/- 1.0 | 7.5 +/- 1.0 |
| h | Component Alignment | 2.0 Max | 2.0 Max | 2.0 Max | 2.0 Max | 2.0 Max |
| W | Tape Width | 18.0 +1.0 / -0.5 | 18.0 +1.0 / -0.5 | 18.0 +1.0 / -0.5 | 18.0 +1.0 / -0.5 | 18.0 +1.0 / -0.5 |
| W₀ | Hold Down Tape Width | 12.0 +/- 0.3 | 12.0 +/- 0.3 | 12.0 +/- 0.3 | 12.0 +/- 0.3 | 12.0 +/- 0.3 |
| W₁ | Hole Position | 9.0 +0.75 / -0.50 | 9.0 +0.75 / -0.50 | 9.0 +0.75 / -0.50 | 9.0 +0.75 / -0.50 | 9.0 +0.75 / -0.50 |
| W₂ | Hold Down Tape Position | 0.5 Max | 0.5 Max | 0.5 Max | 0.5 Max | 0.5 Max |
| H | Height from Tape Center to Component Base | 18.0 +2.0 / -0.0 | 18.0 +2.0 / -0.0 | 18.0 +2.0 / -0.0 | 18.0 +2.0 / -0.0 | 18.0 +2.0 / -0.0 |
| H₀ | Seating Plane Height | 16.0 +/- 0.5 | 16.0 +/- 0.5 | 16.0 +/- 0.5 | 16.0 +/- 0.5 | 16.0 +/- 0.5 |
| H₁ | Component Height | 29.0 Max | 32.0 Max | 36.0 Max | 40.0 Max | 46.5 Max |
| D₀ | Feed Hole Diameter | 4.0 +/- 0.2 | 4.0 +/- 0.2 | 4.0 +/- 0.2 | 4.0 +/- 0.2 | 4.0 +/- 0.2 |
| t | Total Tape Thickness | 0.7 +/- 0.2 | 0.7 +/- 0.2 | 0.7 +/- 0.2 | 0.7 +/- 0.2 | 0.7 +/- 0.2 |
| U | Undercrimp Width | 8.0 Max | 8.0 Max | 8.0 Max | 8.0 Max | 8.0 Max |
| p | Component Alignment | 3° Max | 3° Max | 3° Max | 3° Max | 3° Max |

Disclaimer Notice - Information furnished is believed to be accurate and reliable. However, users should independently evaluate the suitability of and test each product selected for their own applications. Littelfuse products are not designed for, and may not be used in, all applications. Read complete Disclaimer Notice at www.littelfuse.com/disclaimer-electronics.