

VEK-H-30320-000
SHT 1.1

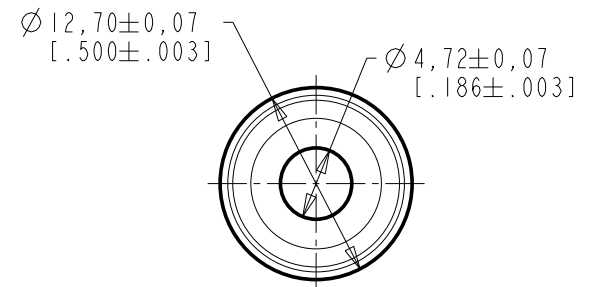
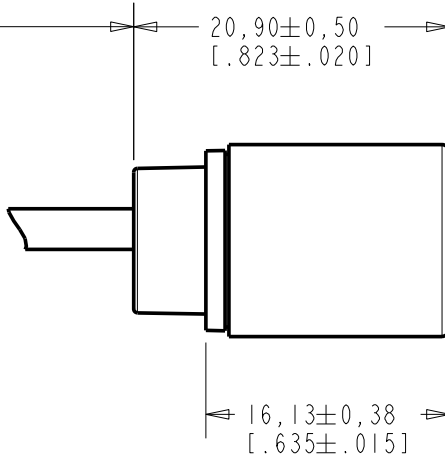
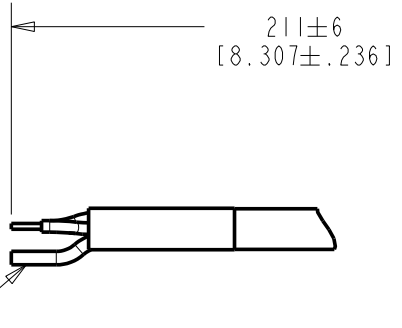
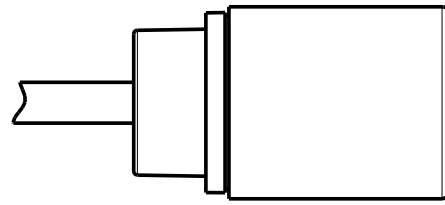
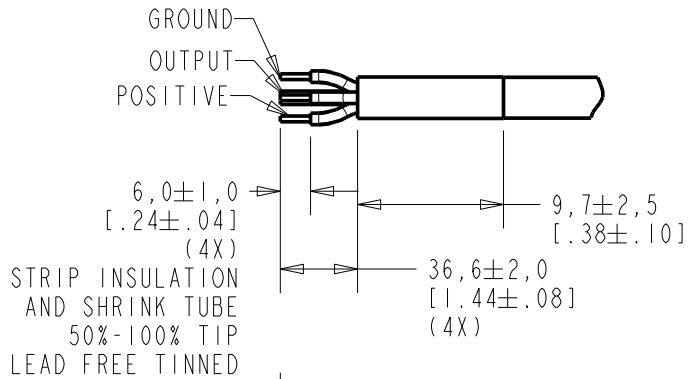

WIRE COLOR				WEIGHT GRAMS
+ve	OUTPUT	-ve	SHIELD	
RED	WHITE	BLACK	HEATSHRINK	4.6

DIMENSIONS IN MILLIMETERS [INCHES]

Revision	C.O. #	Implementation Date	RELEASE LEVEL	REVISION
B	C10107751	8-19-08	Active	B
A	C10107375	7-7-08		

SCALE:	2:1	DR. BY	DATE
DO NOT SCALE DRAWING		TT	7-7-08
TITLE:		CK. BY	DATE
MICROPHONE		GJP	7-15-08
VEK-H-30320-000		APP. BY	DATE
OUTLINE DRAWING		GJP	7-15-08
SHT 1.1			

KNOWLES ELECTRONICS
ITASCA, ILLINOIS U.S.A.

SENSITIVITY IN dB RELATIVE TO 1.0 VOLT/0.1 Pa (N/M²)
FOR CONDITIONS SHOWN BELOW.

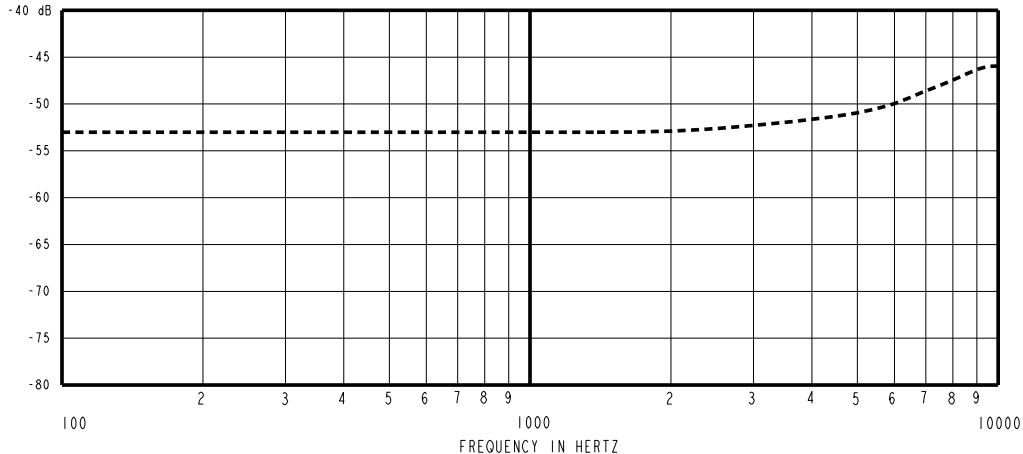

FREQUENCY	SENSITIVITY			DEVICE CONFORMITY	
	MIN.	NOM.	MAX.	RANGE OF DEVIATION FROM 1KHz	
100	---	-53.0	---	-3.0	+3.0
1000	-56.0	-53.0	-50.0	0.0	0.0
10000	---	-46.0	---	+3.0	+11.0

NOTES:

- MICROPHONE TO BE FUNCTIONAL WITH 10 VDC SUPPLY.
- CONFORMS TO REQUIREMENTS SHOWN ON 'ELECTRET MICROPHONE ENVIRONMENTAL QUALIFICATIONS TEST, EK-PA SHEET 2.2' WITH REF. FREQ. 1000 Hz.
- TYPICAL SENSITIVITY TO HUMIDITY AT 1000 Hz IS 0.02 dB/%RH.
- SENSITIVITY AND NOISE VALUES INDICATED ON THIS SPECIFICATION ARE VALID AT 50% HUMIDITY..
- TEST CONDITIONS:
SEAL PRODUCT TO 74 dB SPL SWEPT
SOUND FIELD CREATED BY VOICE APERTURE.
B & K 4227 MOUTH SIMULATOR.
- FOR MICROPHONE CAPSULE SPEC. SEE EK-30436-000

DC SUPPLY	AMPLIFIER CURRENT DRAIN	"A" WEIGHTED NOISE (1 kHz EQUIV. SPL)	OUTPUT IMPEDANCE OHMS		
			MIN.	NOM.	MAX.
9.0V	N/A	26.0 dB MAX.	N/A	N/A	N/A

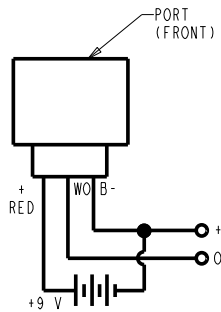

KNOWLES ELECTRONICS
ITASCA, ILLINOIS U.S.A.

Revision	C.O. #	Implementation Date	RELEASE LEVEL	REVISION
B	C10107751	8-19-08	Active	B
A	C10107375	7-7-08		
<small>WHEN TEST LIMITS ARE USED TO ESTABLISH INCOMING INSPECTION ACCEPTANCE/REJECTION CRITERIA, CORRELATION OF TEST EQUIPMENT WITH KNOWLES IS ALSO REQUIRED FOR ELIMINATION OF EQUIPMENT AND TEST METHOD VARIATION</small>				DR. BY: TT DATE: 7-7-08
TITLE: MICROPHONE PERFORMANCE SPECIFICATION			VEK-H-30320-000 SHT 2.1	CK. BY: GJP DATE: 7-15-08 APP. BY: GJP DATE: 7-15-08