

VK Series Dual Function Low Voltage Automotive Grade 125°C

Overview

KEMET's VK series of dual function protective devices protect against voltage surges in a low voltage region and against high frequency noise, replacing two components, those being a low voltage varistor and a capacitor.

KEMET's VK series incorporate a varistor function in the DC voltage range from 3 to 125 V (up to 170 V upon request) and function as high frequency by-pass capacitors operating in the capacitance range from 10 nF to 1 μ F. Lower capacitance values are also available. They are intended for protection of all sensitive electronic devices experiencing both voltage transients and high frequency noise produced by electromechanical devices, such as buzzers, relays, etc.

KEMET's VK series are square shaped components with in-line leads and require at least 30% less mounting space.

Applications

Typical applications include electrostatic surge absorption, relay surge suppression effect and relay reset time, and piezoelectric buzzer shock noise absorption in micro controllers, relays, DC and micro motors, exchangers, phone terminals and antennas as well as automobile electronics including wiper motors, central locking systems, seat adjustment motors, seat heating and electric window systems.

Benefits

- Through-hole form factor
- Operating ambient temperature of -40°C to $+125^{\circ}\text{C}$
- Operating voltage range of 3 to 125 VDC
- Operating voltage range (V_{rms}) 2 V to 95 V
- Capacitance range at 1 kHz of 10 nF to 1 μ F
- Capacitor temperature characteristics X7R
- Dimensional and weight savings on the board
- One standard model size available, 6 x 9 mm
- RoHS 2 2011/65/EC, REACH compliant
- AEC-Q200 qualified Grade 1

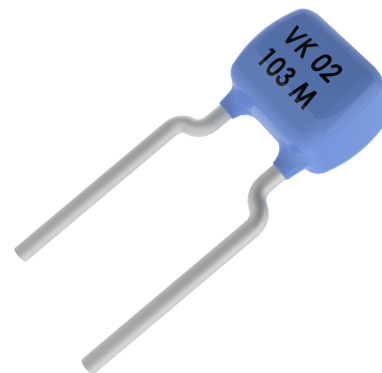

Ordering Information

VK	103	M	M	151	R	002	P050
Series	Capacitance Code (nF)	Capacitance Tolerance Code	Tolerance of Varistor Voltage	Maximum Surge Current Code	Packaging/Lead Style	Maximum Continuous Working Voltage (Vrms AC)	Pitch Code
Varistor Dual Function Leaded 125°C Low Voltage Automotive Grade Varistor/Capacitor (X7R Dielectric)	103 = 10 104 = 100 105 = 1,000	M = ±20%	K = ±10% L = ±15% M = ±20%	151 = 150 A	B = Bulk R = Reel	002 = 2 004 = 4 006 = 6 008 = 8 011 = 11 014 = 14 017 = 17 020 = 20 025 = 25 030 = 30 035 = 35 040 = 40 050 = 50 060 = 60 095 = 95	P050 = 5 mm

Dimensions – Millimeters



As per part number table.

Environmental Compliance

RoHS 2 2011/65/EC, REACH

Performance Characteristics

Continuous	Units	Value
Steady State Applied Voltage		
DC Voltage Range (V_{dc})	V	3 to 125
AC Voltage Range (V_{rms})	V	2 to 95
Transient		
Non-Repetitive Surge Current, 8/20 μ s Waveform (I_{max})	A	150
Non-Repetitive Surge Energy, 10/1000 μ s Waveform (W_{max})	J	0.1 to 2.5
Capacitance Range	nF	10 to 1000
Capacitor Temperature Characteristics		X7R
Operating Ambient Temperature	°C	-40 to +125
Storage Temperature Range	°C	-40 to +150
Threshold Voltage Temperature Coefficient	%/°C	< + 0.05
Insulation Resistance	G Ω	> 1
Isolation Voltage Capability	kV	> 1.25
Response Time	ns	< 25
Climatic Category		40/125/56

Qualifications

Reliability Parameter	Test	Tested According to	Condition to be Satisfied after Testing
Voltage Proof	Vt	EN 132 400, Test 4.2.1. - the voltage shall be raised from near zero to the test voltage Vt at a rate not exceeding 150 V/s, Where for: Class X1 Capacitors Vt = 2*Vrms + 1,500 V~, 1 minute Class Y1 Capacitors Vt = 4000 V~, 1 minute Class Y2 Capacitors Vt = 2*Vrms + 1,500 V~, 1 minute	no permanent breakdown of flash-overs during the test period
Impulse Voltage		EN 132 400, Test 4.13. - 24 impulses of the same polarity shall be applied to the capacitor. The time between impulses shall be no less than 10s, where for: Class X1 Capacitors Vp = 4 kV Class Y1 Capacitors Vp = 8 kV Class Y2 Capacitors Vp = 5 kV	no self-healing breakdowns or flash-overs
AC/DC Bias Reliability	AC/DC Life Test	EN 132 400, Test 4.14, 1000 h at UCT, where: - for X Class Capacitors: at V = 1.25 Vrms and once per hour the voltage shall be increased to 1000 V~ for 0,1 s - for Y Class Capacitors: at V = 1.7 Vrms and once per hour the voltage shall be increased to 1,000 V~ for 0,1 s	no visible damage $ \Delta C/C < 20\%$ $\tan \delta < 0.008$ IR greater than 50 % of the applicable limits no permanent breakdown or flash-over during voltage proof

Qualifications cont'd

Reliability Parameter	Test	Tested According to	Condition to be Satisfied after Testing
Charge and Discharge		EN 132 400, Test 4.15. – 10.000 cycles of charge and discharge at the rate of one operation per minute with the test voltage of $\sqrt{2} \cdot V_{rms}$ discharge rate adjusted to 100 V/ μ s	$ \Delta C/C < 10\%$ $\tan \delta < 0,008$ IR greater than 50 % of the applicable limits
Radio – Frequency Characteristics		EN 132 400, Test 4.16. – measurement of capacitor impedance over a range of frequencies	with specification
Capacitance – Temperature Characteristics		Measurement of capacitance and $\tan \delta$ in the temperature chamber at 20 °C and at UCT and LTC	with specification
Environmental and Storage Reliability	Climatic Sequence	EN 132 400, Test 4.11 a) Dry heat, 16 h, UCT, Test Ba, IEC 68–2–2 b) Damp heat, cyclic, the first cycle: 55°C, 93 % RH, 24 H, test DB, IEC 68–2–1 c) Cold, LCT, 2 h, Test Aa, IEC 68–2–1 d) Damp heat cyclic, remaining 5 cycles: 55°C, 93 % RH, 24 h/cycle, Test Bd, IEC 68–2–30	no visible damage $ \Delta C/C < 20\%$ $\tan \delta < 0.008$ IR greater than 50 % of the applicable limits no permanent breakdown or flash-over during voltage proof
	Thermal Shock	EN 132 400, Test 4.6, Test Na, IEC 68–2–14, 5 cycles UCT/LCT, 30 minutes	no visible damage
	Steady State Damp Heat	EN 132 400, Test 4.6, Test Na, IEC 68–2–14, 5 cycles UCT/LCT, 30 minutes	no visible damage $ \Delta C/C < 20\%$ $\tan \delta < 0.008$ IR greater than 50 % of the applicable limits no permanent breakdown or flash-over during voltage proof
	Storage Test	ICE 68–2–2, Test Ba 1,000 h at maximum storage temperature	no visible damage $ \Delta C/C < 20\%$ $\tan \delta < 0.008$ IR greater than 50 % of the applicable limits no permanent breakdown or flash-over during voltage proof
Mechanical Reliability	Solderability	EN 132 400, Test 4.5., Test Ta, IEC 68–2–20, solder bath and reflow method	Solderable at shipment and after 2 years of storage - limits
	Resistance to Soldering Heat	EN 132 400, Test 4.4., Test Tb, IEC 68–2–20, solder bath and reflow method	no visible damage $ \Delta C/C < 10\%$
	Robustness of Termination	EN 132 400, Test 4.3., Test Ua, IEC 68–2–21	no visible damage
	Vibration	EN 131 400, Test 4.7., Test Fc, IEC 68–2–6, Frequency range 10 to 55 Hz; Amplitude 0.75 mm or 98 m/s ² Total duration 6 h (3 x 2 h); Waveshape – half sine	no visible damage
	Mechanical Shock	EN 132 400, Test 4.9, Test Ea, IEC 68–2–27 Acceleration = 490 m/s ² ; 100 g 6ms and 50 g 11 ms Waveshape – half sine; Number of shocks = 3 x 6	" $ \Delta C/C < 10\%$ $\tan \delta$ within specification no visible damage"

Application Circuits

(A) Eliminating sparks from relay circuits
 (There is no delay in operating time)



(B) Eliminating noise from micro motors



(C) Stabilizing voltages and absorbing line surges



(D) Absorbing shock noise of piezoelectric alarms



Application Circuits (cont'd)

(E) Protecting semi conductive components including transistors and diodes



(F) Improved thyristor configuration
Eliminating vibration better than conventional circuit



(G) Elimination of over-shooting from transistors



(H) Elimination of static electricity from circuits



Table 1 – Ratings & Part Number Reference

Kemet Part Number	D _{max} (mm)	A _{max} (mm)	R (mm)	d (mm)	t _{max} (mm)	V _{rms}	VDC	V _n 1 mA	V _c at 1A	W _{max} 10/1000 μs (J)	P _{max} (W)	I _{max} 8/20 μs (A)	C at 1 kHz (nF)
VK103MM151(1)002P050	6	9	5	0.6	5.5	2	3	4	10	0.1	0.01	150	10
VK104MM151(1)002P050	6	9	5	0.6	5.5	2	3	4	10	0.1	0.01	150	100
VK105MM151(1)002P050	6	9	5	0.6	5.5	2	3	4	10	0.1	0.01	150	1000
VK103MM151(1)004P050	6	9	5	0.6	5.5	4	5.5	8	14	0.2	0.01	150	10
VK104MM151(1)004P050	6	9	5	0.6	5.5	4	5.5	8	14	0.2	0.01	150	100
VK105MM151(1)004P050	6	9	5	0.6	5.5	4	5.5	8	14	0.2	0.01	150	1000
VK103MM151(1)006P050	6	9	5	0.6	5.5	6	8	11	21	0.2	0.01	150	10
VK104MM151(1)006P050	6	9	5	0.6	5.5	6	8	11	21	0.2	0.01	150	100
VK105MM151(1)006P050	6	9	5	0.6	5.5	6	8	11	21	0.2	0.01	150	1000
VK103ML151(1)008P050	6	9	5	0.6	5.5	8	11	15	25	0.3	0.01	150	10
VK104ML151(1)008P050	6	9	5	0.6	5.5	8	11	15	25	0.3	0.01	150	100
VK105ML151(1)008P050	6	9	5	0.6	5.5	8	11	15	25	0.3	0.01	150	1000
VK103MK151(1)011P050	6	9	5	0.6	5.5	11	14	18	35	0.8	0.01	150	10
VK104MK151(1)011P050	6	9	5	0.6	5.5	11	14	18	35	0.8	0.01	150	100
VK105MK151(1)011P050	6	9	5	0.6	5.5	11	14	18	35	0.8	0.01	150	1000
VK103MK151(1)014P050	6	9	5	0.6	5.5	14	18	22	38	0.9	0.01	150	10
VK104MK151(1)014P050	6	9	5	0.6	5.5	14	18	22	38	0.9	0.01	150	100
VK105MK151(1)014P050	6	9	5	0.6	5.5	14	18	22	38	0.9	0.01	150	1000
VK103MK151(1)017P050	6	9	5	0.6	5.5	17	22	27	49	1.1	0.01	150	10
VK104MK151(1)017P050	6	9	5	0.6	5.5	17	22	27	49	1.1	0.01	150	100
VK105MK151(1)017P050	6	9	5	0.6	5.5	17	22	27	49	1.1	0.01	150	1000
VK103MK151(1)020P050	6	9	5	0.6	5.5	20	26	33	54	1.3	0.01	150	10
VK104MK151(1)020P050	6	9	5	0.6	5.5	20	26	33	54	1.3	0.01	150	100
VK105MK151(1)020P050	6	9	5	0.6	5.5	20	26	33	54	1.3	0.01	150	1000
VK103MK151(1)025P050	6	9	5	0.6	5.5	25	31	39	65	1.7	0.01	150	10
VK104MK151(1)025P050	6	9	5	0.6	5.5	25	31	39	65	1.7	0.01	150	100
VK105MK151(1)025P050	6	9	5	0.6	5.5	25	31	39	65	1.7	0.01	150	1000
VK103MK151(1)030P050	6	9	5	0.6	5.5	30	38	47	77	2.0	0.01	150	10
VK104MK151(1)030P050	6	9	5	0.6	5.5	30	38	47	77	2.0	0.01	150	100
VK105MK151(1)030P050	6	9	5	0.6	5.5	30	38	47	77	2.0	0.01	150	1000
VK103MK151(1)035P050	6	9	5	0.6	5.5	35	45	56	90	2.2	0.01	150	10
VK104MK151(1)035P050	6	9	5	0.6	5.5	35	45	56	90	2.2	0.01	150	100
VK105MK151(1)035P050	6	9	5	0.6	5.5	35	45	56	90	2.2	0.01	150	1000
VK103MK151(1)040P050	6	9	5	0.6	5.5	40	56	68	110	2.3	0.01	150	10
VK104MK151(1)040P050	6	9	5	0.6	5.5	40	56	68	110	2.3	0.01	150	100
VK105MK151(1)040P050	6	9	5	0.6	5.5	40	56	68	110	2.3	0.01	150	1000
VK103MK151(1)050P050	6	9	5	0.6	5.5	50	65	82	135	2.3	0.01	150	10
VK104MK151(1)050P050	6	9	5	0.6	5.5	50	65	82	135	2.3	0.01	150	100
VK105MK151(1)050P050	6	9	5	0.6	5.5	50	65	82	135	2.3	0.01	150	1000
VK103MK151(1)060P050	6	9	5	0.6	5.5	60	85	100	165	2.3	0.01	150	10
VK104MK151(1)060P050	6	9	5	0.6	5.5	60	85	100	165	2.3	0.01	150	100
VK105MK151(1)060P050	6	9	5	0.6	5.5	60	85	100	165	2.3	0.01	150	1000
VK103MK151(1)095P050	6	9	5	0.6	5.5	95	125	150	250	2.5	0.01	150	10
VK104MK151(1)095P050	6	9	5	0.6	5.5	95	125	150	250	2.5	0.01	150	100
VK105MK151(1)095P050	6	9	5	0.6	5.5	95	125	150	250	2.5	0.01	150	1000
	mm	mm	mm	mm	mm	V	V	V	V	J	W	A	nF
Kemet Part Number	D _{max}	A _{max}	R	d	t _{max}	V _{rms}	VDC	V _n 1 mA	V _c at 1A	W _{max} 10/1000 μs	P _{max}	I _{max} 8/20 μs	C at 1 kHz

(1) Insert packaging/lead Style code. See Ordering Options Table for available options.

Soldering

Very often before soldering through-hole components, their leads get bent. It is important not to damage the component during lead bending. Typical damage incurred during bending is cracks in epoxy parts, which can lead to increased humidity sensitivity of a component and consequentially to a shorter life time.

In order to avoid epoxy parts damage it is necessary to:

- fix the most sensitive point (epoxy parts) of a component body
- bend the wire at least 2 mm below the end of epoxy parts

Other potential damage to a component which can lead to component failure or a shorter life time is thermal shock during manual soldering with a soldering iron. This can occur in the case when a soldering iron is placed too close to one point of the component body and most often it happens if the solder joint is too close to the varistor body.



Resistance to Soldering Heat – In the case of automatic wave soldering, it is important to provide sufficient resistance to soldering heat. In order to prevent any potential problems the standard for testing the resistance to soldering heat of through-hole components is 300°C, 10s.

Pb-free Wave Soldering Profile Recommendations – Recommended soldering profiles for all above components are in accordance with JEDEC standard curves (J-STD-020D) and therefore compatible with the new Pb-free process.

Soldering (cont'd)

Lead-free Wave Soldering Profile



Parameters	Symbol	Specification
Preheating temperature gradient		4°C/s maximum
Preheating time	t_1	2 to 5 minutes
Minimum preheating temperature	T_1	130°C
Maximum preheating temperature	T_2	180°C
Melting temperature/point	T_{melt}	217°C
Time in wave soldering phase (w1+w2)	t_{w1+w2}	10 seconds
Maximum wave temperature (w1+w2)	T_3	265°C +0/-5°C
Cooling temperature gradient		6°C/seconds maximum
Temperature jump from T_2 to T_3 (w1)	$T_3(w1) - T_3(w1) - T_2$	120°C maximum
Time from 25°C to T_3 (wave temperature)		8 minutes maximum

Packaging

B	R
1,500	1,500

Construction



Capacitor Marking



Taping & Reel Specifications

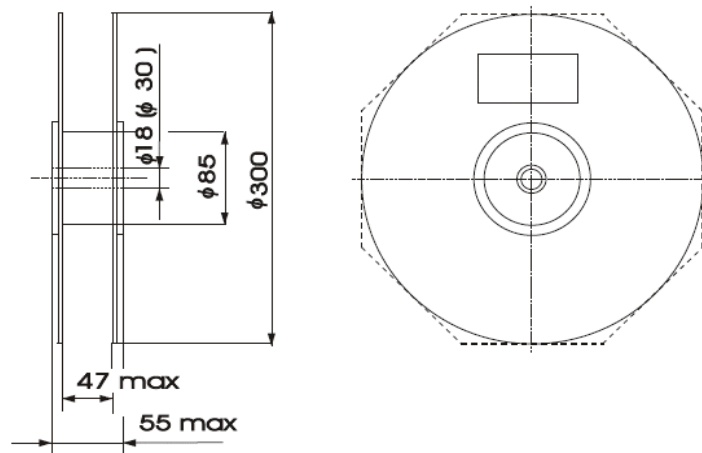
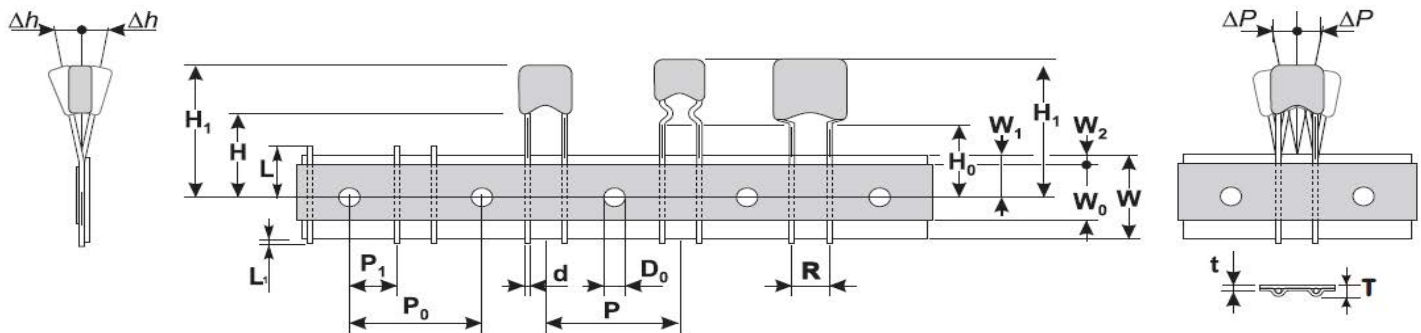

Symbol	Parameter	Dimension (mm)
W	Carrier tape with	18+1.0/-0.5
W ₀	Hold down tape width	5 minimum
W ₁	Sprocket hole position	9+0.75/-0.5
W ₂	Distance between the upper edges of the carrier tape and hold-down tape	3 maximum
T	Total tape thickness	1.5 maximum
t	Tape thickness	0.9 maximum
P	Pitch of component	12.7±1.0
P ₀	Feed hole pitch	12.7±0.3
P ₁	Feed hole center to pitch	3.85±0.7
R	Lead Spacing	5+0.5/-0.2
ΔP	Component alignment	±1.3 maximum
Δh	Component alignment	±2 maximum
d	Wire diameter	0.6 maximum
D ₀	Feed hole diameter	4±0.2
H	Height from tape center to comp. base	18+2.0/-0.0
H ₀	Seating plane height	16±0.5
H ₁	Component height	32.2 maximum
L	Protrusion - cut out	11 maximum
L ₁	Protrusion - cut off	0.5 maximum

Terms and Definitions

Term	Symbol	Definition
Rated AC Voltage	V_{rms}	Maximum continuous sinusoidal AC voltage (<5% total harmonic distortion) which may be applied to the component under continuous operation conditions at 25°C
Rated DC Voltage	V_{dc}	Maximum continuous DC voltage (<5% ripple) which may be applied to the component under continuous operating conditions at 25°C
Supply Voltage	V	The voltage by which the system is designated and to which certain operating characteristics of the system are referred; $V_{rms} = 1,1 \times V$
Leakage Current	I_{dc}	The current passing through the varistor at Vdc and at 25°C or at any other specified temperature
Varistor Voltage	V_n	Voltage across the varistor measured at a given reference current I_n
Reference Current	I_n	Reference current = 1 mA DC
Clamping Voltage Protection Level	V_c	The peak voltage developed across the varistor under standard atmospheric conditions, when passing an 8/20 μ s class current pulse
Class Current	I_c	A peak value of current which is 1/10 of the maximum peak current for 100 pulses at two per minute for the 8/20 μ s pulse
Voltage Clamping Ratio	V_c/V_{app}	A figure of merit measure of the varistor clamping effectiveness as defined by the symbols V_c/V_{app} , where ($V_{app} = V_{rms}$ or V_{dc})
Jump Start Transient	V_{jump}	The jump start transient resulting from the temporary application of an overvoltage in excess of the rated battery voltage. The circuit power supply may be subjected to a temporary overvoltage condition due to the voltage regulation failing or it may be deliberately generated when it becomes necessary to boost start the car
Rated Single Pulse Transient Energy	W_{max}	Energy which may be dissipated for a single 10/1000 μ s pulse of a maximum rated current, with rated AC voltage or rated DC voltage also applied, without causing device failure
Load Dump Transient	WLD	Load Dump is a transient which occurs in an automotive environment. It is an exponentially decaying positive voltage which occurs in the event of a battery disconnect while the alternator is still generating charging current with other loads remaining on the alternator circuit at the time of battery disconnect
Rated Peak Single Pulse Transient Current	I_{max}	Maximum peak current which may be applied for a single 8/20 μ s pulse, with, rated line voltage also applies, without causing device failure
Rated Transient Average Power Dissipation	P	Maximum average power which may be dissipated due to a group of pulses occurring within a specified isolated time period, without causing device failure at 25°C
Capacitance	C	Capacitance between two terminals of the varistor measured at at 1 kHz
Response Time	tr	The time lag between application of a surge and varistor's "turn-on" conduction action
Varistor Voltage Temperature Coefficient	TC	$(V_n \text{ at } 85^\circ\text{C} - V_n \text{ at } 25^\circ\text{C}) / (V_n \text{ at } 25^\circ\text{C}) \times 60^\circ\text{C} \times 100$
Insulation Resistance	IR	Minimum resistance between shorted terminals and varistor surface
Isolation Voltage		The maximum peak voltage which may be applied under continuous operating conditions between the varistor terminations and any conducting mounting surface
Operating Temperature		The range of ambient temperature for which the varistor is designed to operate continuously as defined by the temperature limits of its climatic category
Climatic Category	LCT/UCT/DHD	UCT = Upper Category Temperature – the maximum ambient temperature for which a varistor has been designed to operate continuously, LCT = Lower Category Temperature – the minimum ambient temperature at which a varistor has been designed to operate continuously DHD = Dump Heat Test Duration
Storage Temperature		Storage temperature range without voltage applied