

A new generation, long distance ranging Time-of-Flight sensor based on ST's FlightSense technology

Datasheet - production data

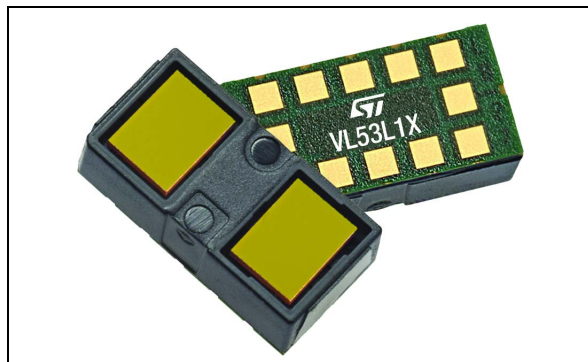

Features

- Fully integrated miniature module
 - Size: 4.9x2.5x1.56 mm
 - Emitter: 940 nm invisible laser (Class1)
 - SPAD (single photon avalanche diode) receiving array with integrated lens
 - Low-power microcontroller running advanced digital firmware
- Pin-to-pin compatible with the VL53L0X FlightSense ranging sensor
- Fast and accurate long distance ranging
 - Up to 400 cm distance measurement
 - Up to 50 Hz ranging frequency
- Typical full field-of-view (FoV): 27°
- Programmable region-of-interest (ROI) size on the receiving array, allowing the sensor FoV to be reduced
- Programmable ROI position on the receiving array, providing multizone operation control from the host
- Easy integration
 - Single reflowable component
 - Can be hidden behind many cover window materials
 - Software driver and code examples for turnkey ranging
 - Single power supply (2v8)
 - I²C interface (up to 400 kHz)
 - Shutdown and interrupt pins

Applications

- User detection (autonomous low-power mode) to power on/off and lock/unlock devices like personal computers/laptops and the IoT
- Service robots and vacuum cleaners (long distance and fast obstacle detection)
- Drones (landing assistance, hovering, ceiling detection)
- Smart shelves and vending machines (goods inventory monitoring)
- Sanitary (robust user detection whatever the target reflectance)
- Smart building and smart lighting (people detection, gesture control)
- 1 D gesture recognition
- Laser assisted autofocus which enhances the camera autofocus system speed and robustness, especially in difficult scenes (low light and low contrast) and video focus tracking assistance

Description

The VL53L1X is a state-of-the-art, Time-of-Flight (ToF), laser-ranging sensor, enhancing the ST FlightSense product family. It is the fastest miniature ToF sensor on the market with accurate ranging up to 4 m and fast ranging frequency up to 50 Hz

Housed in a miniature and reflowable package, it integrates a SPAD receiving array, a 940 nm invisible Class1 laser emitter, physical infrared filters, and optics to achieve the best ranging performance in various ambient lighting conditions with a range of cover window options.

Unlike conventional IR sensors, the VL53L1X uses ST's latest generation ToF technology which allows absolute distance measurement whatever the target color and reflectance.

It is also possible to program the size of the ROI on the receiving array, allowing the sensor FoV to be reduced.

Contents

- 1 **Product overview** 4**
 - 1.1 Technical specification 4
 - 1.2 System block diagram 4
 - 1.3 Device pinout 5
 - 1.4 Application schematic 6

- 2 **Functional description** 7**
 - 2.1 System functional description 7
 - 2.2 System state machine description 8
 - 2.3 Customer manufacturing calibration flow 9
 - 2.4 Ranging description 9
 - 2.5 Key parameters 10
 - 2.5.1 Distance mode 10
 - 2.5.2 Timing budget (TB) 11
 - 2.6 Power sequence 12
 - 2.6.1 Power up and boot sequence 12
 - 2.7 Ranging sequences 13
 - 2.8 Sensing array optical center 14

- 3 **Ranging performances** 15**
 - 3.1 Test conditions 15
 - 3.2 Accuracy, repeatability, and ranging error definitions 16
 - 3.2.1 Accuracy definition 16
 - 3.2.2 Repeatability definition 16
 - 3.2.3 Ranging error definition 16
 - 3.3 Minimum ranging distance 16
 - 3.4 Performances in dark conditions 16
 - 3.5 Performances in ambient light conditions 17
 - 3.5.1 Long distance mode 17
 - 3.5.2 Short distance mode 17
 - 3.6 Performances in partial ROI in dark conditions 18

4	Control interface	19
4.1	I ² C interface - timing characteristics	21
4.2	I ² C interface - reference registers	22
5	Electrical characteristics	23
5.1	Absolute maximum ratings	23
5.2	Recommended operating conditions	23
5.3	ESD	23
5.4	Current consumption	24
5.5	Digital I/O electrical characteristics	24
6	Outline drawing	25
7	Laser safety considerations	28
8	Packaging and labeling	29
8.1	Product marking	29
8.2	Inner box labeling	29
8.3	Packing	29
8.4	Tape outline drawing	30
8.5	Pb-free solder reflow process	31
8.6	Handling and storage precautions	32
8.6.1	Shock precaution	32
8.6.2	Part handling	32
8.6.3	Compression force	32
8.6.4	Moisture sensitivity level	32
8.7	Storage temperature conditions	32
9	Ordering information	33
10	Acronyms and abbreviations	33
11	ECOPACK[®]	33
12	Revision history	34

1 Product overview

1.1 Technical specification

Table 1. Technical specification

Feature	Detail
Package	Optical LGA12
Size	4.9 x 2.5 x 1.56 mm
Operating voltage	2.6 to 3.5 V
Operating temperature:	-20 to 85°C
Receiver Field Of View (diagonal FOV)	Programmable from 15 to 27 degrees
Infrared emitter	940 nm
I ² C	Up to 400 kHz (Fast mode) serial bus Programmable address. Default is 0x52.

1.2 System block diagram

Figure 1. VL53L1X block diagram

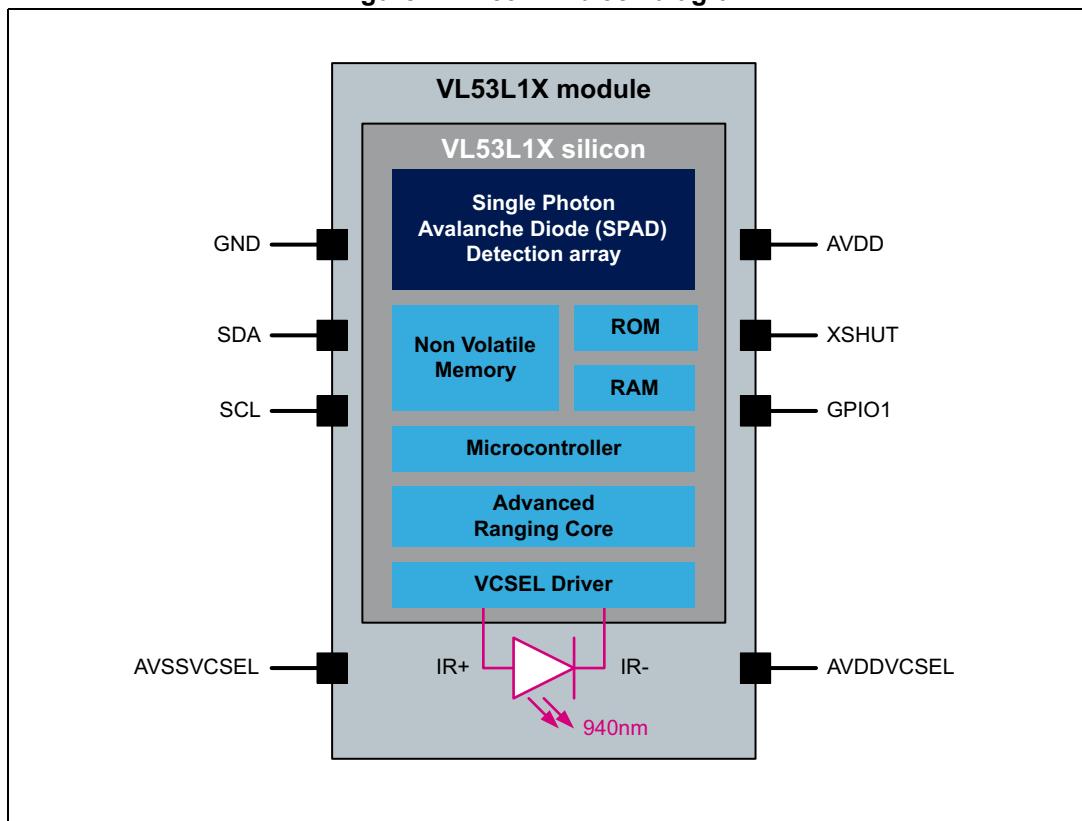

1.3 Device pinout

Figure 2 shows the pinout of the VL53L1X (see also Figure 18).

Figure 2. VL53L1X pinout (bottom view)

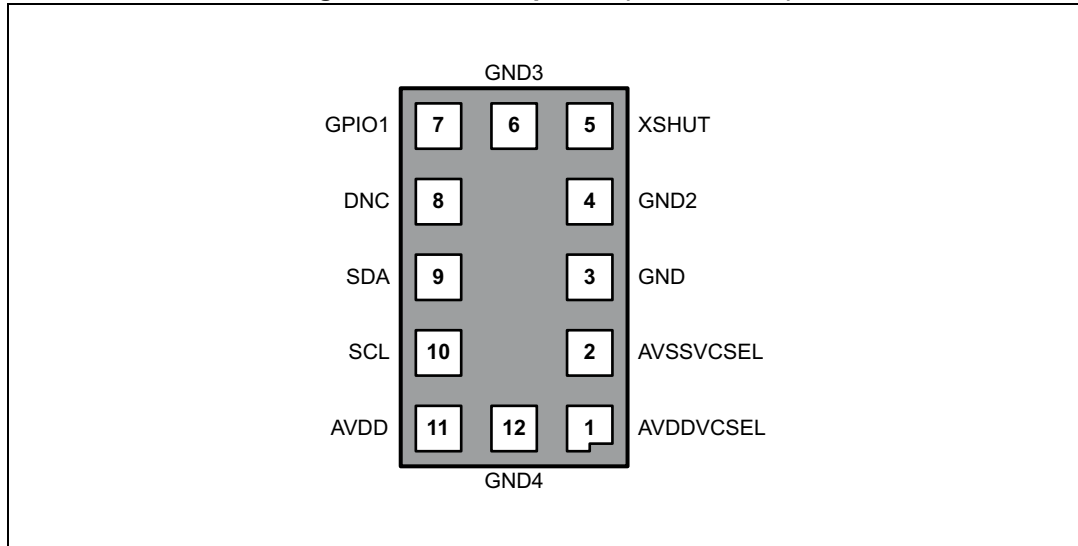

Table 2. VL53L1X pin description

Pin number	Signal name	Signal type	Signal description
1	AVDDVCSEL	Supply	VCSEL supply, to be connected to main supply
2	AVSSVCSEL	Ground	VCSEL ground, to be connected to main ground
3	GND	Ground	To be connected to main ground
4	GND2	Ground	To be connected to main ground
5	XSHUT	Digital input	Xshutdown pin, active low
6	GND3	Ground	To be connected to main ground
7	GPIO1	Digital output	Interrupt output. Open drain output
8	DNC	Digital input	Do not connect, must be left floating
9	SDA	Digital input/output	I ² C serial data
10	SCL	Digital input	I ² C serial clock input
11	AVDD	Supply	Supply, to be connected to main supply
12	GND4	Ground	To be connected to main ground

Note: AVSSVCSEL and GND are ground pins and can be connected together in the application schematics.

GND2, GND3, and GND4 are standard pins that we force to the ground domain in the application schematics to avoid possible instabilities if set to other states.

1.4 Application schematic

Figure 3 shows the application schematic of the VL53L1X.

Figure 3. VL53L1X schematic

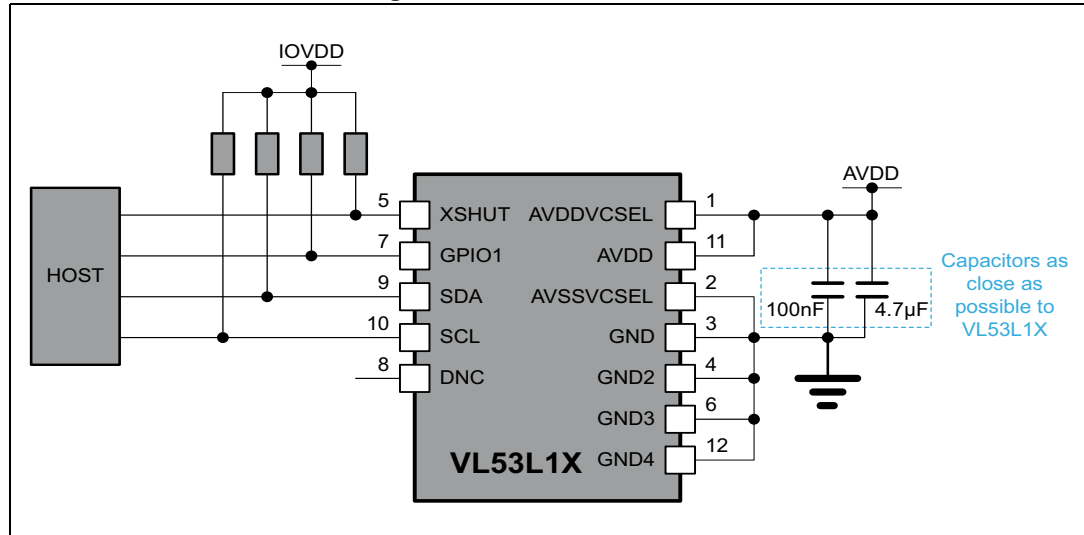

Note: Capacitors on external supply AVDD should be placed as close as possible to the AVDDVCSEL and AVSSVCSEL module pins.

Note: External pull up resistor values can be found in I²C-bus specification. Pull ups are typically fitted only once per bus, near the host. For suggested values see Table 3.

Note: XSHUT pin must always be driven to avoid leakage current. A pull up is needed if the host state is not known.

XSHUT is needed to use HW standby mode (no I²C communication).

Note: XSHUT and GPIO1 pull up recommended values are 10 kOhms

Note: GPIO1 to be left unconnected if not used

Table 3 show recommended values for the pull up and series resistors for an AVDD of 1.8 V to 2.8 V in I²C Fast mode (up to 400 kHz).

Table 3. Suggested pull up and series resistors for I²C Fast mode

I ² C load capacitance (C _L) ⁽¹⁾	Pull up resistor (Ohms)
C _L ≤ 90 pF	3.6 k
90 pF < C _L ≤ 140 pF	2.4 k
140 pF < C _L ≤ 270 pF	1.2 k
270 pF < C _L ≤ 400 pF	0.8 k

1. For each bus line, C_L is measured in the application PCB by the customer.

2 Functional description

2.1 System functional description

Figure 4 shows the system level functional description. The host customer application controls the VL53L1X device using an API (application programming interface). The API implementation is delivered to the customer as a driver (Bare C code).

The driver shares with the customer application a set of high-level functions that allow control of the VL53L1X like initialization, ranging start/stop, and setting the system accuracy.

The driver enables fast development of end user applications without the complication of direct multiple register access. The driver is structured in a way that it can be compiled on any kind of platform through a good hardware abstraction layer.

A detailed description of the driver is available in the VL53L1X API user manual (UM2356).

Figure 4. VL53L1X system functional description

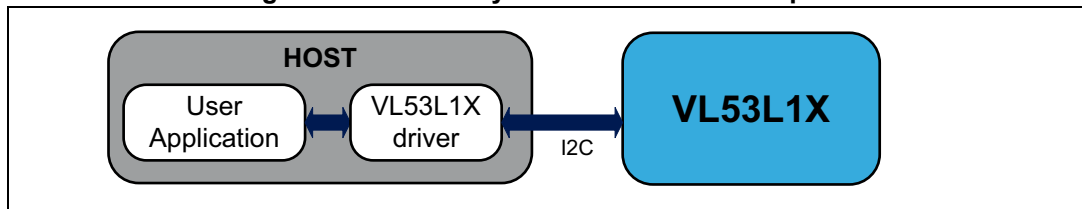

2.2 System state machine description

Figure 5 shows the system state machine.

Figure 5. System state machine

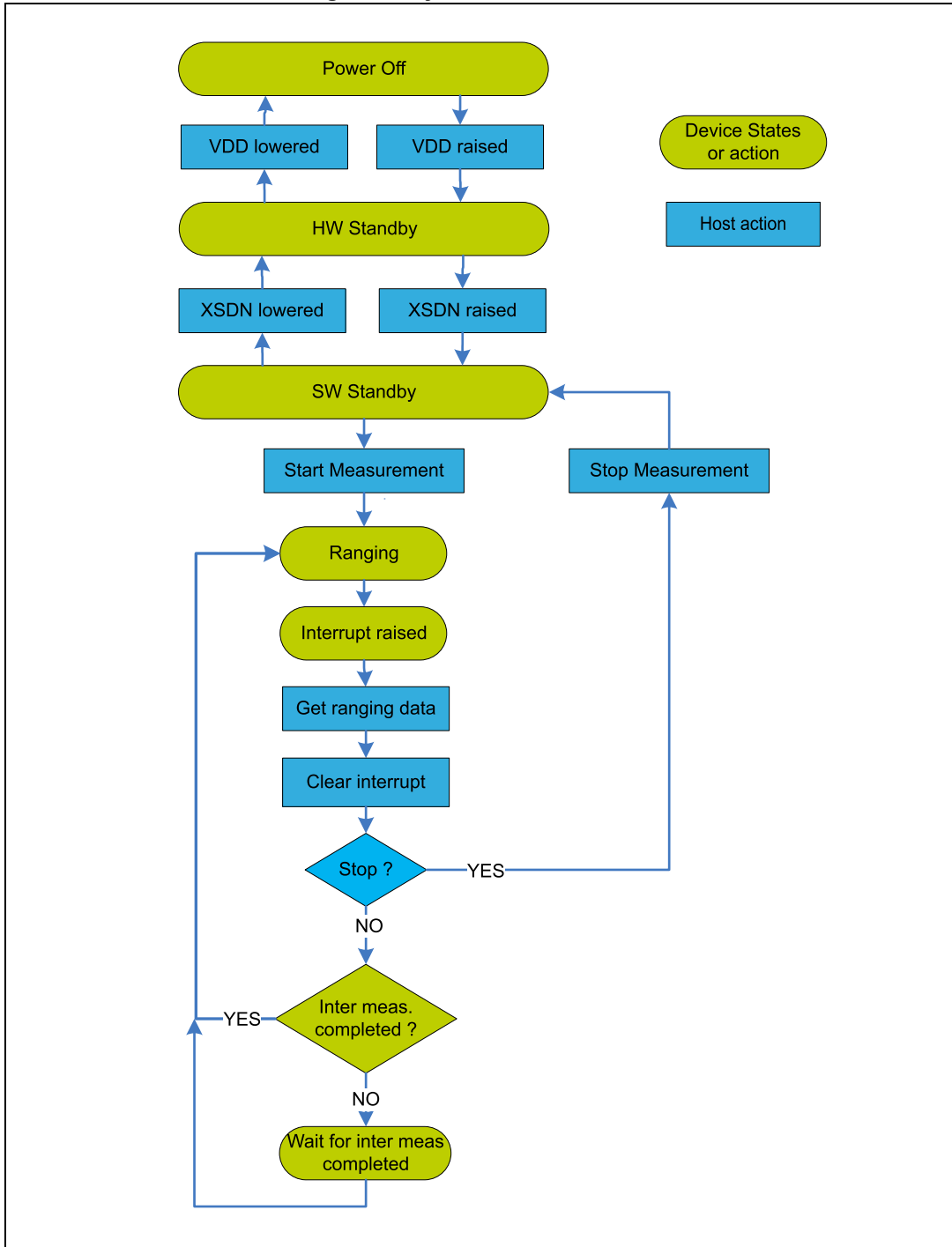

2.3 Customer manufacturing calibration flow

The VL53L1X driver includes calibration functions. To benefit from device full performances, it is recommended they be run once at the customer production line.

Device calibration allows part-to-part parameter variations and cover glass presence that may affect device performances to be compensated.

Calibration data stored in the host have to be loaded into the VL53L1X at each startup using a dedicated driver function.

Three calibration steps are needed: RefSPAD, offset and crosstalk.

RefSPAD and crosstalk calibrations have to be performed whenever the customer adds a protective cover glass on top of the VL53L1X module.

Offset calibration has to be performed in all situations. It allows reflow and cover glass effects to be compensated.

The detailed procedure is provided in the VL53L1X API user manual (UM2356).

2.4 Ranging description

The VL53L1X software driver proposes turnkey solution to allow fast implementation and easy ranging in all customer applications:

Autonomous ranging mode is the default configuration that offers the optimized VL53L1X functionalities.

- Ranging is continuous, with a programmable delay between two ranging operations (called an inter-measurement period). Ranging duration (timing budget) is also programmable.
- The user can set distance thresholds (below, above, inside, or outside the user-defined thresholds). An interrupt is raised only when threshold conditions are met.
- ROI size and position are programmable: the user may chose a custom FoV from 4x4 SPADs (minimum size) up to 16x16 SPADs (full FoV).
- A clear interrupt is mandatory to allow the next ranging data to be updated.

If the ranging distance cannot be measured (in the case of no target or a weak signal), a corresponding range status is generated and can be read by the host.

The VL53L1X software driver provides turnkey functions to read output results after the measurement. The main values reported are:

- Ranging distance in mm
- Return signal rate
- Ambient signal rate
- Range status

Range status and output measurement definitions are provided in the VL53L1X API user manual (UM2356).

2.5 Key parameters

2.5.1 Distance mode

The VL53L1X has three distance modes (DM): short, medium, and long.

Long distance mode allows the longest possible ranging distance of 4 m to be reached. However, this maximum ranging distance is impacted by ambient light.

Short distance mode is more immune to ambient light, but its maximum ranging distance is typically limited to 1.3 m.

Table 4. Maximum distance vs. Distance mode under ambient light

Distance mode	Max. distance in dark (cm)	Max. distance under strong ambient light (cm)
Short	136	135
Medium	290	76
Long	360	73

Test conditions: timing budget = 100 ms, white target 88%, dark = no IR ambient, ambient light = 200 kcps/SPAD.

2.5.2 Timing budget (TB)

The VL53L1X timing budget can be set from 20 ms up to 1000 ms.

- 20 ms is the minimum timing budget and can be used only in Short distance mode.
- 33 ms is the minimum timing budget which can work for all distance modes.
- 140 ms is the timing budget which allows the maximum distance of 4 m (in the dark on a white chart) to be reached under Long distance mode

Increasing the timing budget increases the maximum distance the device can range and improves the repeatability error. However, average power consumption augments accordingly.

Figure 6. Maximum distance and repeatability error vs. timing budget

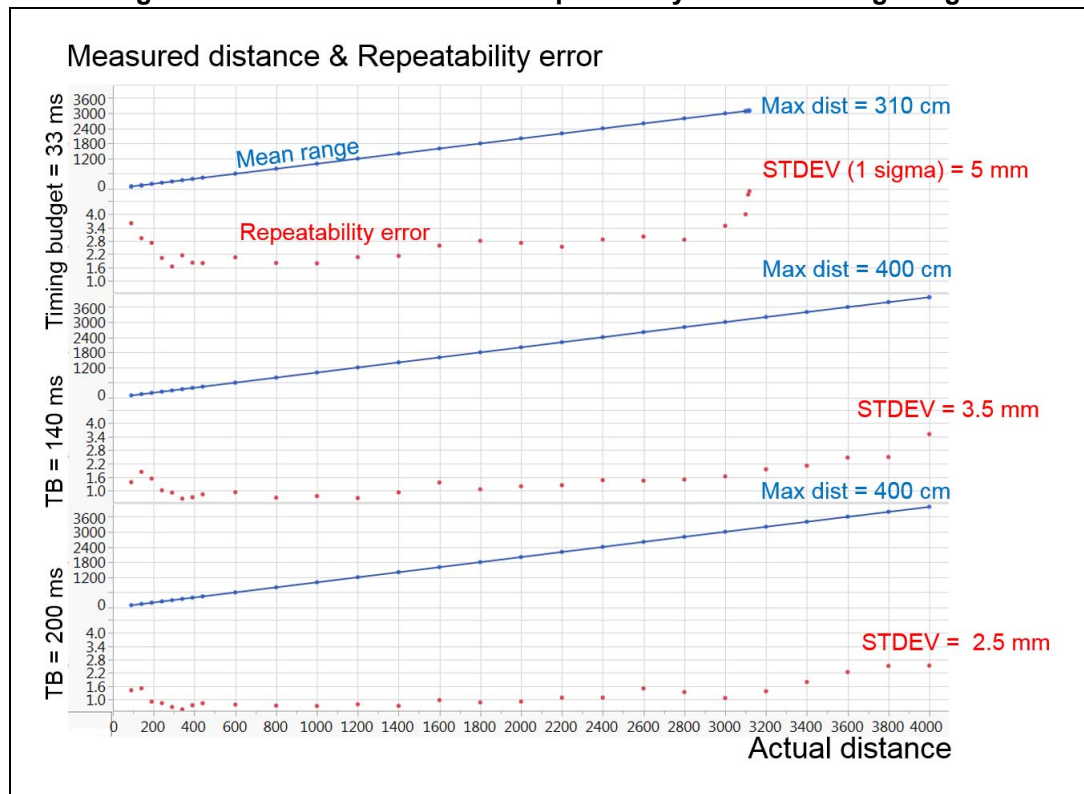

Test conditions: timing budget = 33 ms, 140 ms, 200 ms, grey target 54%, ambient light = dark.

2.6 Power sequence

2.6.1 Power up and boot sequence

There are two options available for device power up/boot.

Option 1: the XSHUT pin is connected and controlled from the host.

This option optimizes power consumption as the VL53L1X can be completely powered off when not used, and then woken up through a host GPIO (using the XSHUT pin).

Hardware standby mode is defined as the period when the power supply is present and XSHUT is low.

Figure 7. Power up and boot sequence

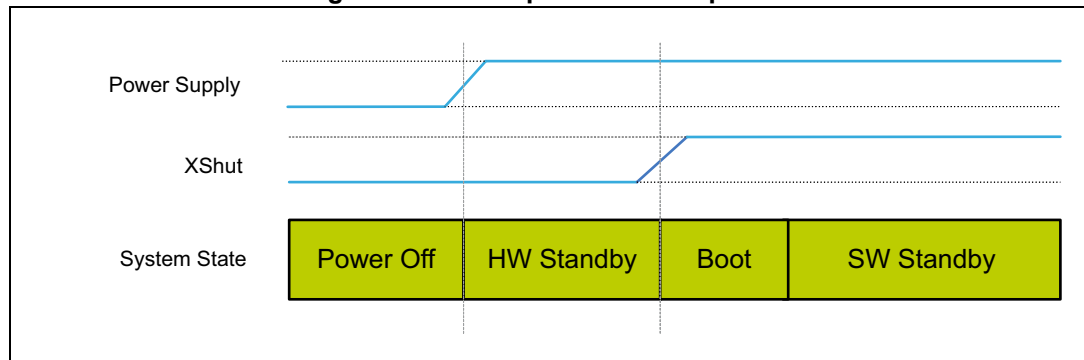

Note: Boot duration is 1.2ms max.

Option 2: the XSHUT pin is not controlled by the host, it is tied to the power supply value through the pull up resistor.

When the XSHUT pin is not controlled, the power up sequence is presented in [Figure 8](#). In this case, the device goes automatically to software standby after boot, without entering hardware standby.

Figure 8. Power up and boot sequence with XSHUT not controlled

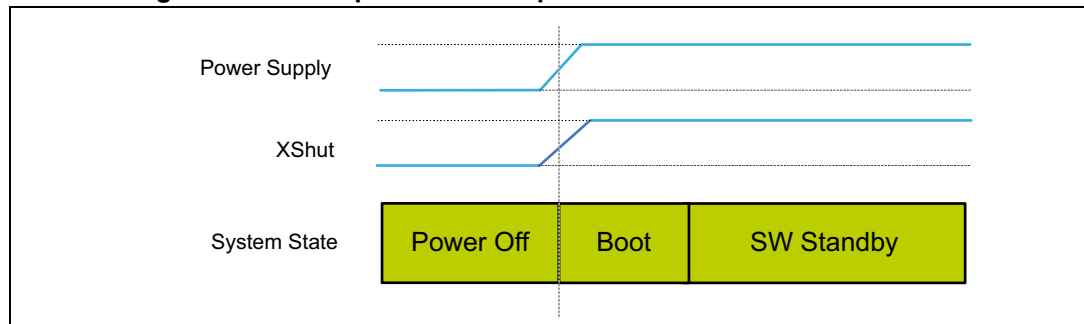

Note: Boot duration is 1.2 ms max.

Note: In all cases, XSHUT has to be raised only when the power supply is tied on.

2.7 Ranging sequences

The following figure shows the combination of the driver commands and the system states.

Figure 9. Autonomous sequence

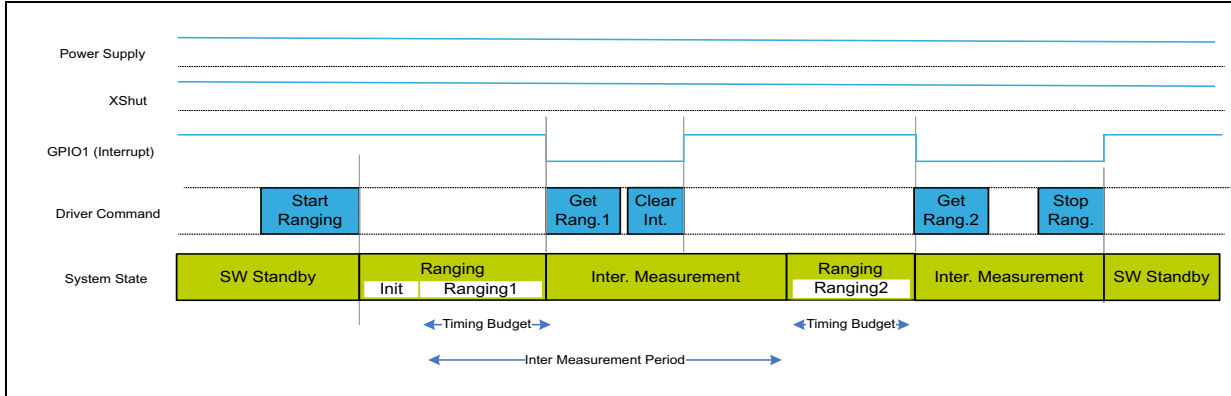

Note: Timing budget and inter measurement timings are the parameters set by the user, using a dedicated driver function.

2.8 Sensing array optical center

VL53L1X module includes a lens that focus the photons on the 16x16 SPADs sensing array. The sensing array optical center specification takes into account the part-to-part variation in production.

The optical center is defined by coordinates (Xo and Yo).

The optical center is measured for each part during a factory test at STMicroelectronics. The coordinates are stored in the VL53L1X non-volatile memory and are readable by the customer through the software driver in the application. This helps optimize design alignment with the camera and ranging performances in the application.

The green array in [Figure 10: Optical center specification](#) gives the possible location of the optical center.

Table 5. Optical center specification

Parameter	Min.	Typ.	Max.	Unit
Xo offset	-2	0	2	SPAD
Yo offset	-2	0	2	

Figure 10. Optical center specification

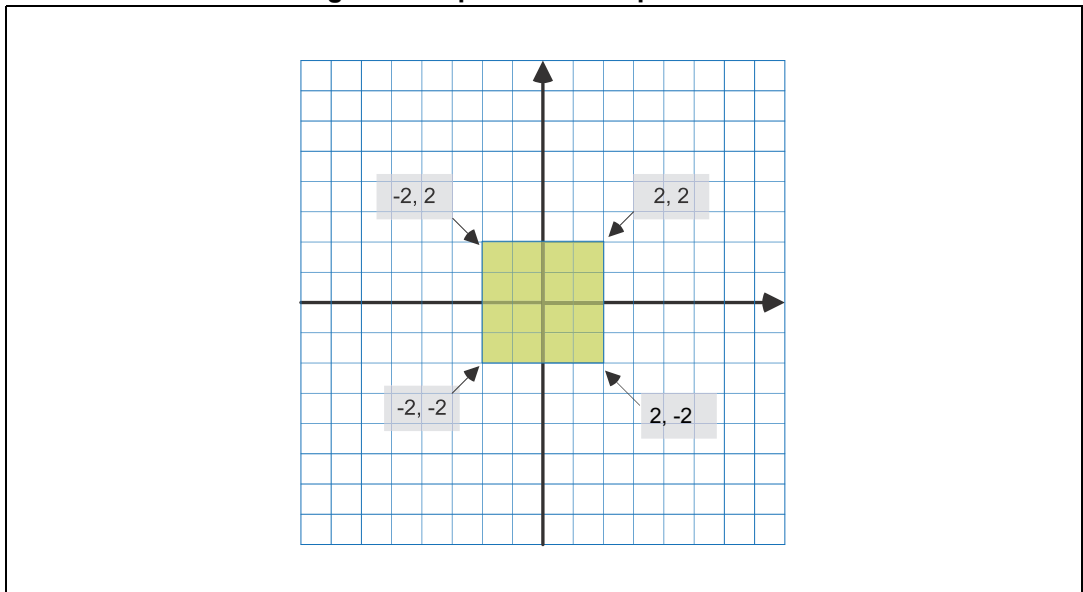

For more details please refer to VL53L1X API user manual (UM2356)

3 Ranging performances

3.1 Test conditions

In all measurement tables of this specification, it is considered that:

1. The full FoV (typically 27°) is covered or a partial FoV is covered after a specific ROI is programmed by the user (array size from 4x4 SPADs to 16x16 SPADs).
2. Charts used as targets are: grey 17% reflectance (N4.74 Munsell), grey 54% reflectance (N8.25 Munsell), and white 88% reflectance (N9.5 Munsell).
3. Nominal voltage (2.8 V) and temperature (23°C).
4. Detection rate is considered as 100%.
5. Unless mentioned, the device is setup and controlled through the driver using the following settings:
 - a) Distance mode is long
 - b) Timing budget is 100 ms
 - c) No cover glass is present
 - d) Target covers the full FoV
6. Ambient light is defined as follows:
 - a) Dark = no IR light in the band 940 nm \pm 30 nm
 - b) 50 kcps/SPAD = lighting on a sunny day from behind a window^(a)
 - c) 200 kcps/SPAD = lighting on a sunny day from behind a window, with direct illumination on the sensor
 - d) For reference, usual office lighting is around 5 kcps/SPAD

a. kcps is kilo counts per second. kcps/SPAD is the return ambient rate measured by the VL53L1X.

3.2 Accuracy, repeatability, and ranging error definitions

3.2.1 Accuracy definition

Accuracy = mean distance – actual distance

- Mean distance is the average of 32 measured distances
- Actual distance is the actual target distance

Accuracy can be affected by an offset error, a temperature drift, and a voltage drift.

3.2.2 Repeatability definition

Repeatability is the standard deviation of the mean ranging value of 32 measurements. It can be improved by increasing the timing budget. A typical repeatability value for VL53L1X is from $\pm 1\%$ to $\pm 0.15\%$ depending on the timing budget and the ambient light.

3.2.3 Ranging error definition

Ranging error = accuracy + repeatability error.

This ranging error value is our metrics in the following performances tables.

3.3 Minimum ranging distance

The minimum ranging distance is 4 cm. Under this minimum distance, the sensor will detect a target, but the measurement will not be accurate.

3.4 Performances in dark conditions

Table 6. Performances in dark conditions

Parameter	Target reflectance	Min. value	Typ. value
Max distance (cm)	White 88%	260	360 (400 with TB = 140 ms)
	Grey 54%	220	340
	Grey 17%	80	170
Ranging error (mm)		± 20	

Test conditions (including those described in [Section 3.1: Test conditions](#)) are:

- Ambient light = dark
- Timing budget = 100 ms unless mentioned
- Long distance mode

3.5 Performances in ambient light conditions

3.5.1 Long distance mode

Table 7. Typical performances in ambient light with long distance mode

Parameter	Target reflectance	Dark	50 kcps/SPAD	200 kcps/SPAD
Max. distance (cm)	White 88%	360	166	73
	Grey 54%	340	154	69
	Grey 17%	170	114	68
Ranging error (mm)		± 20	± 25	± 25

Test conditions (including those described in [Section 3.1: Test conditions](#)) are:

- Ambient light = dark, 50 kcps/SPAD, 200 kcps/SPAD
- Distance mode = long

3.5.2 Short distance mode

Table 8. Typical performances in ambient light conditions with short distance mode

Parameter	Target reflectance	Dark	200 kcps/SPAD
Max. distance (cm)	White 88%	130	130
	Grey 54%	130	130
	Grey 17%	130	120
Ranging error (mm)		± 20	± 25

Test conditions (including those described in [Section 3.1: Test conditions](#)) are:

- Ambient light = dark, 200 kcps/SPAD
- Distance mode = short

3.6 Performances in partial ROI in dark conditions

Table 9. Typical performances in partial ROI in dark conditions

Parameter	Target reflectance	16x16	8x8	4x4
Max. distance (cm)	White 88%	360	308	170
	Grey 54%	340	254	143
	Grey 17%	170	119	45
Diagonal FoV (degrees)		27	20	15
Ranging error (mm)		± 20	± 20	± 20

Test conditions (including those described in [Section 3.1: Test conditions](#)) are:

- Ambient light = dark
- Target covers partial FoV
- ROI centered on optical center
- Long distance mode

4 Control interface

This section specifies the control interface. The I²C interface uses two signals: the serial data line (SDA) and serial clock line (SCL). Each device connected to the bus uses a unique address and a simple master/slave relationships exists.

Both SDA and SCL lines are connected to a positive supply voltage using pull up resistors located on the host. Lines are only actively driven low. A high condition occurs when the lines float and the pull up resistors pull them up. When no data are transmitted both lines are high.

Clock signal (SCL) generation is performed by the master device. The master device initiates data transfer. The I²C bus on the VL53L1X has a maximum speed of 400 kbits/s and uses a device address of 0x52.

Figure 11. Data transfer protocol

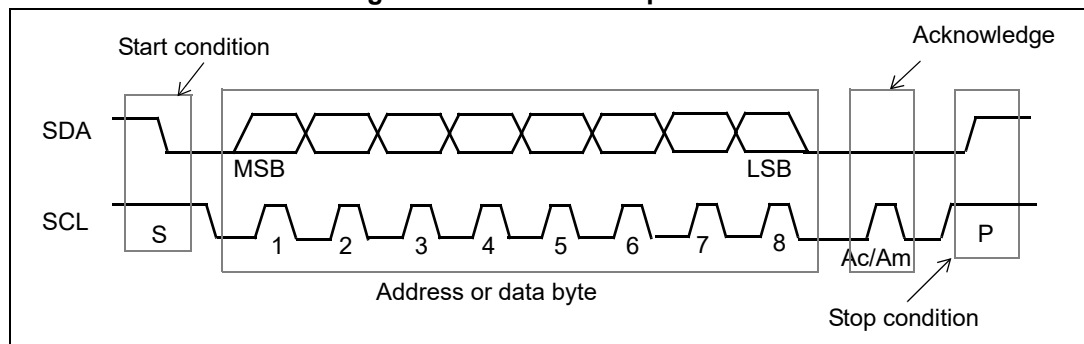

Information is packed in 8-bit packets (bytes) always followed by an acknowledge bit, Ac for VL53L1X acknowledge and Am for master acknowledge (host bus master). The internal data are produced by sampling SDA at a rising edge of SCL. The external data must be stable during the high period of SCL. The exceptions to this are start (S) or stop (P) conditions when SDA falls or rises respectively, while SCL is high.

A message contains a series of bytes preceded by a start condition and followed by either a stop or repeated start (another start condition but without a preceding stop condition) followed by another message. The first byte contains the device address (0x52) and also specifies the data direction. If the least significant bit is low (that is, 0x52) the message is a master-write-to-the-slave. If the LSB is set (that is, 0x53) then the message is a master-read-from-the-slave.

Figure 12. VL53L1X I²C device address: 0x52

MSBit							LSBit
0	1	0	1	0	0	1	R/W

All serial interface communications with the Time-of-Flight sensor must begin with a start condition. The VL53L1X module acknowledges the receipt of a valid address by driving the SDA wire low. The state of the read/write bit (LSB of the address byte) is stored and the next byte of data, sampled from SDA, can be interpreted. During a write sequence, the second byte received provides a 16-bit index which points to one of the internal 8-bit registers.

Figure 13. VL53L1X data format (write)

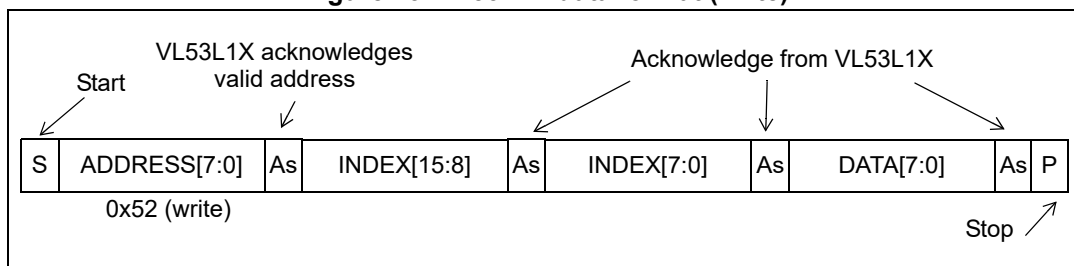

As data are received by the slave, they are written bit-by-bit to a serial/parallel register. After each data byte has been received by the slave, an acknowledge is generated, the data are then stored in the internal register addressed by the current index.

During a read message, the contents of the register addressed by the current index is read out in the byte following the device address byte. The contents of this register are parallel loaded into the serial/parallel register and clocked out of the device by the falling edge of SCL.

Figure 14. VL53L1X data format (read)

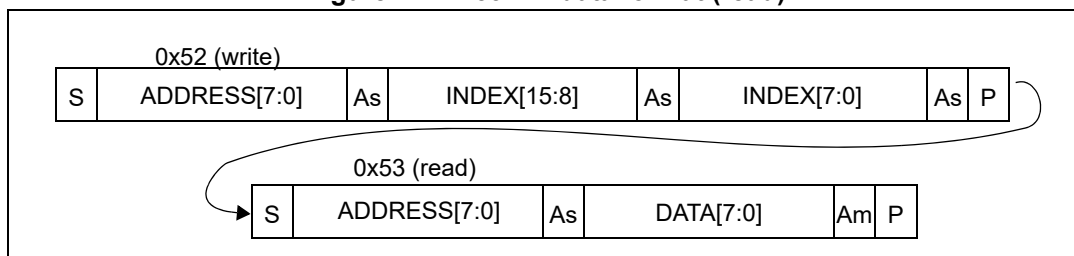

At the end of each byte, in both read and write message sequences, an acknowledge is issued by the receiving device (that is, the VL53L1X for a write and the host for a read).

A message can only be terminated by the bus master, either by issuing a stop condition or by a negative acknowledge (that is, **not** pulling the SDA line low) after reading a complete byte during a read operation.

The interface also supports auto-increment indexing. After the first data byte has been transferred, the index is automatically incremented by 1. The master can therefore send data bytes continuously to the slave until the slave fails to provide an acknowledge or the master terminates the write communication with a stop condition. If the auto-increment feature is used the master does **not** have to send address indexes to accompany the data bytes.

Figure 15. VL53L1X data format (sequential write)

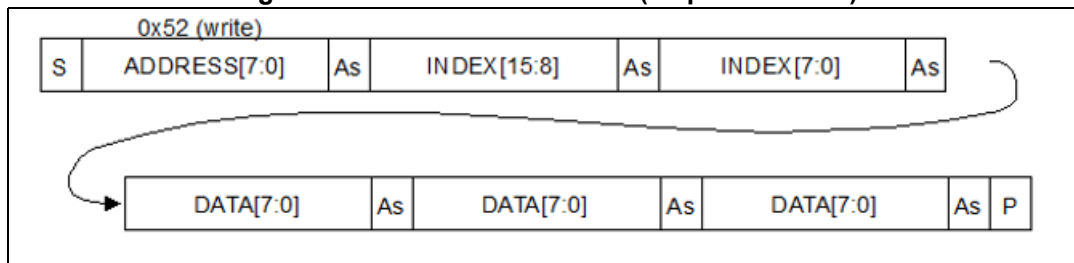
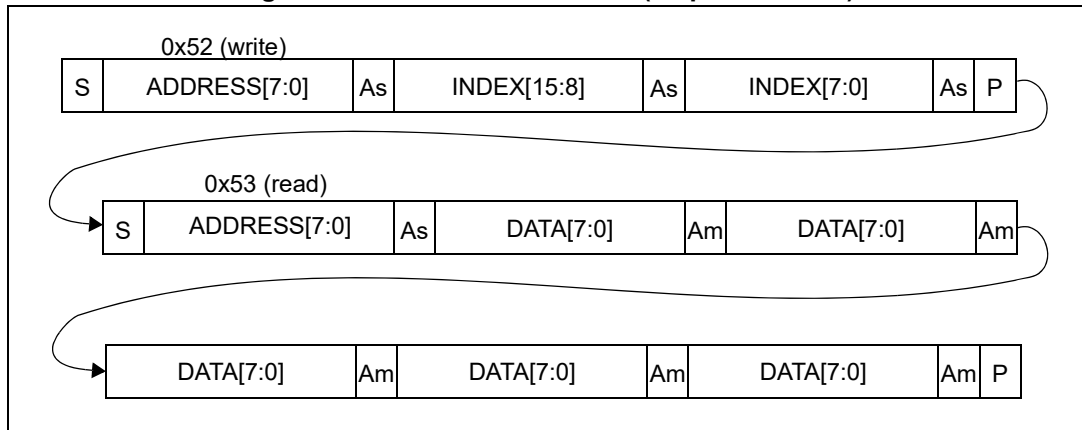

Figure 16. VL53L1X data format (sequential read)



4.1 I²C interface - timing characteristics

Timing characteristics are shown in [Table 10](#). Please refer to [Figure 17](#) for an explanation of the parameters used.

Table 10. I²C interface - timing characteristics for Fast mode (400 kHz)

Symbol	Parameter	Min.	Typ.	Max.	Unit
F _{I2C}	Operating frequency	0	-	400	kHz
t _{LOW}	Clock pulse width low	1.3	-	-	μs
t _{HIGH}	Clock pulse width high	0.6	-	-	
t _{SP}	Pulse width of spikes which are suppressed by the input filter	-	-	50	ns
t _{BUF}	Bus free time between transmissions	1.3	-	-	μs
t _{HD.STA}	Start hold time	0.26	-	-	μs
t _{SU.STA}	Start set-up time	0.26	-	-	
t _{HD.DAT}	Data in hold time	0	-	0.9	
t _{SU.DAT}	Data in set-up time	50	-	-	ns
t _R	SCL/SDA rise time	-	-	300	
t _F	SCL/SDA fall time	-	-	300	
t _{SU.STO}	Stop set-up time	0.6	-	-	μs
C _{i/o}	Input/output capacitance (SDA)	-	-	10	pF
C _{in}	Input capacitance (SCL)	-	-	4	
C _L	Load capacitance	-	125	400	

Figure 17. I²C timing characteristics

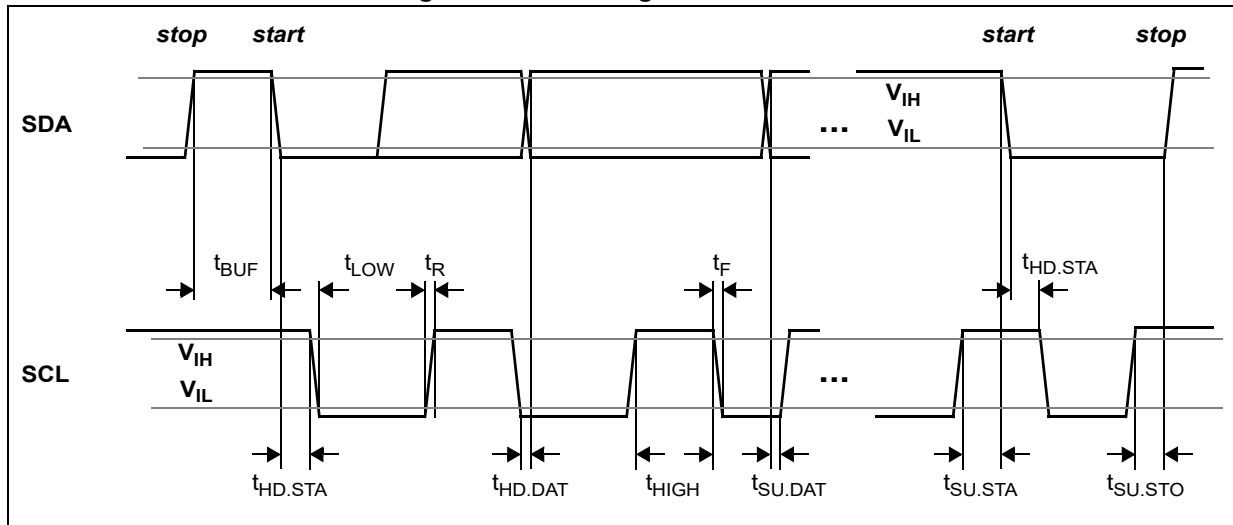

All timings are measured from either V_{IL} or V_{IH}.

4.2 I²C interface - reference registers

The registers shown in the table below can be used to validate the user I²C interface.

Table 11. Reference registers

Register name	Index	After fresh reset, without driver loaded
Model ID	0x010F	0xEA
Module Type	0x0110	0xCC
Mask Revision	0x0111	0x10

Note: The I²C read/writes can be 8, 16 or 32-bit. Multi-byte reads/writes are always addressed in ascending order with MSB first as shown in Table 12.

The customer must use the VL53L1X software driver for easy and efficient ranging operations to match performance and accuracy criteria. Hence full register details are not exposed. The customer should refer to the VL53L1X API user manual (UM2356).

Table 12. 32-bit register example

Register address	Byte
Address	MSB
Address + 1	..
Address + 2	..
Address + 3	LSB

5 Electrical characteristics

5.1 Absolute maximum ratings

Table 13. Absolute maximum ratings

Parameter	Min.	Typ.	Max.	Unit
AVDD	-0.5	-	3.6	V
SCL, SDA, XSHUT and GPIO1	-0.5	-	3.6	

Note: Stresses above those listed in [Table 13](#) may cause permanent damage to the device. This is a stress rating only and functional operation of the device at these or any other conditions above those indicated in the operational sections of the specification is not implied. Exposure to absolute maximum rating conditions for extended periods may affect device reliability.

5.2 Recommended operating conditions

Table 14. Recommended operating conditions ⁽¹⁾

Parameter	Min.	Typ.	Max.	Unit	
Voltage (AVDD)	2.6	2.8	3.5	V	
IO (IOVDD) ⁽²⁾	Standard mode	1.6	1.8		1.9
	2V8 mode ⁽³⁾⁽⁴⁾	2.6	2.8		3.5
Ambient temperature (normal operating)	-20		85	°C	

- There are no power supply sequencing requirements. The I/Os may be high, low, or floating when AVDD is applied. The I/Os are internally failsafe with no diode connecting them to AVDD
- XSHUT should be high level only when AVDD is on.
- SDA, SCL, XSHUT and GPIO1 high levels have to be equal to AVDD in 2V8 mode.
- The default driver mode is 1V8. 2V8 mode is programmable using device settings loaded by the driver. For more details please refer to the VL53L1X API user manual (UM2356).

5.3 ESD

The VL53L1X is compliant with ESD values presented in [Table 15](#)

Table 15. ESD performances

Parameter	Specification	Conditions
Human body model	JS-001-2012	± 2 kV, 1500 Ohms, 100 pF
Charged device model	JESD22-C101	± 500 V

5.4 Current consumption

Table 16. Power consumption at ambient temperature ⁽¹⁾

Parameter	Min.	Typ.	Max.	Unit
HW standby	3	5	7	uA
SW standby ⁽²⁾	4	6	9	
Inter measurement		20		
Ranging average (AVDD + AVDDVCSEL) ^{(3) (4)}		16	18	mA
Average power consumption at 10 Hz with 33 ms timing budget			20	mW
Average power consumption at 1 Hz with 20 ms timing budget when no target detected		0.9		
Average power consumption at 1 Hz with 20 ms timing budget when target detected		1.4		

1. All current consumption values include silicon process variations. Temperature and voltage are nominal conditions (23°C and AVDD 2v8). All values include AVDD and AVDDVCSEL.
2. In 2v8 (IOVDD) mode, pull ups have to be modified, then SW Standby consumption is increased by 0.6 µA.
3. Average consumption during ranging operation in long distance mode.
4. Peak current (including VCSEL) can reach 40 mA.

5.5 Digital I/O electrical characteristics

Table 17. Digital I/O electrical characteristics

	Symbol	Parameter	Min.	Typ.	Max.	Unit
Interrupt pin (GPIO1)	V _{IL}	Low level input voltage	-	-	0.3 IOVDD	V
	V _{IH}	High level input voltage	0.7 IOVDD		-	
	V _{OL}	Low level output voltage (I _{OUT} = 4 mA)	-		0.4	
	V _{OH}	High level output voltage (I _{OUT} = 4 mA)	IOVDD-0.4		-	
	F _{GPIO}	Operating frequency (C _{LOAD} = 20 pF)	0		108	MHz
I ² C interface (SDA/SCL)	V _{IL}	Low level input voltage	-0.5	-	0.6	V
	V _{IH}	High level input voltage	1.12		IOVDD+0.5	
	V _{OL}	Low level output voltage (I _{OUT} = 4 mA)	-		0.4	
	I _{IL} /I _{IH}	Leakage current ⁽¹⁾	-		10	µA
		Leakage current ⁽²⁾	-		0.15	

1. AVDD = 0 V
2. AVDD = 2.85 V; I/O voltage = 1.8 V

6 Outline drawing

Figure 18. Outline drawing (page 1/3)

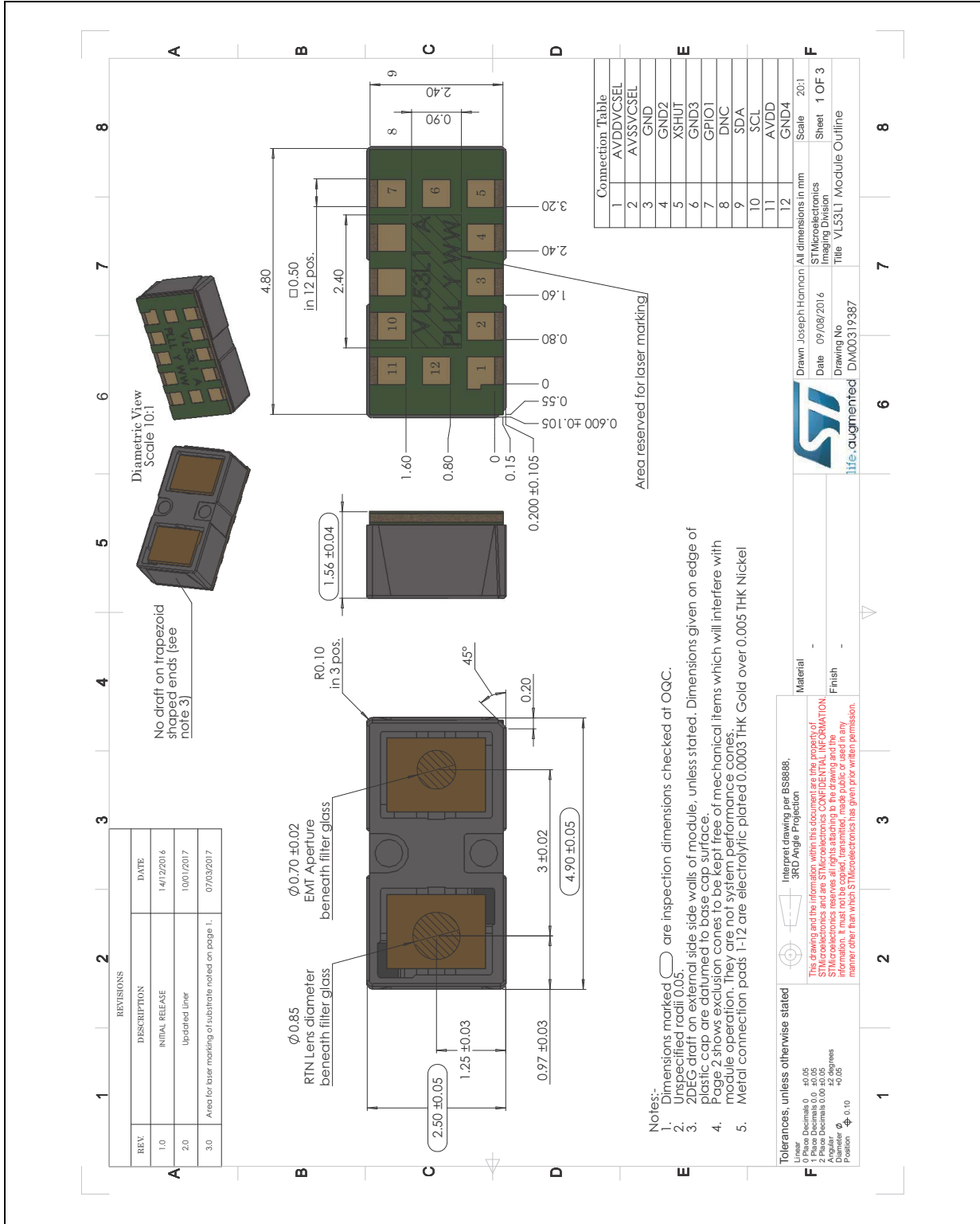
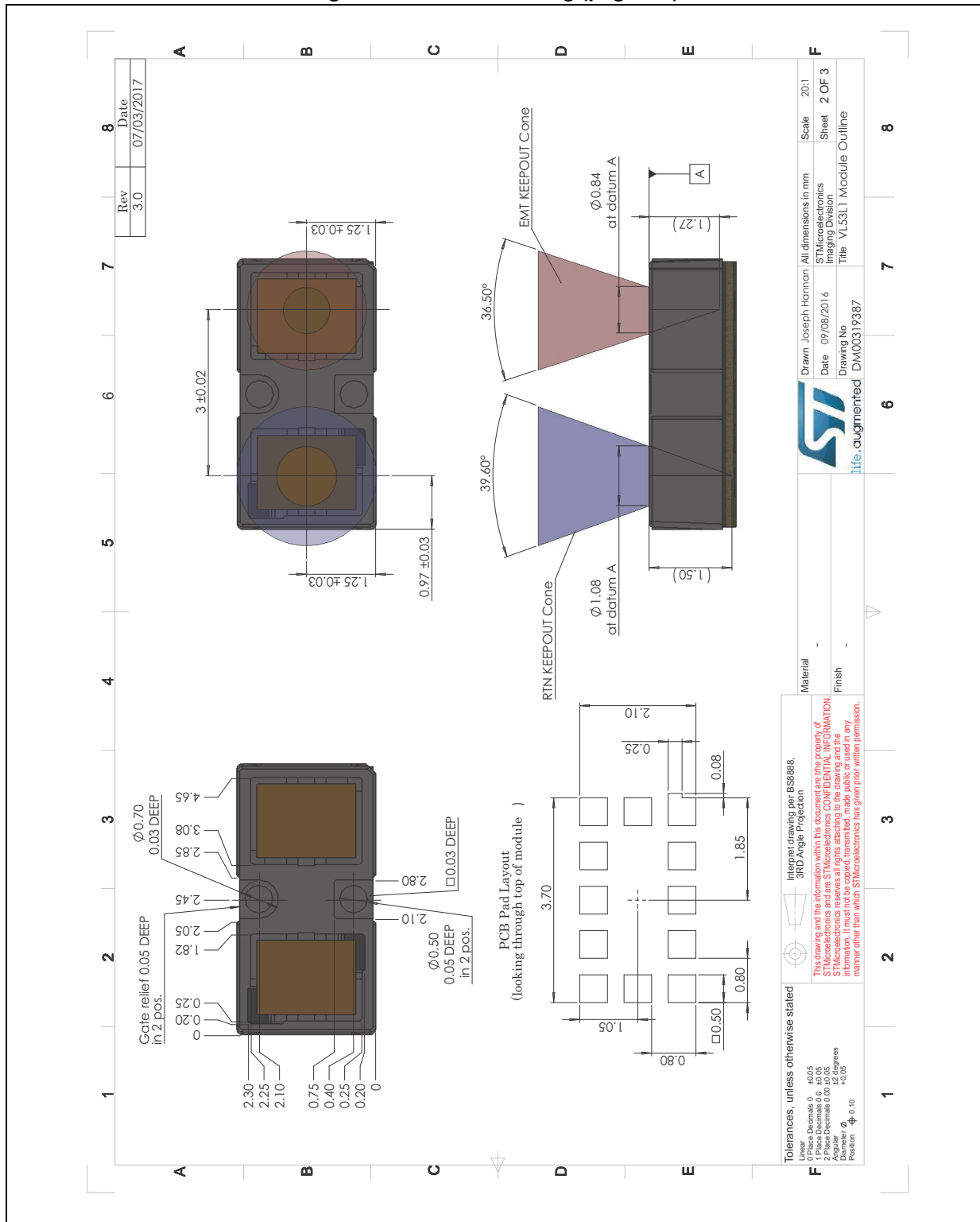

Figure 19. Outline drawing (page 2/3)



Rev	Date
3.0	07/03/2017

Material	Finish	Material	Finish
-	-	-	-
<p>Tolerances, unless otherwise stated</p> <p>Linear Decimals 0 ±0.05 1 Place Decimals 0 ±0.05 2 Place Decimals 0.00 ±0.05 Angles 0 ±0.05 Diameter Ø ±0.05 Position ±0.10</p>		<p>Internet drawing per BS8888, 3RD Angle Projection</p> <p>This drawing and the information within this document are the property of STMicroelectronics and are STMicroelectronics CONFIDENTIAL INFORMATION. STMicroelectronics reserves all rights attaching to the drawing and the information contained herein. No part of this drawing may be reproduced in any manner other than which STMicroelectronics has given prior written permission.</p>	
Drawn	Joseph Hanmon	All dimensions in mm	Scale 20:1
Date	07/03/2016	STMicroelectronics Imaging Division	Sheet 2 OF 3
Drawing No	DM00319387	Title	VL53L1 Module Outline



The VL53L1X module is delivered with a protective liner covering the top of the cap to protect the sensor from foreign material during the assembly process. It must be removed by the customer just before mounting the cover glass.

Figure 20. Outline drawing (page 3/3)

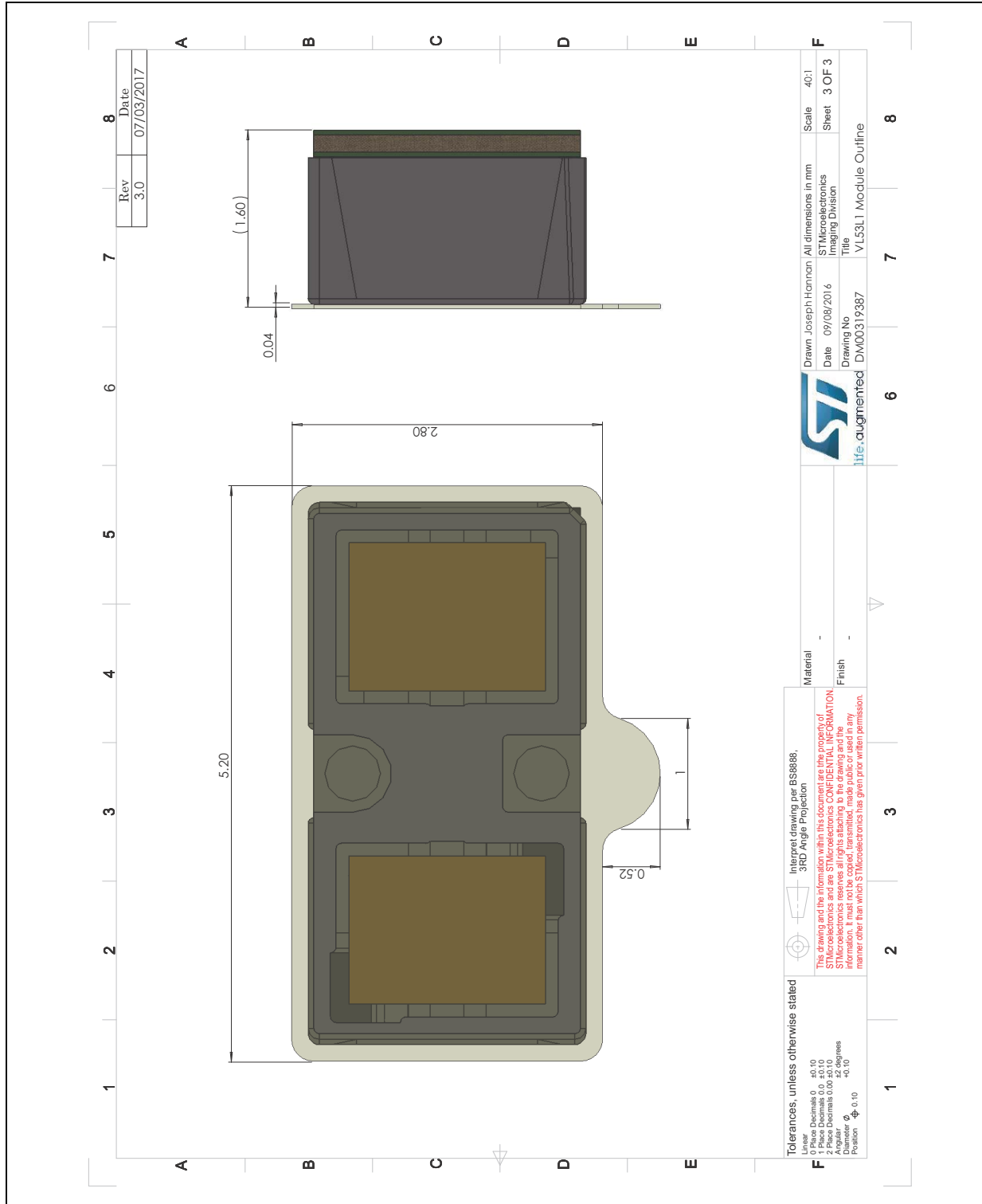

7 Laser safety considerations

The VL53L1X contains a laser emitter and corresponding drive circuitry. The laser output is designed to remain within Class 1 laser safety limits under all reasonably foreseeable conditions including single faults in compliance with IEC 60825-1:2014 (third edition).

The laser output remains within Class 1 limits as long as the STMicroelectronics' recommended device settings (driver settings) are used and the operating conditions specified are respected.

The laser output remains within Class 1 limits as long as the STMicroelectronic's recommended device settings are used and the operating conditions specified are respected (particularly the maximum timing budget, as described in the VL53L1X API user manual UM2356).

The laser output power must not be increased by any means and no optics should be used with the intention of focusing the laser beam.

Caution: Use of controls or adjustments or performance of procedures other than those specified herein may result in hazardous radiation exposure.

Figure 21. Class 1 laser product label



8 Packaging and labeling

8.1 Product marking

A 2-line product marking is applied on the backside of the module (i.e. on the substrate). The first line is the silicon product code, and the second line, the internal tracking code.

Figure 22. Example of prototype marking



8.2 Inner box labeling

The labeling follows the ST standard packing acceptance specification.

The following information will be on the inner box label:

- Assembly site
- Sales type
- Quantity
- Trace code
- Marking
- Bulk ID number

8.3 Packing

At customer/subcontractor level, it is recommended to mount the VL53L1X in a clean environment to avoid foreign material deposition.

To help avoid any foreign material contamination at phone assembly level the modules are shipped in a tape and reel format with a protective liner.

The packaging is vacuum-sealed and includes a desiccant.

The liner is compliant with reflow at 260°C. It must be removed during assembly of the customer device, just before mounting the cover glass.

8.4 Tape outline drawing

Figure 23. Tape outline drawing

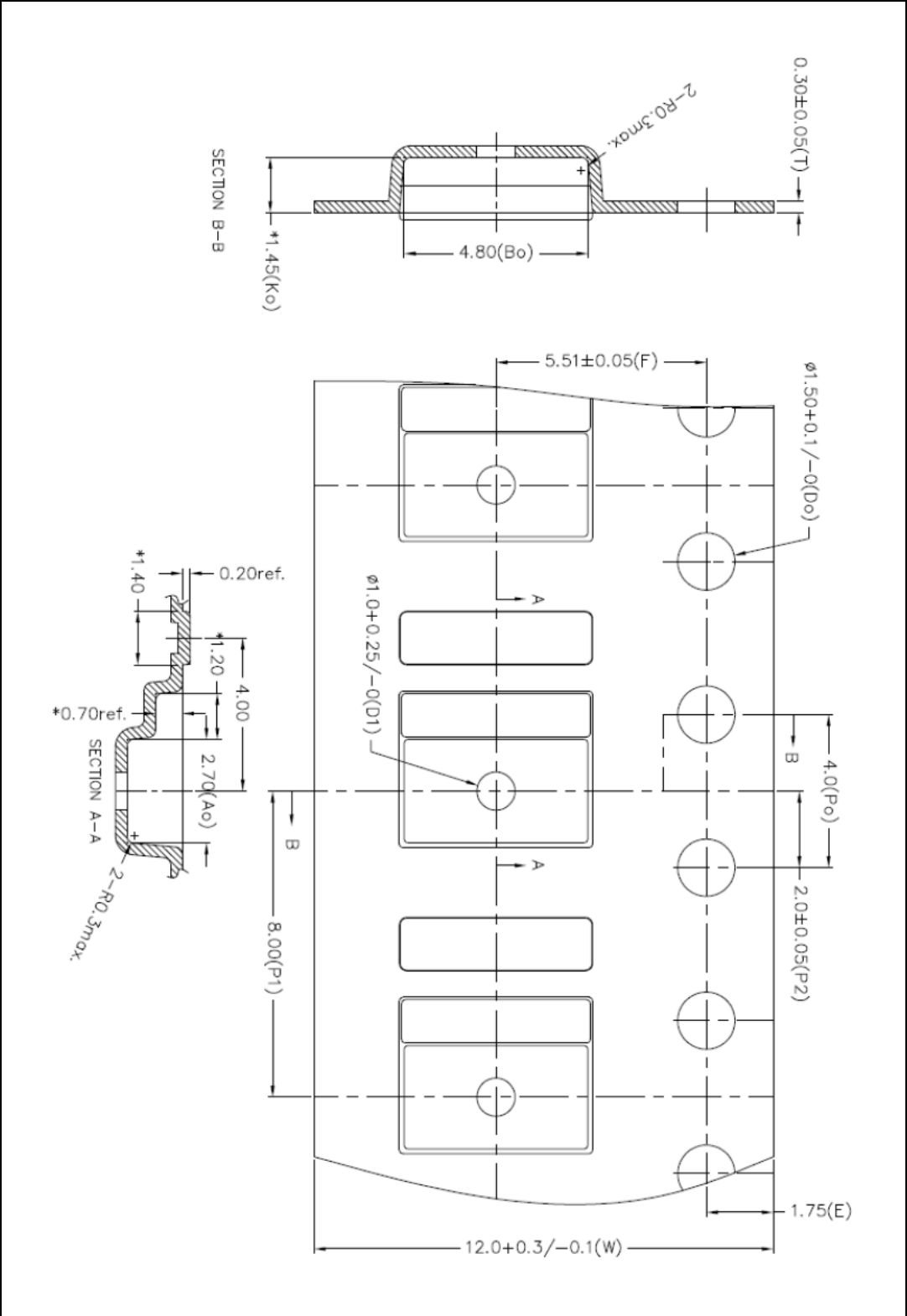

8.5 Pb-free solder reflow process

[Table 18](#) and [Figure 24](#) show the recommended and maximum values for the solder profile.

Customers have to tune the reflow profile depending on the PCB, solder paste, and material used. We expect customers to follow the recommended reflow profile, which is specifically tuned for VL53L1X package.

For any reason, if a customer must perform a reflow profile which is different from the recommended one (especially peak >240 °C), this new profile must be qualified by the customer at their own risk. In any case, the profile has to be within the “maximum” profile limit described in [Table 18](#).

Table 18. Recommended solder profile

Parameters	Recommended	Maximum	Units
Minimum temperature (T_S min)	130	150	°C
Maximum temperature (T_S max)	200	200	°C
Time t_S (T_S min to T_S max)	90-110	60 - 120	s
Temperature (T_L)	217	217	°C
Time (t_L)	55-65	55 - 65	s
Ramp up	2	3	°C/s
Temperature (T_{p-10})	-	235	°C
Time (t_p)	-	10	s
Ramp up	-	3	°C/s
Peak temperature (T_p)	240	245	°C
Time to peak	300	300	s
Ramp down (peak to T_L)	-4	-6	°C/s

Figure 24. Solder profile

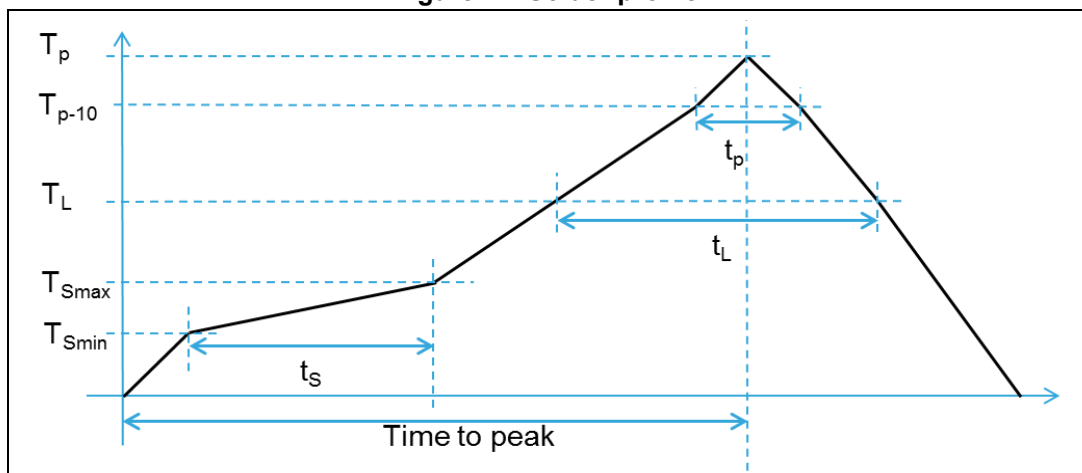

Note: Temperature mentioned in [Table 18](#) is measured at the top of the VL53L1X package.

Note: The component should be limited to a maximum of three passes through this solder profile.

Note: As the VL53L1X package is not sealed, only a dry reflow process should be used (such as convection reflow). Vapor phase reflow is not suitable for this type of optical component. The VL53L1X is an optical component and as such, it should be treated carefully. This would typically include using a 'no-wash' assembly process

8.6 Handling and storage precautions

8.6.1 Shock precaution

Sensor modules house numerous internal components that are susceptible to shock damage. If a unit is subject to excessive shock, is dropped on the floor, or a tray/reel of units is dropped on the floor, it must be rejected, even if no apparent damage is visible.

8.6.2 Part handling

Handling must be done with non-marring ESD safe carbon, plastic, or teflon tweezers. Ranging modules are susceptible to damage or contamination. The customer is advised to use a clean assembly process after removing the tape from the parts, and until a protective cover glass is mounted.

8.6.3 Compression force

A maximum compressive load of 25 N should be applied on the module.

8.6.4 Moisture sensitivity level

Moisture sensitivity is level 3 (MSL) as described in IPC/JEDEC JSTD-020-C

8.7 Storage temperature conditions

Table 19. Recommended storage conditions

Parameter	Min.	Typ.	Max.	Unit
Temperature (storage)	-40	23	85	°C

9 Ordering information

Table 20. Order codes

Sales type	Package	Packing	Minimum order quantity
VL53L1CXV0FY/1	Optical LGA12 with liner	Tape and reel	3600 pcs

10 Acronyms and abbreviations

Table 21. Acronyms and abbreviations

Acronym/abbreviation	Definition
ESD	Electrostatic discharge
I ² C	Inter-integrated circuit (serial bus)
NVM	Non volatile memory
SPAD	Single photon avalanche diode
FoV	Field of view
VCSEL	Vertical cavity surface emitting laser

11 ECOPACK[®]

In order to meet environmental requirements, ST offers these devices in different grades of ECOPACK[®] packages, depending on their level of environmental compliance. ECOPACK[®] specifications, grade definitions and product status are available at: www.st.com. ECOPACK[®] is an ST trademark.

Note: The ECOPACK[®] grade for VL53L1X is ECOPACK[®]2.

12 Revision history

Table 22. Document revision history

Date	Revision	Changes
08-Feb-2018	1	Initial release
14-Feb-2018	2	Updated <i>Applications</i> and <i>Description</i>
29-Nov-2018	3	Updated <i>Features</i> : I ² C interface up to 400 kHz <i>Table 10</i> : updated t_{BUF} , t_R , and t_F . <i>Table 18</i> : modified Time (t_p-10) to Time(t_p) Modified <i>Figure 18</i> , <i>Figure 19</i> , and <i>Figure 20</i> Updated <i>Section 7: Laser safety considerations</i>
13-Oct-2021	4	<i>Section 4: Control interface</i> : replaced “camera module” with “Time-of-Flight” sensor.
01-Apr-2022	5	Updated <i>Figure 23: Tape outline drawing</i>
24-Jun-2022	6	Remove “™” form document title Updated <i>Figure 15: VL53L1X data format (sequential write)</i>