

Overview

KEMET's VP series of low and medium voltage plastic-encapsulated varistors are designed to protect electronic equipment against high voltage surges in the low and medium voltage region. They offer direct surface mount equivalents to leaded disc varistors of 5 and 7 mm sizes. The thermoplastic encapsulation is non-flammable according to the standard UL 94 V-0. Contacts are made of tinned copper sheet.

These transient voltage suppressors cover an operating voltage V_{rms} from 60 V to 300 V, featuring maximum surge currents from 400 – 1,200 A.

Benefits

- Surface mount form factor
- Operating ambient temperature of -40°C to +85°C
- Operating voltage range of 85 – 385 VDC
- Operating voltage (V_{rms}) of 60 – 300 V
- Available case sizes: 3225 and 4032
- Dimensional and weight savings on the board
- Non-flammable thermoplastic encapsulation according to the standard UL 94 V-0
- RoHS 2 2011/65/EC, REACH compliant

Applications

Typical applications include medical instruments, integrated circuits and transistors, mobile communication, white goods, entertainment electronics, lighting ballast, as well as protection of low and medium voltage boards, remote control and electrical counters and applications that are exposed to humidity.



Ordering Information

VP	3225	K	101	R	011
Series	Chip Size Code	Tolerances	Rated Peak Single Pulse Transient Current (A)	Packaging/Termination	Maximum Continuous Working Voltage (Vrms AC)
Varistor SMD 85°C Plastic Encapsulated	3225 = 3225 4032 = 4032	K = 10%	401 = 400 122 = 1,200 (First two digits represent significant figures. Third digit specifies number of zeros.)	R = Reel 330 mm	060 = 60 075 = 75 095 = 95 115 = 115 130 = 130 140 = 140 150 = 150 175 = 175 230 = 230 250 = 250 275 = 275 300 = 300

Dimensions – Millimeters

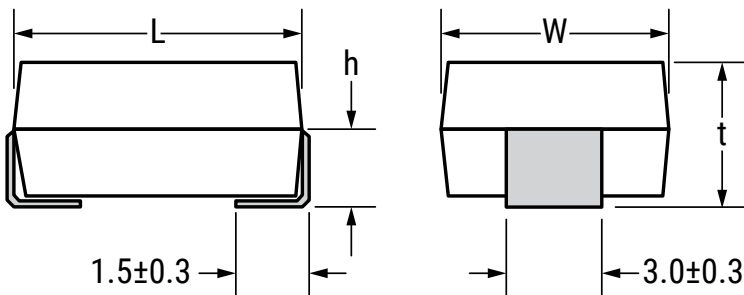

Size Code	Voltage range V	L ±0.5 mm	W ±0.4 mm	h ±0.3 mm	t ±0.3 mm
3225	11 – 150	8.0	6.3	1.7	3.4
3225	175 – 300	8.0	6.3	2.3	4.7
4032	11 – 300	10.0	8.0	2.3	4.7

Environmental Compliance

RoHS 2 2011/65/EC, REACH

Performance Characteristics

Continuous	Units	Value
Steady State Applied Voltage		
DC Voltage Range (V_{dc})	V	85 – 385
AC Voltage Range (V_{rms})	V	60 – 300
Transient		
Non-Repetitive Surge Current, 8/20 μ s Waveform (I_{max})	A	400 – 1,200
Non-Repetitive Surge Energy, 10/1,000 μ s Waveform (W_{max})	J	3 – 30
Operating Ambient Temperature	°C	-40 to +85
Storage Temperature Range (mounted components)	°C	-40 to +125
Threshold Voltage Temperature Coefficient	%/°C	< +0.05
Response Time	ns	< 5
Climatic Category		40/85/56

Qualifications

Reliability Parameter	Test	Tested According to	Condition to be Satisfied after Testing
AC/DC Bias Reliability	AC/DC Life Test	CECC 42200, Test 4.20 or IEC 1051-1, Test 4.20. AEC-Q200 Test 8 – 1,000 hours at UCT	$ \delta_{Vn} (1 \text{ mA}) < 10\%$
Pulse Current Capability	I_{max} 8/20 μ s	CECC 42200, Test C 2.1 or IEC 1051-1, Test 4.5. 10 pulses in the same direction at 2 pulses per minute at maximum peak current for 10 pulses	$ \delta_{Vn} (1 \text{ mA}) < 10\%$ no visible damage
Pulse Energy Capability	W_{max} 10/1,000 μ s	CECC 42200, Test C 2.1 or IEC 1051-1, Test 4.5. 10 pulses in the same direction at 1 pulses every 2 minutes at maximum peak current for 10 pulses	$ \delta_{Vn} (1 \text{ mA}) < 10\%$ no visible damage
WLD Capability	WLD x 10	ISO 7637, Test pulse 5, 10 pulses at rate 1 per minute	$ \delta_{Vn} (1 \text{ mA}) < 15\%$ no visible damage
V_{jump} Capability	V_{jump} 5 minutes	Increase of supply voltage to $V \geq V_{jump}$ for 1 minute	$ \delta_{Vn} (1 \text{ mA}) < 15\%$ no visible damage

Qualifications cont'd

Reliability Parameter	Test	Tested According to	Condition to be Satisfied after Testing
Environmental and Storage Reliability	Climatic Sequence	CECC 42200, Test 4.16 or IEC 1051-1, Test 4.17. a) Dry heat, 16 hours, UCT, Test Ba, IEC 68-2-2 b) Damp heat, cyclic, the first cycle: 55°C, 93% RH, 24 hours, Test Db 68-2-4 c) Cold, LCT, 2 hours Test Aa IEC 68-2-1 d) Damp heat cyclic, remaining 5 cycles: 55°C, 93% RH, 24 hour/cycle, Test Bd, IEC 68-2-30	$ \delta_{vn} (1 \text{ mA}) < 10\%$
	Thermal Shock	CECC 42200, Test 4.12, Test Na, IEC 68-2-14, AEC-Q200 Test 16, 5 cycles UCT/LCT, 30 minutes	$ \delta_{vn} (1 \text{ mA}) < 10\%$ no visible damage
	Steady State Damp Heat	CECC 42200, Test 4.17, Test Ca, IEC 68-2-3, AEC-Q200 Test 6, 56 days, 40°C, 93% RH. AEC-Q200 Test 7: Bias, RH, T all at 85.	$ \delta_{vn} (1 \text{ mA}) < 10\%$
	Storage Test	IEC 68-2-2, Test Ba, AEC-Q200 Test 3, 1,000 hours at maximum storage temperature	$ \delta_{vn} (1 \text{ mA}) < 5\%$
Mechanical Reliability	Solderability	CECC 42200, Test 4.10.1, Test Ta IEC 68-2-20 solder bath and reflow method	Solderable at shipment and after 1 year of storage, criteria > 95% must be covered by solder for reflow meniscus
	Resistance to Soldering Heat	CECC 42200, Test 4.10.2, Test Tb, IEC 68-2-20 solder bath and reflow method	$ \delta_{vn} (1 \text{ mA}) < 5\%$
	Terminal Strength	JIS-C-6429, App. 1, 18 N for 60 seconds – same for AEC-Q200 Test 22	no visual damage
	Board Flex	JIS-C-6429, App. 2, 2 mm minimum AEC-Q200 test 21 – Board flex: 2 mm flex minimum	$ \delta_{vn} (1 \text{ mA}) < 2\%$ no visible damage
	Vibration	CECC 42200, Test 4.15, Test Fc, IEC 68-2-6, AEC-Q200 Test 14. Frequency range 10 – 55 Hz (AEC: 10 – 2,000 Hz) Amplitude 0.75 m/s ² or 98 m/s ² (AEC: 5 G for 20 minutes) Total duration 6 hours (3 x 2 hours) (AEC: 12 cycles each of 3 directions) Waveshape – half sine	$ \delta_{vn} (1 \text{ mA}) < 10\%$ no visible damage
Mechanical Shock	CECC 42200, Test 4.14, Test Ea, IEC 68-2-27, AEC-Q200 Test 13. Acceleration = 490 m/s ² (AEC: MIL-STD-202-Method 213), Pulse duration = 11 ms, Waveshape – half sine; Number of shocks = 3 x 6	$ \delta_{vn} (1 \text{ mA}) < 10\%$ no visible damage	
Electrical Transient Conduction	ISO-7637-1 Pulses	AEC-Q200 Test 30: Test pulses 1 to 3. Also other pulses – freestyle.	$ \delta_{vn} (1 \text{ mA}) < 10\%$ no visible damage

Table 1 – Ratings & Part Number Reference

KEMET Part Number	h ±0.3 (mm)	L ±0.5 (mm)	W ±0.4 (mm)	t ±0.3 (mm)	V _{rms}	VDC	V _n 1 mA	V _c	I _c	W _{max} 10/1,000 μs (J)	P _{max} (W)	I _{max} 8/20 μs (A)	C _{typ} at 1 kHz (pF)
VP3225K401R060	1.7	8.0	6.3	3.4	60	85	100	165	5	3.0	0.1	400	330
VP4032K122R060	2.3	10.0	8.0	4.7	60	85	100	165	10	7.0	0.25	1,200	680
VP3225K401R075	1.7	8.0	6.3	3.4	75	100	120	200	5	4.0	0.1	400	270
VP4032K122R075	2.3	10.0	8.0	4.7	75	100	120	200	10	9.0	0.25	1,200	550
VP3225K401R095	1.7	8.0	6.3	3.4	95	125	150	250	5	6.0	0.1	400	220
VP4032K122R095	2.3	10.0	8.0	4.7	95	125	150	250	10	11.0	0.25	1,200	440
VP3225K401R115	1.7	8.0	6.3	3.4	115	150	180	300	5	6.5	0.1	400	180
VP4032K122R115	2.3	10.0	8.0	4.7	115	150	180	300	10	13.0	0.25	1,200	360
VP3225K401R130	1.7	8.0	6.3	3.4	130	170	205	340	5	7.0	0.1	400	160
VP4032K122R130	2.3	10.0	8.0	4.7	130	170	205	340	10	15.0	0.25	1,200	320
VP3225K401R140	1.7	8.0	6.3	3.4	140	180	220	360	5	7.5	0.1	400	150
VP4032K122R140	2.3	10.0	8.0	4.7	140	180	220	360	10	18.0	0.25	1,200	300
VP3225K401R150	1.7	8.0	6.3	3.4	150	200	240	395	5	9.0	0.1	400	140
VP4032K122R150	2.3	10.0	8.0	4.7	150	200	240	395	10	18.5	0.25	1,200	280
VP3225K401R175	1.7	8.0	6.3	4.7	175	225	270	455	5	9.5	0.1	400	120
VP4032K122R175	2.3	10.0	8.0	4.7	175	225	270	455	10	21.0	0.25	1,200	250
VP3225K401R230	1.7	8.0	6.3	4.7	230	300	360	595	5	10.0	0.1	400	95
VP4032K122R230	2.3	10.0	8.0	4.7	230	300	360	595	10	23.0	0.25	1,200	190
VP3225K401R250	1.7	8.0	6.3	4.7	250	320	390	650	5	11.0	0.1	400	80
VP4032K122R250	2.3	10.0	8.0	4.7	250	320	390	650	10	25.0	0.25	1,200	180
VP3225K401R275	1.7	8.0	6.3	4.7	275	350	430	710	5	13.0	0.1	400	75
VP4032K122R275	2.3	10.0	8.0	4.7	275	350	430	710	10	29.0	0.25	1,200	160
VP3225K401R300	1.7	8.0	6.3	4.7	300	385	470	775	5	15.0	0.1	400	70
VP4032K122R300	2.3	10.0	8.0	4.7	300	385	470	775	10	30.0	0.25	1,200	150
KEMET Part Number	h ±0.3 mm	L ±0.5 mm	W ±0.4 mm	t ±0.3 mm	V _{rms} V	V _{dc} V	V _n 1 mA V	V _c V	I _c A	W _{max} 10/1,000 μs J	P max W	I _{max} 8/20 μs A	C _{typ} @ 1 kHz pF

Soldering

Popular soldering techniques used for surface mounted components are Wave and Infrared Reflow processes. Both processes can be performed with Pb-containing or Pb-free solders. The termination option available for these soldering techniques is Barrier Type End Terminations.

End Termination	Designation	Recommended and Suitable for	Component RoHS Compliant
Ni Sn Barrier Type End Termination	Ni R1	Pb-containing and Pb-free soldering	Yes

Wave Soldering – this process is generally associated with discrete components mounted on the underside of printed circuit boards, or for large top-side components with bottom-side mounting tabs to be attached, such as the frames of transformers, relays, connectors, etc. SMD varistors to be wave soldered are first glued to the circuit board, usually with an epoxy adhesive. When all components on the PCB have been positioned and an appropriate time is allowed for adhesive curing, the completed assembly is then placed on a conveyor and run through a single, double wave process.

Infrared Reflow Soldering – these reflow processes are typically associated with top-side component placement. This technique utilizes a mixture of adhesive and solder compounds (and sometimes fluxes) that are blended into a paste. The paste is then screened onto PCB soldering pads specifically designed to accept a particular sized SMD component. The recommended solder paste wet layer thickness is 100 to 300 µm. Once the circuit board is fully populated with MD components, it is placed in a reflow environment, where the paste is heated to slightly above its eutectic temperature. When the solder paste reflows, the SMD components are attached to the solder pads.

Solder Fluxes – solder fluxes are generally applied to populated circuit boards to clean oxides forming during the heating process and to facilitate the flowing of the solder. Solder fluxes can be either a part of the solder paste compound or can be separate materials, usually fluids. Recommended fluxes are:

- Non-activated (R) fluxes, whenever possible
- Mildly activated (RMA) fluxes of class L3CN
- Class ORLO

Activated (RA), water soluble or strong acidic fluxes with a chlorine content > 0.2 wt. % are NOT RECOMMENDED. The use of such fluxes could create high leakage current paths along the body of the varistor components. When a flux is applied prior to wave soldering, it is important to completely dry any residual flux solvents prior to the soldering process.

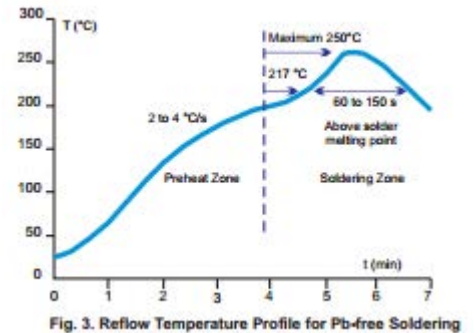
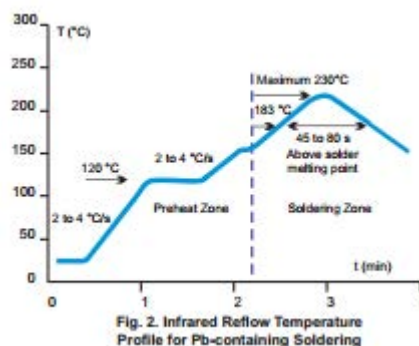
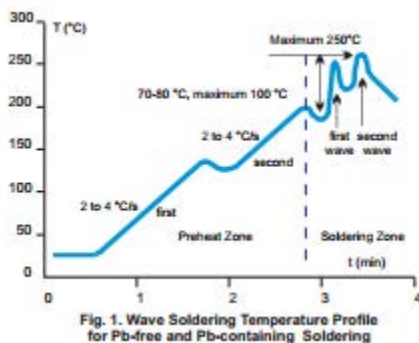

Thermal Shock – to avoid the possibility of generating stresses in the varistor chip due to thermal shock, a preheat stage to within 100°C of the peak soldering process temperature is recommended. Additionally, SMD varistors should not be subjected to a temperature gradient greater than 4°C/second, with an ideal gradient being 2°C/second. Peak temperatures should be controlled. Wave and Reflow soldering conditions for SMD varistors with Pb-containing solders are shown in Fig. 1 and 2 respectively, while Wave and Reflow soldering conditions for SMD varistors with Pb-free solders are shown in Figures 1 and 3

Soldering cont'd

Whenever several different types of SMD components are being soldered, each having a specific soldering profile, the soldering profile with the least heat and the minimum amount of heating time is recommended. Once soldering has been completed, it is necessary to minimize the possibility of thermal shock by allowing the hot PCB to cool to less than 50°C before cleaning.

Inspection Criteria – the inspection criteria to determine acceptable solder joints, when Wave or Infrared Reflow processes are used, will depend on several key variables, principally termination material process profiles.

Pb-containing Wave and IR Reflow Soldering – typical “before” and “after” soldering results for Barrier Type End Terminations can be seen in Fig. 4. Barrier type terminated varistors form a reliable electrical contact and metallurgical bond between the end terminations and the solder pads. The bond between these two metallic surfaces is exceptionally strong and has been tested by both vertical pull and lateral (horizontal) push tests. The results exceed established industry standards for adhesion.

The solder joint appearance of a barrier type terminated varistor shows that solder forms a metallurgical junction with the thin tin-alloy (over the barrier layer), and due to its small volume “climbs” the outer surface of the terminations, the meniscus will be slightly lower. This optical appearance should be taken into consideration when programming visual inspection of the PCB after soldering.

Ni Sn Barrier Type End Terminations

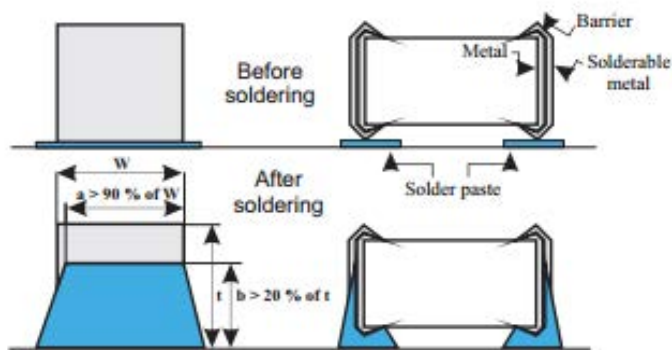

Figure 4: Soldering Criterion in case of Wave and IR Reflow Pb-containing Soldering

Pb-free Wave and IR Reflow Soldering – typical “before” and “after” soldering results for Barrier Type End Terminations are given in a phenomenon known as “mirror” or “negative” meniscus. Solder forms a metallurgical junction with the entire volume of the end termination, i.e. it diffuses from pad to end termination across the inner side, forming a “mirror” or “negative” meniscus. The height of the solder penetration can be clearly seen on the end termination and is always 30% higher than the chip height.

Soldering cont'd

Solder Test and Retained Samples – reflow soldering test based on J-STD-020D.1 and soldering test by dipping based on IEC 60068-2 for Pb-free solders are performed on each production lot as shown in the following chart. Test results and accompanying samples are retained for a minimum of two (2) years. The solderability of a specific lot can be checked at any time within this period should a customer require this information.

Test	Resistance to Flux	Solderability	Static leaching (Simulation of Reflow Soldering)	Dynamic Leaching (Simulation of Wave Soldering)
Parameter				
Soldering method	Dipping	Dipping	Dipping	Dipping with agitation
Flux	L3CN, ORLO	L3CN, ORLO, R	L3CN, ORLO, R	L3CN, ORLO, R
Pb Solder	62 Sn/36 Pb/2 Ag			
Pb Soldering temperature (°C)	235±5	235±5	260±5	235±5
Pb-FREE Solder	Sn96/Cu0,4-0,8/3-4Ag			
Pb-FREE Soldering Temperature (°C)	250±5	250±5	280±5	250±5
Soldering Time (s)	2	210	10	> 15
Burn-in Conditions	VDC _{max} 48 h			
Acceptance Criterion	dVn < 5%, i _{dc} must stay unchanged	> 95% of end termination must be covered by solder	> 95% of end termination must be intact and covered by solder	> 95% of end termination must be intact and covered by solder

Rework Criteria Soldering Iron – unless absolutely necessary, the use of soldering irons is NOT recommended for reworking varistor chips. If no other means of rework is available, the following criteria must be strictly followed:

- Do not allow the tip of the iron to directly contact the top of the chip
- Do not exceed the following soldering iron specifications:
 - Output Power: 30 Watts maximum
 - Temperature of Soldering Iron Tip: 280°C maximum
 - Soldering Time: 10 Seconds maximum

Storage Conditions – SMD varistors should be used within 1 year of shipment from factory to avoid possible soldering problems caused by oxidized terminals. The storage environment should be controlled, with humidity less than 40% and temperature between -25 and 45 °C. Varistor chips should always be stored in their original packaged unit.

Soldering Pad Configuration

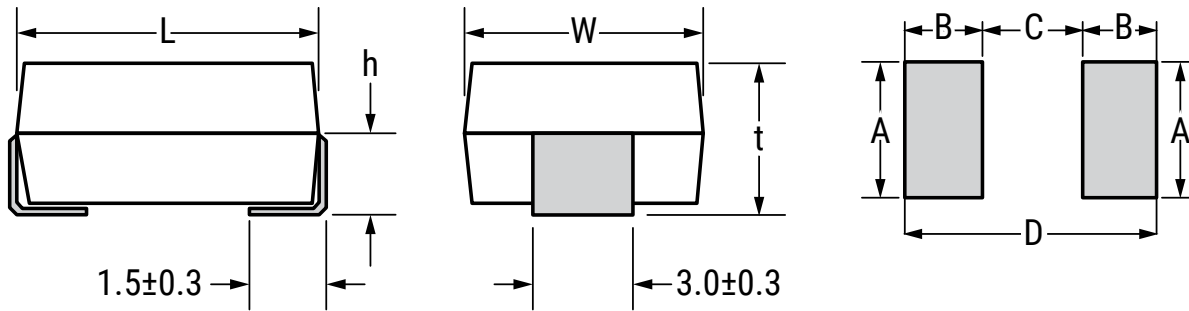

Size	Voltage range V	L ±0.5 mm	W ±0.4 mm	h ±0.3 mm	t ±0.3 mm	A (mm)	B (mm)	C (mm)	D (mm)
3225	11 – 150	8.0	6.3	1.7	3.4	3.5	2.9	4.5	10.3
3225	175 – 300	8.0	6.3	2.3	4.7	3.5	2.9	4.5	10.3
4032	11 – 300	10.0	8.0	2.3	4.7	3.5	2.9	6.5	12.3

Packaging

Voltage Range (V)	Chip Size	
	3225	4032
	Reel Size	
< 175	1,500	1,000
> 175	1,000	1,000

Construction

Current Below 50 V

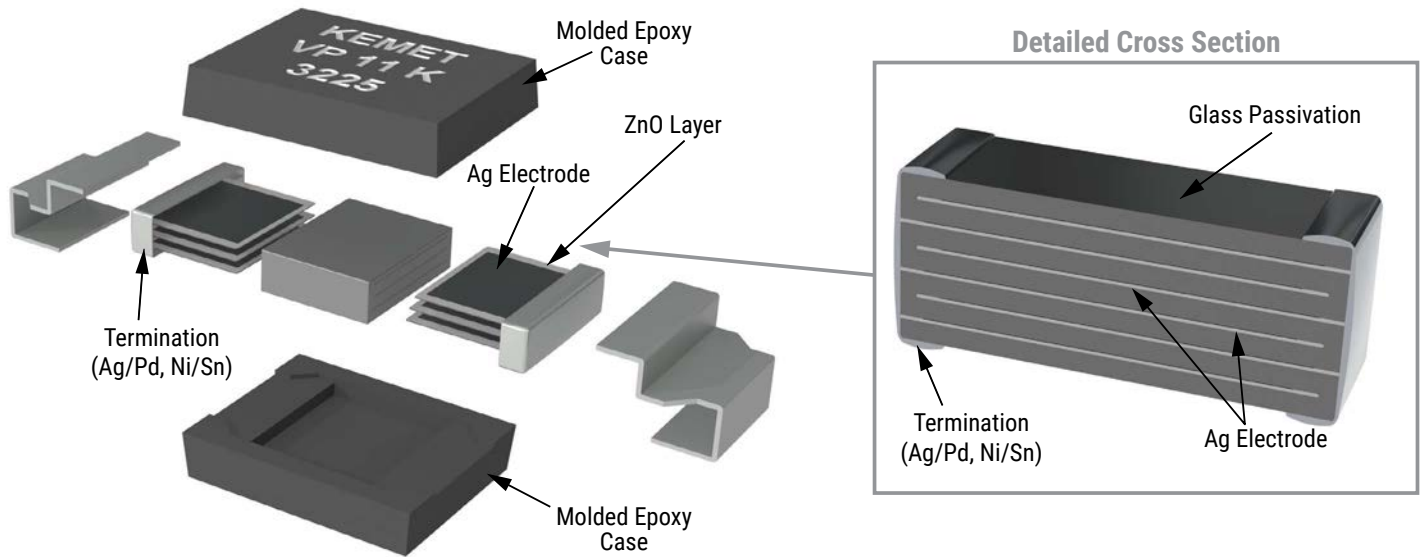

Current Equal or Greater than 50 V

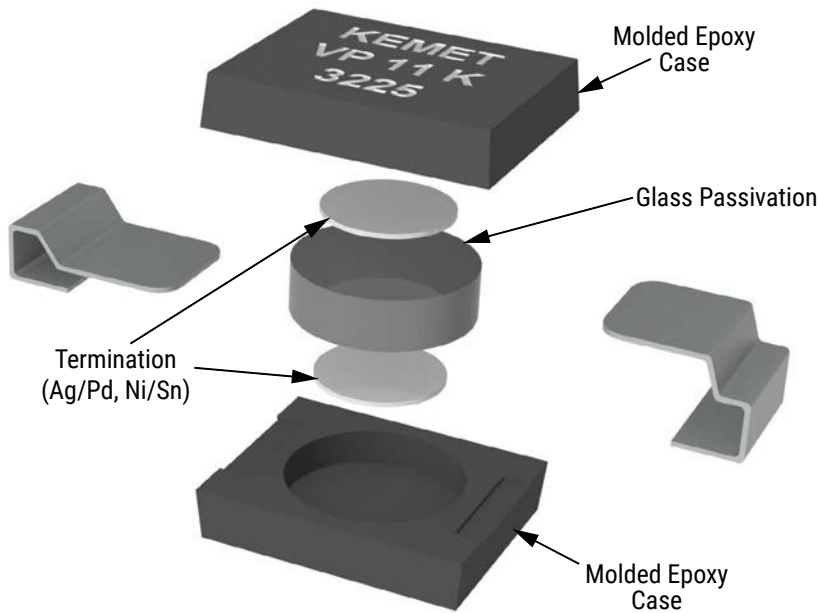

Marking

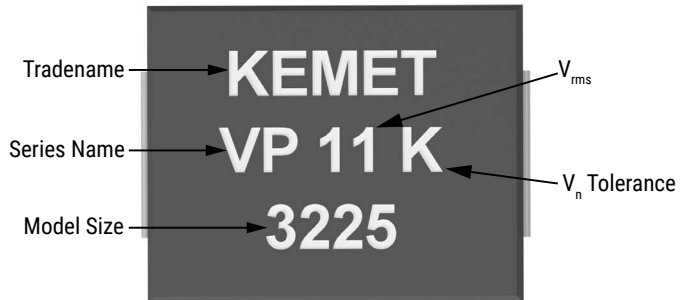

Taping & Reel Specifications



Tape Size (mm)	16 mm	
	3225	4032
A_0	7.8	10.8
B_0	3.7	3.7
K_0 Maximum	12.1	12.1
B_1 Maximum	1.5	1.5
D_1 Minimum	14.25	14.25
E_2 Minimum	12.0	12.0
P_1	7.5	7.5
F	16.0	16.0
W	9.5	9.5
T_2 Maximum	$16.4+2$	$16.4+2$
W_1	$12.4+2$	$12.4+2$
W_2 Maximum	22.4	22.4
W_3	15.9 - 9.4	15.9 - 19.4
A	330	330

Terms and Definitions

Term	Symbol	Definition
Rated AC Voltage	V_{rms}	Maximum continuous sinusoidal AC voltage (< 5% total harmonic distortion) which may be applied to the component under continuous operation conditions at 25°C
Rated DC Voltage	V_{dc}	Maximum continuous DC voltage (< 5% ripple) which may be applied to the component under continuous operating conditions at 25°C
Supply Voltage	V	The voltage by which the system is designated and to which certain operating characteristics of the system are referred; $V_{rms} = 1, 1 \times V$
Leakage Current	I_{dc}	The current passing through the varistor at Vdc and at 25°C or at any other specified temperature
Varistor Voltage	V_n	Voltage across the varistor measured at a given reference current In
Reference Current	I_n	Reference current = 1 mA DC
Clamping Voltage Protection Level	V_c	The peak voltage developed across the varistor under standard atmospheric conditions, when passing an 8/20 μ s class current pulse
Class Current	I_c	A peak value of current which is 1/10 of the maximum peak current for 100 pulses at two per minute for the 8/20 μ s pulse
Voltage Clamping Ratio	V_c/V_{app}	A figure of merit measure of the varistor clamping effectiveness as defined by the symbols V_c/V_{app} , where ($V_{app} = V_{rms}$ or V_{dc})
Jump Start Transient	V_{jump}	The jump start transient resulting from the temporary application of an overvoltage in excess of the rated battery voltage. The circuit power supply may be subjected to a temporary overvoltage condition due to the voltage regulation failing or it may be deliberately generated when it becomes necessary to boost start the car
Rated Single Pulse Transient Energy	W_{max}	Energy which may be dissipated for a single 10/1,000 μ s pulse of a maximum rated current, with rated AC voltage or rated DC voltage also applied, without causing device failure
Load Dump Transient	WLD	Load Dump is a transient which occurs in an automotive environment. It is an exponentially decaying positive voltage which occurs in the event of a battery disconnect while the alternator is still generating charging current with other loads remaining on the alternator circuit at the time of battery disconnect
Rated Peak Single Pulse Transient Current	I_{max}	Maximum peak current which may be applied for a single 8/20 μ s pulse, with, rated line voltage also applies, without causing device failure
Rated Transient Average Power Dissipation	P	Maximum average power which may be dissipated due to a group of pulses occurring within a specified isolated time period, without causing device failure at 25°C
Capacitance	C	Capacitance between two terminals of the varistor measured at 1 kHz
Response Time	tr	The time lag between application of a surge and varistor's "turn-on" conduction action
Varistor Voltage Temperature Coefficient	TC	$(V_n \text{ at } 85^\circ\text{C} - V_n \text{ at } 25^\circ\text{C}) / (V_n \text{ at } 25^\circ\text{C}) \times 60^\circ\text{C} \times 100$
Insulation Resistance	IR	Minimum resistance between shorted terminals and varistor surface
Isolation Voltage		The maximum peak voltage which may be applied under continuous operating conditions between the varistor terminations and any conducting mounting surface
Operating Temperature		The range of ambient temperature for which the varistor is designed to operate continuously as defined by the temperature limits of its climatic category
Climatic Category	LCT/UCT/DHD	UCT = Upper Category Temperature – the maximum ambient temperature for which a varistor has been designed to operate continuously, LCT = Lower Category Temperature – the minimum ambient temperature at which a varistor has been designed to operate continuously DHD = Dump Heat Test Duration
Storage Temperature		Storage temperature range without voltage applied