

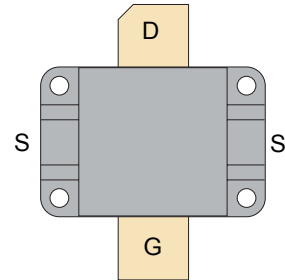

RF POWER VERTICAL MOSFET

The VRF157FL is a gold-metallized silicon n-channel RF power transistor designed for broadband commercial and military applications requiring high power and gain without compromising reliability, ruggedness, or inter-modulation distortion.



FEATURES

- Improved Ruggedness $V_{(BR)DSS} = 170V$
- Designed for 2-100MHz Operation
- 600W with 21dB Typical Gain @ 30MHz, 50V
- Excellent Stability & Low IMD
- Common Source Configuration
- Available in Matched Pairs
- 70:1 Load VSWR Capability at Specified Operating Conditions
- Nitride Passivated
- Economical Flangeless Package
- Refractory Gold Metallization
- High Voltage Replacement for MRF157
- RoHS Compliant 

Maximum Ratings

All Ratings: $T_c = 25^\circ C$ unless otherwise specified

Symbol	Parameter	VRF157FL(MP)	Unit
V_{DSS}	Drain-Source Voltage	170	V
I_D	Continuous Drain Current @ $T_c = 25^\circ C$	60	A
V_{GS}	Gate-Source Voltage	± 40	V
P_D	Total Device dissipation @ $T_c = 25^\circ C$	1350	W
T_{STG}	Storage Temperature Range	-65 to 150	$^\circ C$
T_J	Operating Junction Temperature Max	200	

Static Electrical Characteristics

Symbol	Parameter	Min	Typ	Max	Unit
$V_{(BR)DSS}$	Drain-Source Breakdown Voltage ($V_{GS} = 0V, I_D = 100mA$)	170	180		V
$V_{DS(ON)}$	On State Drain Voltage ($I_{D(ON)} = 40A, V_{GS} = 10V$)		3.7	5.7	
I_{DSS}	Zero Gate Voltage Drain Current ($V_{DS} = 100V, V_{GS} = 0V$)			4.0	mA
I_{GSS}	Gate-Source Leakage Current ($V_{DS} = \pm 20V, V_{GS} = 0V$)			4.0	μA
g_{fs}	Forward Transconductance ($V_{DS} = 10V, I_D = 20A$)	16			mhos
$V_{GS(TH)}$	Gate Threshold Voltage ($V_{DS} = 10V, I_D = 100mA$)	2.9	3.6	4.4	V

Thermal Characteristics

Symbol	Characteristic	Min	Typ	Max	Unit
$R_{\theta JC}$	Junction to Case Thermal Resistance			0.13	$^\circ C/W$
$R_{\theta JHS}$	Junction to Sink Thermal Resistance (Use High Efficiency Thermal Joint Compound and Planar Heat Sink Surface.)		0.22		

 **CAUTION:** These Devices are Sensitive to Electrostatic Discharge. Proper Handling Procedures Should Be Followed.

Dynamic Characteristics

VRF157FL(MP)

Symbol	Parameter	Test Conditions	Min	Typ	Max	Unit
C_{ISS}	Input Capacitance	$V_{GS} = 0V$		1580		pF
C_{OSS}	Output Capacitance	$V_{DS} = 50V$		810		
C_{RSS}	Reverse Transfer Capacitance	$f = 1MHz$		65		

Functional Characteristics

Symbol	Parameter	Min	Typ	Max	Unit
G_{PS}	$f = 30MHz, V_{DD} = 50V, I_{DQ} = 800mA, P_{out} = 600W$	17	21		dB
η_D	$f = 30MHz, V_{DD} = 50V, I_{DQ} = 800mA, P_{out} = 600W_{PEP}$		45		%
$IMD_{(dB)}$	$f1 = 30MHz, f2 = 30.001MHz, V_{DD} = 50V, I_{DQ} = 800mA, P_{out} = 600W_{PEP}^1$		-25		dBc
ψ	$f = 30MHz, V_{DD} = 50V, I_{DQ} = 800mA, P_{out} = 600W_{CW}$ 70:1 VSWR - All Phase Angles, 0.2mSec X 20% Duty Factor	No Degradation in Output Power			

1. To MIL-STD-1311 Version A, test method 2204B, Two Tone, Reference Each Tone

Microsemi reserves the right to change, without notice, the specifications and information contained herein.

Typical Performance Curves

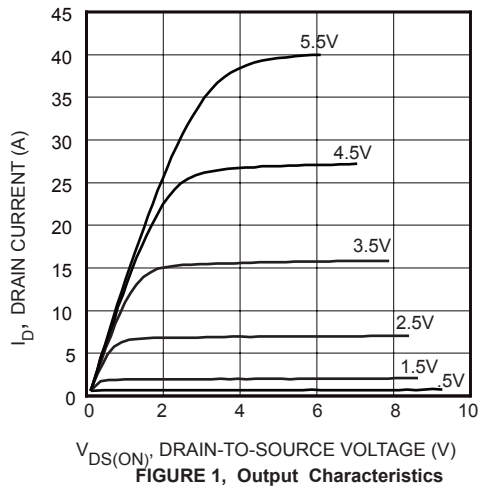

FIGURE 1, Output Characteristics

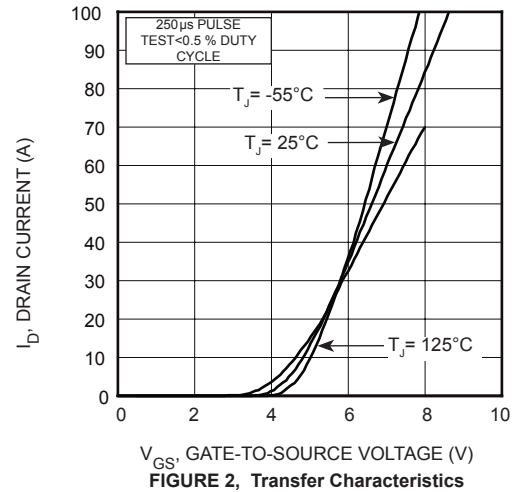

FIGURE 2, Transfer Characteristics

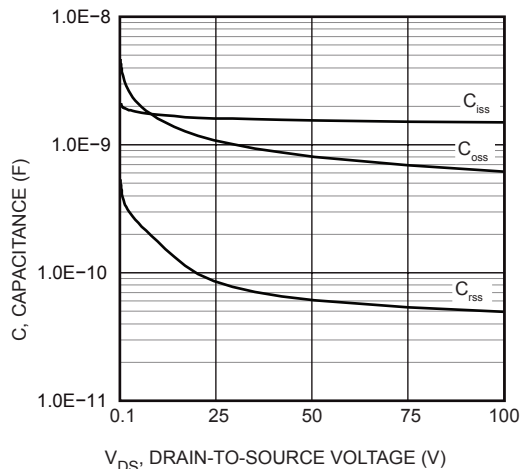

FIGURE 3, Capacitance vs Drain-to-Source Voltage

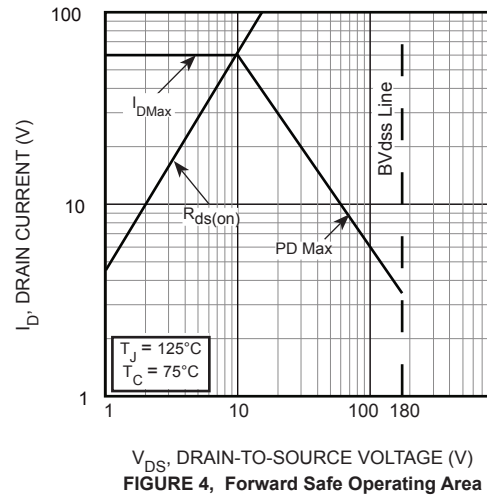

FIGURE 4, Forward Safe Operating Area

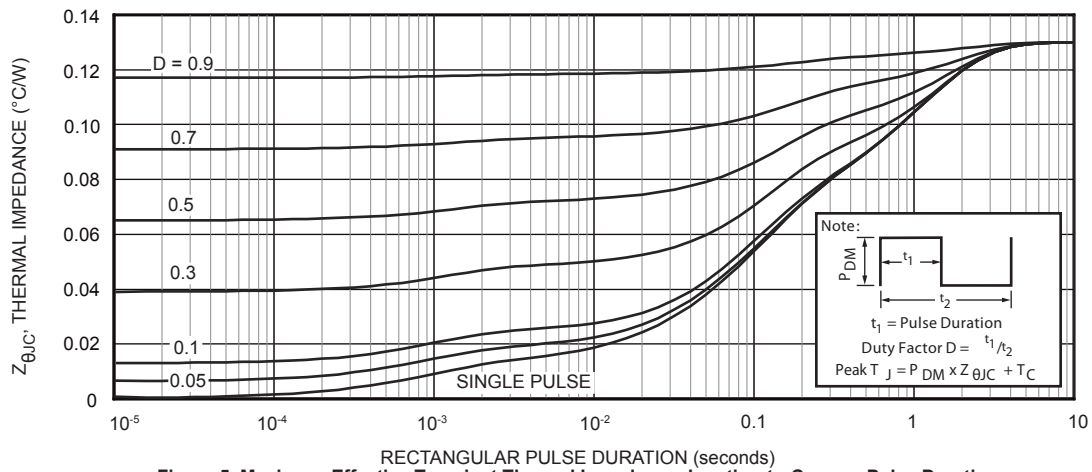

Figure 5. Maximum Effective Transient Thermal Impedance Junction-to-Case vs Pulse Duration

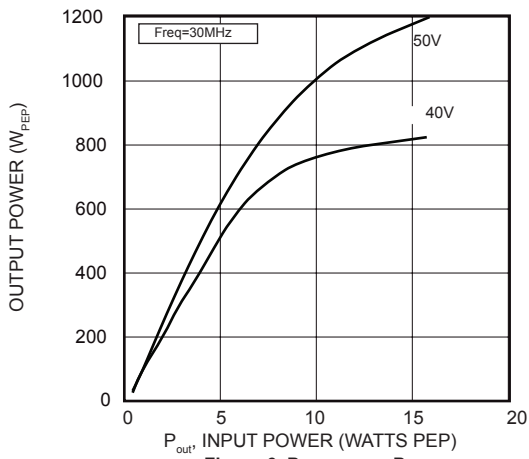

Figure 6. P_{OUT} versus P_{IN}

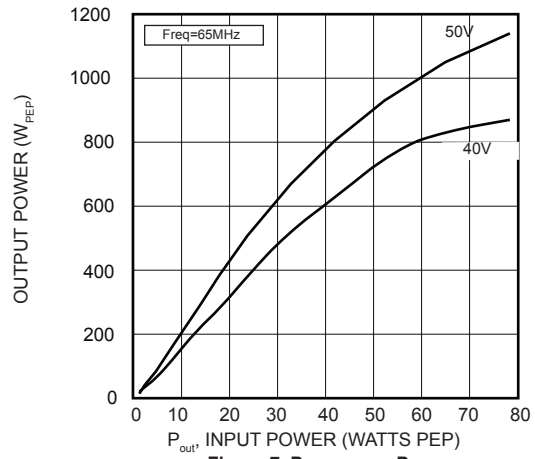

Figure 7. P_{OUT} versus P_{IN}

Figure 8. 30MHz Test Circuit

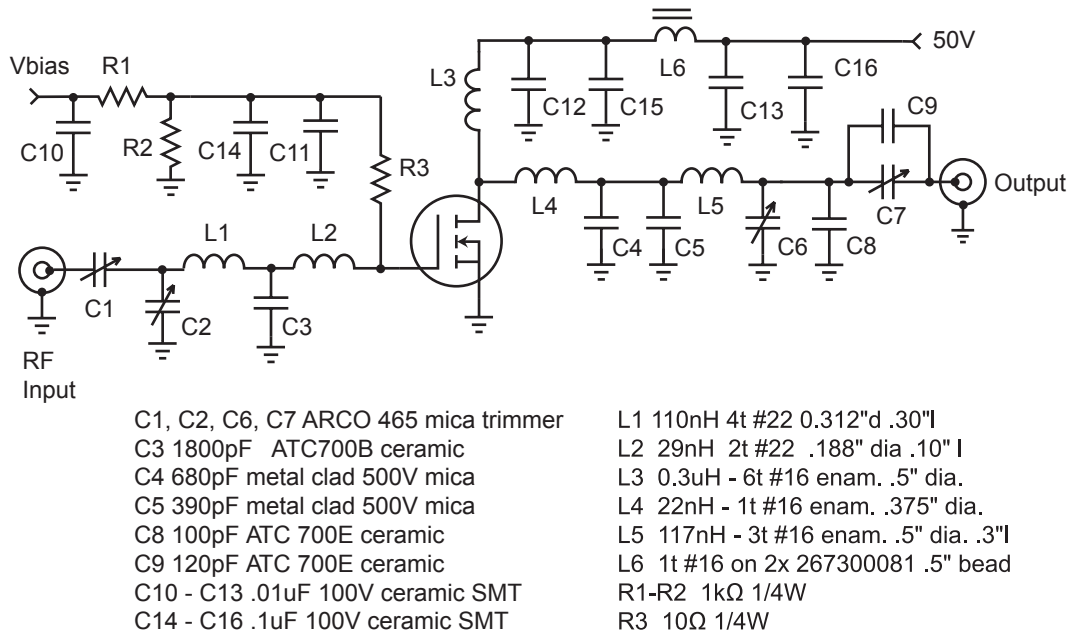
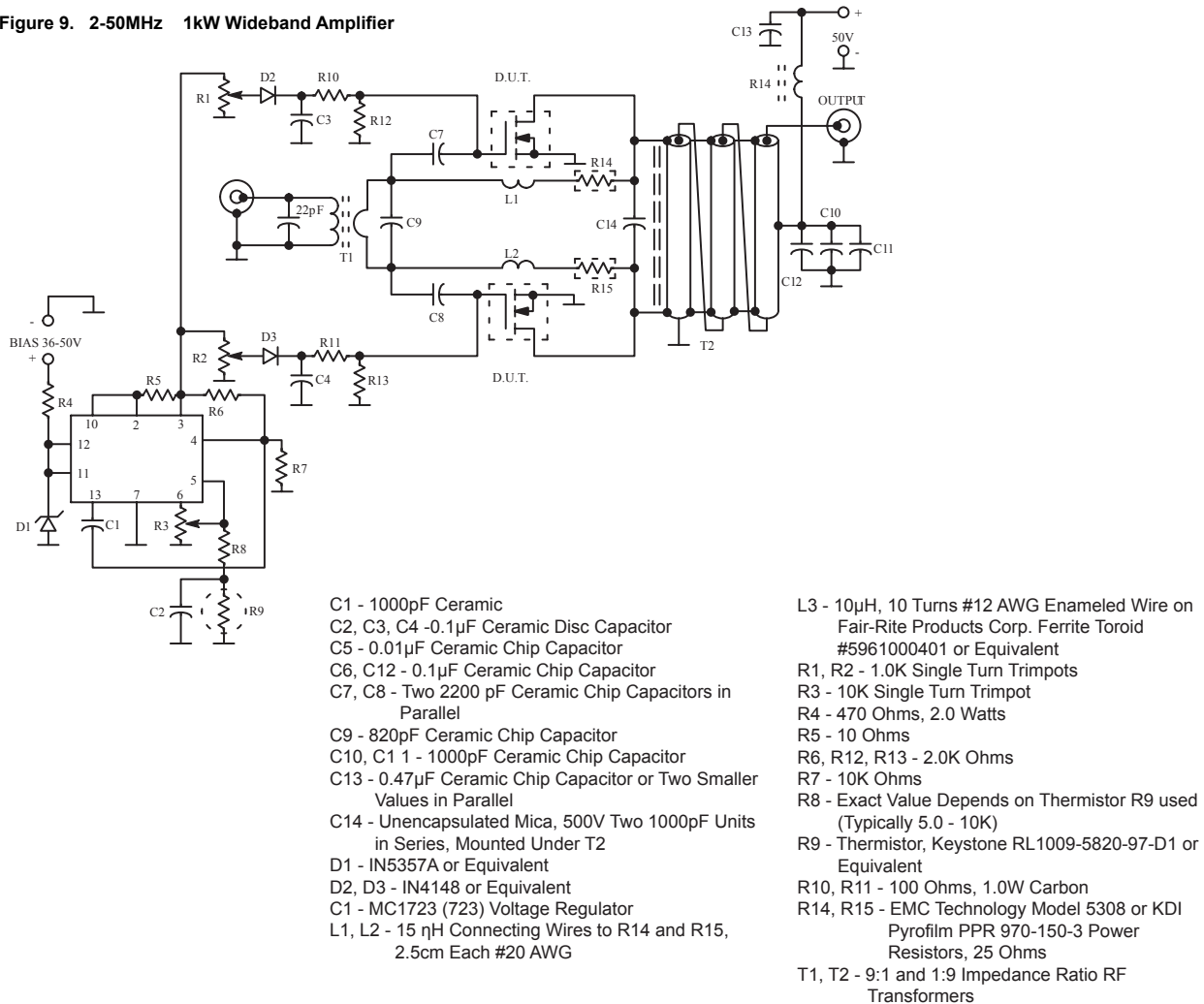

Figure 9. 2-50MHz 1kW Wideband Amplifier



Adding MP at the end of P/N specifies a matched pair where $V_{GS(TH)}$ is matched between the two parts. V_{TH} values are marked on the devices per the following table.

Code	Vth Range	Code 2	Vth Range
A	2.900 - 2.975	M	3.650 - 3.725
B	2.975 - 3.050	N	3.725 - 3.800
C	3.050 - 3.125	P	3.800 - 3.875
D	3.125 - 3.200	R	3.875 - 3.950
E	3.200 - 3.275	S	3.950 - 4.025
F	3.275 - 3.350	T	4.025 - 4.100
G	3.350 - 3.425	W	4.100 - 4.175
H	3.425 - 3.500	X	4.175 - 4.250
J	3.500 - 3.575	Y	4.250 - 4.325
K	3.575 - 3.650	Z	4.325 - 4.400

V_{TH} values are based on Microsemi measurements at datasheet conditions with an accuracy of 1.0%.

Thermal Considerations and Package Mounting:

The rated 1350W power dissipation is only available when the package mounting surface is at 25°C and the junction temperature is 200°C. The thermal resistance between junctions and case mounting surface is 0.13°C/W. When installed, an additional thermal impedance of 0.09°C/W between the package base and the mounting surface is smooth and flat. Thermal joint compound must be used to reduce the effects of small surface irregularities. The heatsink should incorporate a copper heat spreader to obtain best results.

The lid maintains the required mounting pressure while allowing for thermal expansion of both the device and the heat sink. Four 4-40 (M3) screws provide the minimum 125 lb. required mounting force. T=4-6 in-lb. Please refer to App Note 1810 "Mounting Instructions for Flangeless Packages."

HAZARDOUS MATERIAL WARNING

The ceramic portion of the device between leads and mounting flange is beryllium oxide. Beryllium oxide dust is highly toxic when inhaled. Care must be taken during handling and mounting to avoid damage to this area. These devices must never be thrown away with general industrial or domestic waste. BeO substrate weight: 1.934g. Percentage of total module weight which is BeO: 20%.

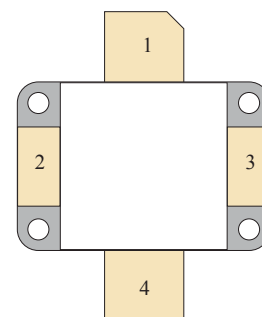
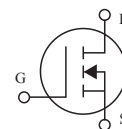
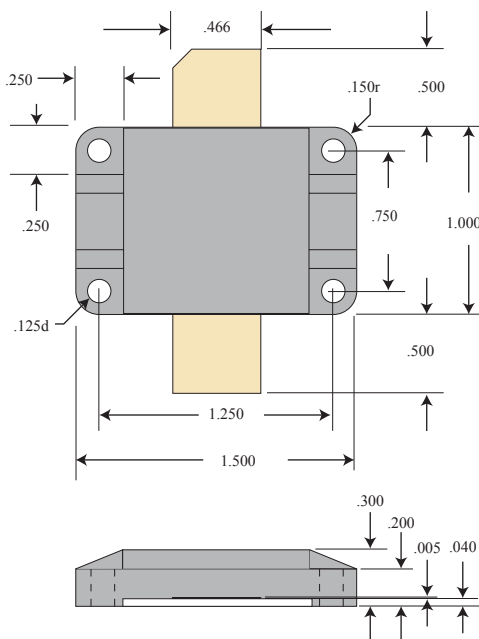

PIN 1 - DRAIN
 PIN 2 - SOURCE
 PIN 3 - SOURCE
 PIN 4 - GATE