

VTB Pick-to-Light Optical Touch Button



Instruction Manual

Ergonomic optical touch button for pick-to-light applications



- Microcontroller-based photoelectric touch buttons
- A cost-effective and easy-to-install alternative to capacitive touch switches and mechanical push buttons for error proofing and parts-verification applications
- Ergonomically designed to eliminate hand, wrist, and arm stresses associated with repeated switch operation; requires no physical pressure to operate
- Illuminated base provides a bright, easy-to-see job light in one or two colors, depending on model
- LED power and output indicators
- NPN or PNP output, depending on model
- Immune to ambient light, EMI and RFI interference
- High excess gain cuts through heavy airborne contamination to function in almost any environment
- Pre-installed field covers protect the device and prevent inadvertent activation



WARNING:

- **Do not use this device for personnel protection**
- Using this device for personnel protection could result in serious injury or death.
- This device does not include the self-checking redundant circuitry necessary to allow its use in personnel safety applications. A device failure or malfunction can cause either an energized (on) or de-energized (off) output condition.

Models

One-Color Job Light Models						
Job Light Color			Cable ¹	Upper Housing	Output Type	Job Light Input
Green	Red	Blue				
VTBN6	VTBN6R	VTBN6B	2 m 4-wire cable	Polysulfone	NPN	0 V DC
VTBN6Q	VTBN6RQ	VTBN6BQ	4-pin Euro QD			
VTBN6L	VTBN6RL	VTBN6BL	2 m 4-wire cable	Polycarbonate		
VTBN6LQ	VTBN6RLQ	VTBN6BLQ	4-pin Euro QD			
VTBP6	VTBP6R	VTBP6B	2 m 4-wire cable	Polysulfone	PNP	+4 V DC to 30 V DC
VTBP6Q	VTBP6RQ	VTBP6BQ	4-pin Euro QD			
VTBP6L	VTBP6RL	VTBP6BL	2 m 4-wire cable	Polycarbonate		
VTBP6LQ	VTBP6RLQ	VTBP6BLQ	4-pin Euro QD			

Two-Color Job Light Models				
Green and Red (see Wiring)	Cable ¹	Upper Housing	Output Type	Job Light Input
VTBN6GR	2 m 5-wire cable	Polysulfone	NPN	0 V DC
VTBN6GRQ	5-pin Euro QD			
VTBN6GRL	2 m 5-wire cable	Polycarbonate		
VTBN6GRLQ	5-pin Euro QD			
VTBP6GR	2 m 5-wire cable	Polysulfone	PNP	+4 V DC to 30V DC
VTBP6GRQ	5-pin Euro QD			
VTBP6GRL	2 m 5-wire cable	Polycarbonate		
VTBP6GRLQ	5-pin Euro QD			

¹ To order the 9 m (30 ft) cable models, add the suffix "W/30" to the cabled model number. (For example, VTBN6 W/30.) Models with a quick disconnect connector require a mating cable. (See [Quick Disconnect \(QD\) Cables](#) on p. 4).



Overview

Banner VTB Series touch buttons are ergonomically designed to eliminate the hand, wrist, and arm stresses associated with mechanical push buttons. They require no physical pressure to operate. LED indicators light when power is on and outputs are activated.

The solid-state output interfaces to a system controller, which is pre-programmed for a specific sequence of tasks. Mounted in or near each bin in an assembler's work station, the sensor job light signals the assembler which bins contain items to be picked in a given operation and in what order they should be picked.

As the assembler takes a part in sequence, then reaches a finger into the yoke of the corresponding touch button, the sensor senses that the part was removed and it sends an output signal to the controller. The controller then verifies if the correct part was taken and may respond by turning that job light OFF, activating the job light of the next bin in the sequence.

If multiple parts are to be removed from one bin, the job light may remain ON until the appropriate number of signals is returned to the controller. If an incorrect part is selected, the control system may be wired to signal an alarm for the assembler and/or a supervisor, or it may be programmed to interpret the action as a call for parts.

All models are immune to EMI, RFI, and ambient light interference. VTBs have either a black polysulfone or red polycarbonate upper housing (depending on model) and a translucent white polycarbonate base. Environmental considerations for use of the two upper housing types differ; see specifications. The entire base section lights to provide a bright job light where a task is to be performed. The 30 mm threaded base on all models provides easy mounting.

Rugged translucent polypropylene (TP) field covers are installed on all models to prevent inadvertent switch actuation due to objects (such as loose clothing or debris) which might accidentally block the sensing beam. The polypropylene material is capable of absorbing high impact (even at low temperatures) and is highly resistant to abrasion and to damage by most chemicals.

EU Declaration of Conformity (DoC)

Banner Engineering Corp. herewith declares that these products are in conformity with the provisions of the listed directives and all essential health and safety requirements have been met. For the complete DoC, please go to www.bannerengineering.com.

Product	Directive
VTB Optical Touch Buttons DC Models	EMC Directive 2014/30/EU

Representative in EU: Peter Mertens, Managing Director, Banner Engineering BV. Address: Park Lane, Culliganlaan 2F, bus 3,1831 Diegem, Belgium.

Indicators

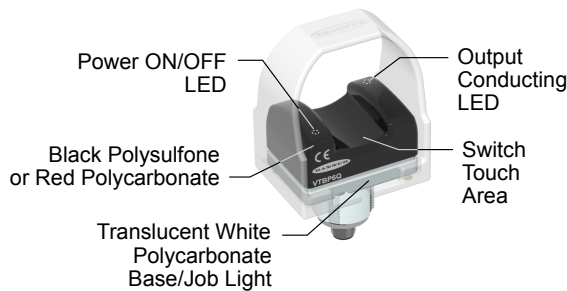

Power ON/OFF (red):

Steady ON when power is applied

Output Conducting (red):

Steady ON when button is activated

OFF when button is not activated

Job Light:

Steady ON or flashing ² when a task is to be performed

Installation

Mount the Device Using the Threaded Base

1. If your device came with a lock washer or gasket, place it on the threaded base.
2. Insert the base of the device through a hole or a bracket.
 - If desired and available, insert the device through an appropriately sized hole in the machine or equipment at the desired location.
 - If a bracket is needed, insert the device into the bracket.
3. Thread the mounting nut onto the base of the device, finger tight.
4. If using a bracket, mount the device and the bracket to the machine or equipment at the desired location. Do not tighten the mounting screws at this time.
5. Check the device alignment, if precise alignment is necessary.

² Flashing job light is dependent on wiring. Color is dependent on model and wiring.

6. Tighten the nut.
7. If using a bracket, tighten the mounting screws to secure the device and the bracket in the aligned position.

Wiring

Single-color models may be wired for either a solid or flashing job light. The wiring of two-color models determines the job light. Color flashing job light is not available. Cabled model wiring shown. Cabled and QD model wiring is functionally identical.

- For solid color, use the standard wiring diagram.
- For flashing (2 Hz), use the alternate wiring diagrams.

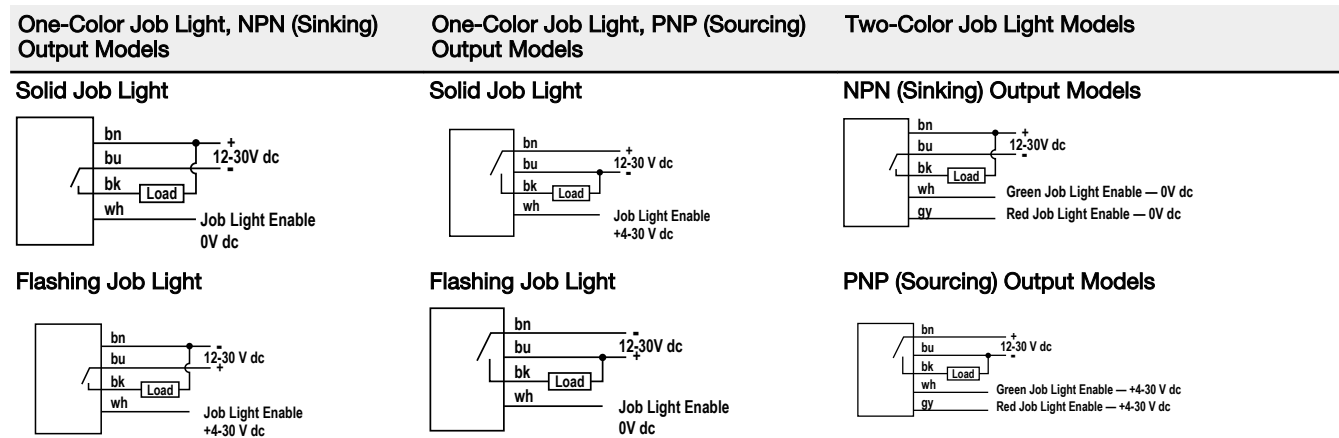

Specifications

Supply Voltage and Current

One-color job light models: Less than 120 mA max current at 12 V DC and less than 70 mA max current at 30 V DC (exclusive of load)
 Two-color job light models: Less than 67 mA max current at 12 V DC; less than 40 mA max current at 24 V DC; and less than 35 mA max current at 30 V DC (exclusive of load)

Supply Protection Circuitry

Protected against reverse polarity and transient voltages (fast-transient and overvoltage)

Output Configuration

1 current sinking (NPN) open collector transistor or 1 current sourcing (PNP) open collector transistor, depending on model

Output Rating

Max. load: 150 mA
 On-state saturation voltage: < 1.5 V at 150 mA
 Off-state leakage current: < 10 μ A

Output Protection Circuitry

All models protected against false pulse on power-up (outputs held OFF for 1 second at power-up), overload and short-circuits.

Output Response Time

100 milliseconds ON/OFF

Indicators

2 green LED indicators: Power ON and Output Conducting
 Base lights green, red or blue (depending on model and wiring) as a job light when input line is enabled. One-color models may be wired for flashing, rather than solid color operation.

Connections

PVC-jacketed 2 m (6.5 ft) cables or 4-pin M12/Euro-style QD fitting, depending on model; integral 9 m (30 ft) cables are also available. Accessory QD cables required for QD models.

Ambient Light Immunity

Up to 120,000 lux (direct sunlight)

EMI/RFI Immunity

Immune to EMI and RFI noise sources, per IEC 947-5-2

Construction

Totally encapsulated, non-metallic enclosure. Black polysulfone or red polycarbonate upper housing (see Application Note below); translucent white polycarbonate base. Electronics fully epoxy-encapsulated.

Protective cover: Polypropylene copolymer

Operating Conditions

-20 °C to +50 °C (-4 °F to +122 °F)
 90% at +50 °C maximum relative humidity (non-condensing)

Environmental Rating

Meets NEMA standards 1, 3, 4, 4X, 12, and 13; IEC IP66

Application Notes

Environmental considerations for models with polysulfone upper housings: The polysulfone upper housing will become brittle with prolonged exposure to outdoor sunlight. Window glass effectively filters longer wavelength ultraviolet light and provides excellent protection from sunlight. Avoid contact with strong alkalis. Clean periodically using mild soap solution and a soft cloth.
 Environmental considerations for models with polycarbonate upper housings: Avoid prolonged exposure to hot water and moist high temperature environments above 66° C (150° F). Avoid contact with aromatic hydrocarbons (such as xylene and toluene), halogenated hydrocarbons and strong alkalis. Clean periodically using mild soap solution and a soft cloth.

Certifications



Required Overcurrent Protection



WARNING: Electrical connections must be made by qualified personnel in accordance with local and national electrical codes and regulations.

Overcurrent protection is required to be provided by end product application per the supplied table. Overcurrent protection may be provided with external fusing or via Current Limiting, Class 2 Power Supply. Supply wiring leads < 24 AWG shall not be spliced. For additional product support, go to www.bannerengineering.com.

Supply Wiring (AWG)	Required Overcurrent Protection (Amps)
20	5.0
22	3.0
24	2.0
26	1.0
28	0.8
30	0.5

Dimensions

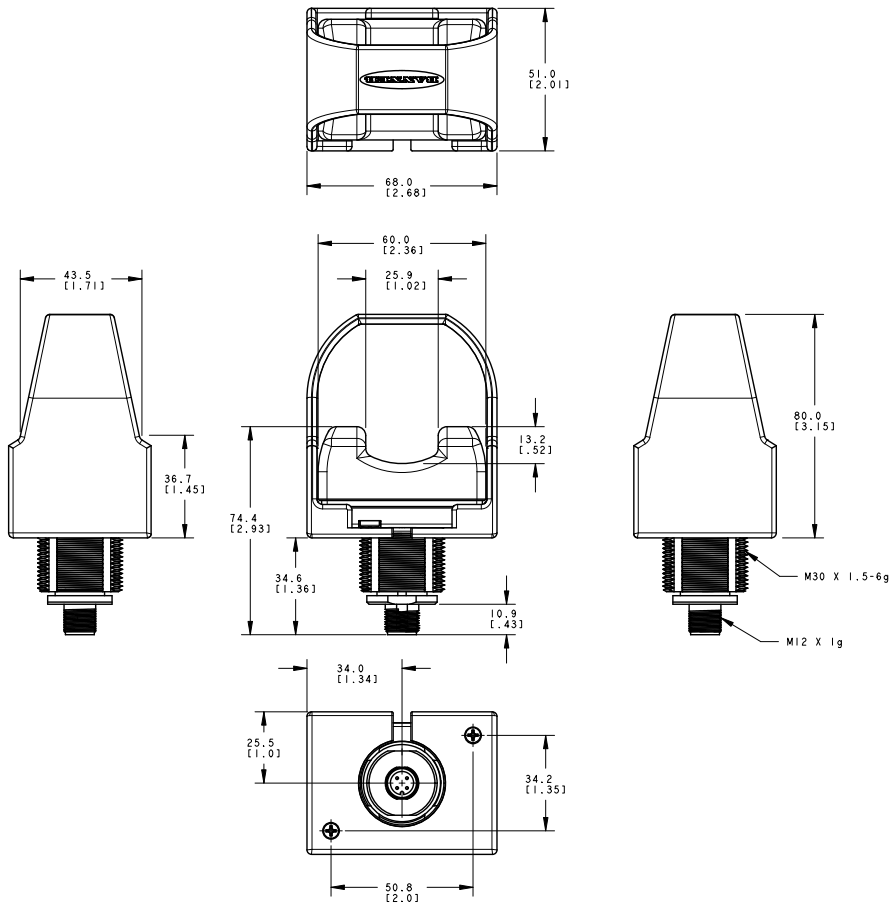

Accessories

Quick Disconnect (QD) Cables

Use the 4-pin Euro-style cordsets with the one-color job light models.

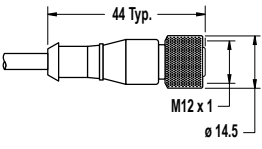
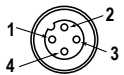
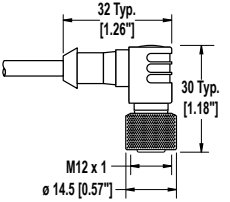
4-Pin Threaded M12/Euro-Style Cordsets—Single Ended				
Model	Length	Style	Dimensions	Pinout (Female)
MQDC-406	2 m (6.56 ft)	Straight		 1 = Brown 2 = White 3 = Blue 4 = Black
MQDC-415	5 m (16.4 ft)			
MQDC-430	9 m (29.5 ft)			
MQDC-450	15 m (49.2 ft)			
MQDC-406RA	2 m (6.56 ft)	Right-Angle		
MQDC-415RA	5 m (16.4 ft)			
MQDC-430RA	9 m (29.5 ft)			
MQDC-450RA	15 m (49.2 ft)			

Use the 5-pin Euro-style cordsets with the two-color job light models.

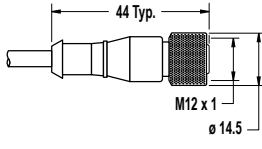
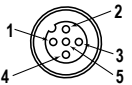
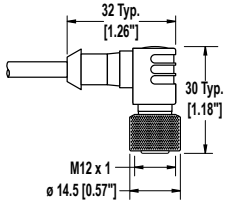
5-Pin Threaded M12/Euro-Style Cordsets—Single Ended				
Model	Length	Style	Dimensions	Pinout (Female)
MQDC1-501.5	0.5 m (1.5 ft)	Straight		 1 = Brown 2 = White 3 = Blue 4 = Black 5 = Gray
MQDC1-506	2 m (6.5 ft)			
MQDC1-515	5 m (16.4 ft)			
MQDC1-530	9 m (29.5 ft)			
MQDC1-506RA	2 m (6.5 ft)	Right-Angle		
MQDC1-515RA	5 m (16.4 ft)			
MQDC1-530RA	9 m (29.5 ft)			

Mounting Brackets

All measurements are in mm

SMB30A

- Right-angle bracket with curved slot for versatile orientation
- Clearance for M6 (¼ in) hardware
- Mounting hole for 30 mm sensor
- 12-ga. stainless steel

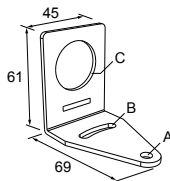

Hole center spacing: A to B=40

Hole size: A=ø 6.3, B= 27.1 x 6.3, C=ø 30.5

SMB30SC

- Swivel bracket with 30 mm mounting hole for sensor
- Black reinforced thermoplastic polyester
- Stainless steel mounting and swivel locking hardware included

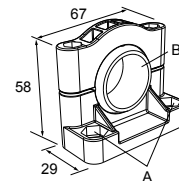

Hole center spacing: A=ø 50.8

Hole size: A=ø 7.0, B=ø 30.0