

1.575 GHz GPS Ceramic Chip Antenna

On Ground type, ie. solid ground plane under antenna, top surface ground removal 10.80 x 6.25 mm.

Pulse Part Number: W3009

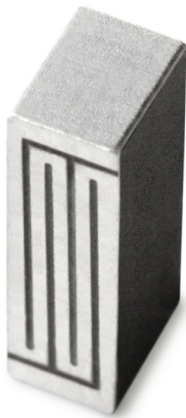

Features

- Omnidirectional radiation
- Low profile
- Compact size W x L x H (10 x 3.2 x 4 mm)
- Low weight (600 mg)
- Lead free materials
- Fully SMD compatible
- Lead free soldering compatible
- Tape and reel packing
- RoHS Compliant Product

Applications

- GPS L1 band
- 1.575 GHz

Electrical specifications @ +25 °C

Note: Electrical characteristics depend on test board (GP) size and antenna positioning on GP.

GPS

Typical performance (test board size 80 x 37 mm, PWB top surface ground removal area 10.80 x 6.25 mm)

| Frequency Range [MHz] | RHCP Gain [dBic] | Linear Max Gain [dBi] | Efficiency [%] / [dB] | Return loss min. [dB] | Impedance [Ω] | Operating Temperature [°C] |
|-----------------------|--------------------------------|------------------------------|---|-----------------------|------------------------|----------------------------|
| 1575.42 +/-10 | 0.7 (Peak) 0.3 (Band edges) | 3 (Peak) 2.5 (Band edges) | 80 / -1 (Peak) 75 / -1.25 (Band edges) | -10 | 50 | -40 to +85 |

Pulse Finland Oy

Takatie 6
90440 Kempele, Finland
Tel: +358 207 935 500
Fax: +358 207 935 501

www.pulseeng.com/antennas



1.575 GHz GPS Ceramic Chip Antenna

On Ground type, ie. solid ground plane under antenna, top surface ground removal 10.80 x 6.25 mm.

Pulse Part Number: W3009

Terminal Configuration

Layout

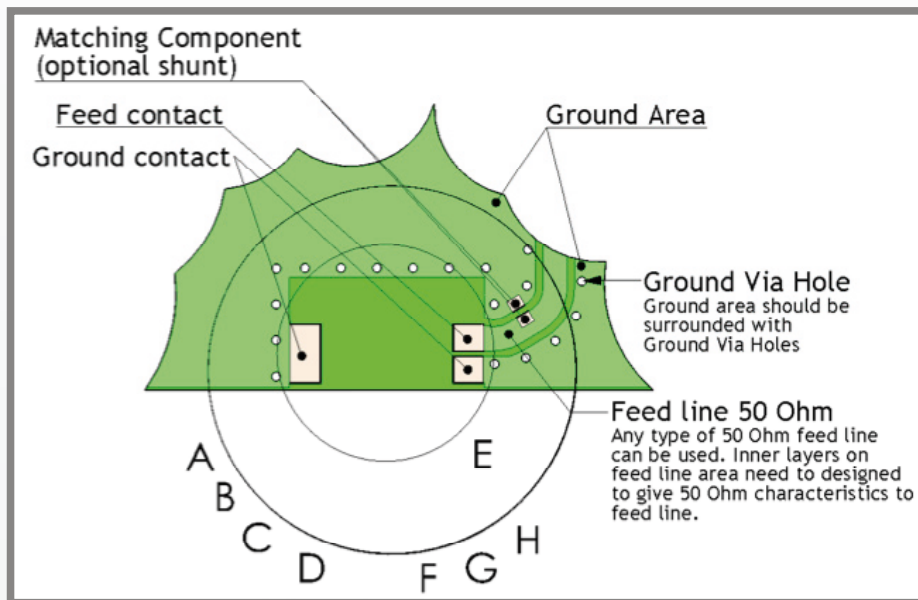

Pad dimensions in top copper

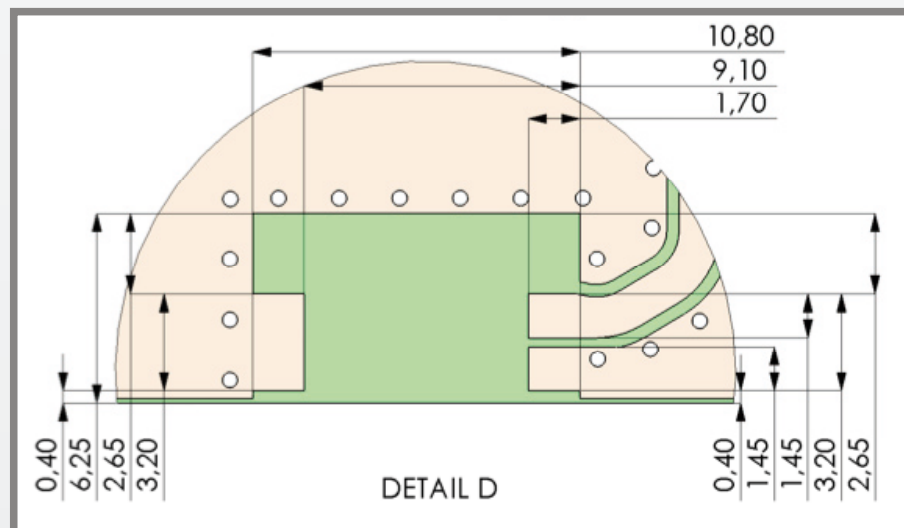

1.575 GHz GPS Ceramic Chip Antenna

On Ground type, ie. solid ground plane under antenna, top surface ground removal 10.80 x 6.25 mm.

Pulse Part Number: W3009

Terminal Configuration

Antenna

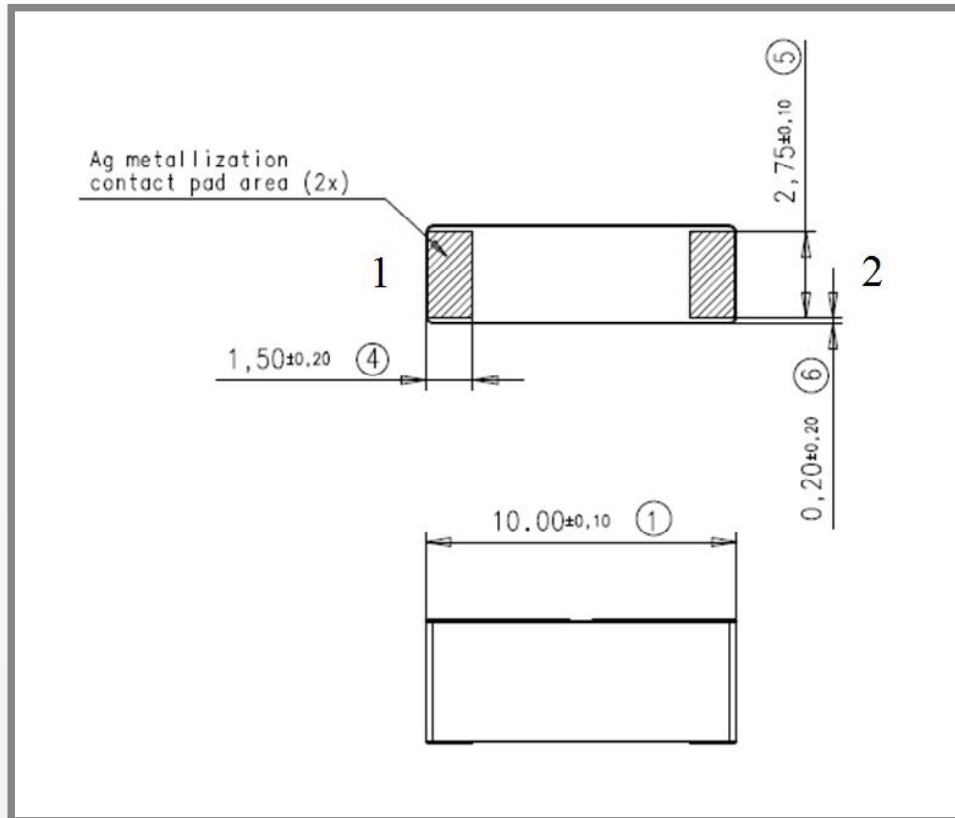

| No. | Terminal Name | Terminal Dimensions |
|-----|---------------|---------------------|
| 1 | Feed / GND | 1.50 x 2.75 mm |
| 2 | Feed / GND | 1.50 x 2.75 mm |

Antenna is symmetrical. Either of terminals 1 or 2 can be Feed / GND

Pulse Finland Oy

Takatie 6

90440 Kempele, Finland

Tel: +358 207 935 500

Fax: +358 207 935 501

www.pulseeng.com/antennas



1.575 GHz GPS Ceramic Chip Antenna

On Ground type, ie. solid ground plane under antenna, top surface ground removal 10.80 x 6.25 mm.

Pulse Part Number: W3009

Typical Electrical Characteristics (T=25 °C)

Measured on the 80 x 37 mm test board with matching circuit (2.2 pF shunt matching capacitor on feed).

Typical Return Loss S11/ impedance, free space efficiency and gain

GPS Ceramic Chip Antenna

25 May 2007 07:22:17

CH1Markers

- 1. -12.032 dB 1.56500 GHz
- 2. -20.839 dB 1.575.420 MHz
- 3. -11.637 dB 1.58500 GHz

CH1 S11 LOG

5 dB/REF 0 dB

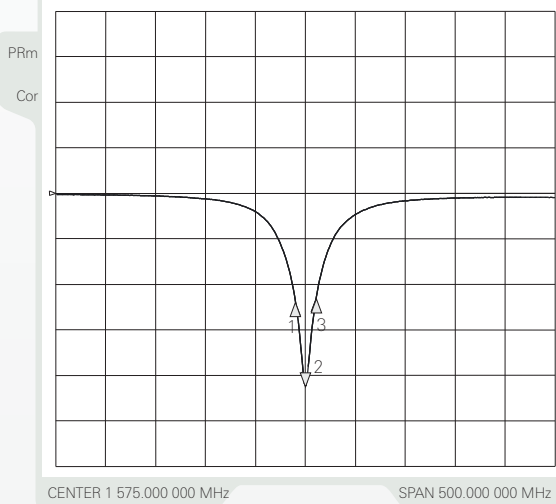

GPS Ceramic Chip Antenna

25 May 2007 07:23:38

- 1. 64.203 Ω 25.500 Ω 1.56500 GHz
- 2. 56.211 Ω -8.5977 Ω 11.750 pF
1.575.420 000 MHz
- 3. 33.688 Ω -17.396 Ω 1.58500 GHz

CH1 S11 1 U FS

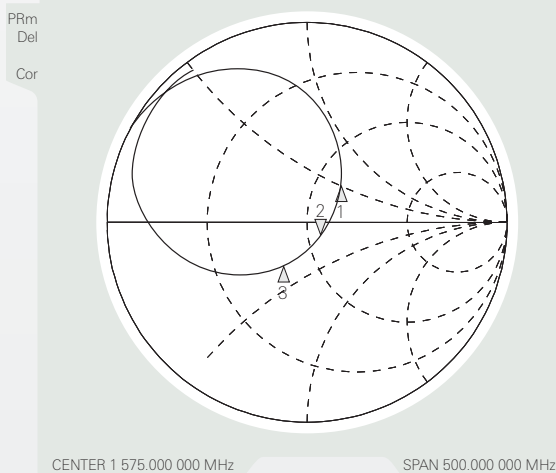

GPS OG 10 x 3.2 x 4 mm

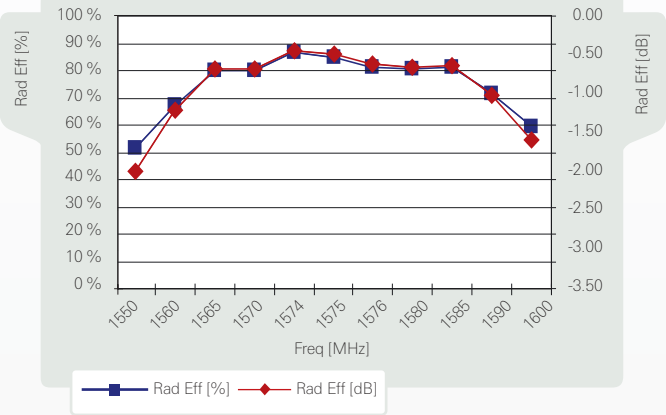

GPS OG 10 x 3.2 x 4 mm

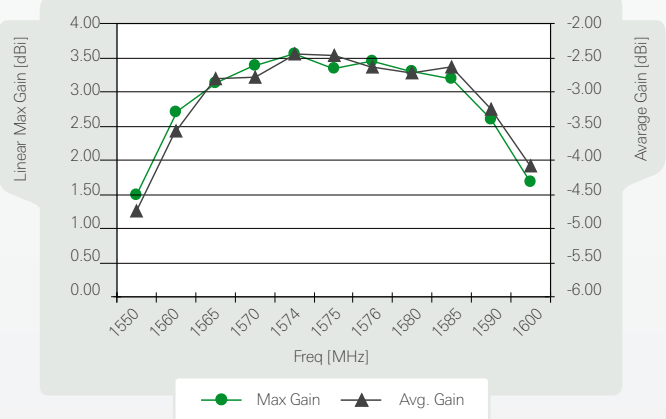

GPS OG 10 x 3.2 x 4 mm

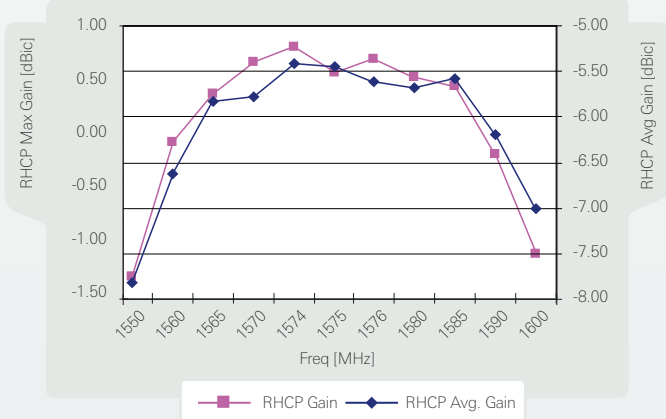

1.575 GHz GPS Ceramic Chip Antenna

On Ground type, ie. solid ground plane under antenna, top surface ground removal 10.80 x 6.25 mm.

Pulse Part Number: W3009

Typical Free Space Radiation Patterns

