

**Description: ISM433MHz Embedded Antenna**

**Series: Ceramic Antenna**

**PART NUMBER: W3015L**

**Features:**

- SMT Chip Antenna
- 433MHz
- 10x3.2x4mm
- MSL-1

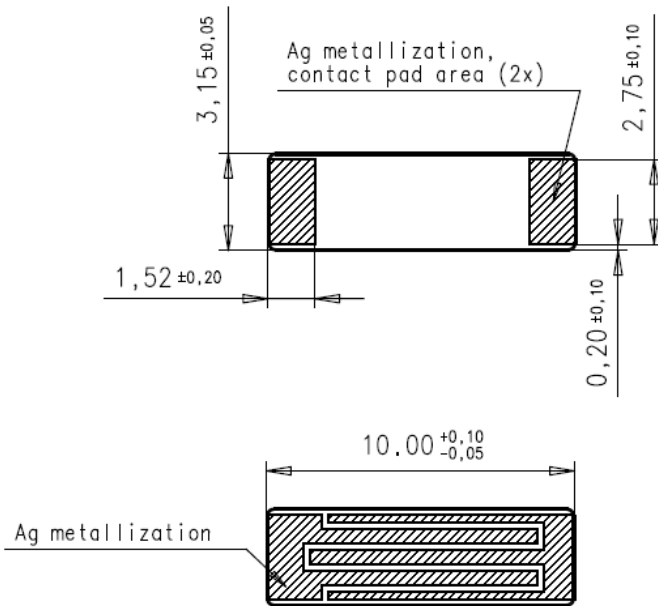
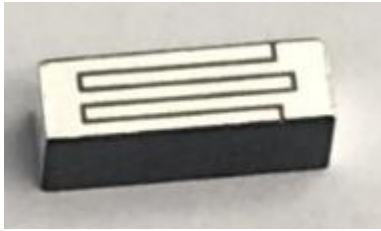

**Applications:**

- ISM radios for 433MHz
- Remote controls
- IoT, M2M

All dimensions are in mm / inches

Issue: 2035

In the effort to improve our products, we reserve the right to make changes judged to be necessary.

CONFIDENTIAL AND PROPRIETARY INFORMATION

This document contains confidential and proprietary information of Pulse Electronics, Inc. (Pulse) and is protected by copyright, trade secret and other state and federal laws. Its receipt or possession does not convey any rights to reproduce, disclose its contents, or to manufacture, use or sell anything it may describe. Reproduction, disclosure or use without specific written authorization of Pulse is strictly forbidden.

For more information:

Pulse Worldwide Headquarters  
12220 World Trade Drive  
San Diego, CA 92128  
USA  
Tel: 1-858-674-8100

Pulse/Larsen Antennas  
3611 NE 112<sup>th</sup> Ave  
Vancouver, WA 98682  
USA  
Tel: 1-360-944-7551

Europe Headquarters  
Pulse GmbH & Do, KG  
Zeppelinstrasse 15  
Herrenberg, Germany  
Tel: 49 7032 7806 0

Pulse (Suzhou) Wireless Products Co, Inc.  
99 Huo Ju Road(#29 Bldg,4<sup>th</sup> Phase  
Suzhou New District  
Jiangsu Province, Suzhou 215009 PR China  
Tel: 86 512 6807 9998



Description: ISM433MHz Embedded Antenna

Series: Ceramic Antenna

PART NUMBER: W3015L

**ELECTRICAL SPECIFICATIONS**

Frequency	433MHz
Nominal Impedance	50Ω
VSWR	<2
Gain	0dBi +/- 1 dB
Efficiency(%)	45%
Polarization	Linear
Power withstanding	3W

Issue: 2035

In the effort to improve our products, we reserve the right to make changes judged to be necessary.

CONFIDENTIAL AND PROPRIETARY INFORMATION

This document contains confidential and proprietary information of Pulse Electronics, Inc. (Pulse) and is protected by copyright, trade secret and other state and federal laws. Its receipt or possession does not convey any rights to reproduce, disclose its contents, or to manufacture, use or sell anything it may describe. Reproduction, disclosure or use without specific written authorization of Pulse is strictly forbidden.

Description: ISM433MHz Embedded Antenna

Series: Ceramic Antenna

PART NUMBER: W3015L

**MECHANICAL SPECIFICATIONS**

Weight	0.64g
Size (W x L x H)	10x3.2x4mm
MSL (Moisture Sensitivity Level)	1

**ENVIRONMENTAL SPECIFICATIONS**

Operating temperature	-40~+85° C
Storage temperature	-10~+30° C
Humidity	Cyclic 6 +25° C/+55° C 95%
Vibration	
Sinusoidal 2-8Hz	7.5 mm
Sinusoidal 8-200Hz	20 m/s <sup>2</sup>
Shocks	0.5 m/s
Salt mist	96 hours

Issue: 2035

In the effort to improve our products, we reserve the right to make changes judged to be necessary.

CONFIDENTIAL AND PROPRIETARY INFORMATION

This document contains confidential and proprietary information of Pulse Electronics, Inc. (Pulse) and is protected by copyright, trade secret and other state and federal laws. Its receipt or possession does not convey any rights to reproduce, disclose its contents, or to manufacture, use or sell anything it may describe. Reproduction, disclosure or use without specific written authorization of Pulse is strictly forbidden.



Description: ISM433MHz Embedded Antenna

Series: Ceramic Antenna

PART NUMBER: W3015L

MECHANICAL DRAWING

ISM 433 MHz Antenna

Ceramic Chip Antenna (ground cleared under antenna 10.80 mm x 14.00 mm)

Recommended test board for electrical characteristic measurement:

- Ground clearance area dimensions
- Soldering pad layout
- External matching component
  - o **33pF 0402 sized parallel shunt capacitor**, exact capacitor value depends on used board and feed line configuration

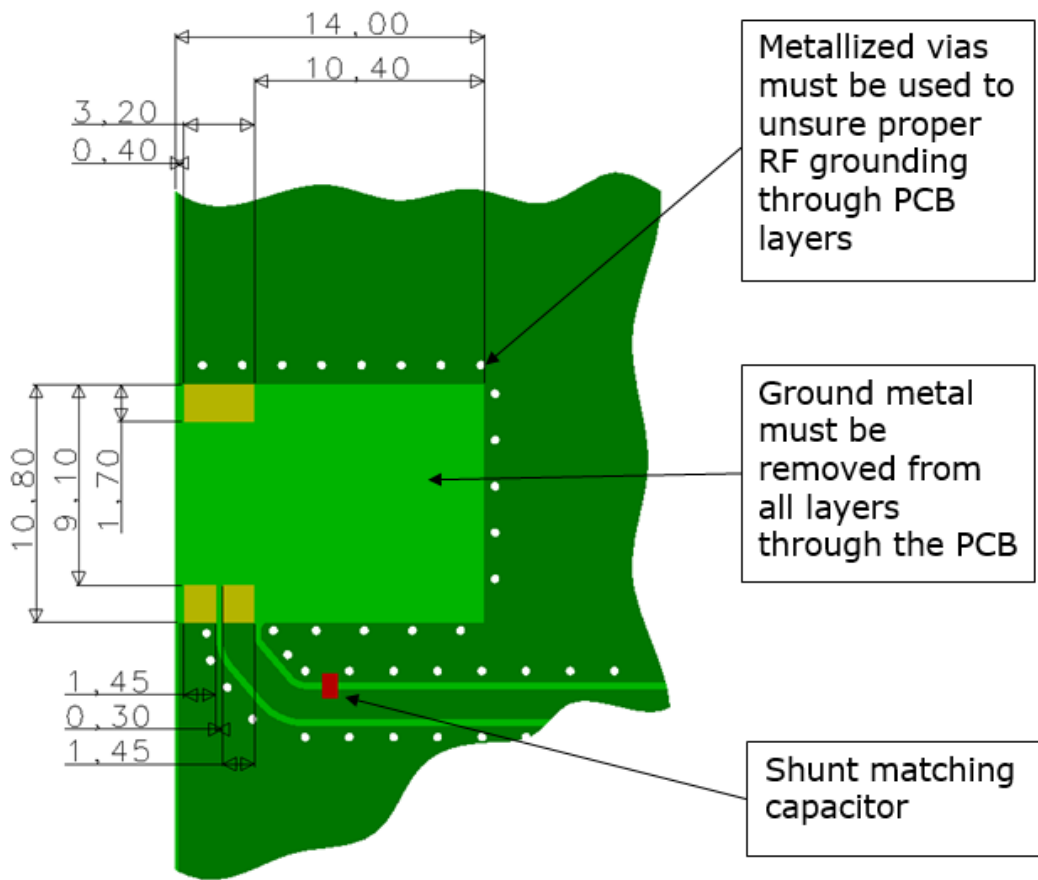

Issue: 2035

In the effort to improve our products, we reserve the right to make changes judged to be necessary.

CONFIDENTIAL AND PROPRIETARY INFORMATION

This document contains confidential and proprietary information of Pulse Electronics, Inc. (Pulse) and is protected by copyright, trade secret and other state and federal laws. Its receipt or possession does not convey any rights to reproduce, disclose its contents, or to manufacture, use or sell anything it may describe. Reproduction, disclosure or use without specific written authorization of Pulse is strictly forbidden.

Description: ISM433MHz Embedded Antenna

Series: Ceramic Antenna

PART NUMBER: W3015L

MECHANICAL DRAWING

# ISM 433 MHz Antenna

Ceramic Chip Antenna (ground cleared under antenna 10.80 mm x 14.00 mm)

## Recommended test board for electrical characteristic measurement:

### - Detailed soldering pad dimensions

- Note: Antenna chip has only two soldering terminals (see figure 1.) but in PCB the feed pad is separated from the adjacent ground pad due to impedance matching

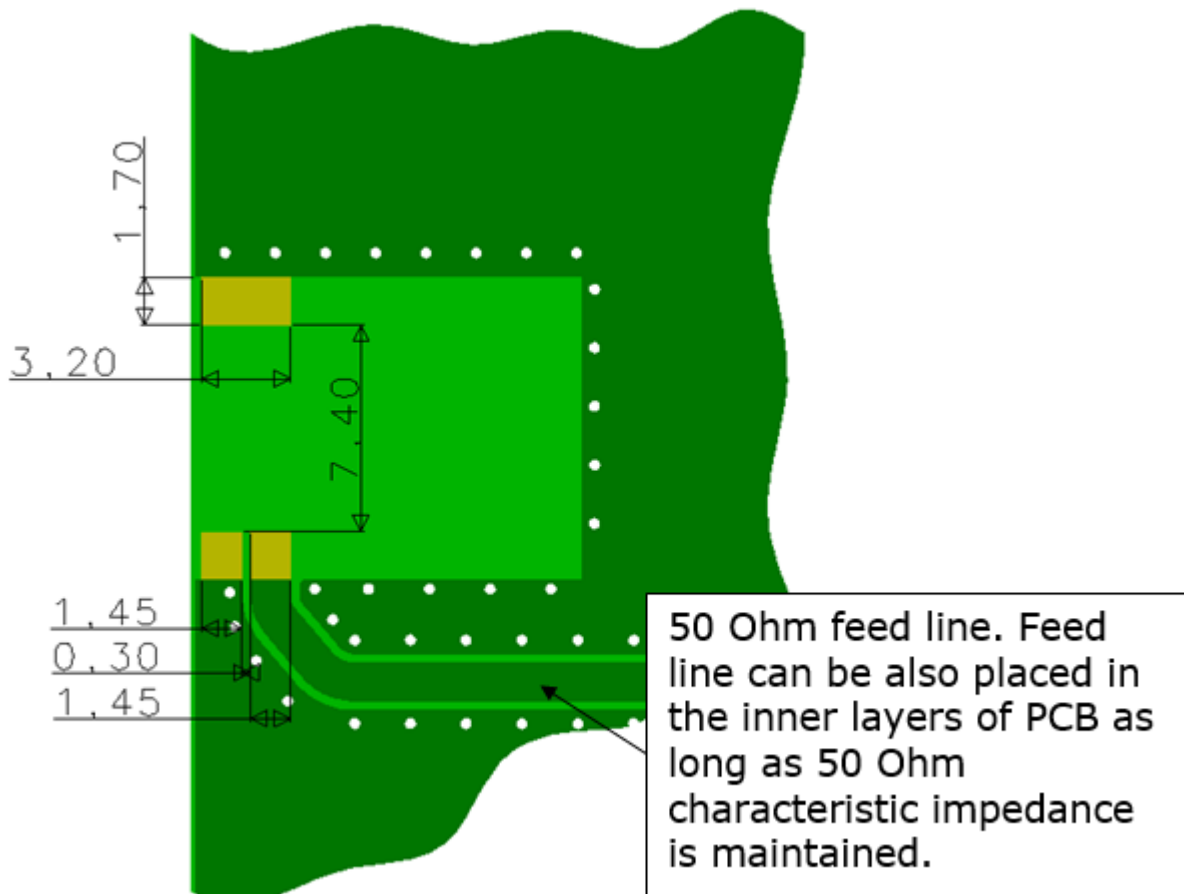

Issue: 2035

In the effort to improve our products, we reserve the right to make changes judged to be necessary.

CONFIDENTIAL AND PROPRIETARY INFORMATION

This document contains confidential and proprietary information of Pulse Electronics, Inc. (Pulse) and is protected by copyright, trade secret and other state and federal laws. Its receipt or possession does not convey any rights to reproduce, disclose its contents, or to manufacture, use or sell anything it may describe. Reproduction, disclosure or use without specific written authorization of Pulse is strictly forbidden.

Description: ISM433MHz Embedded Antenna

Series: Ceramic Antenna

PART NUMBER: W3015L

## MECHANICAL DRAWING

### ISM 433 MHz Antenna

Ceramic Chip Antenna (ground cleared under antenna 10.80 mm x 14.00 mm)

#### Recommended test board for electrical characteristic measurement:

- Evaluation board outline dimensions
  - o 200 x 100 mm or 200 x 37 mm (note difference in performance, see table 1.)
- Antenna placement on evaluation board
  - o In the centre of the board long (200 mm) edge

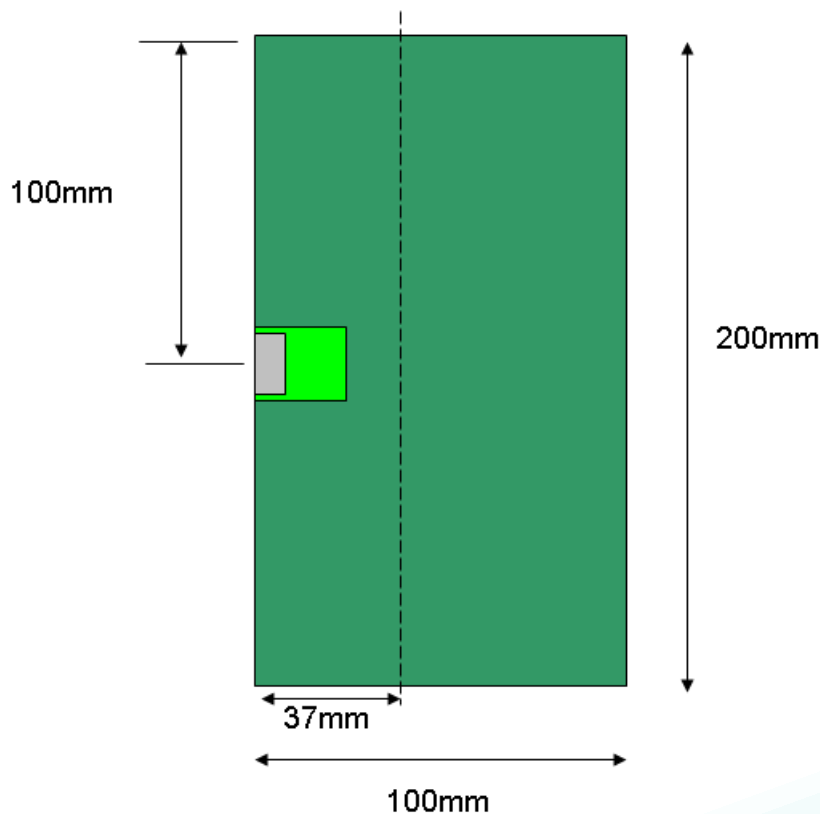

Issue: 2035

In the effort to improve our products, we reserve the right to make changes judged to be necessary.

CONFIDENTIAL AND PROPRIETARY INFORMATION

This document contains confidential and proprietary information of Pulse Electronics, Inc. (Pulse) and is protected by copyright, trade secret and other state and federal laws. Its receipt or possession does not convey any rights to reproduce, disclose its contents, or to manufacture, use or sell anything it may describe. Reproduction, disclosure or use without specific written authorization of Pulse is strictly forbidden.

Description: ISM433MHz Embedded Antenna

Series: Ceramic Antenna

PART NUMBER: W3015L

CHARTS

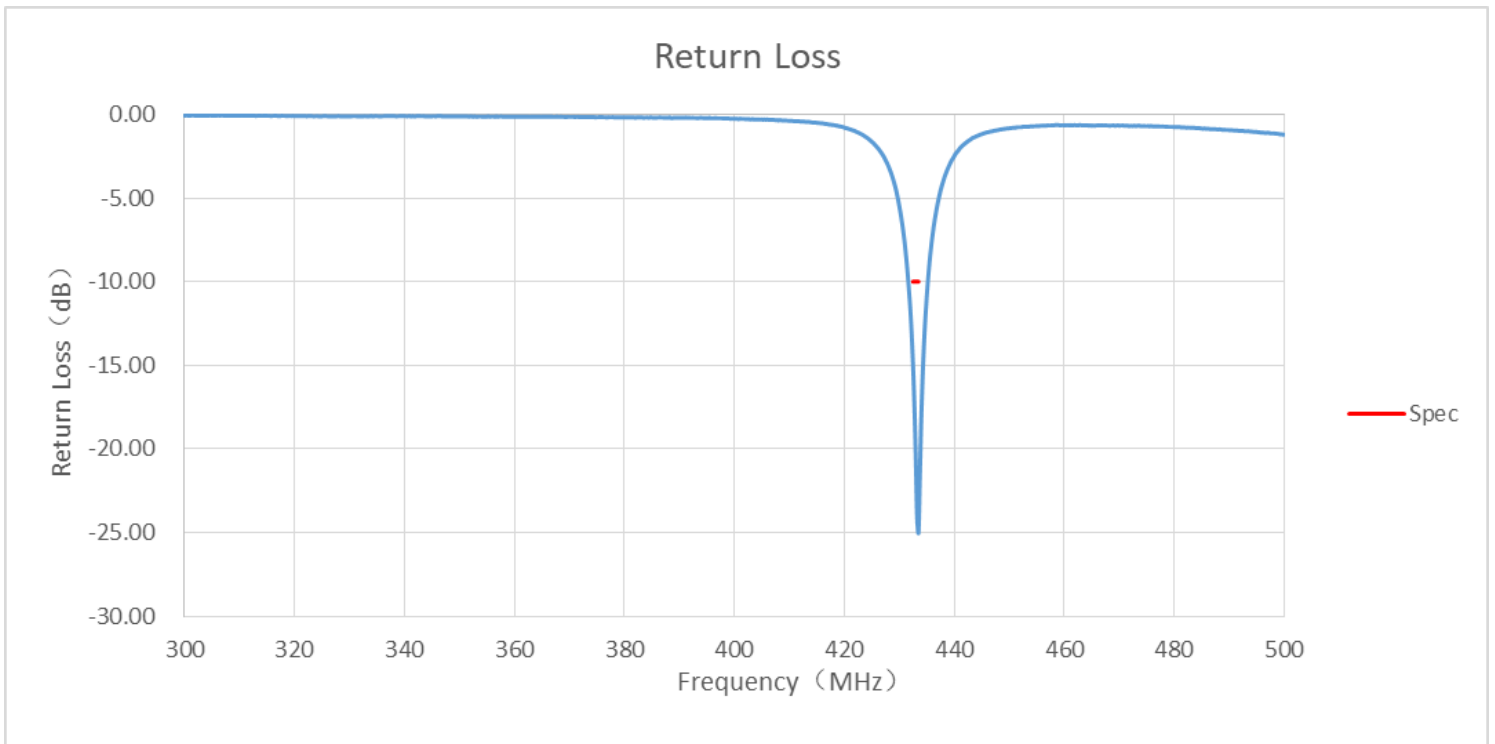

Issue: 2035

In the effort to improve our products, we reserve the right to make changes judged to be necessary.

CONFIDENTIAL AND PROPRIETARY INFORMATION

This document contains confidential and proprietary information of Pulse Electronics, Inc. (Pulse) and is protected by copyright, trade secret and other state and federal laws. Its receipt or possession does not convey any rights to reproduce, disclose its contents, or to manufacture, use or sell anything it may describe. Reproduction, disclosure or use without specific written authorization of Pulse is strictly forbidden.



**Description: ISM433MHz Embedded Antenna**

**Series: Ceramic Antenna**

**PART NUMBER: W3015L**

**CHARTS**

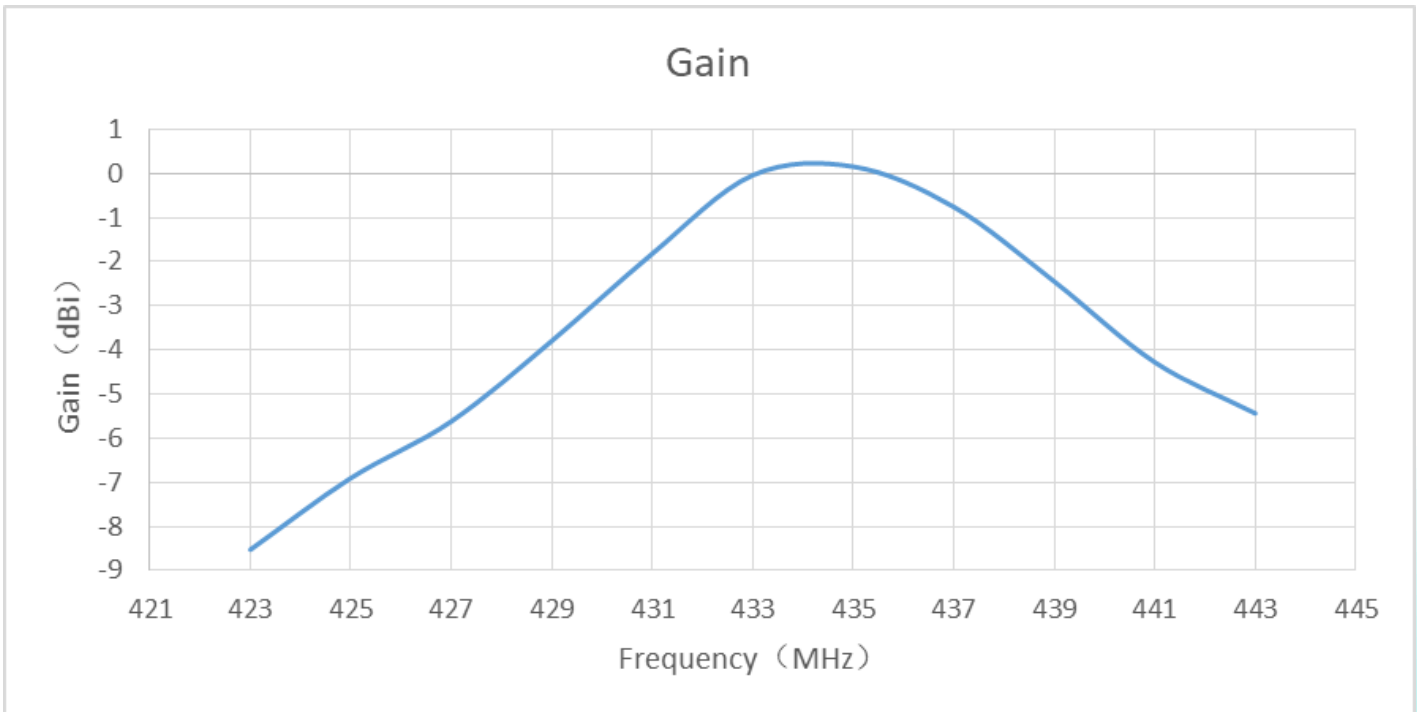
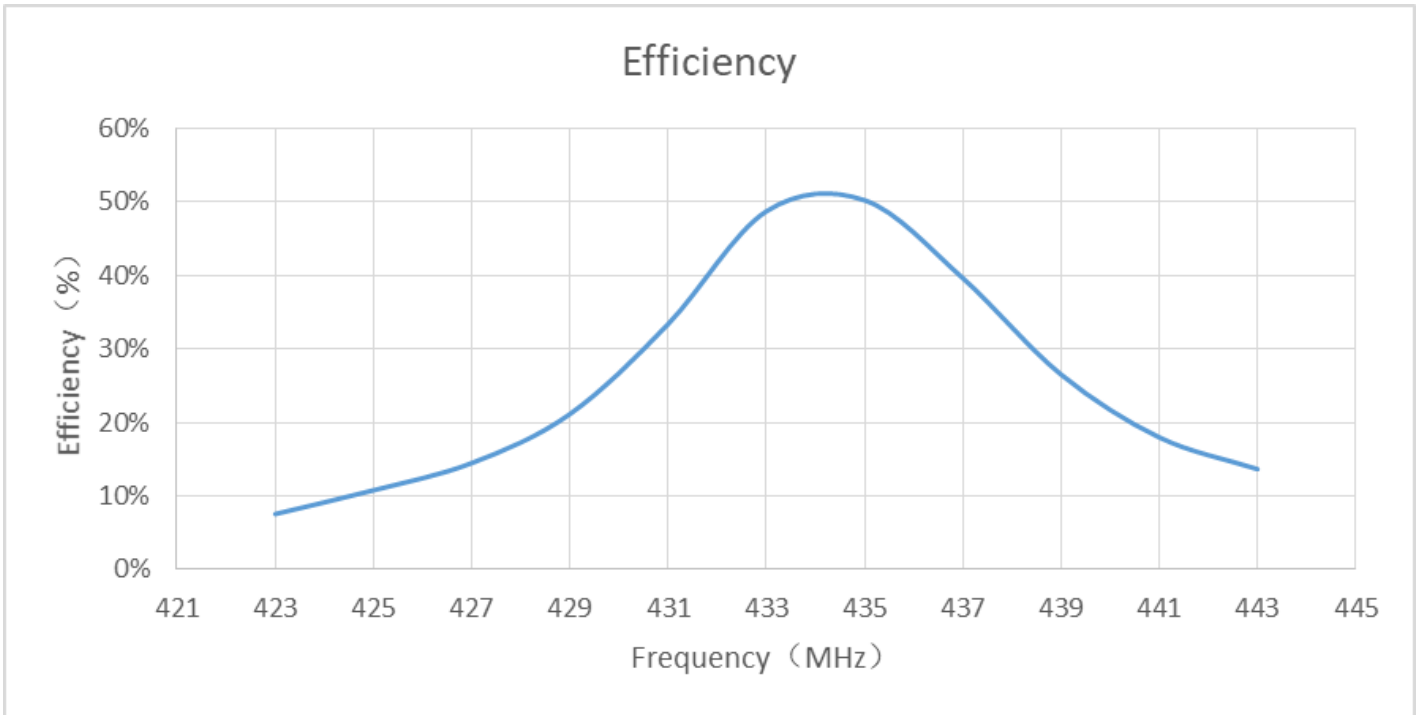

Issue: 2035

In the effort to improve our products, we reserve the right to make changes judged to be necessary.

CONFIDENTIAL AND PROPRIETARY INFORMATION

This document contains confidential and proprietary information of Pulse Electronics, Inc. (Pulse) and is protected by copyright, trade secret and other state and federal laws. Its receipt or possession does not convey any rights to reproduce, disclose its contents, or to manufacture, use or sell anything it may describe. Reproduction, disclosure or use without specific written authorization of Pulse is strictly forbidden.



Description: ISM433MHz Embedded Antenna

Series: Ceramic Antenna

PART NUMBER: W3015L

CHARTS

Typical free space radiation pattern

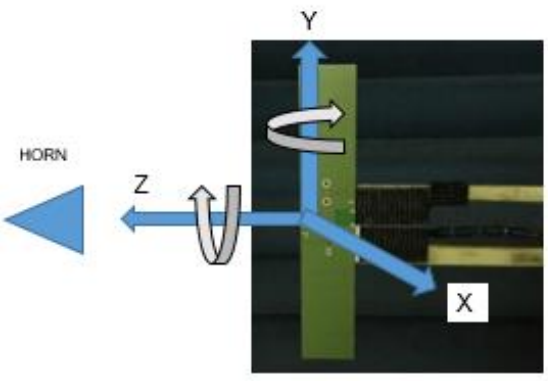
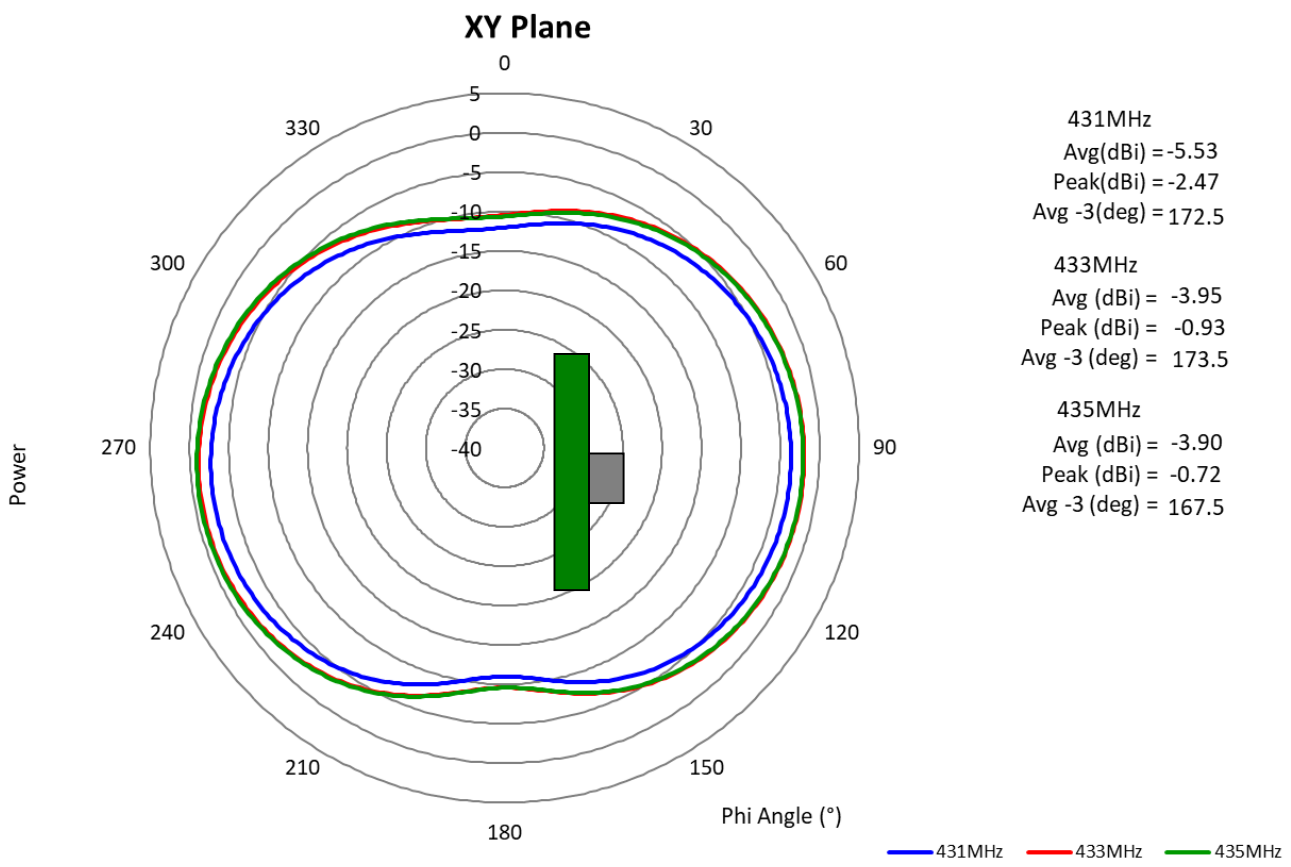

Issue: 2035

In the effort to improve our products, we reserve the right to make changes judged to be necessary.  
CONFIDENTIAL AND PROPRIETARY INFORMATION

This document contains confidential and proprietary information of Pulse Electronics, Inc. (Pulse) and is protected by copyright, trade secret and other state and federal laws. Its receipt or possession does not convey any rights to reproduce, disclose its contents, or to manufacture, use or sell anything it may describe. Reproduction, disclosure or use without specific written authorization of Pulse is strictly forbidden.

Description: ISM433MHz Embedded Antenna

Series: Ceramic Antenna

PART NUMBER: W3015L

CHARTS

Typical free space radiation pattern

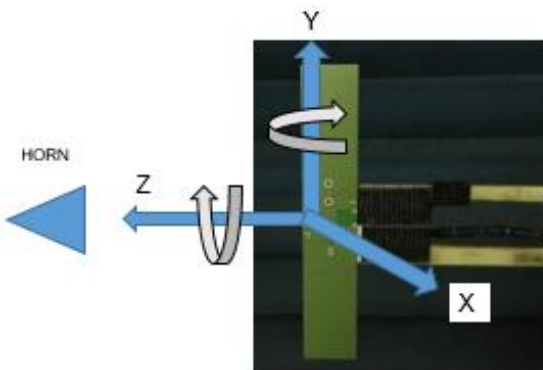
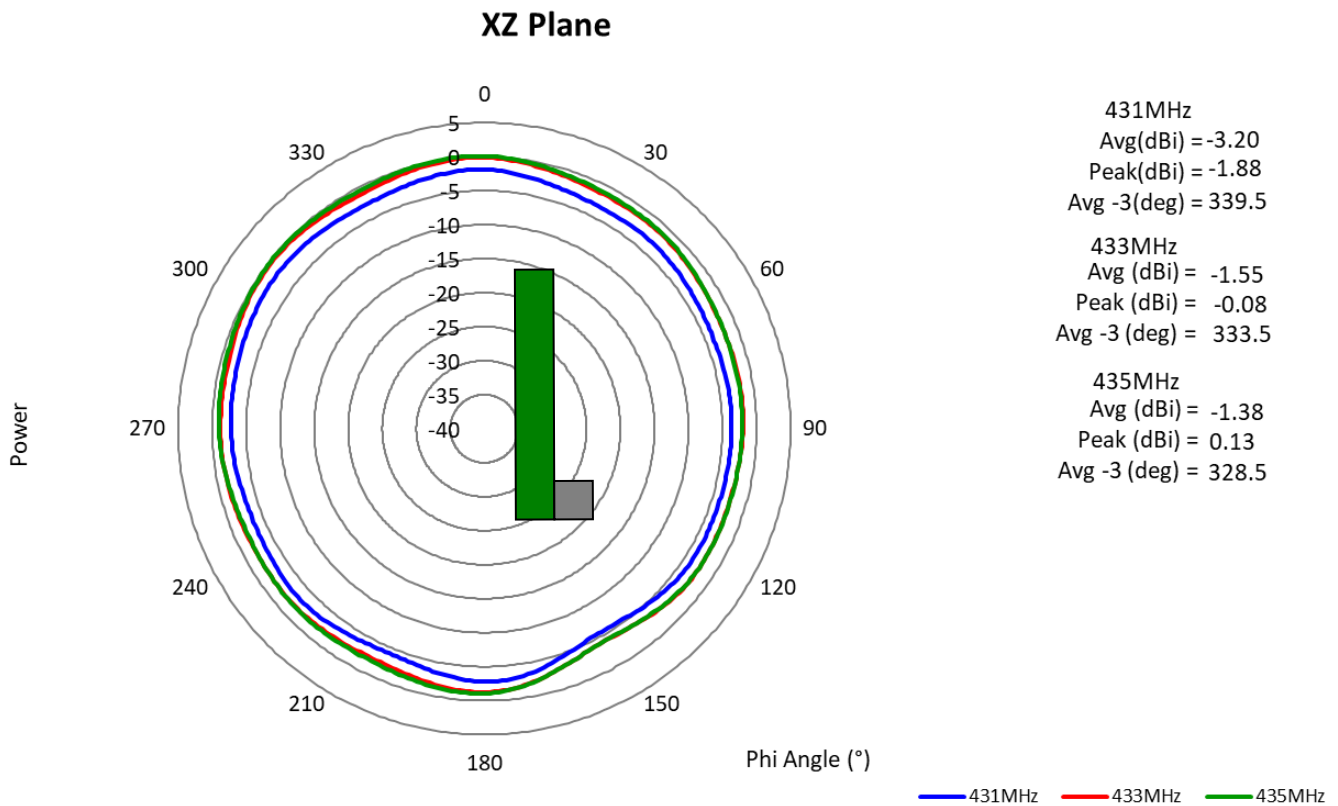

Issue: 2035

In the effort to improve our products, we reserve the right to make changes judged to be necessary.

CONFIDENTIAL AND PROPRIETARY INFORMATION

This document contains confidential and proprietary information of Pulse Electronics, Inc. (Pulse) and is protected by copyright, trade secret and other state and federal laws. Its receipt or possession does not convey any rights to reproduce, disclose its contents, or to manufacture, use or sell anything it may describe. Reproduction, disclosure or use without specific written authorization of Pulse is strictly forbidden.

Description: ISM433MHz Embedded Antenna

Series: Ceramic Antenna

PART NUMBER: W3015L

CHARTS

Typical free space radiation pattern

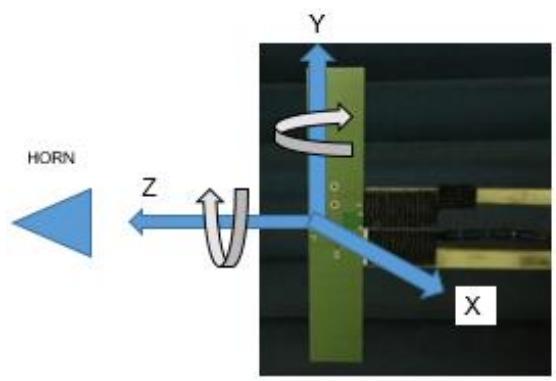
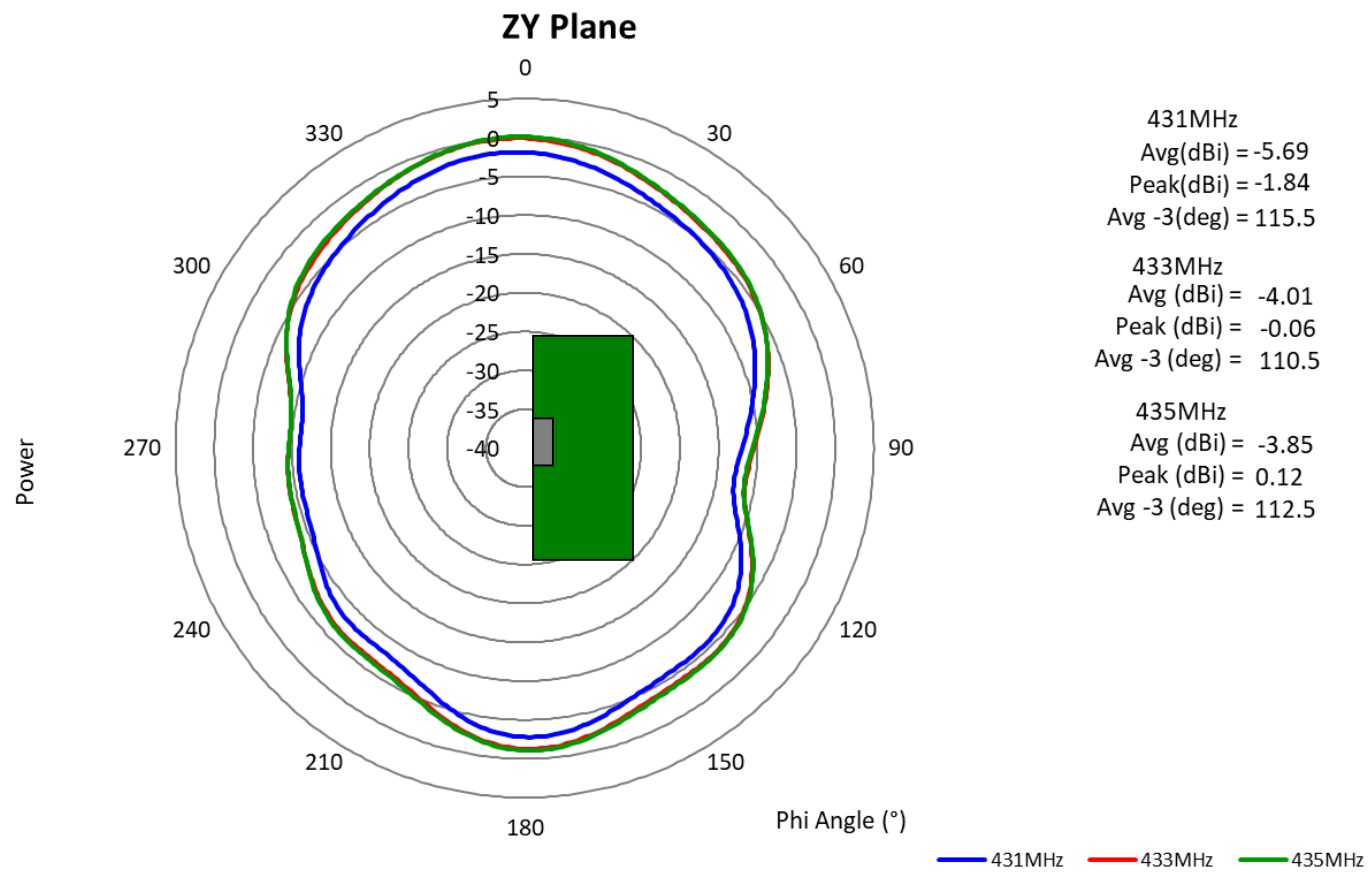

Issue: 2035

In the effort to improve our products, we reserve the right to make changes judged to be necessary.

CONFIDENTIAL AND PROPRIETARY INFORMATION  
This document contains confidential and proprietary information of Pulse Electronics, Inc. (Pulse) and is protected by copyright, trade secret and other state and federal laws. Its receipt or possession does not convey any rights to reproduce, disclose its contents, or to manufacture, use or sell anything it may describe. Reproduction, disclosure or use without specific written authorization of Pulse is strictly forbidden.

Description: ISM433MHz Embedded Antenna

Series: Ceramic Antenna

PART NUMBER: W3015L

**PACKAGING**

**General**

Tape and reel packing is used. Carrier tape, reel and box dimensions are presented in following pictures.

**Carrier Tape**

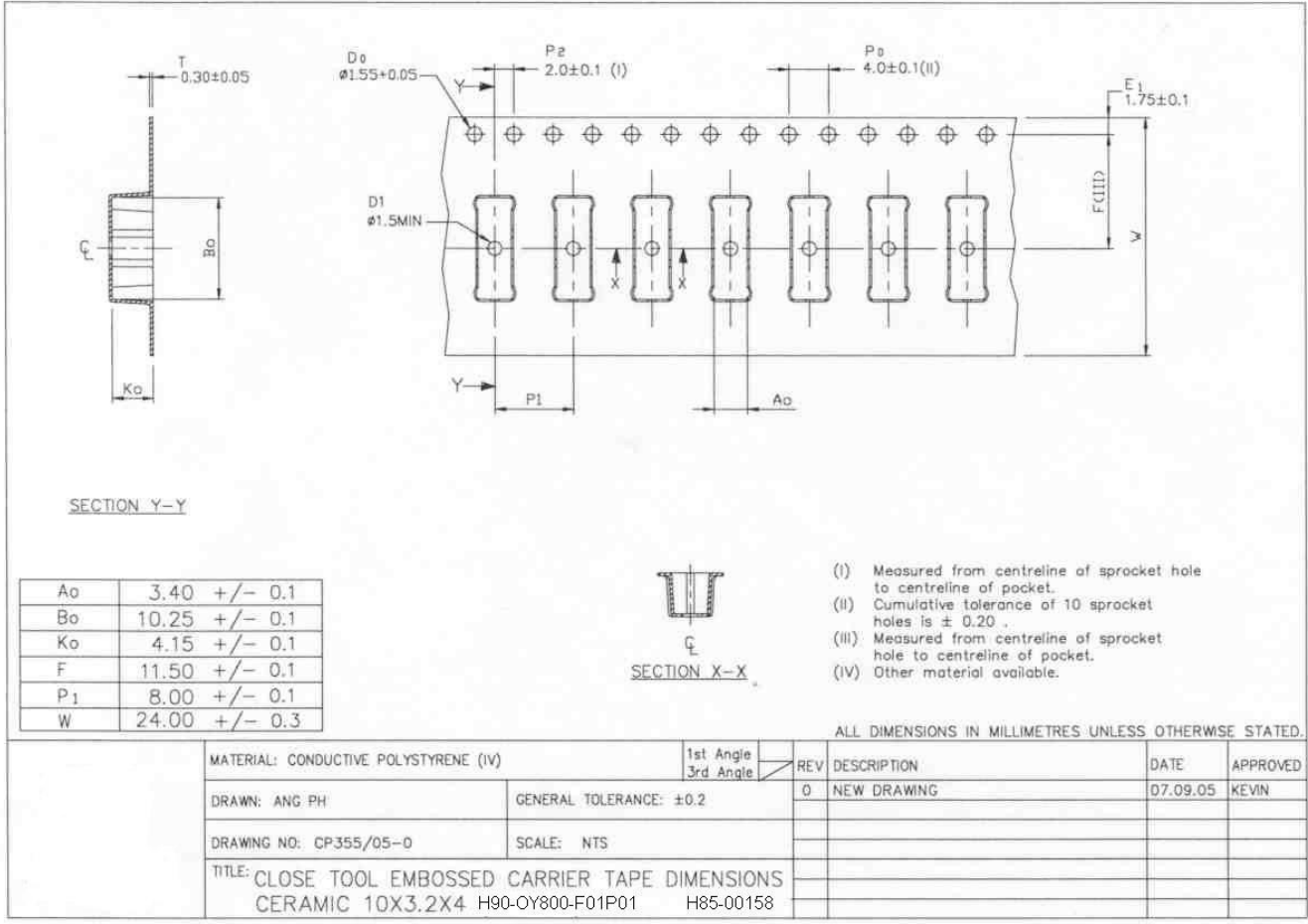

Issue: 2035

In the effort to improve our products, we reserve the right to make changes judged to be necessary.  
CONFIDENTIAL AND PROPRIETARY INFORMATION

This document contains confidential and proprietary information of Pulse Electronics, Inc. (Pulse) and is protected by copyright, trade secret and other state and federal laws. Its receipt or possession does not convey any rights to reproduce, disclose its contents, or to manufacture, use or sell anything it may describe. Reproduction, disclosure or use without specific written authorization of Pulse is strictly forbidden.

**Description: ISM433MHz Embedded Antenna**

**Series: Ceramic Antenna**

**PART NUMBER: W3015L**

**Packing form**

**500pcs in one Reel,  
3 reel in one inbox (1500 pcs),  
2 inbox in out box (3000pcs)**

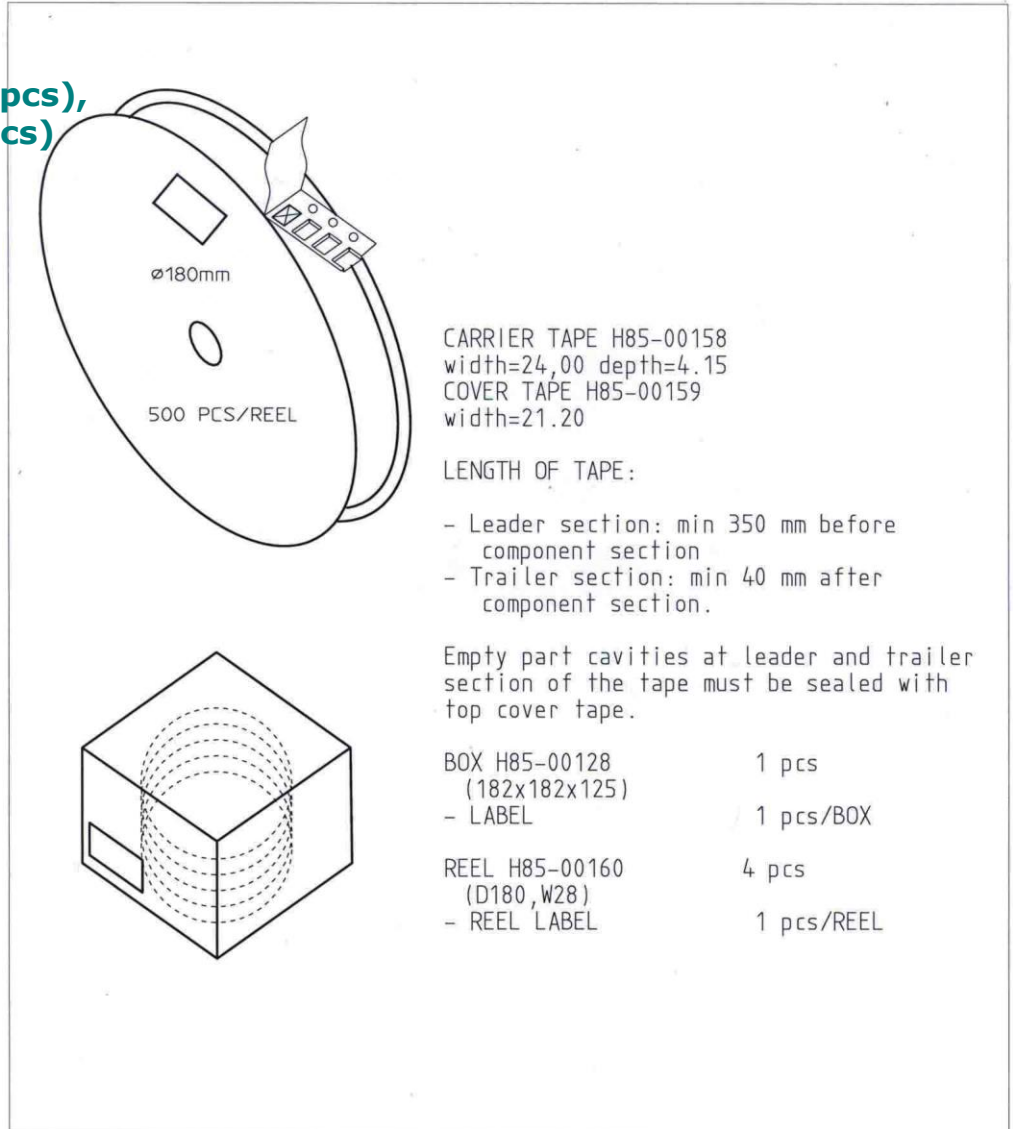

CARRIER TAPE H85-00158  
width=24,00 depth=4.15  
COVER TAPE H85-00159  
width=21.20

LENGTH OF TAPE:

- Leader section: min 350 mm before component section
- Trailer section: min 40 mm after component section.

Empty part cavities at leader and trailer section of the tape must be sealed with top cover tape.

- BOX H85-00128 1 pcs  
(182x182x125)
- LABEL 1 pcs/BOX
- REEL H85-00160 4 pcs  
(D180, W28)
- REEL LABEL 1 pcs/REEL

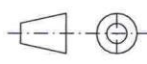
MATERIAL							
HANDLINGS							
		RATIO	DRWN	160107	PeHa	H	
			DGNER			G	
			CHKD			F	
			APPRD			E	
			APPRD BY			D	
PRODUCT			H90-OY800-F01P01			C	
DENOMINATION			PACKING FORM			B	
						A	
			VERSION			MOD/DATE/NAME	

Issue: 2035

In the effort to improve our products, we reserve the right to make changes judged to be necessary.

CONFIDENTIAL AND PROPRIETARY INFORMATION

This document contains confidential and proprietary information of Pulse Electronics, Inc. (Pulse) and is protected by copyright, trade secret and other state and federal laws. Its receipt or possession does not convey any rights to reproduce, disclose its contents, or to manufacture, use or sell anything it may describe. Reproduction, disclosure or use without specific written authorization of Pulse is strictly forbidden.

## Description: ISM433MHz Embedded Antenna

Series: Ceramic Antenna

PART NUMBER: W3015L

### Recommendations for ceramic chip antenna storage

#### Storage time

Products should be used within 6 months from the day of manufacturers packaging even when they are stored under below mentioned conditions. Longer storage period may decrease the component solderability.

#### Storage environmental conditions

To maintain solderability of Pulse ceramic products care must be taken to control the storage and use conditions:

- Do not store or use products in a corrosive atmosphere, especially where chloride, sulphur or sulfide, alkali or acid salts exist in the air. Corrosive gases may cause oxidation of electrodes and reduce solderability
- Keep temperature and humidity stable and do not exceed the below mentioned minimum and maximum conditions: Temperature: -10 to +30 Deg C  
Humidity: below 60% RH
- Do not store the products under direct sun light.

It is recommended to keep the products in manufacturers packing (tape&reel) until the time of assembly and soldering process. Air tight vacuum package is recommended in the conditions where it is know to be some corrosive gases.

#### Handling

Do not touch the components with bare hands. Protective gloves must be used to prevent contamination of terminals which may cause reduced solderability. Do not touch or damage the silver plated surface by any sharp objects. Soft materials (plastic, wood etc.) must be used if tweezers or other tools are used to pick the components. Avoid any excess mechanical shock or vibration during storage and handling.

Issue: 2035

In the effort to improve our products, we reserve the right to make changes judged to be necessary.

CONFIDENTIAL AND PROPRIETARY INFORMATION

This document contains confidential and proprietary information of Pulse Electronics, Inc. (Pulse) and is protected by copyright, trade secret and other state and federal laws. Its receipt or possession does not convey any rights to reproduce, disclose its contents, or to manufacture, use or sell anything it may describe. Reproduction, disclosure or use without specific written authorization of Pulse is strictly forbidden.

## Description: ISM433MHz Embedded Antenna

Series: Ceramic Antenna

PART NUMBER: W3015L

### Recommendation for reflow soldering process

Printing stencil thickness 0,15 - 0,25 mm is recommended for the solder paste. The maximum soldering temperature should not exceed 260°C. The temperature profile recommendations for reflow soldering process is presented in the Figures 1 and 2. The reflow profile

presented in figure 1 describes minimum reflow temperatures. The reflow profile presented in figure 2 describes maximum reflow temperatures. located at the center of the coverage area.

	Method of heat transfer	Controlled hot air convection
1	Average temperature gradient in preheating	2.5 °C/s
2	Soak time	2-3 minutes
3	Max temperature gradient in reflow	3 °C/s
4	Time above 217 °C	Max 30 sec
5	Peak temperature in reflow	230 °C for 10 seconds
6	Temperature gradient in cooling	Max -5 °C/s

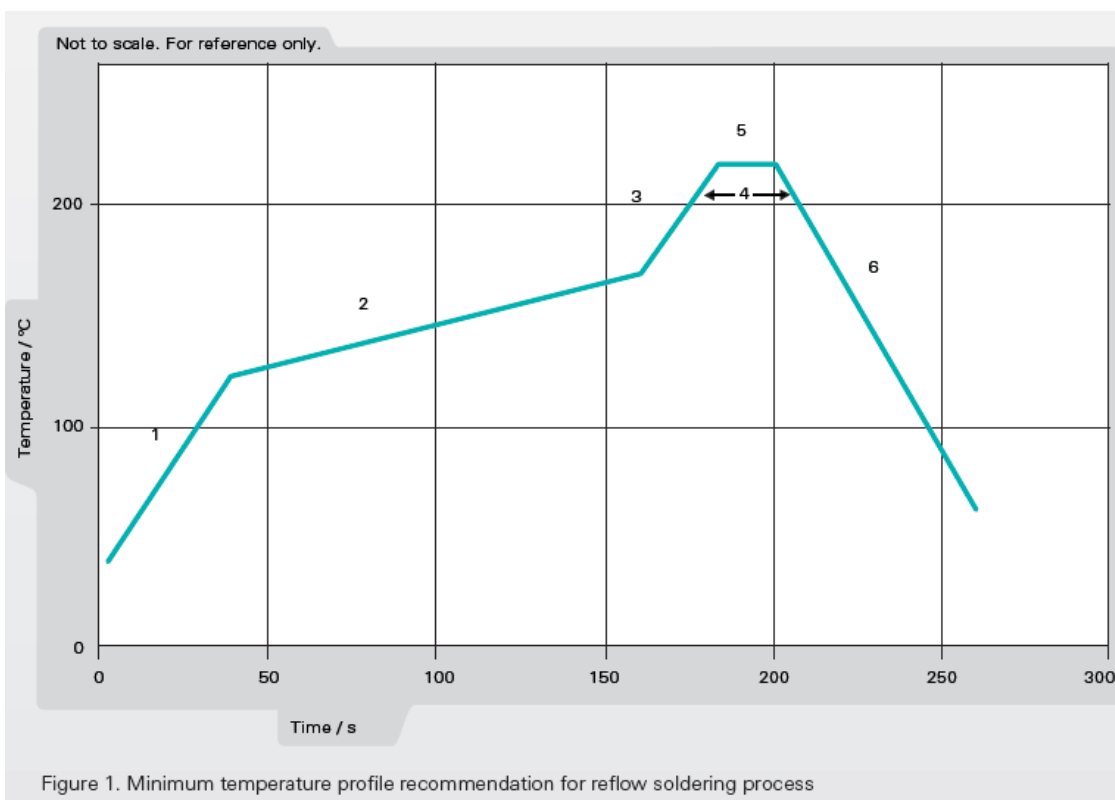

Issue: 2035

In the effort to improve our products, we reserve the right to make changes judged to be necessary.

CONFIDENTIAL AND PROPRIETARY INFORMATION

This document contains confidential and proprietary information of Pulse Electronics, Inc. (Pulse) and is protected by copyright, trade secret and other state and federal laws. Its receipt or possession does not convey any rights to reproduce, disclose its contents, or to manufacture, use or sell anything it may describe. Reproduction, disclosure or use without specific written authorization of Pulse is strictly forbidden.