

Description: ISM 169/433/868/915/2450MHz
Helical Antenna

Series: Helix Coil

PART NUMBER: W3100X



W3100



W3100A



W3100B



W3100C



W3100D

Features:

- Helix coil with shrink tube
- Antenna type Monopole
- Diameter 9.8 mm
- Coil cut to operating freq:
 - 169MHz 80mm, P/N W3100
 - 433MHz 30mm, P/N W3100A
 - 868MHz 11mm, P/N W3100B
 - 915MHz 10mm, P/N W3100C
 - 2450MHz 2.5mm, P/N W3100D

Applications:

- ISM band radios
- IoT
- Smart Meters
- Easy to cut for optimal length in variety of applications
- Fine tuning and impedance matching with PCB SMT components

All dimensions are in mm / inches

Issue: 1851

In the effort to improve our products, we reserve the right to make changes judged to be necessary.

CONFIDENTIAL AND PROPRIETARY INFORMATION

This document contains confidential and proprietary information of Pulse Electronics, Inc. (Pulse) and is protected by copyright, trade secret and other state and federal laws. Its receipt or possession does not convey any rights to reproduce, disclose its contents, or to manufacture, use or sell anything it may describe. Reproduction, disclosure or use without specific written authorization of Pulse is strictly forbidden.

For more information:

Pulse Worldwide Headquarters
12220 World Trade Drive
San Diego, CA 92128
USA
Tel: 1-858-674-8100

Pulse/Larsen Antennas
18110 SE 34th St Bldg 2 Suite 250
Vancouver, WA 98683
USA
Tel: 1-360-944-7551

Europe Headquarters
Pulse GmbH & Do, KG
Zeppelinstrasse 15
Herrenberg, Germany
Tel: 49 7032 7806 0

Pulse (Suzhou) Wireless Products Co, Inc.
99 Huo Ju Road(#29 Bldg,4th Phase
Suzhou New District
Jiangsu Province, Suzhou 215009 PR China
Tel: 86 512 6807 9998



Series: Helix Coil

Description: ISM 169/433/868/915/2450MHz
Helical Antenna

PART NUMBER: W3100X

ELECTRICAL SPECIFICATIONS

Antenna Type	Helix monopole coil
Frequency	169, 433, 868, 915, 2450MHz
Nominal Impedance	50 Ω
VSWR	2:1
Radiation Pattern	Omn
Gain	-4dBi @ 169MHz -2.9dBi @ 433MHz 0dBi @ 868MHz -0.5dBi @ 915MHz 3.5dBi @ 2450MHz
Efficiency	20% @ 169MHz 25% @ 433MHz 35% @ 868MHz 35% @ 915MHz 80% @ 2450MHz
Polarization	Vertical
Power Withstanding	2W

MECHANICAL SPECIFICATIONS

Coil Length	See table
Antenna Color	Black radome
Mounting method	Mechanical lock on PCB, soldering
Weight	10.2g/2.0g/0.5g/0.45g/0.2g

ENVIRONMENTAL SPECIFICATIONS

Operating Temperature	-40 - +85 ° C
Storage Temperature	-40 - +85 ° C
RoHS Compliant	Yes

Issue: 1851

In the effort to improve our products, we reserve the right to make changes judged to be necessary.

CONFIDENTIAL AND PROPRIETARY INFORMATION

This document contains confidential and proprietary information of Pulse Electronics, Inc. (Pulse) and is protected by copyright, trade secret and other state and federal laws. Its receipt or possession does not convey any rights to reproduce, disclose its contents, or to manufacture, use or sell anything it may describe. Reproduction, disclosure or use without specific written authorization of Pulse is strictly forbidden.

Description: ISM 169/433/868/915/2450MHz
Helical Antenna

Series: Helix Coil

PART NUMBER: W3100X

MECHANICAL DRAWING

W3100/W3100A/W3100B/W3100C

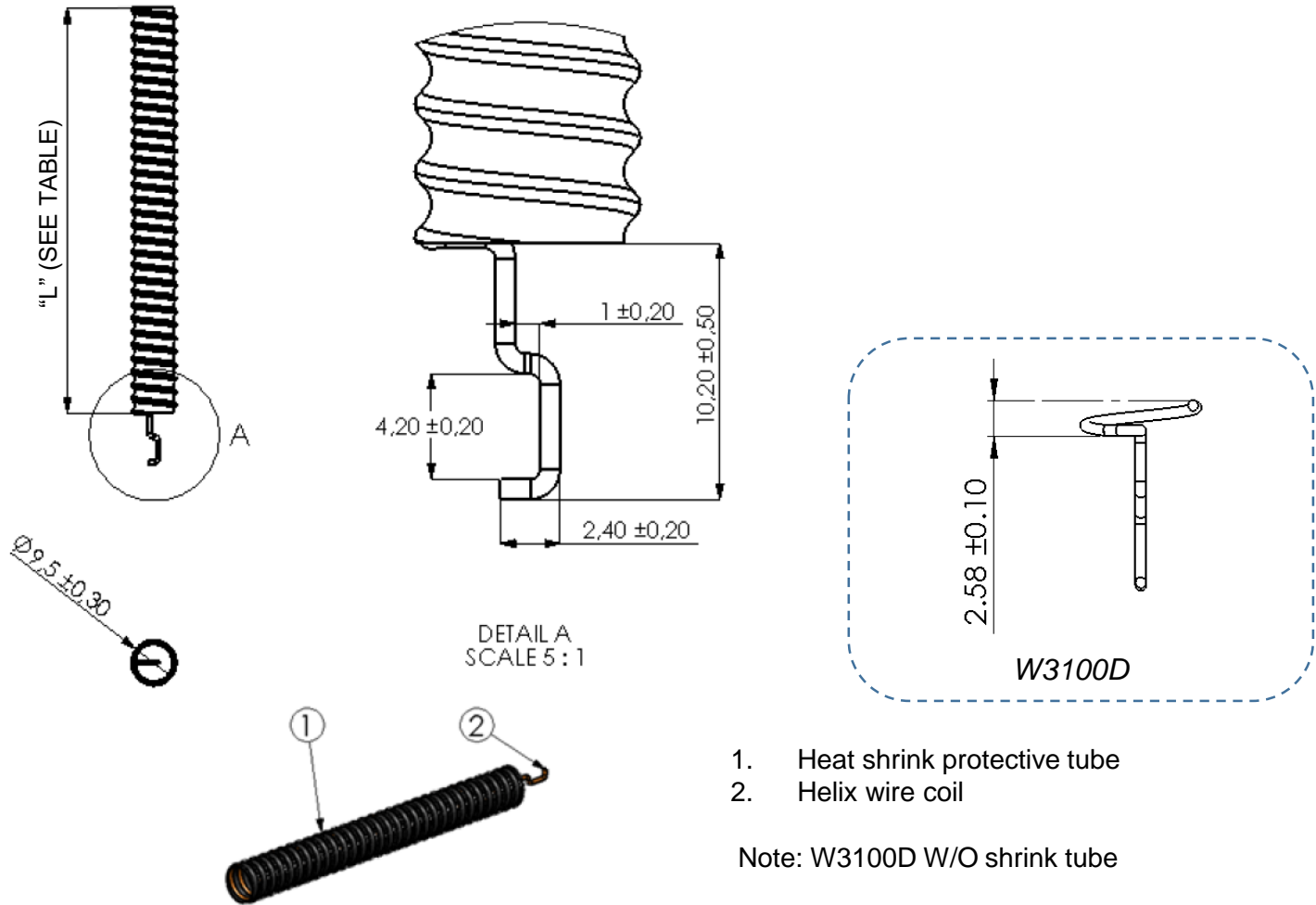

PN	"L"	Frequency
W3100	80 ± 2	169MHz
W3100A	30 ± 0.5	433MHZ
W3100B	11 ± 0.5	868MHz
W3100C	10 ± 0.5	915MHz
W3100D	2.5 ± 0.2	2450MHz

Issue: 1851

In the effort to improve our products, we reserve the right to make changes judged to be necessary.

CONFIDENTIAL AND PROPRIETARY INFORMATION

This document contains confidential and proprietary information of Pulse Electronics, Inc. (Pulse) and is protected by copyright, trade secret and other state and federal laws. Its receipt or possession does not convey any rights to reproduce, disclose its contents, or to manufacture, use or sell anything it may describe. Reproduction, disclosure or use without specific written authorization of Pulse is strictly forbidden.

Series: Helix Coil

Description: ISM 169/433/868/915/2450MHz
Helical Antenna

PART NUMBER: W3100X

MECHANICAL DRAWING AND TERMINAL CONFIGURATION

W3100

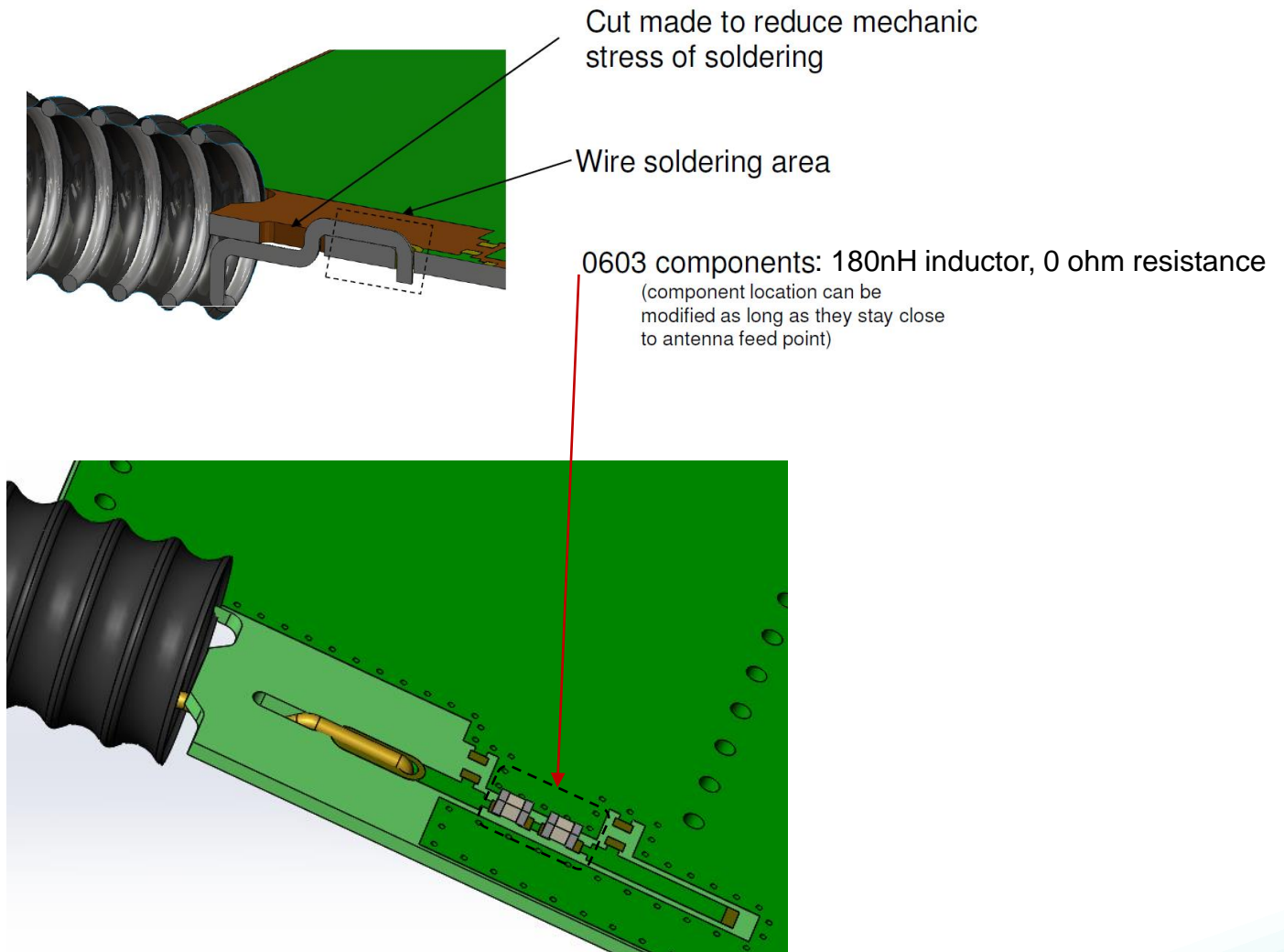

Issue: 1851

In the effort to improve our products, we reserve the right to make changes judged to be necessary.

CONFIDENTIAL AND PROPRIETARY INFORMATION

This document contains confidential and proprietary information of Pulse Electronics, Inc. (Pulse) and is protected by copyright, trade secret and other state and federal laws. Its receipt or possession does not convey any rights to reproduce, disclose its contents, or to manufacture, use or sell anything it may describe. Reproduction, disclosure or use without specific written authorization of Pulse is strictly forbidden.

Series: Helix Coil

Description: ISM 169/433/868/915/2450MHz
Helical Antenna

PART NUMBER: W3100X

MECHANICAL DRAWING AND TERMINAL CONFIGURATION

W3100 TEST BOARD

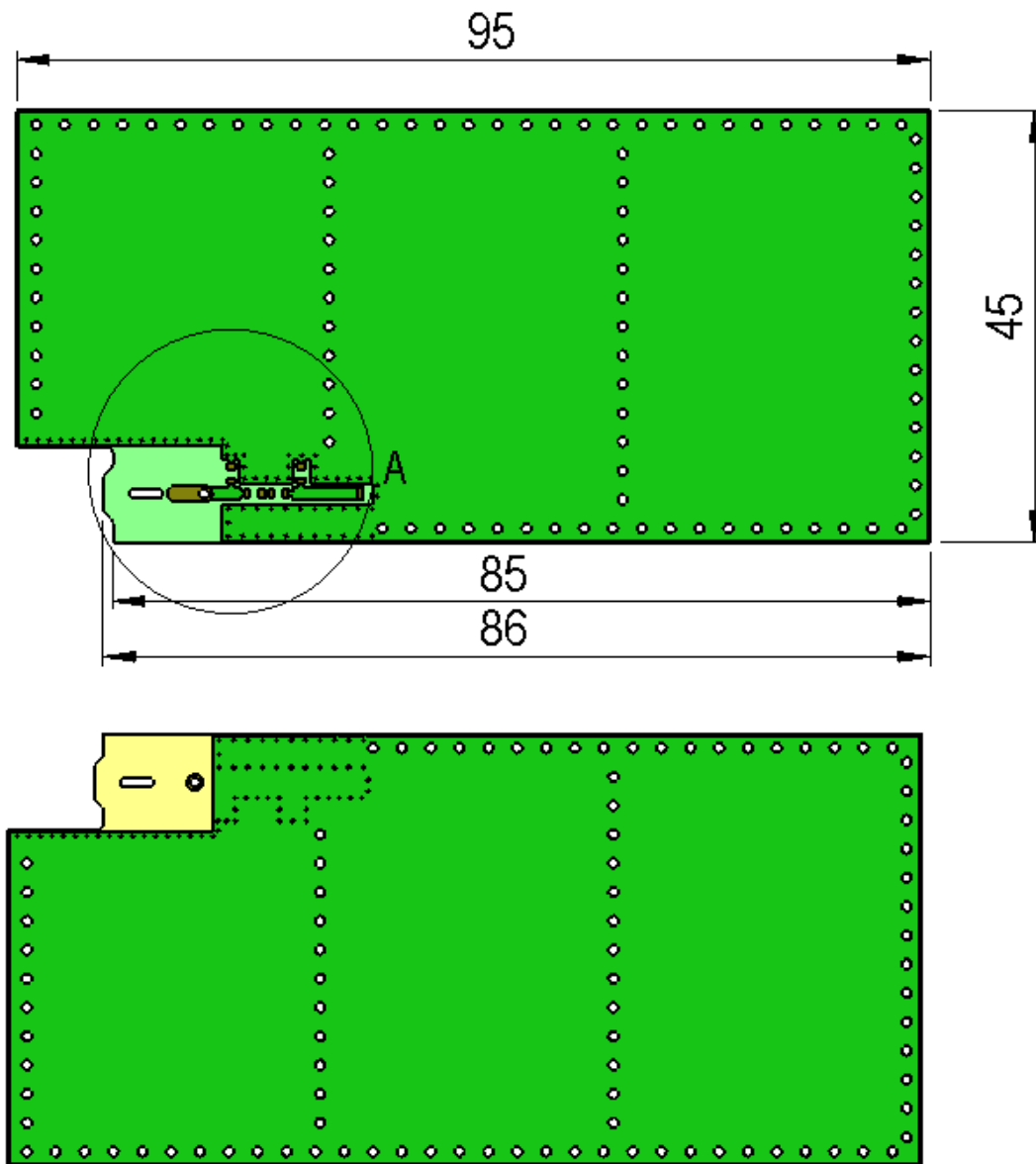

Issue: 1851

In the effort to improve our products, we reserve the right to make changes judged to be necessary.

CONFIDENTIAL AND PROPRIETARY INFORMATION

This document contains confidential and proprietary information of Pulse Electronics, Inc. (Pulse) and is protected by copyright, trade secret and other state and federal laws. Its receipt or possession does not convey any rights to reproduce, disclose its contents, or to manufacture, use or sell anything it may describe. Reproduction, disclosure or use without specific written authorization of Pulse is strictly forbidden.

Series: Helix Coil

Description: ISM 169/433/868/915/2450MHz
Helical Antenna

PART NUMBER: W3100X

MECHANICAL DRAWING AND TERMINAL CONFIGURATION

W3100 TEST BOARD

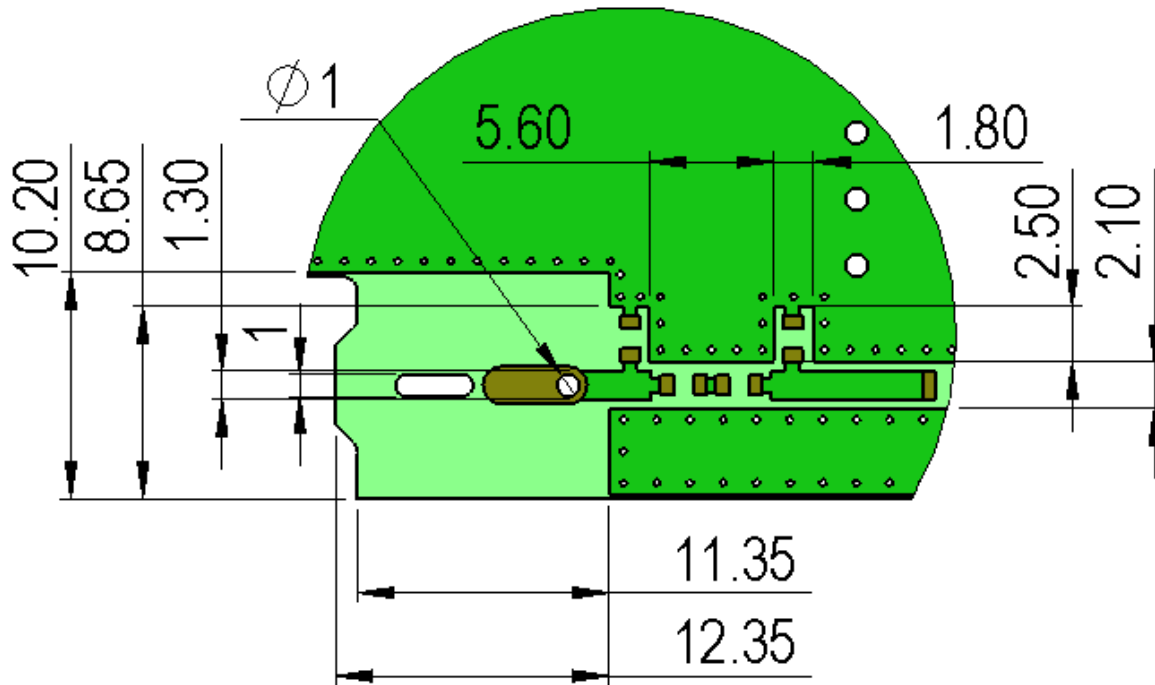

DETAIL A

Issue: 1851

In the effort to improve our products, we reserve the right to make changes judged to be necessary.

CONFIDENTIAL AND PROPRIETARY INFORMATION

This document contains confidential and proprietary information of Pulse Electronics, Inc. (Pulse) and is protected by copyright, trade secret and other state and federal laws. Its receipt or possession does not convey any rights to reproduce, disclose its contents, or to manufacture, use or sell anything it may describe. Reproduction, disclosure or use without specific written authorization of Pulse is strictly forbidden.

Series: Helix Coil

Description: ISM 169/433/868/915/2450MHz
Helical Antenna

PART NUMBER: W3100X

MECHANICAL DRAWING AND TERMINAL CONFIGURATION

W3100A/W3100B/W3100C/W3100D

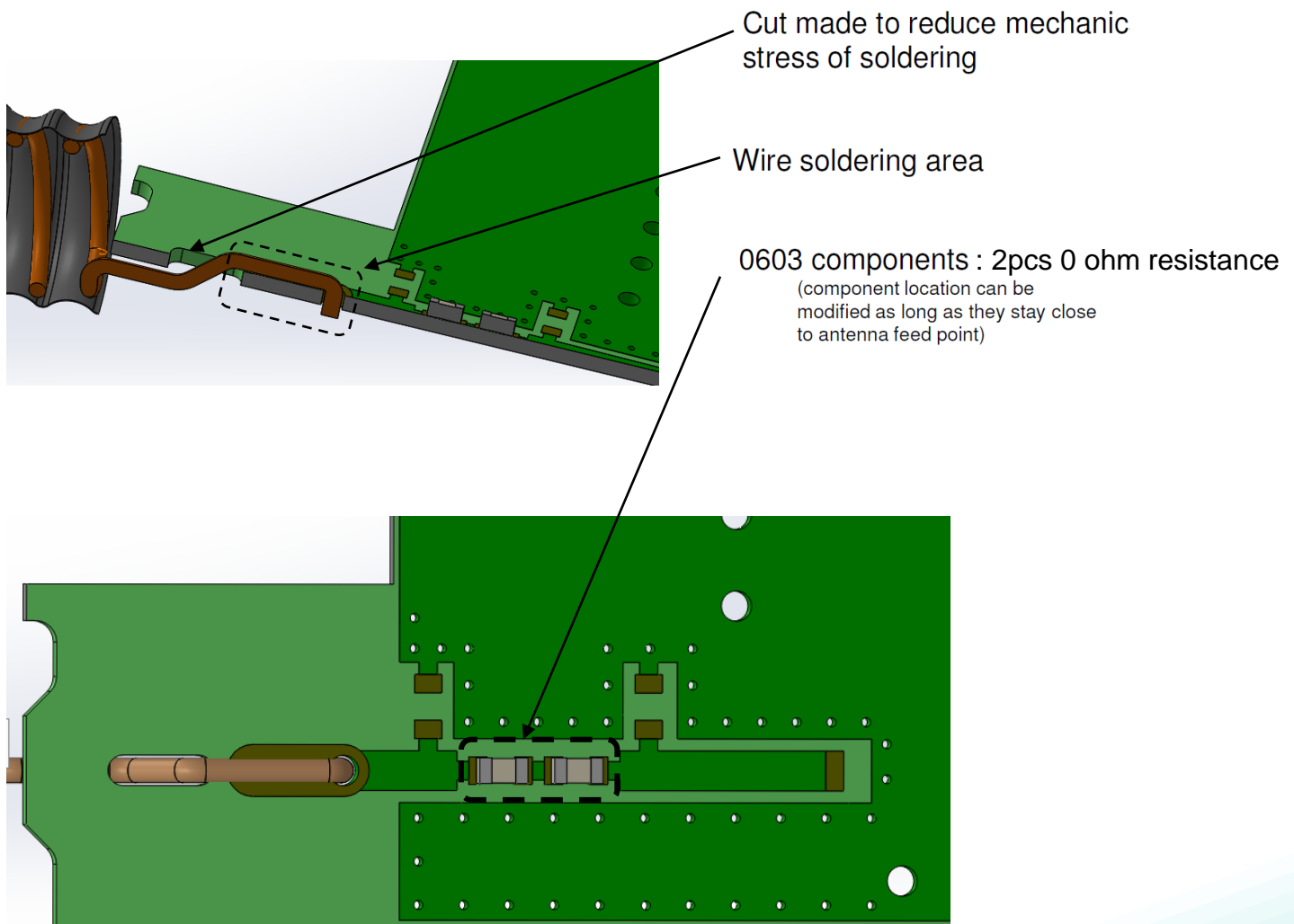

Issue: 1851

In the effort to improve our products, we reserve the right to make changes judged to be necessary.

CONFIDENTIAL AND PROPRIETARY INFORMATION

This document contains confidential and proprietary information of Pulse Electronics, Inc. (Pulse) and is protected by copyright, trade secret and other state and federal laws. Its receipt or possession does not convey any rights to reproduce, disclose its contents, or to manufacture, use or sell anything it may describe. Reproduction, disclosure or use without specific written authorization of Pulse is strictly forbidden.

Series: Helix Coil

Description: ISM 169/433/868/915/2450MHz
Helical Antenna

PART NUMBER: W3100X

MECHANICAL DRAWING AND TERMINAL CONFIGURATION

W3100A/W3100B/W3100C/W3100D TEST BOARD

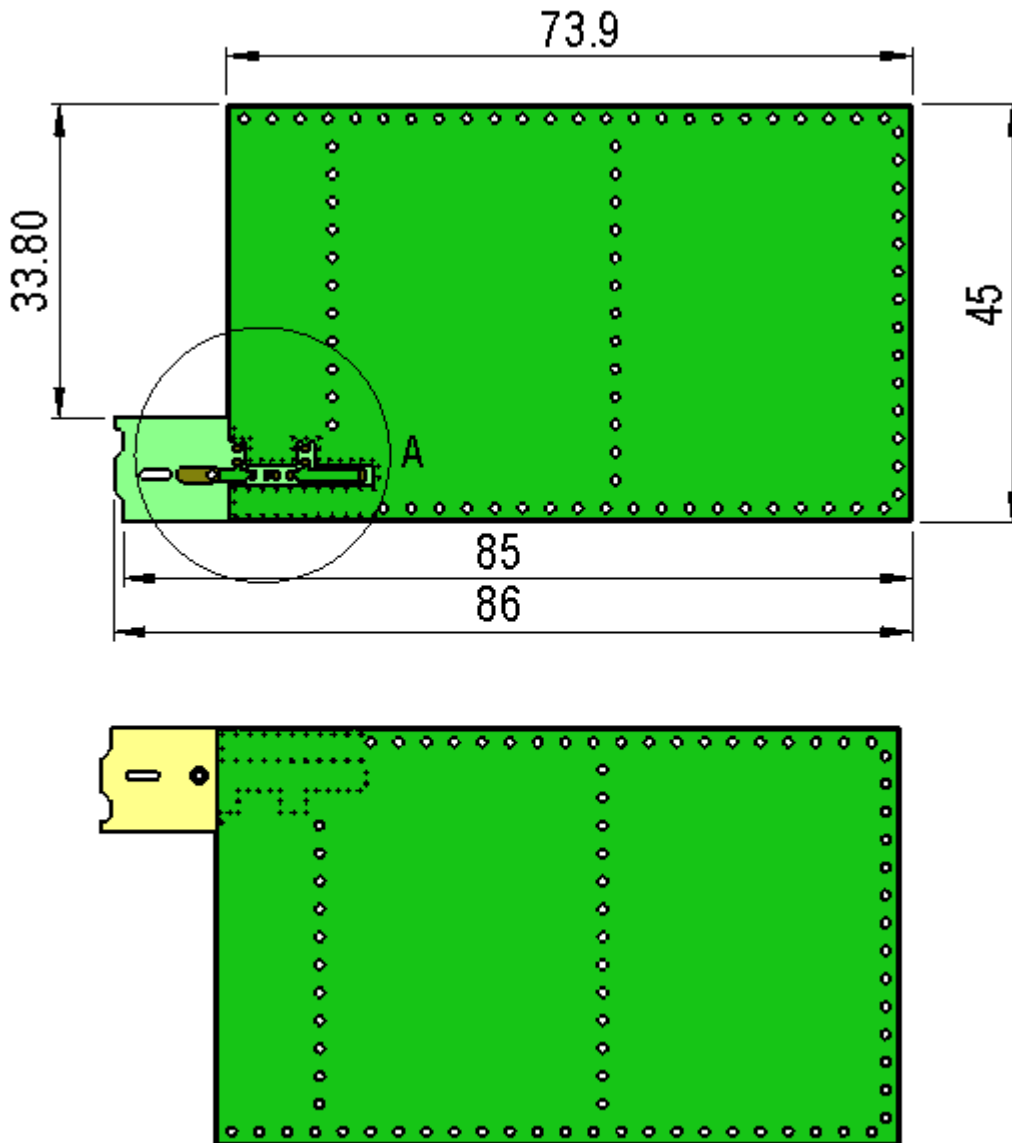

Issue: 1851

In the effort to improve our products, we reserve the right to make changes judged to be necessary.

CONFIDENTIAL AND PROPRIETARY INFORMATION

This document contains confidential and proprietary information of Pulse Electronics, Inc. (Pulse) and is protected by copyright, trade secret and other state and federal laws. Its receipt or possession does not convey any rights to reproduce, disclose its contents, or to manufacture, use or sell anything it may describe. Reproduction, disclosure or use without specific written authorization of Pulse is strictly forbidden.

Series: Helix Coil

Description: ISM 169/433/868/915/2450MHz
Helical Antenna

PART NUMBER: W3100X

MECHANICAL DRAWING AND TERMINAL CONFIGURATION

W3100A/W3100B/W3100C/W3100D TEST BOARD

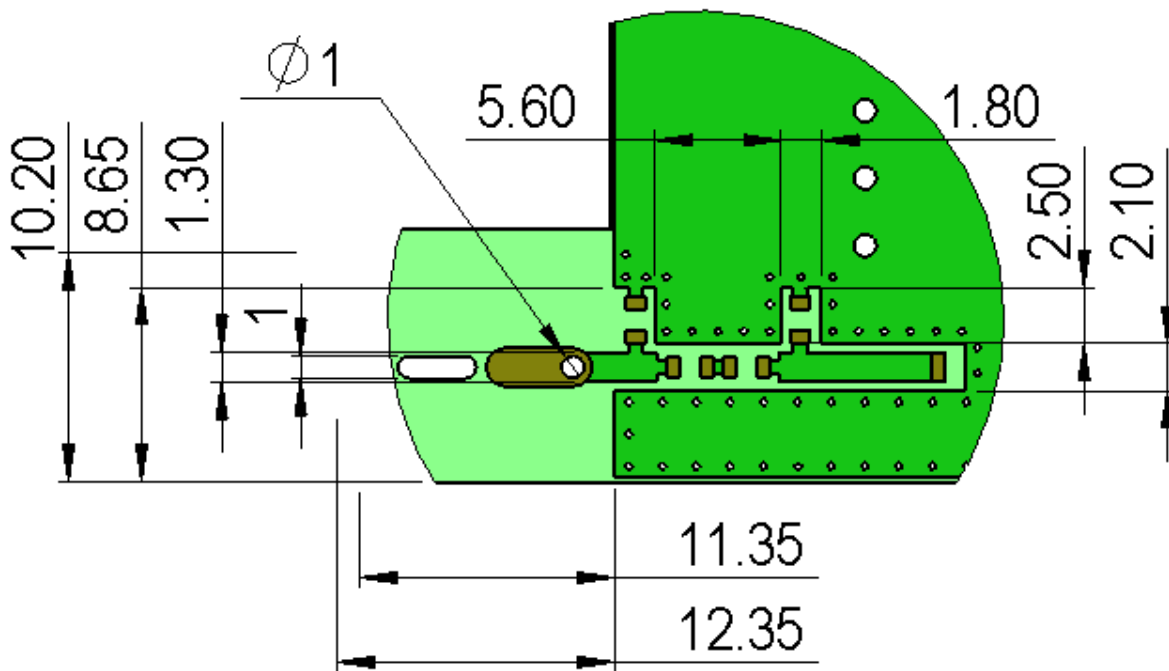

DETAIL A

Issue: 1851

In the effort to improve our products, we reserve the right to make changes judged to be necessary.

CONFIDENTIAL AND PROPRIETARY INFORMATION

This document contains confidential and proprietary information of Pulse Electronics, Inc. (Pulse) and is protected by copyright, trade secret and other state and federal laws. Its receipt or possession does not convey any rights to reproduce, disclose its contents, or to manufacture, use or sell anything it may describe. Reproduction, disclosure or use without specific written authorization of Pulse is strictly forbidden.

Series: Helix Coil

Description: ISM 169/433/868/915/2450MHz
Helical Antenna

PART NUMBER: W3100X

TEST SETUP

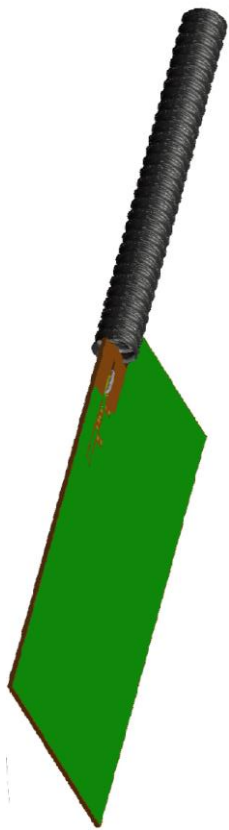

169MHz

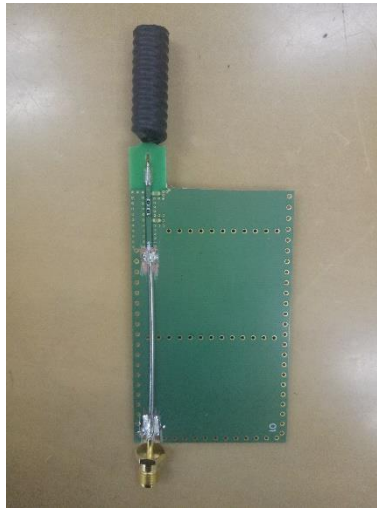

433MHz



868MHz



915MHz



2400MHz

Series: Helix Coil

Description: ISM 169/433/868/915/2450MHz
Helical Antenna

PART NUMBER: W3100X

CHARTS

W3100

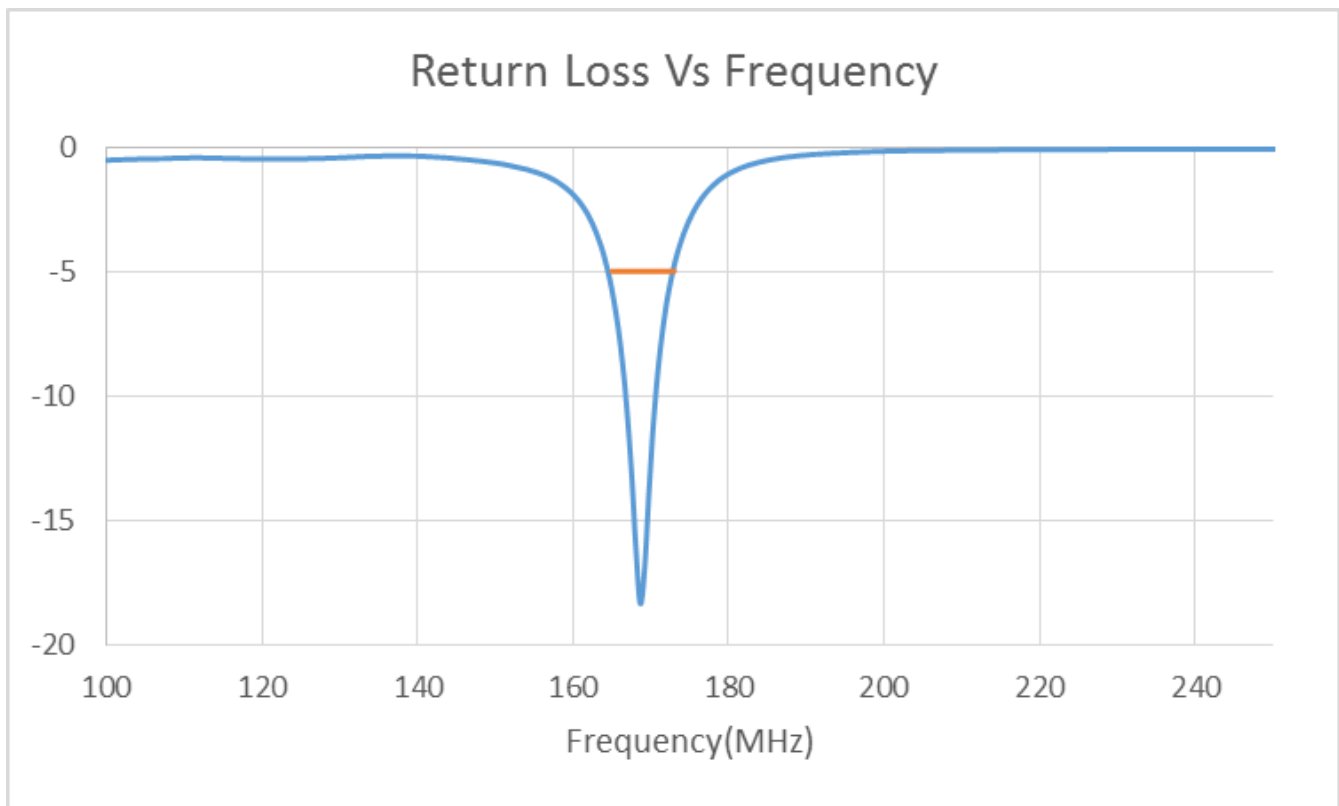

Issue: 1851

In the effort to improve our products, we reserve the right to make changes judged to be necessary.

CONFIDENTIAL AND PROPRIETARY INFORMATION

This document contains confidential and proprietary information of Pulse Electronics, Inc. (Pulse) and is protected by copyright, trade secret and other state and federal laws. Its receipt or possession does not convey any rights to reproduce, disclose its contents, or to manufacture, use or sell anything it may describe. Reproduction, disclosure or use without specific written authorization of Pulse is strictly forbidden.

Description: ISM 169/433/868/915/2450MHz
Helical Antenna

Series: Helix Coil

PART NUMBER: W3100X

CHARTS

W3100

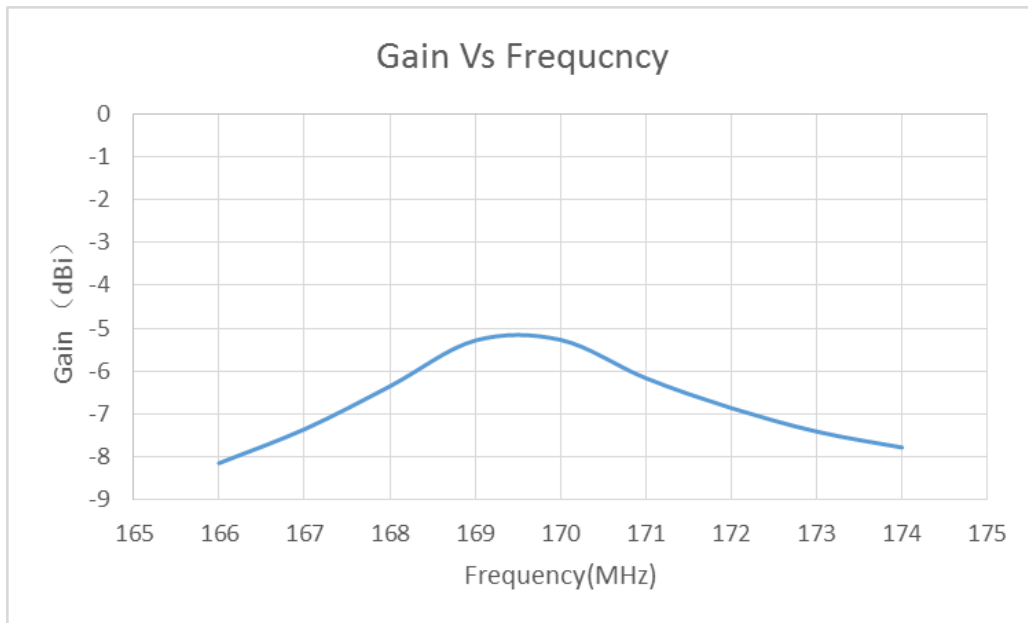
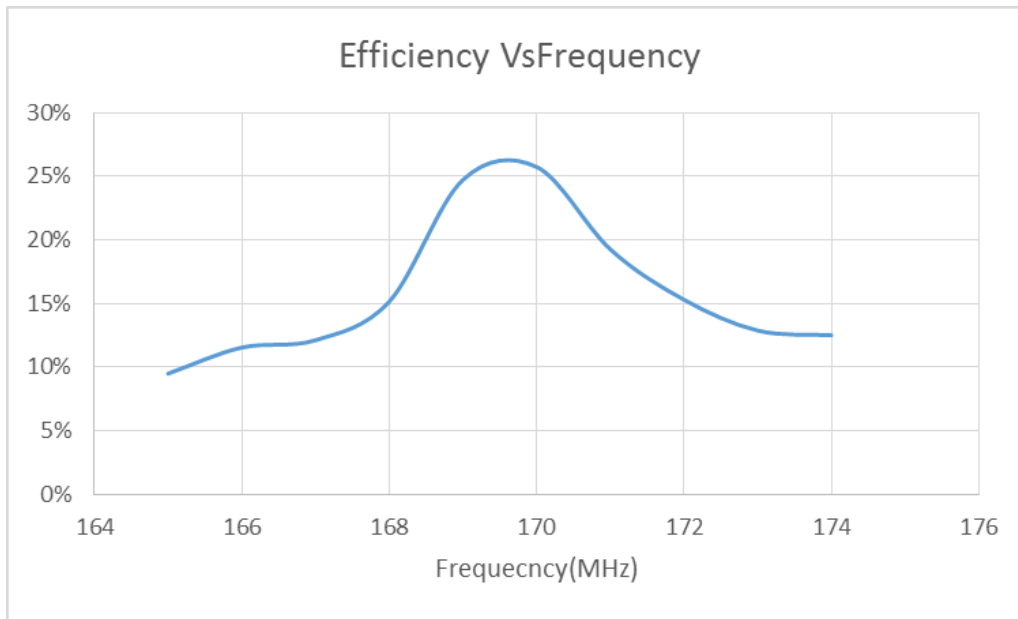

Issue: 1851

In the effort to improve our products, we reserve the right to make changes judged to be necessary.

CONFIDENTIAL AND PROPRIETARY INFORMATION

This document contains confidential and proprietary information of Pulse Electronics, Inc. (Pulse) and is protected by copyright, trade secret and other state and federal laws. Its receipt or possession does not convey any rights to reproduce, disclose its contents, or to manufacture, use or sell anything it may describe. Reproduction, disclosure or use without specific written authorization of Pulse is strictly forbidden.

Series: Helix Coil

Description: ISM 169/433/868/915/2450MHz
Helical Antenna

PART NUMBER: W3100X

CHARTS

W3100

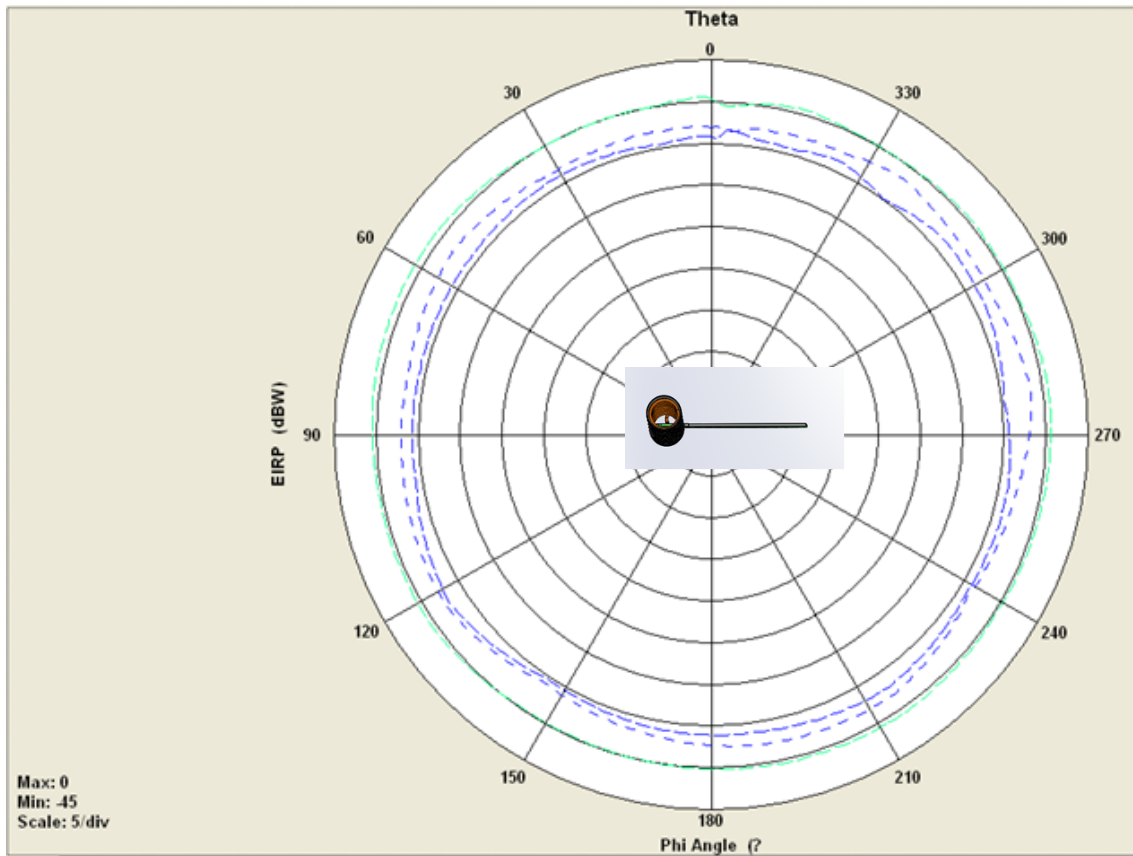

Issue: 1851

In the effort to improve our products, we reserve the right to make changes judged to be necessary.

CONFIDENTIAL AND PROPRIETARY INFORMATION

This document contains confidential and proprietary information of Pulse Electronics, Inc. (Pulse) and is protected by copyright, trade secret and other state and federal laws. Its receipt or possession does not convey any rights to reproduce, disclose its contents, or to manufacture, use or sell anything it may describe. Reproduction, disclosure or use without specific written authorization of Pulse is strictly forbidden.

Description: ISM 169/433/868/915/2450MHz
Helical Antenna

Series: Helix Coil

PART NUMBER: W3100X

CHARTS

W3100

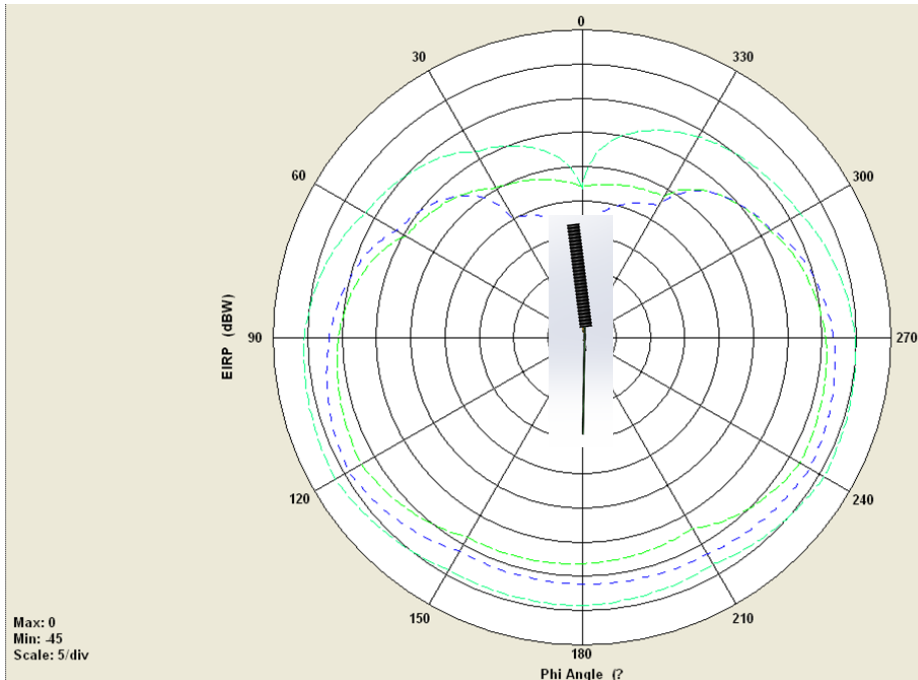
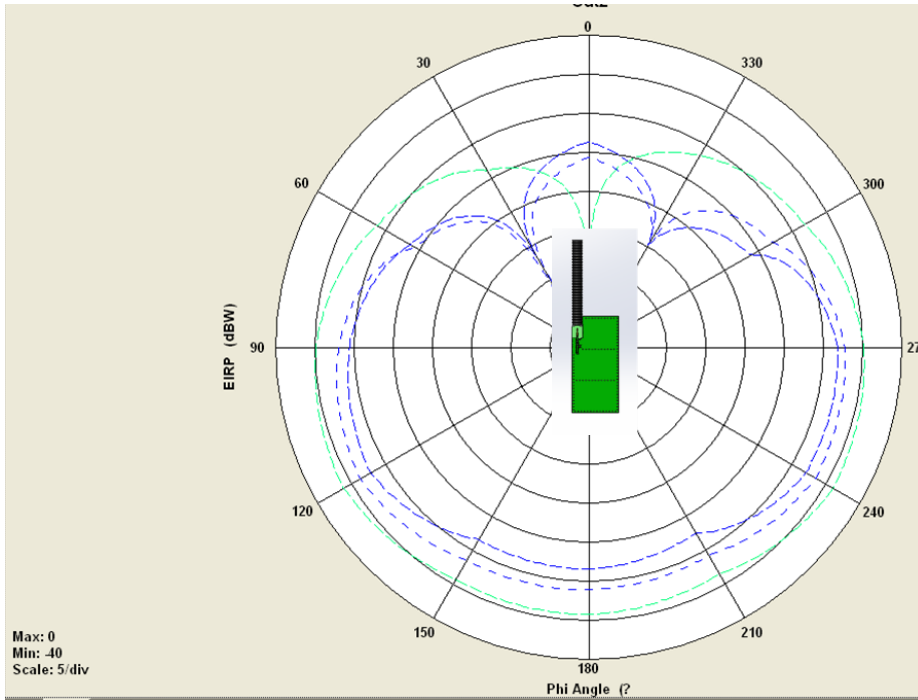

Issue: 1851

In the effort to improve our products, we reserve the right to make changes judged to be necessary.

CONFIDENTIAL AND PROPRIETARY INFORMATION

This document contains confidential and proprietary information of Pulse Electronics, Inc. (Pulse) and is protected by copyright, trade secret and other state and federal laws. Its receipt or possession does not convey any rights to reproduce, disclose its contents, or to manufacture, use or sell anything it may describe. Reproduction, disclosure or use without specific written authorization of Pulse is strictly forbidden.

Series: Helix Coil

Description: ISM 169/433/868/915/2450MHz
Helical Antenna

PART NUMBER: W3100X

CHARTS

W3100A

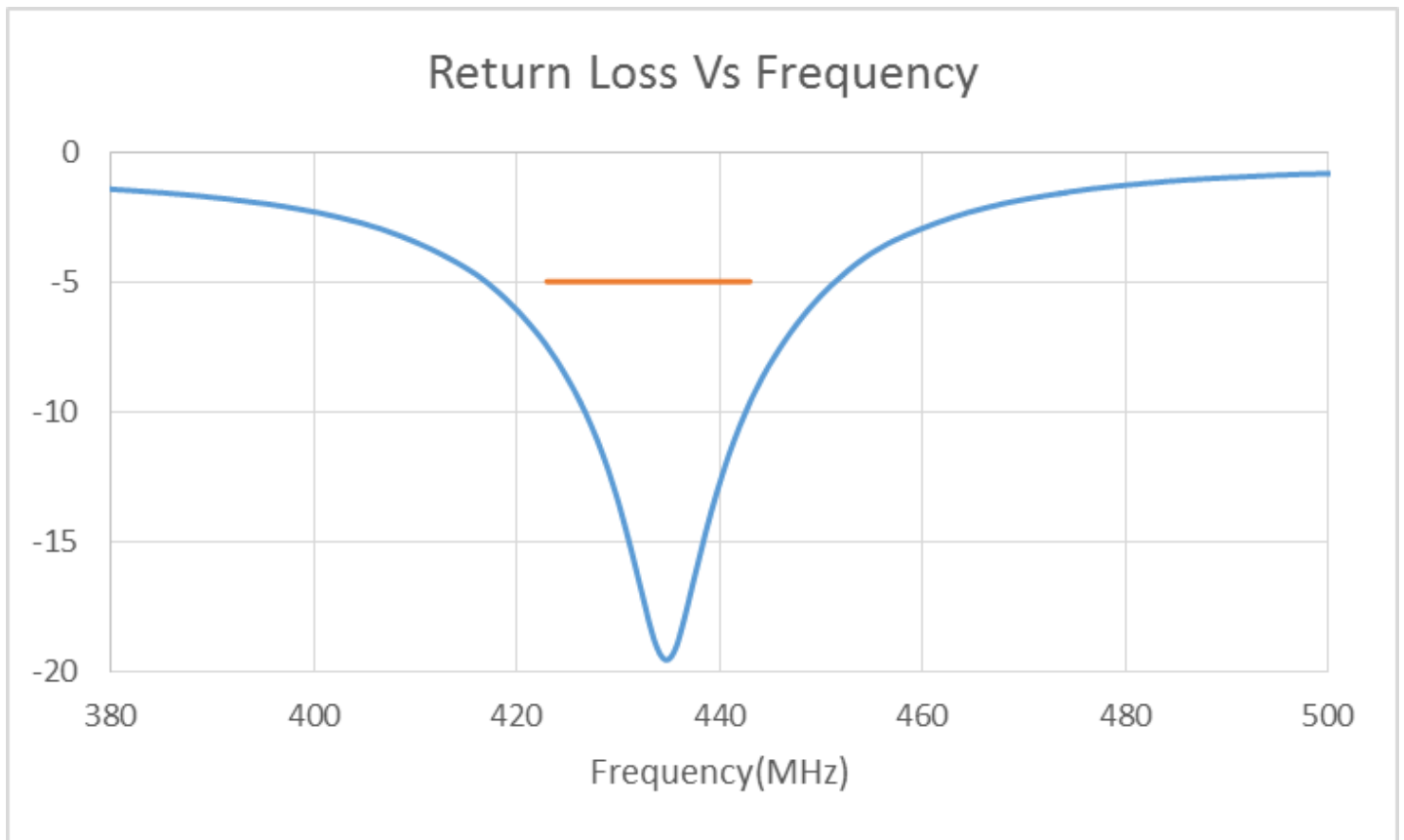

Issue: 1851

In the effort to improve our products, we reserve the right to make changes judged to be necessary.

CONFIDENTIAL AND PROPRIETARY INFORMATION

This document contains confidential and proprietary information of Pulse Electronics, Inc. (Pulse) and is protected by copyright, trade secret and other state and federal laws. Its receipt or possession does not convey any rights to reproduce, disclose its contents, or to manufacture, use or sell anything it may describe. Reproduction, disclosure or use without specific written authorization of Pulse is strictly forbidden.

Series: Helix Coil

Description: ISM 169/433/868/915/2450MHz
Helical Antenna

PART NUMBER: W3100X

CHARTS

W3100A

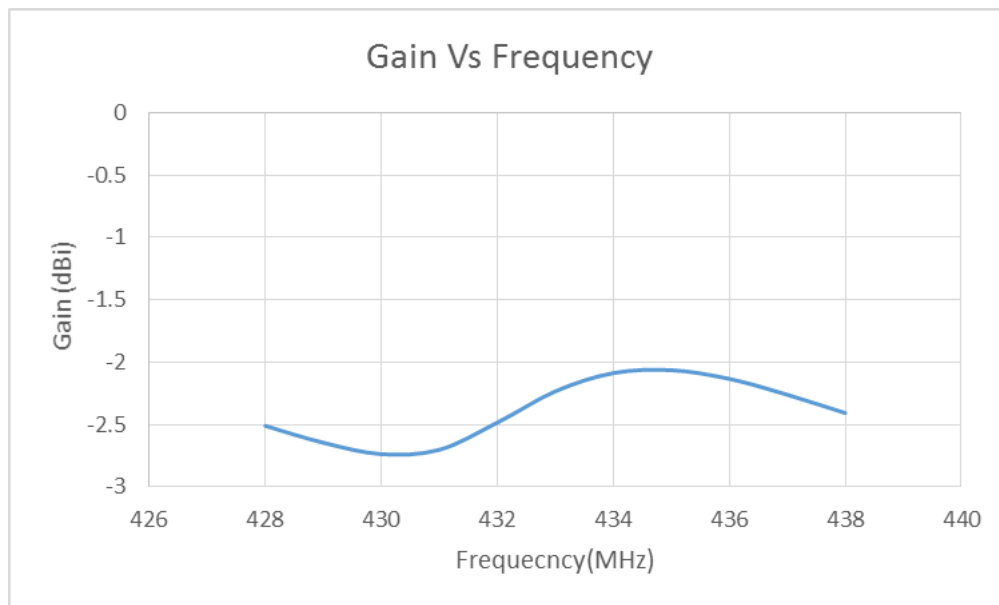
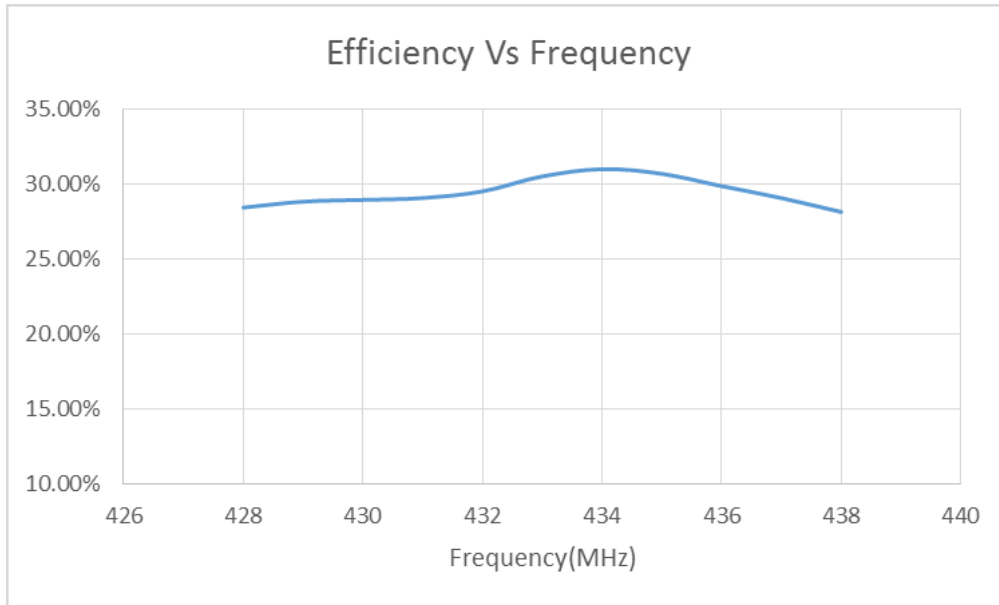

Issue: 1851

In the effort to improve our products, we reserve the right to make changes judged to be necessary.

CONFIDENTIAL AND PROPRIETARY INFORMATION

This document contains confidential and proprietary information of Pulse Electronics, Inc. (Pulse) and is protected by copyright, trade secret and other state and federal laws. Its receipt or possession does not convey any rights to reproduce, disclose its contents, or to manufacture, use or sell anything it may describe. Reproduction, disclosure or use without specific written authorization of Pulse is strictly forbidden.

Series: Helix Coil

Description: ISM 169/433/868/915/2450MHz
Helical Antenna

PART NUMBER: W3100X

CHARTS

W3100A

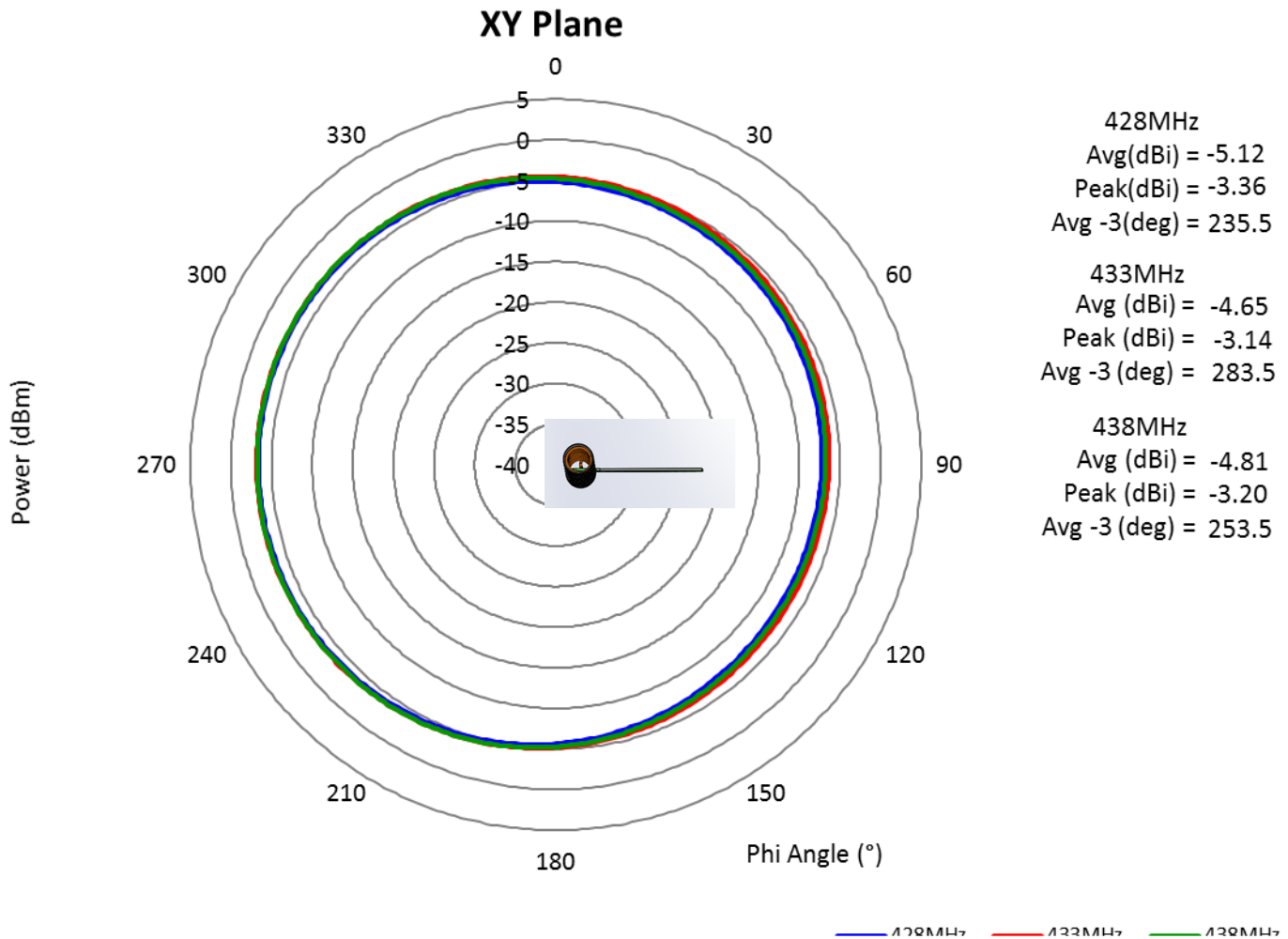

Issue: 1851

In the effort to improve our products, we reserve the right to make changes judged to be necessary.

CONFIDENTIAL AND PROPRIETARY INFORMATION

This document contains confidential and proprietary information of Pulse Electronics, Inc. (Pulse) and is protected by copyright, trade secret and other state and federal laws. Its receipt or possession does not convey any rights to reproduce, disclose its contents, or to manufacture, use or sell anything it may describe. Reproduction, disclosure or use without specific written authorization of Pulse is strictly forbidden.

Description: ISM 169/433/868/915/2450MHz
Helical Antenna

Series: Helix Coil

PART NUMBER: W3100X

CHARTS

W3100A

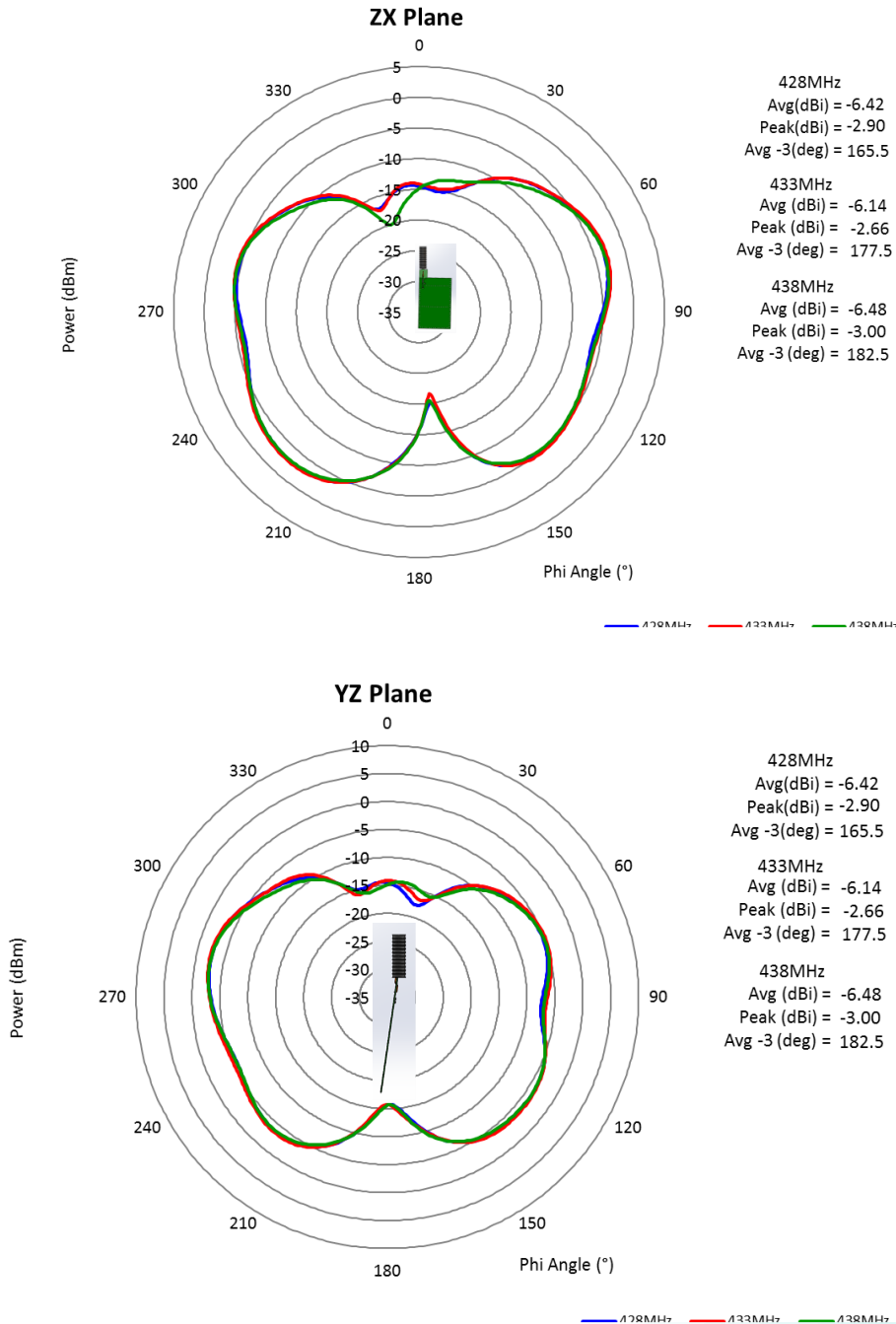

Issue: 1851

In the effort to improve our products, we reserve the right to make changes judged to be necessary.
CONFIDENTIAL AND PROPRIETARY INFORMATION

This document contains confidential and proprietary information of Pulse Electronics, Inc. (Pulse) and is protected by copyright, trade secret and other state and federal laws. Its receipt or possession does not convey any rights to reproduce, disclose its contents, or to manufacture, use or sell anything it may describe. Reproduction, disclosure or use without specific written authorization of Pulse is strictly forbidden.

Series: Helix Coil

Description: ISM 169/433/868/915/2450MHz
Helical Antenna

PART NUMBER: W3100X

CHARTS

W3100B

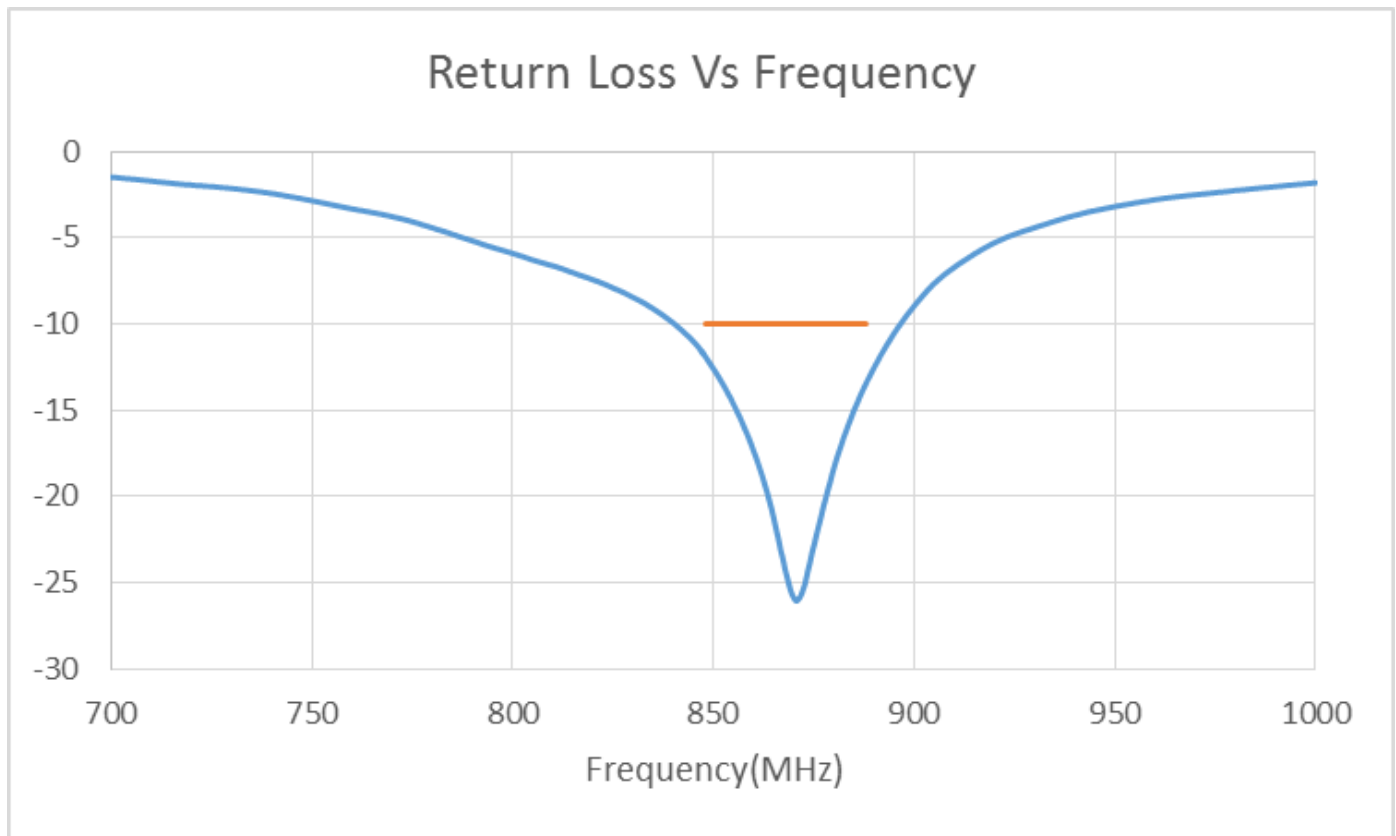

Issue: 1851

In the effort to improve our products, we reserve the right to make changes judged to be necessary.

CONFIDENTIAL AND PROPRIETARY INFORMATION

This document contains confidential and proprietary information of Pulse Electronics, Inc. (Pulse) and is protected by copyright, trade secret and other state and federal laws. Its receipt or possession does not convey any rights to reproduce, disclose its contents, or to manufacture, use or sell anything it may describe. Reproduction, disclosure or use without specific written authorization of Pulse is strictly forbidden.

Description: ISM 169/433/868/915/2450MHz
Helical Antenna

Series: Helix Coil

PART NUMBER: W3100X

CHARTS

W3100B

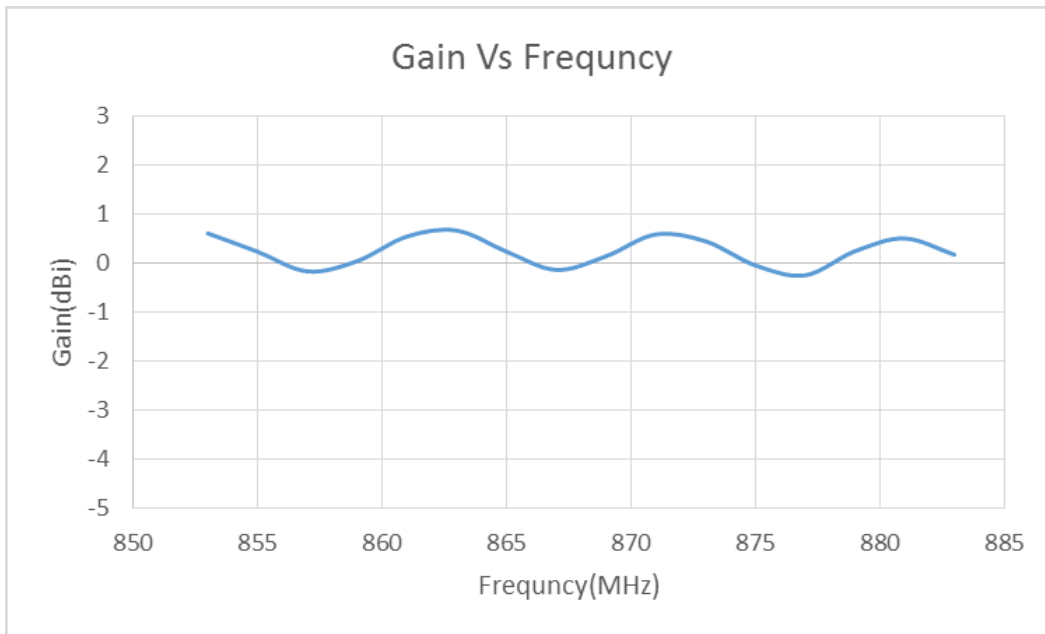
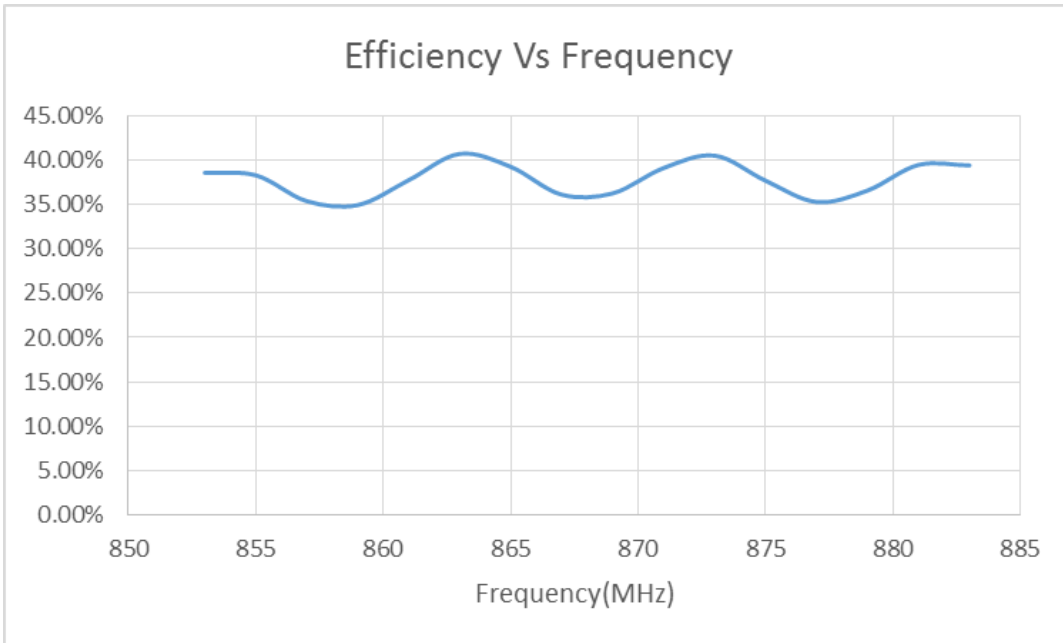

Issue: 1851

In the effort to improve our products, we reserve the right to make changes judged to be necessary.

CONFIDENTIAL AND PROPRIETARY INFORMATION

This document contains confidential and proprietary information of Pulse Electronics, Inc. (Pulse) and is protected by copyright, trade secret and other state and federal laws. Its receipt or possession does not convey any rights to reproduce, disclose its contents, or to manufacture, use or sell anything it may describe. Reproduction, disclosure or use without specific written authorization of Pulse is strictly forbidden.

Description: ISM 169/433/868/915/2450MHz
Helical Antenna

Series: Helix Coil

PART NUMBER: W3100X

CHARTS

W3100B

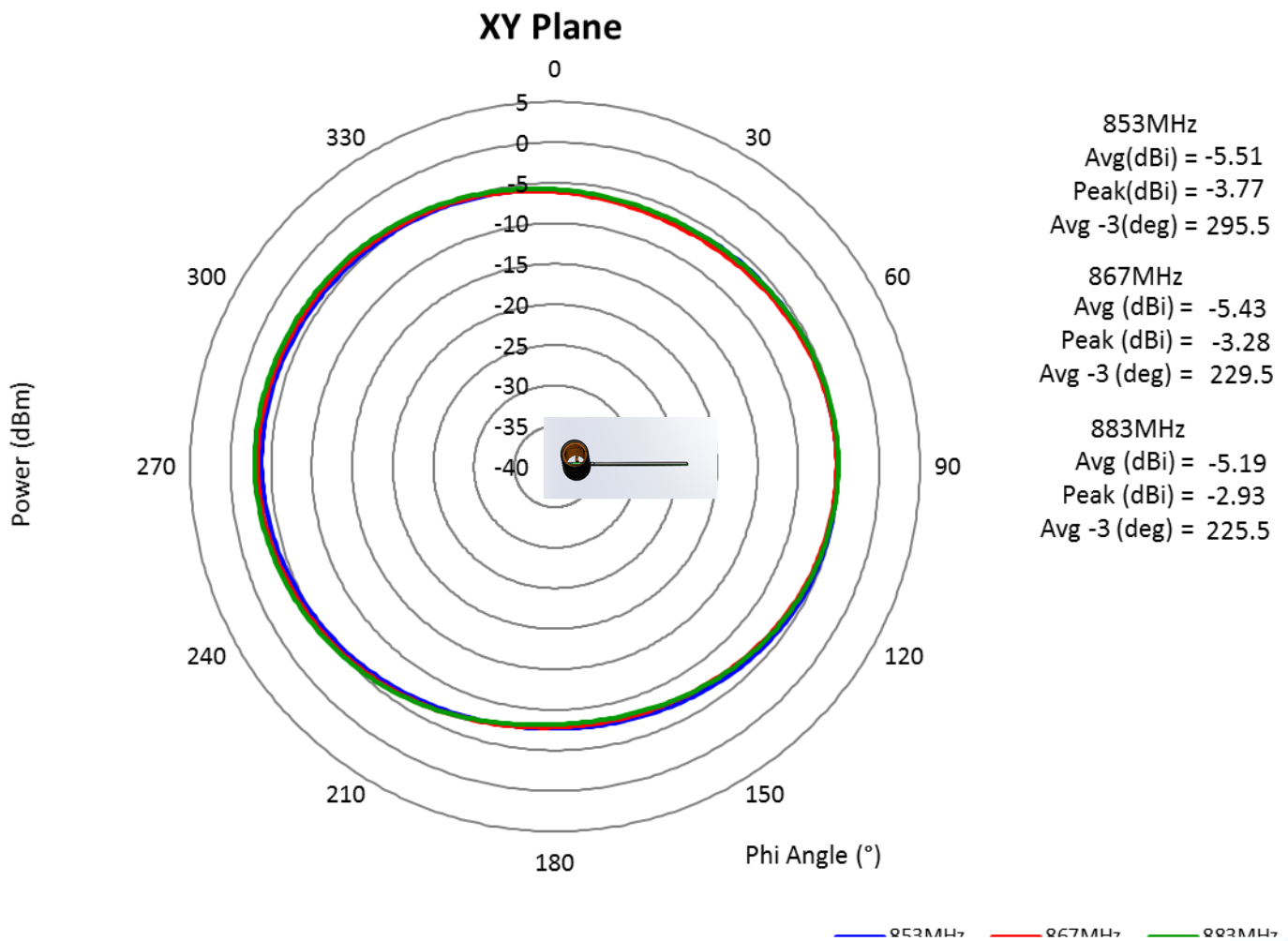

Issue: 1851

In the effort to improve our products, we reserve the right to make changes judged to be necessary.

CONFIDENTIAL AND PROPRIETARY INFORMATION

This document contains confidential and proprietary information of Pulse Electronics, Inc. (Pulse) and is protected by copyright, trade secret and other state and federal laws. Its receipt or possession does not convey any rights to reproduce, disclose its contents, or to manufacture, use or sell anything it may describe. Reproduction, disclosure or use without specific written authorization of Pulse is strictly forbidden.

Description: ISM 169/433/868/915/2450MHz
Helical Antenna

Series: Helix Coil

PART NUMBER: W3100X

CHARTS

W3100B

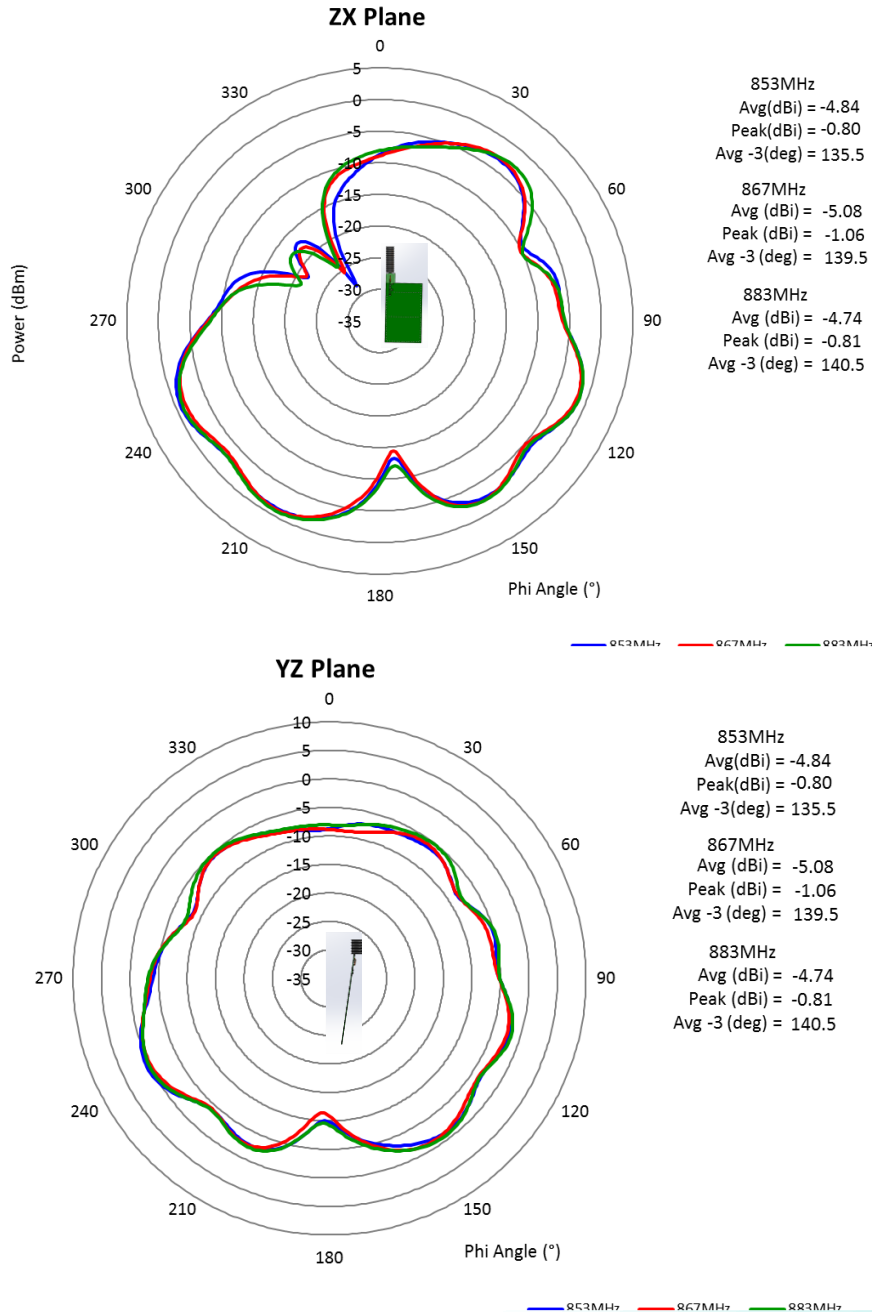

Issue: 1851

In the effort to improve our products, we reserve the right to make changes judged to be necessary.
CONFIDENTIAL AND PROPRIETARY INFORMATION

This document contains confidential and proprietary information of Pulse Electronics, Inc. (Pulse) and is protected by copyright, trade secret and other state and federal laws. Its receipt or possession does not convey any rights to reproduce, disclose its contents, or to manufacture, use or sell anything it may describe. Reproduction, disclosure or use without specific written authorization of Pulse is strictly forbidden.

Series: Helix Coil

Description: ISM 169/433/868/915/2450MHz
Helical Antenna

PART NUMBER: W3100X

CHARTS

W3100C

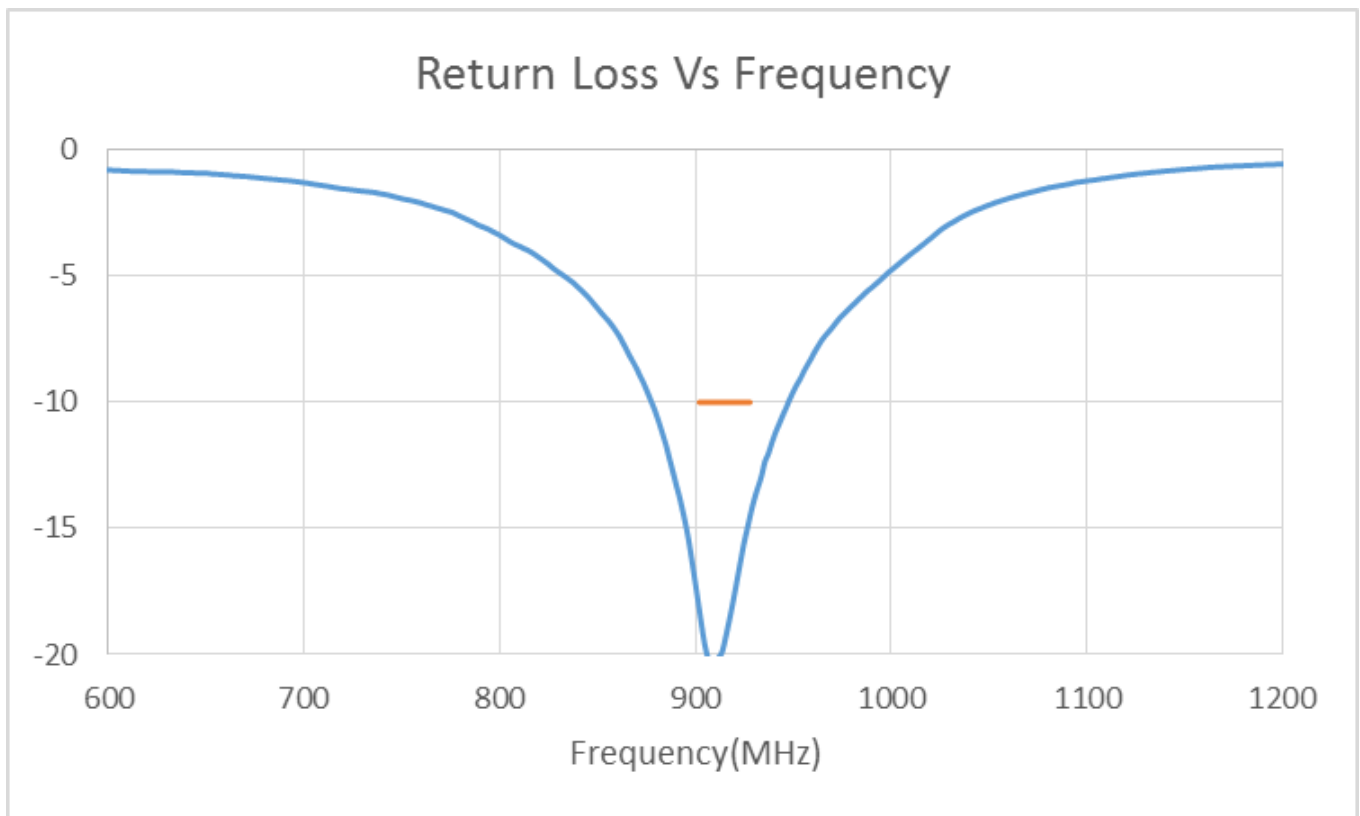

Issue: 1851

In the effort to improve our products, we reserve the right to make changes judged to be necessary.

CONFIDENTIAL AND PROPRIETARY INFORMATION

This document contains confidential and proprietary information of Pulse Electronics, Inc. (Pulse) and is protected by copyright, trade secret and other state and federal laws. Its receipt or possession does not convey any rights to reproduce, disclose its contents, or to manufacture, use or sell anything it may describe. Reproduction, disclosure or use without specific written authorization of Pulse is strictly forbidden.

Description: ISM 169/433/868/915/2450MHz
Helical Antenna

Series: Helix Coil

PART NUMBER: W3100X

CHARTS

W3100C

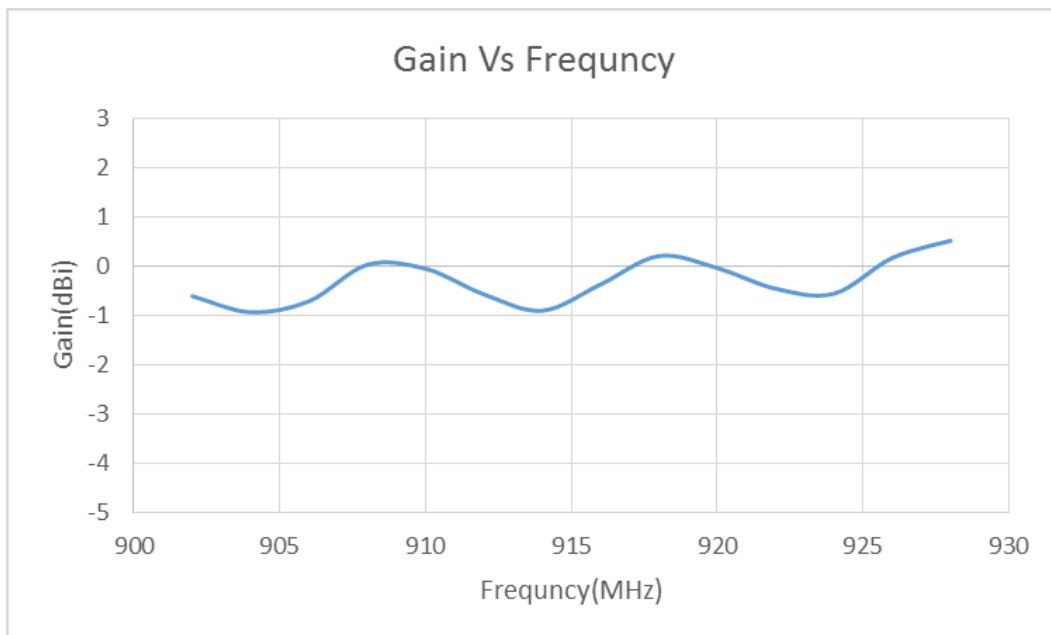
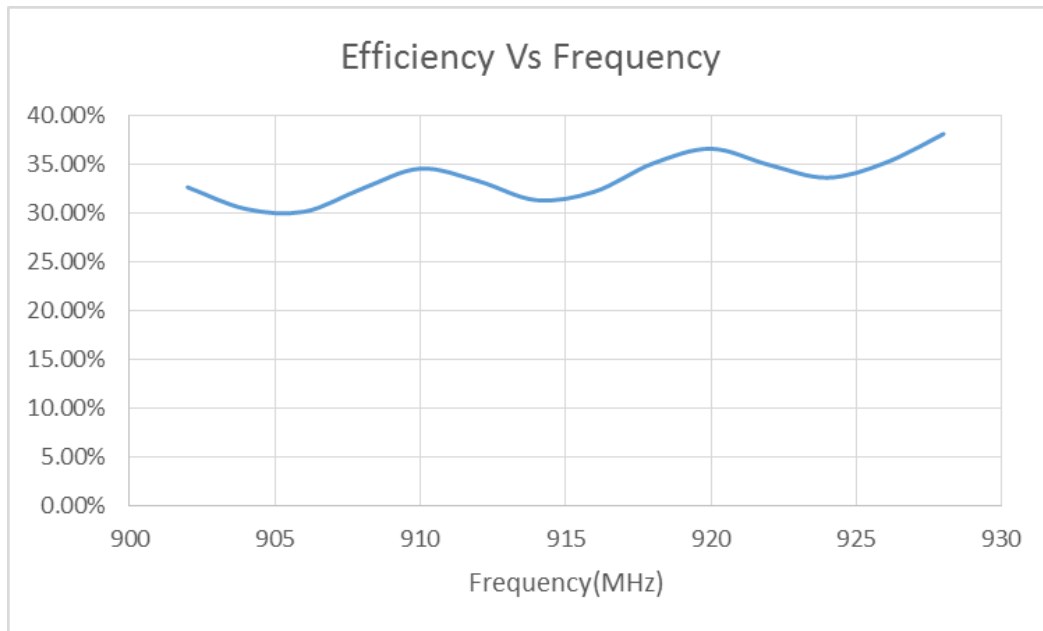

Issue: 1851

In the effort to improve our products, we reserve the right to make changes judged to be necessary.

CONFIDENTIAL AND PROPRIETARY INFORMATION

This document contains confidential and proprietary information of Pulse Electronics, Inc. (Pulse) and is protected by copyright, trade secret and other state and federal laws. Its receipt or possession does not convey any rights to reproduce, disclose its contents, or to manufacture, use or sell anything it may describe. Reproduction, disclosure or use without specific written authorization of Pulse is strictly forbidden.

Series: Helix Coil

Description: ISM 169/433/868/915/2450MHz
Helical Antenna

PART NUMBER: W3100X

CHARTS

W3100C

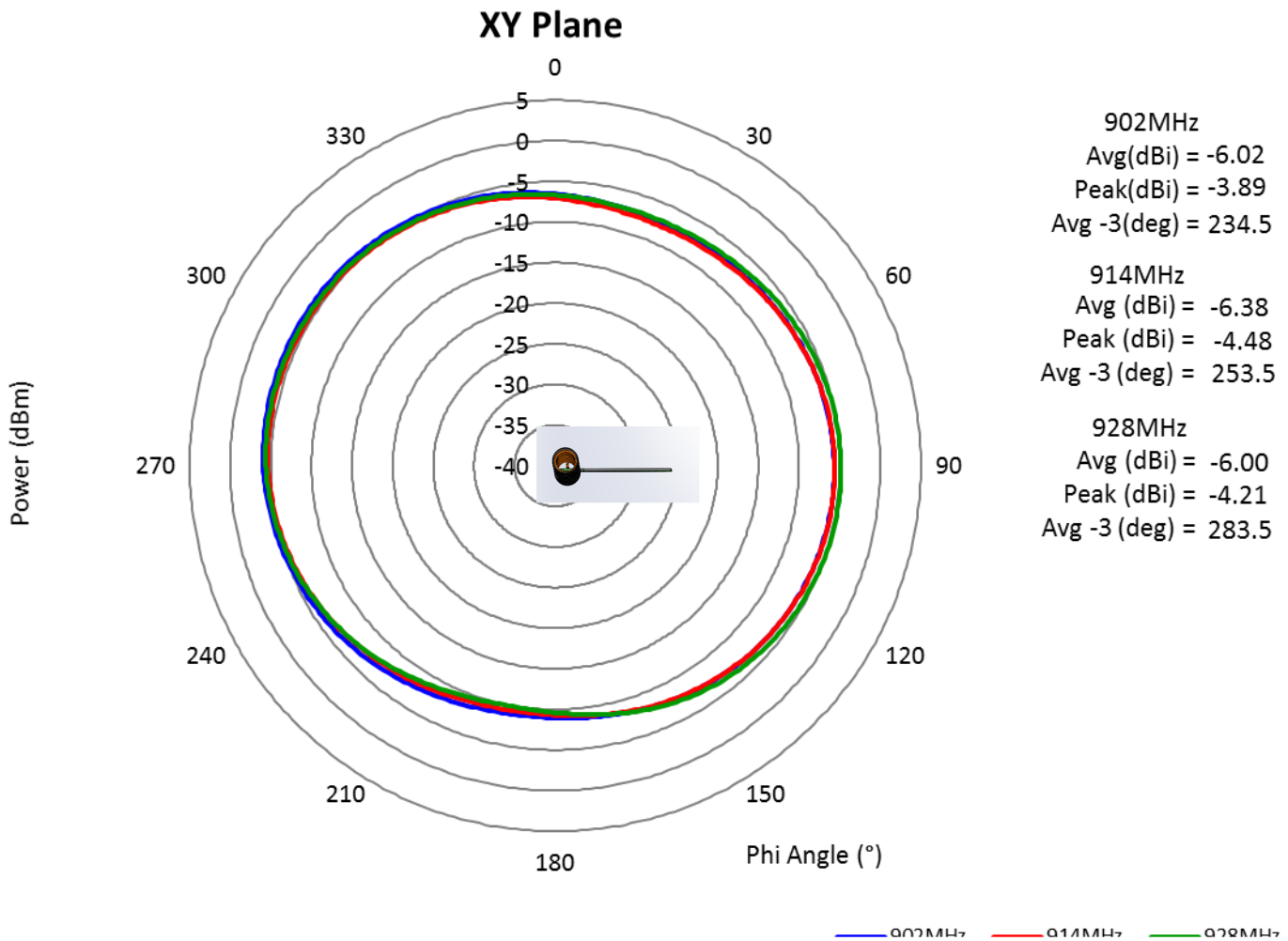

Issue: 1851

In the effort to improve our products, we reserve the right to make changes judged to be necessary.

CONFIDENTIAL AND PROPRIETARY INFORMATION

This document contains confidential and proprietary information of Pulse Electronics, Inc. (Pulse) and is protected by copyright, trade secret and other state and federal laws. Its receipt or possession does not convey any rights to reproduce, disclose its contents, or to manufacture, use or sell anything it may describe. Reproduction, disclosure or use without specific written authorization of Pulse is strictly forbidden.

Description: ISM 169/433/868/915/2450MHz
Helical Antenna

Series: Helix Coil

PART NUMBER: W3100X

CHARTS

W3100C

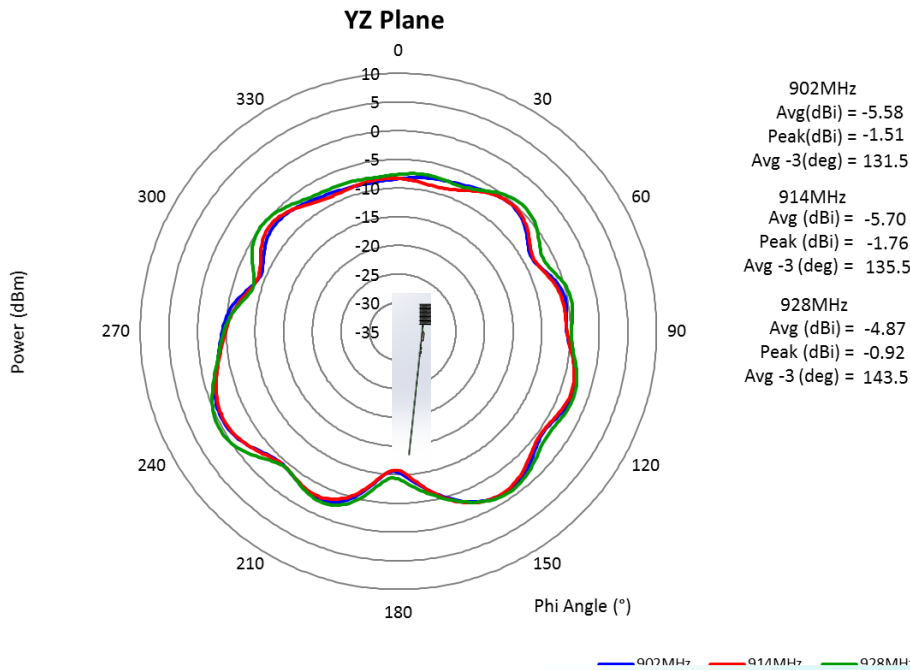
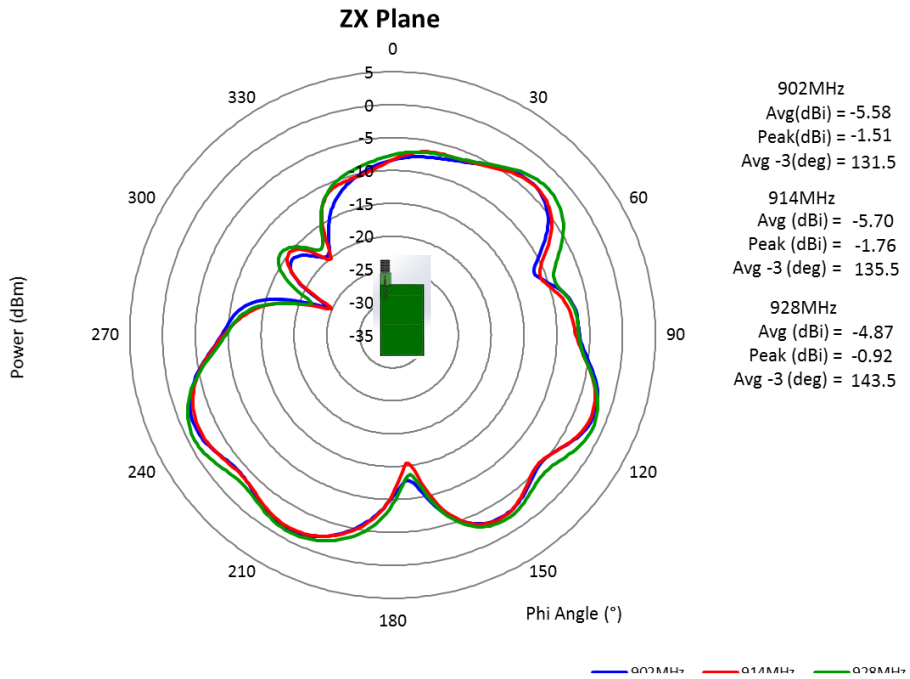

Issue: 1851

In the effort to improve our products, we reserve the right to make changes judged to be necessary.

CONFIDENTIAL AND PROPRIETARY INFORMATION

This document contains confidential and proprietary information of Pulse Electronics, Inc. (Pulse) and is protected by copyright, trade secret and other state and federal laws. Its receipt or possession does not convey any rights to reproduce, disclose its contents, or to manufacture, use or sell anything it may describe. Reproduction, disclosure or use without specific written authorization of Pulse is strictly forbidden.

Series: Helix Coil

Description: ISM 169/433/868/915/2450MHz
Helical Antenna

PART NUMBER: W3100X

CHARTS

W3100D

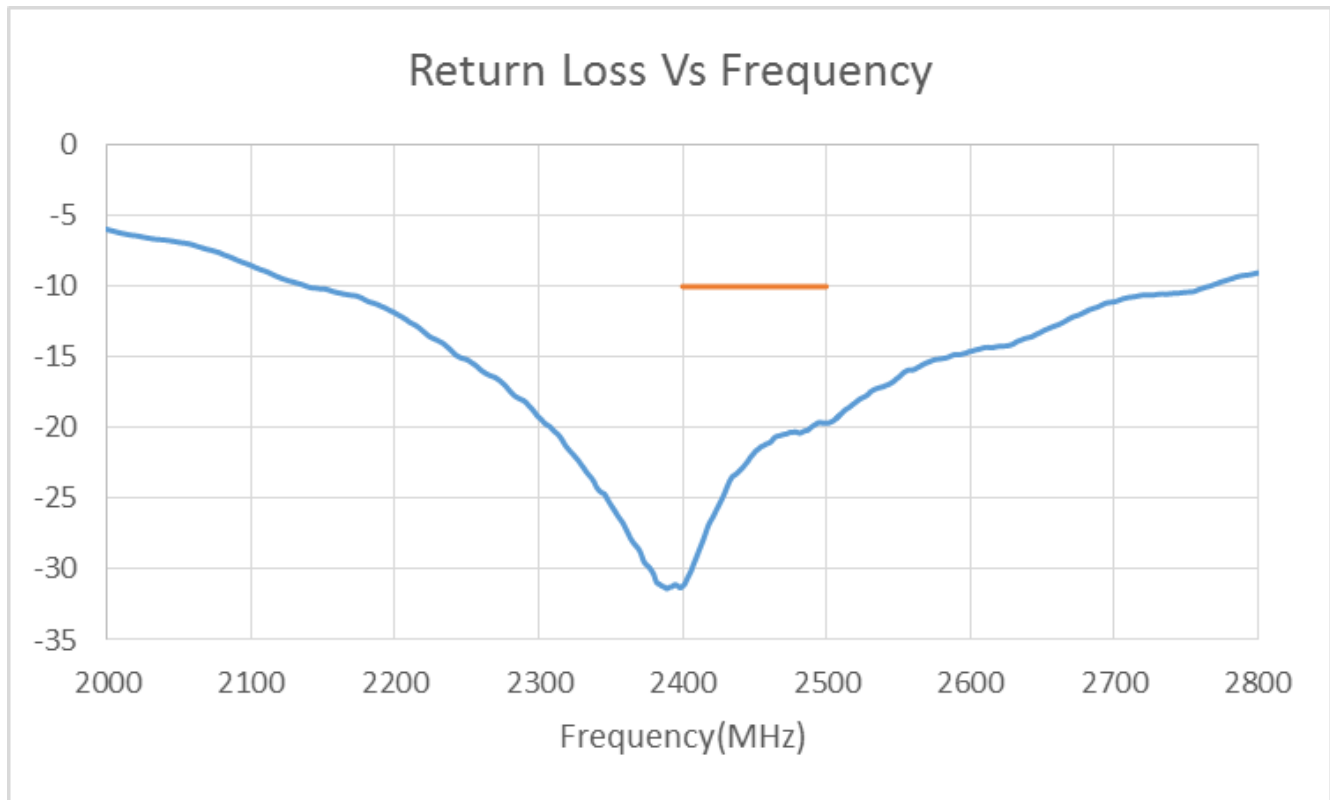

Issue: 1851

In the effort to improve our products, we reserve the right to make changes judged to be necessary.

CONFIDENTIAL AND PROPRIETARY INFORMATION

This document contains confidential and proprietary information of Pulse Electronics, Inc. (Pulse) and is protected by copyright, trade secret and other state and federal laws. Its receipt or possession does not convey any rights to reproduce, disclose its contents, or to manufacture, use or sell anything it may describe. Reproduction, disclosure or use without specific written authorization of Pulse is strictly forbidden.

Description: ISM 169/433/868/915/2450MHz
Helical Antenna

Series: Helix Coil

PART NUMBER: W3100X

CHARTS

W3100D

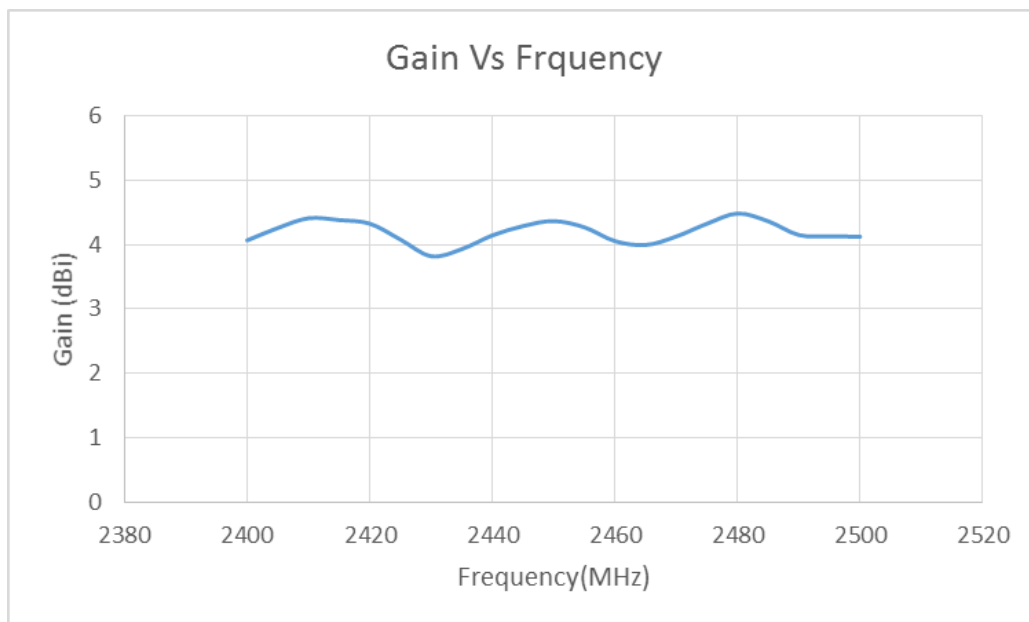
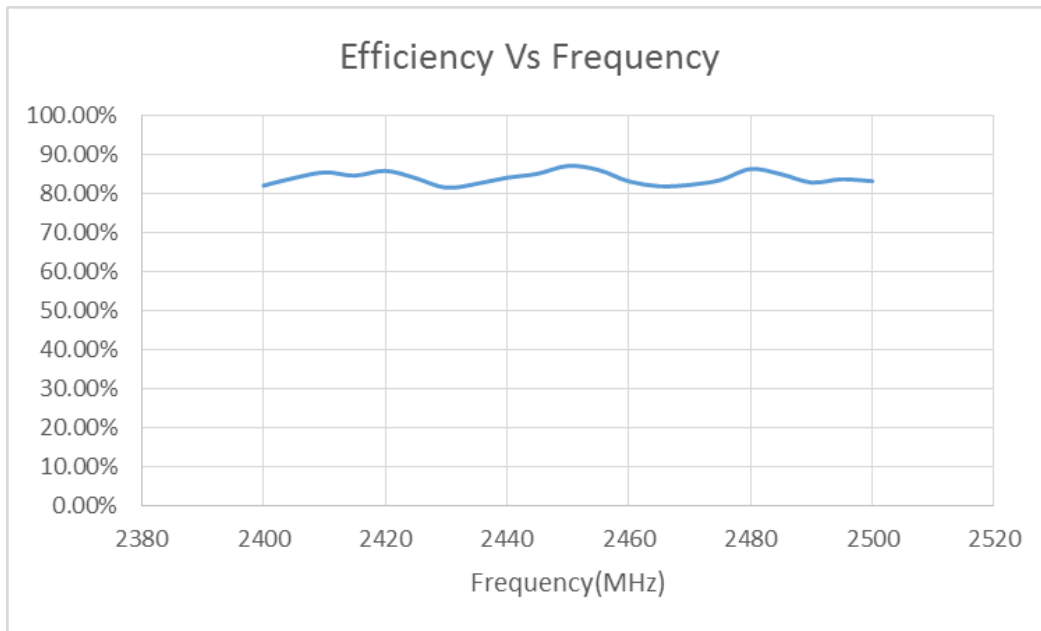

Issue: 1851

In the effort to improve our products, we reserve the right to make changes judged to be necessary.

CONFIDENTIAL AND PROPRIETARY INFORMATION

This document contains confidential and proprietary information of Pulse Electronics, Inc. (Pulse) and is protected by copyright, trade secret and other state and federal laws. Its receipt or possession does not convey any rights to reproduce, disclose its contents, or to manufacture, use or sell anything it may describe. Reproduction, disclosure or use without specific written authorization of Pulse is strictly forbidden.

Series: Helix Coil

Description: ISM 169/433/868/915/2450MHz
Helical Antenna

PART NUMBER: W3100X

CHARTS

W3100D

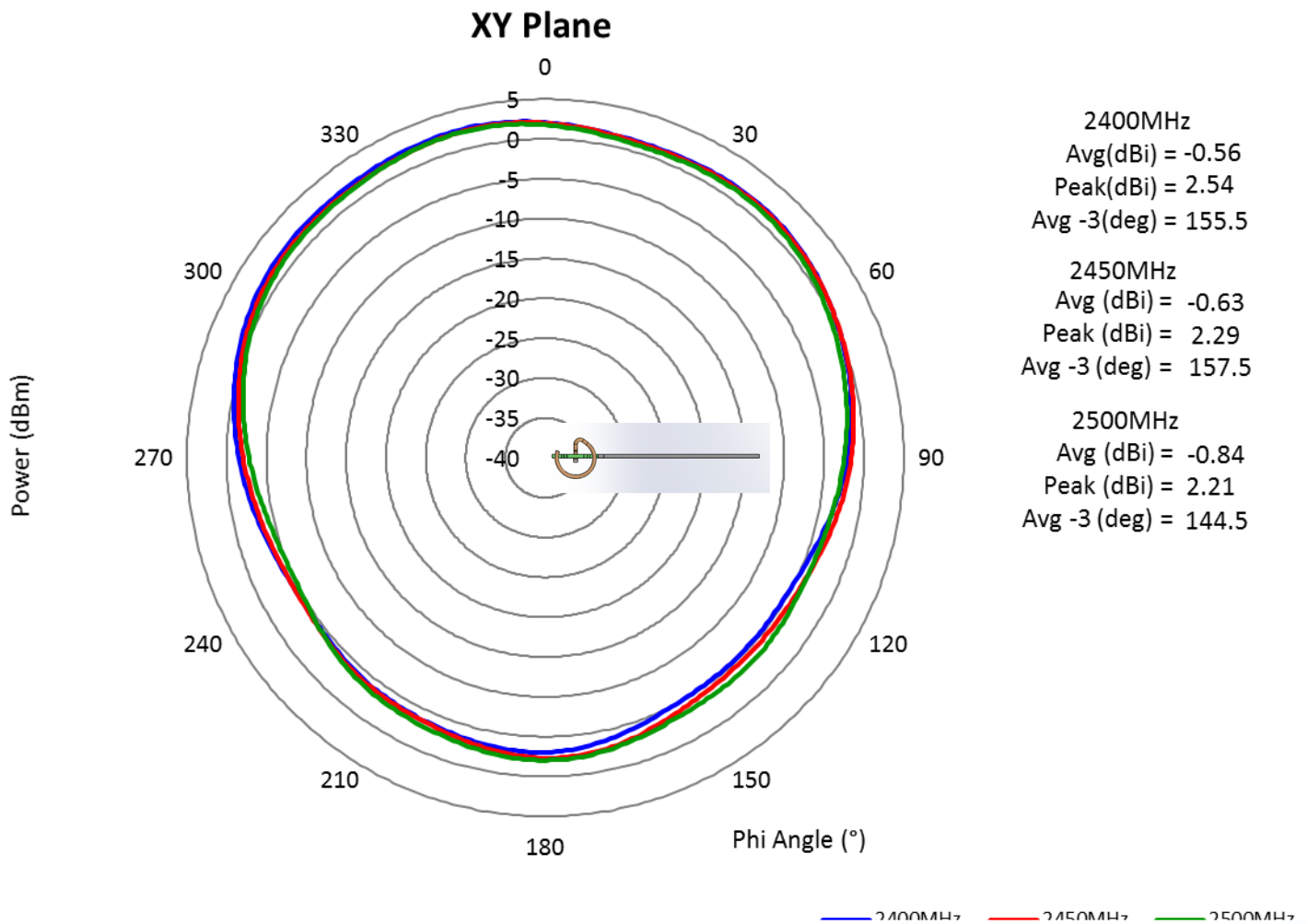

Issue: 1851

In the effort to improve our products, we reserve the right to make changes judged to be necessary.

CONFIDENTIAL AND PROPRIETARY INFORMATION

This document contains confidential and proprietary information of Pulse Electronics, Inc. (Pulse) and is protected by copyright, trade secret and other state and federal laws. Its receipt or possession does not convey any rights to reproduce, disclose its contents, or to manufacture, use or sell anything it may describe. Reproduction, disclosure or use without specific written authorization of Pulse is strictly forbidden.

Description: ISM 169/433/868/915/2450MHz
Helical Antenna

Series: Helix Coil

PART NUMBER: W3100X

CHARTS

W3100D

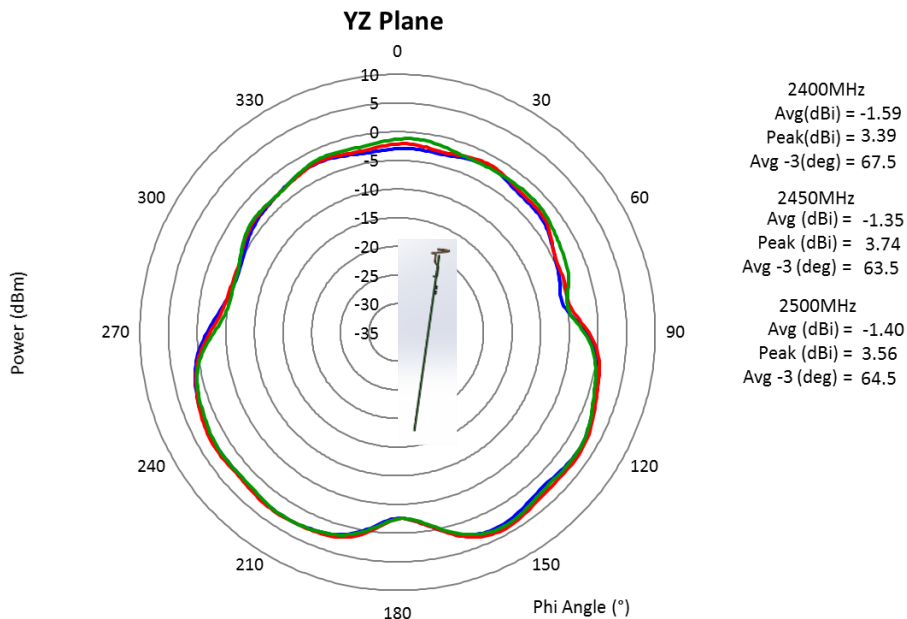
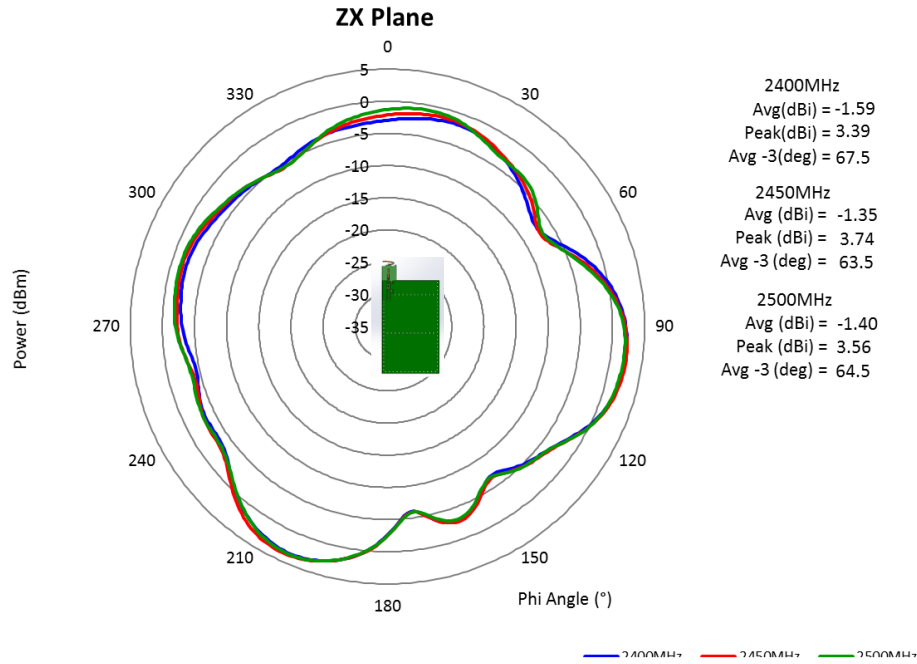

Issue: 1851

In the effort to improve our products, we reserve the right to make changes judged to be necessary.

CONFIDENTIAL AND PROPRIETARY INFORMATION

This document contains confidential and proprietary information of Pulse Electronics, Inc. (Pulse) and is protected by copyright, trade secret and other state and federal laws. Its receipt or possession does not convey any rights to reproduce, disclose its contents, or to manufacture, use or sell anything it may describe. Reproduction, disclosure or use without specific written authorization of Pulse is strictly forbidden.