

# Mini Wideband Transformers – WBC

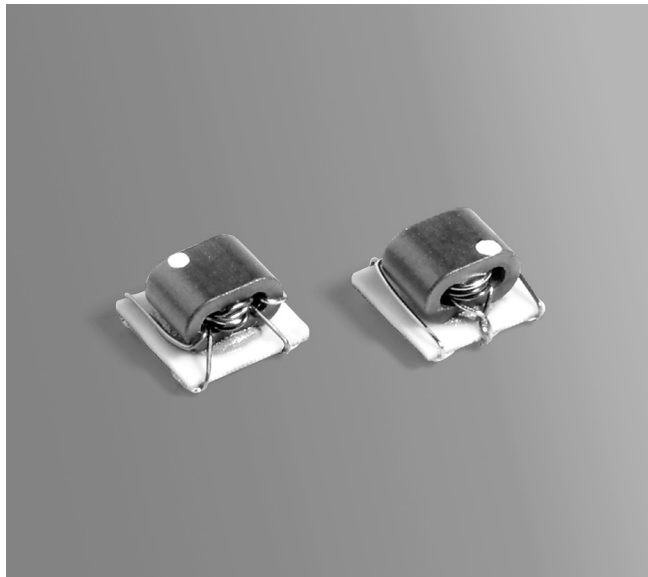

- Smallest wideband transformer: 4 mm square 3 mm high
- 300 Vrms interwinding isolation, 1/4 Watt RF input power
- 250 mA max current rating.
- AEC-Q200 Grade 3 qualified (–40°C to +85°C ambient)

**Designer's Kit C393** contains three of each part

**Core material** Ferrite

**Terminations** RoHS compliant tin-silver-copper over silver-platinum-glass frit. Other terminations available at additional cost.

**Weight** 68.0 – 88.8 mg

**Ambient temperature** –40°C to +85°C

**Storage temperature** Component: –40°C to +85°C.

Tape and reel packaging: –40°C to +80°C

**Resistance to soldering heat** Max three 40 second reflows at +260°C, parts cooled to room temperature between cycles

**Moisture Sensitivity Level (MSL)** 1 (unlimited floor life at <30°C / 85% relative humidity)

**Failures in Time (FIT) / Mean Time Between Failures (MTBF)**

60 per billion hours / 16,666,667 hours, calculated per Telcordia SR-332

**Packaging** 750/7" reel; 2500/13" reel Plastic tape: 12 mm wide, 0.3 mm thick, 8 mm pocket spacing, 2.9 mm pocket depth

**PCB washing** Tested to MIL-STD-202 Method 215 plus an additional aqueous wash. See [Doc787\\_PCBt\\_Washing.pdf](#).

Part number <sup>1</sup>	Schematic	Impedance ratio <sup>2</sup> pri:sec	Bandwidth (MHz)	Insertion loss max (dB)	Pins 4–6 (primary)		Pins 1–3 (secondary)		DC imbalance <sup>5</sup> max (mA)	Color dot
					L min <sup>3</sup> (μH)	DCR max <sup>4</sup> (mOhm)	L min <sup>3</sup> (μH)	DCR max <sup>4</sup> (mOhm)		
WBC1-1L_	A	1:1	0.400–600	0.40	10	120	10	120	—	Brown
WBC1-1TL_	B	1:1	0.250–750	0.58	9.5	75	9.5	75	36	Brown
WBC2-1TL_	B	1:2	0.200–500	0.50	10	120	20	150	8.5	Red
WBC3-1TL_	B	1:3	0.300–900	0.60	9	100	27	150	8.5	Orange
WBC4-1TL_	B	1:4	0.250–750	1.0	9	55	36	120	30	Yellow
WBC4-14L_	B	1:4	1.500–1200	2.0	2	50	8	100	15	Green
WBC4-1WL_	B	1:4	0.500–1000	0.90	5	80	20	120	10	White
WBC4-6TL_	B	1:4	0.300–700	0.65	9	80	36	200	7.5	Blue
WBC8-1L_	D	1:8	0.150–600	0.60	22	120	176	310	17	Gray
WBC9-1L_	B	1:9	0.300–500	0.54	9	80	81	230	5	White
WBC16-1TL_	B	1:16	0.600–300	0.80	5	80	80	230	5	Violet
WBC4-4L_	C	1:4	0.250–800	1.0	9	60	36	120	30	Yellow

1. When ordering, please specify **termination** and **packaging** codes:

WBC4-4LC

**Termination: L** = RoHS compliant tin-silver-copper (95.5/4/0.5) over silver-platinum-glass frit.

Special order: **S** = non-RoHS tin-lead (63/37).

**Packaging: C** = 7" machine-ready reel. EIA-481 embossed plastic tape (750 parts per full reel).

**B** = Less than full reel. In tape, but not machine ready. To have a leader and trailer added (\$25 charge), use code letter C instead.

**D** = 13" machine-ready reel. EIA-481 embossed plastic tape. Factory order only, not stocked (2500 parts per full reel).

2. Impedance ratio is for the full primary winding to the full secondary winding.

3. Inductance measured at 100 kHz, 0.1 V, 0 Adc on an Agilent/HP 4192 or equivalent.

4. DCR measured on a micro-ohmmeter.

5. DC imbalance is the maximum difference in current measured at pins 1 and 3 with the source at pin 2. Inductance drop is 15% at maximum imbalance.

6. Electrical specifications at 25°C. Measurements are referenced to 50 Ohms.

Refer to Doc 362 "Soldering Surface Mount Components" before soldering.

## Schematics

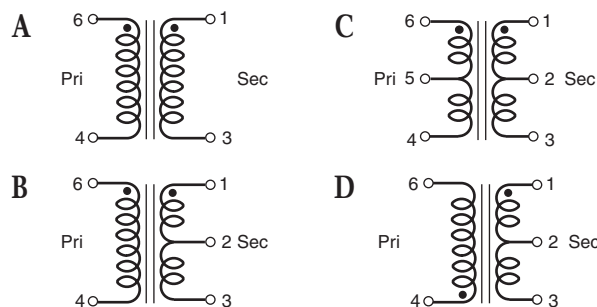



# WBC Series SMT Mini Wideband Transformers

## Dimensions

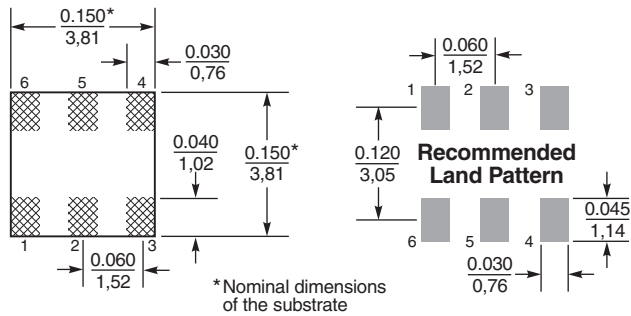
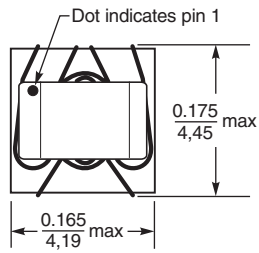

Dimensions are in  $\frac{\text{inches}}{\text{mm}}$



# WBC Series SMT Mini Wideband Transformers

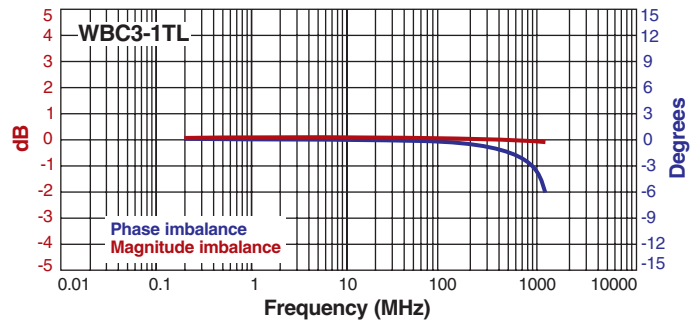
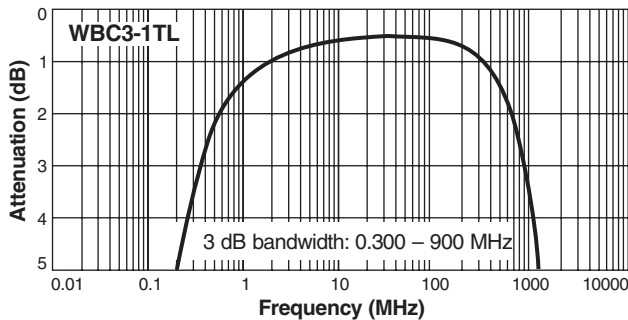
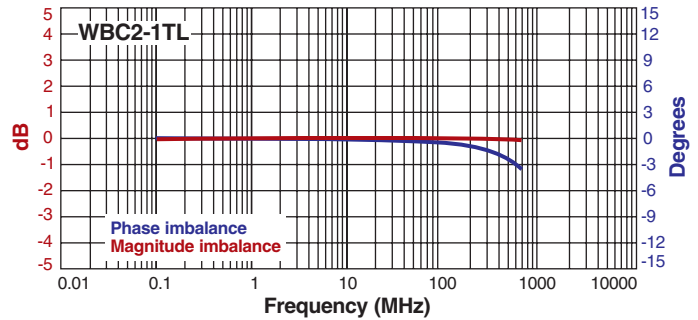
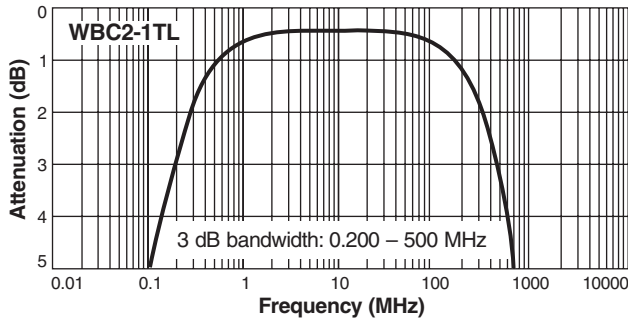
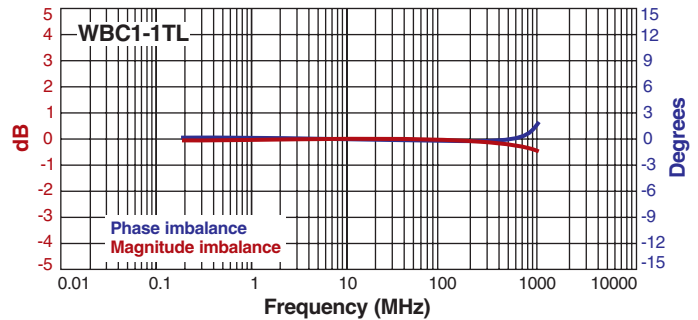
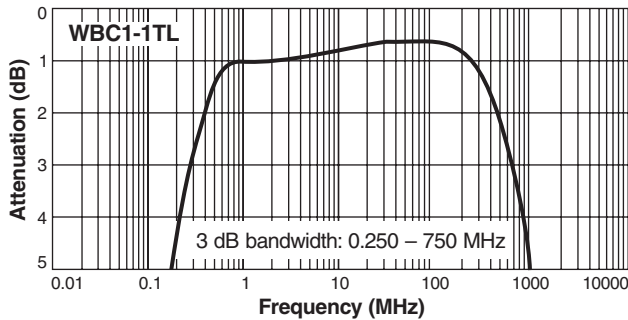
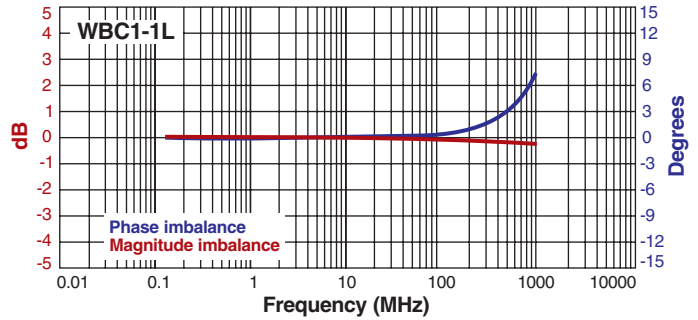
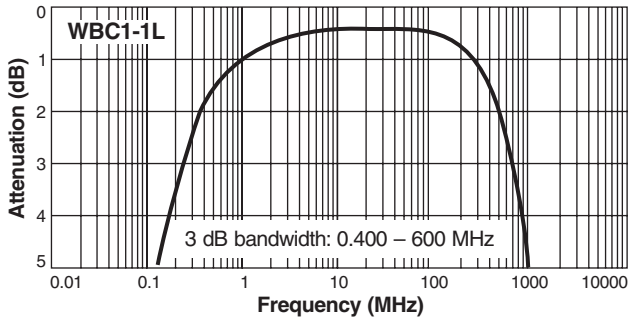

Attenuation measured on a network analyzer (re: 50 Ohms)



**US** +1-847-639-6400 sales@coilcraft.com  
**UK** +44-1236-730595 sales@coilcraft-europe.com  
**Taiwan** +886-2-2264 3646 sales@coilcraft.com.tw  
**China** +86-21-6218 8074 sales@coilcraft.com.cn  
**Singapore** + 65-6484 8412 sales@coilcraft.com.sg

Document 424-3 Revised 01/14/19

© Coilcraft Inc. 2019  
 This product may not be used in medical or high risk applications without prior Coilcraft approval. Specification subject to change without notice. Please check web site for latest information.



# WBC Series SMT Mini Wideband Transformers

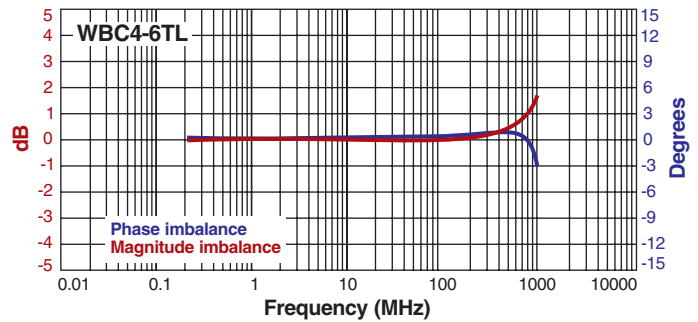
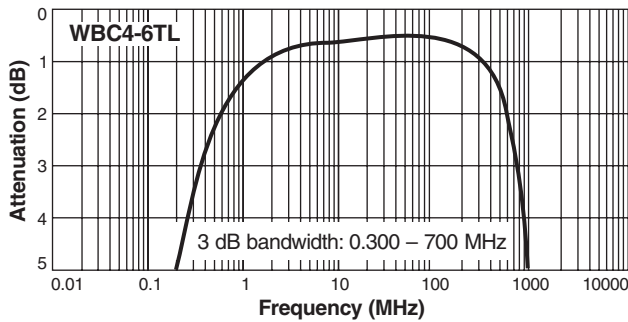
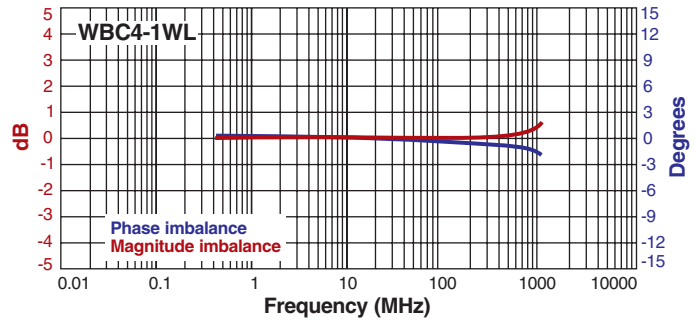
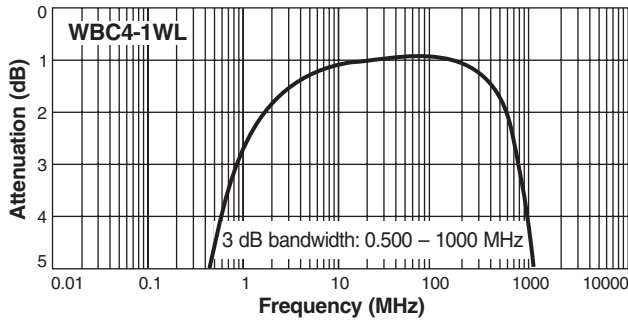
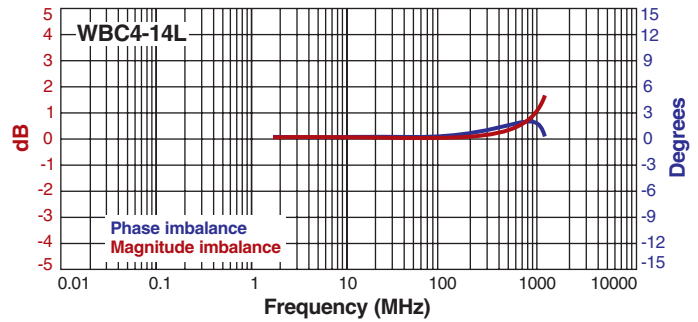
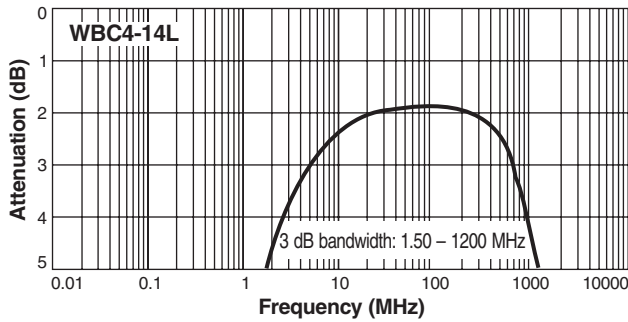
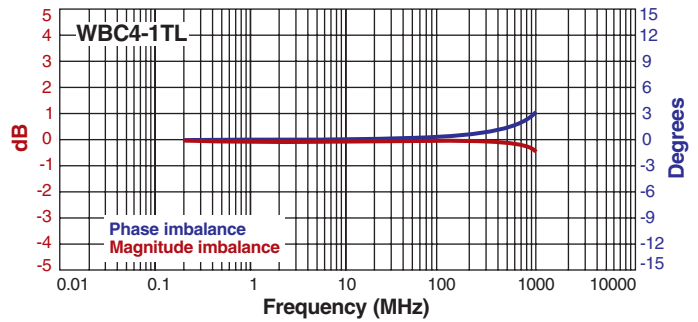
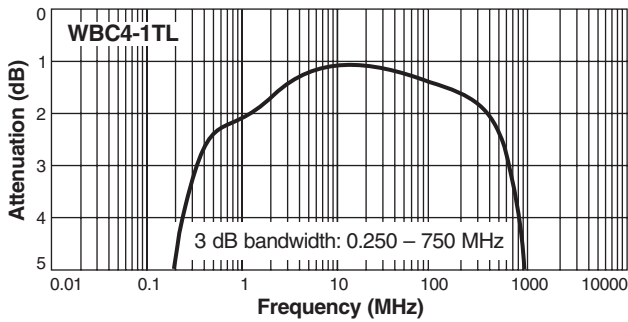

Attenuation measured on a network analyzer (re: 50 Ohms)



**US** +1-847-639-6400 sales@coilcraft.com  
**UK** +44-1236-730595 sales@coilcraft-europe.com  
**Taiwan** +886-2-2264 3646 sales@coilcraft.com.tw  
**China** +86-21-6218 8074 sales@coilcraft.com.cn  
**Singapore** + 65-6484 8412 sales@coilcraft.com.sg

Document 424-4 Revised 01/14/19

© Coilcraft Inc. 2019  
 This product may not be used in medical or high risk applications without prior Coilcraft approval. Specification subject to change without notice. Please check web site for latest information.