

WISE-4471

Cat. NB1/ Cat. M1 Wireless I/O Module

NEW



Introduction

NB-IoT and LTE Cat M1 are new wireless technologies included in the 5G evolution of cellular technology standards defined by the 3rd Generation Partnership Project (3GPP). NB-IoT and LTE Cat M1 feature low power consumption and utilize LTE networks based on licensed spectrum bands. These technologies are optimized for connectivity to machines, assets and sensors in order to enable IoT applications such as smart cities, smart agriculture and remote asset management.

WISE-4471 series is a 4G cellular based IoT wireless sensor node compliant with LTE Cat. NB1 and Cat. M1 with built in antenna for flexible installation. In addition to offering various I/O types, WISE-4471 series provides a data logger and direct cloud connectivity so that data can be published to the cloud by messaging protocol such as MQTT, CoAP, LwM2M with secure socket supported.

Features

Automatic Connection with Cloud

By utilizing leading IoT messaging protocols such as MQTT and CoAP, WISE-4471 series easily integrates with popular cloud services, reducing setup complexity and accelerating implementation.

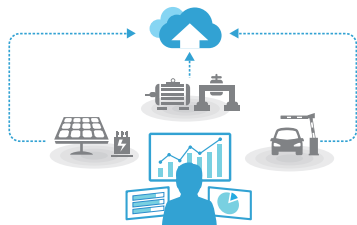

Open Connectivity for Cloud and System

WISE-4471 series support CoAP and MQTT communication protocols while continually integrating mainstream cloud services to simplify the complexity of data integration.

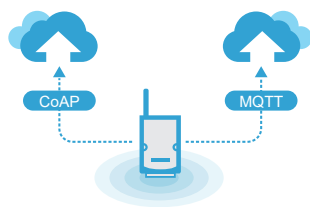

Features

- Global coverage of Cat. NB1 and Cat. M1 frequency bands
- Application-ready I/O combination with optional IP65 I/O
- Wide voltage power input with 10 ~ 50V_{DC}
- Data buffered function with time stamp reducing data lost
- Fast and easy deployment to reduce operation cost
- Supports direct cloud service for IoT integration
- Support MQTT, CoAP & LwM2M protocol

Legacy and Existing Devices to NB-IoT/eMTC

WISE-4471 series offer digital I/O, 4~20-mA analog and RS-232/485 interfaces for various applications, quickly providing NB-IoT/eMTC network functions to existing devices and assets.

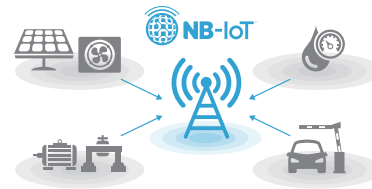

Upgrade Legacy Equipment through Cloud Management

WISE-4471 series NB-IoT/eMTC sensor nodes are suitable for data collection from widely distributed assets. No complicated programming, setup, or registration are required for a fast introduction into IoT applications such as smart cities, smart water/electricity meters, and remote facility management.

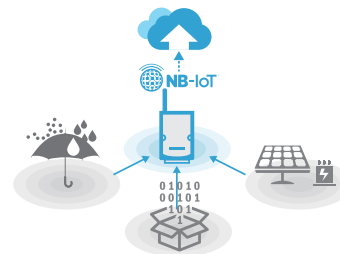

Device to Cloud System Architecture

WISE-4471 series wireless sensor nodes support the open communication protocols MQTT, CoAP, and LwM2M. Users can transmit data to specific public cloud services or existing private cloud platforms by publish/subscribe or push.

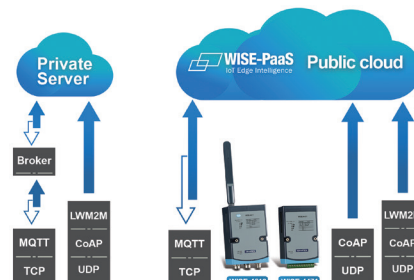

Specification

Wireless Communication

- 3GPP Standards R, 13, Cat. NB1/ Cat. M1
- Frequency Band 2, 3, 4, 5, 8, 12, 13, 20, 28
- Antenna Type Internal

General

- Power Input 10 ~ 50V_{DC} external power
- Power Consumption 2.0 W
- Configuration Interface Micro-B USB
- SIM 3FF/Micro SIM
- Connector WISE-4471-S2xxx Plug-in screw terminal block (I/O and power)
WISE-4471-S4xxx M12 4-pin code-A male x 1 (Power)
M12 8-pin code-D female x 1 (I/O)
- LED Indicator Status, Error, Tx, Rx, Signal Level
- Mounting DIN 35 rail, wall, pole and stack
- Dimension (W x H x D) 70 x 112 x 38 mm
- Certification CE, NCC, FCC, IC

WISE-S214 (4AI/4DI)

Analog Input

- Channels 4
- Resolution 16bits Bipolar; 15bits Unipolar
- Sampling Rate 10Hz (Total) with 50/60Hz Rejection
- Accuracy ±0.1% for Voltage Input; ±0.2% for Current Input
- Input Range 0~150mV, 0~500mV, 0~1V, 0~5V, 0~10V, ±150mV, ±500mV, ±1V, ±5V, ±10V, 0~20mA, ±20mA, 4~20mA
>1MΩ (Voltage)
- Input Impedance 240 Ω (External resistor for current)
- Support Data Scaling and Averaging

Digital Input

- Channels 4 (Dry Contact)
- Supports 200Hz Counter Input (32-bit + 1-bit overflow)
- Supports keep/discard counter value on power-off
- Support inverted digital input status

WISE-S250 (6DI, 2DO & 1RS-485)

Digital Input

- Channels 6 (Dry Contact)
- Supports 3kHz Frequency Input

Digital Output (Sink Type)

- Channel 2
- Output Current 100 mA
At 0 → 1: 100 us
At 1 → 0: 100 us
(for Resistive Load)
- Supports Pules Output 5 kHz
- Max. Load Voltage 30V

Serial Port

- Port Number 1
- Type RS-485
- Data Bits 7, 8
- Stop Bits 1, 2
- Parity None, Odd, Even
- Baud Rate (bps) 1200, 2400, 4800, 9600, 19200, 38400, 57600, 115200
- Protocol Modbus/RTU (Total 64 addresses by 30 max. instructions)

WISE-S251 (6DI/1RS-485)

Digital Input

- Channels 6 (Dry Contact)
- Supports 200Hz Counter Input (32-bit + 1-bit overflow)
- Supports keep/discard counter value on power-off
- Support inverted digital input status

Serial Port

- Port Number 1
- Type RS-485
- Data Bits 7, 8
- Stop Bits 1, 2
- Parity None, Odd, Even
- Baud Rate (bps) 1200, 2400, 4800, 9600, 19200, 38400, 57600, 115200
- Protocol Modbus/RTU (Total 64 address by max. 20 instructions)

WISE-S472 (1DI/2COM) IP65

Serial Port

- Port Number 2
- Type Port 1: RS-485; Port 2: RS-485/232
- Serial Signal RS-485: DATA+, DATARS-, 232: Tx, Rx, GND
- Data Bits 7, 8
- Stop Bits 1, 2
- Parity None, Odd, Even
- Baud Rate (bps) 1200, 2400, 4800, 9600, 19200, 38400, 57600, 115200
- Protection 15 kV ESD
- Protocol Modbus/RTU (Total 32 address by max. 8 instructions)

Digital Input

- Channels 1
- Input Type Dry Contact (Wet Contact by request)
- Logic Level 0: Open; 1: Close to DCOM
- Supports 200Hz Counter Input (32-bit + 1-bit overflow)
- Keep/Discard Counter Value when Power-off
- Supports 200Hz Frequency Input
- Supports Inverted DI Status

Environment

- Operating Temperature -20 ~ 60°C
- Storage Temperature -40 ~ 85°C
- Operating Humidity 20 ~ 95% RH
- Storage Humidity 0 ~ 95% RH

Ordering Information

- WISE-4471-UA Cat. NB1/Cat. M1 Wireless Module

WISE-S200 I/O Module

- WISE-S214-A 4AI/4DI
- WISE-S250-A 6DI, 2DO & 1RS-485
- WISE-S251-A 6DI & 1RS-485

WISE-S400 IP65 I/O Module

- WISE-S414-A 4AI (Upon Request)
- WISE-S472-A 1DI, 1RS-485, 1RS-485/RS-232

Accessories

- PWR-242-AE DIN Rail Power Supply (2.1A Output Current)
- PWR-243-AE Panel Mount Power Supply (3A Output Current)
- PWR-244-AE Panel Mount Power Supply (4.2A Output Current)
- 1654011516-01 M12 Connector 8P Male
- 1655005903-01 M12 Connector 4P Female
- 1700028162-01 2M M12 code-A 4-pin female cable for power wiring
- 1700028163-01 2M M12 code-D 8-pin male cable for I/O wiring

Dimensions

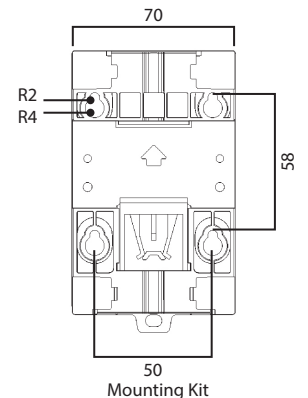
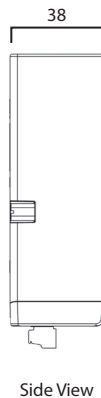
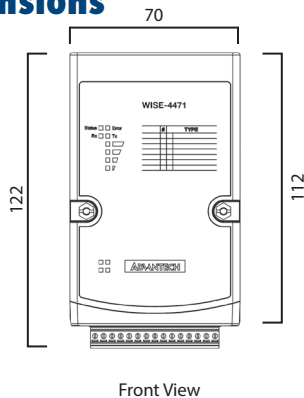

Unit: mm