

WLB92 Industrial LED Light Bar (AC Conduit)



Datasheet

Banner's WLB92 is a very bright LED fixture/luminaire that features an even light output for a no glare glow. The WLB92 series is designed for a wide variety of environments and applications, including but not limited to work stations, machine lighting, and low bay lighting. The WLB92 uses advanced LED lighting technology to provide a high-quality and maintenance free industrial lighting solution.

- Increase worker productivity and ergonomics with bright, high-quality, uniform light
- Exceptionally energy efficient for overall cost savings
- Durable light with a rugged metal housing and shatter-resistant window
- Easy installation with surface mount brackets or choice of snap, swivel, or hanging brackets
- Intensity can be controlled from 10% to 100% using a compatible dimmer
- Rated for use at 100 V ac to 277 V ac

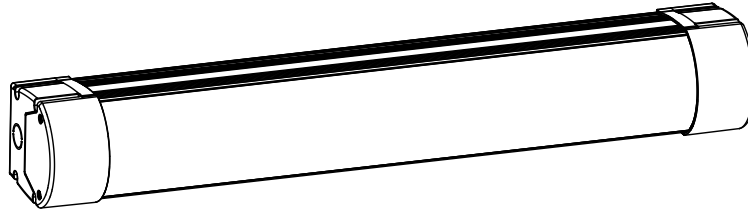

WLB92 Industrial LED Light Bar, AC conduit versions, are continuous run models that come with 1/2-inch conduit knockouts on the side and back of both end caps that allow for lights to be cascaded or "daisy-chained" for a continuous length of light. All conduit models are compatible with select dimming units (see Accessories). WLB92 (AC) Daylight White and Warm White models come with a five year, limited warranty.

To view or download the latest technical information about this product, including specifications, dimensions, accessories, and wiring, see www.bannerengineering.com.



Important: Read the following instructions before operating the light. Please download the complete WLB92 Industrial LED Light Bar (AC Conduit) technical documentation, available in multiple languages, from www.bannerengineering.com for details on the proper use, applications, Warnings, and installation instructions of this device.



Important: Lea el siguiente instructivo antes de operar el luminario. Por favor descargue desde www.bannerengineering.com toda la documentación técnica de los WLB92 Industrial LED Light Bar (AC Conduit), disponibles en múltiples idiomas, para detalles del uso adecuado, aplicaciones, advertencias, y las instrucciones de instalación de estos dispositivos.



Important: Lisez les instructions suivantes avant d'utiliser le luminaire. Veuillez télécharger la documentation technique complète des WLB92 Industrial LED Light Bar (AC Conduit) sur notre site www.bannerengineering.com pour les détails sur leur utilisation correcte, les applications, les notes de sécurité et les instructions de montage.

Models

Family	Voltage	Cascadable	LED Color	Lighted Length (mm)	Control	Connector
WLB92	Z	C		550	A	CT
	Z = AC	C = Cascadable	Blank = Daylight White WW = Warm White G = Green R = Red Y = Yellow B = Blue	550 1100	A = 0-10 V Analog Dimming	CT = Conduit Entry



Installing the WLB92 Industrial LED Light Bar (AC Conduit Models)

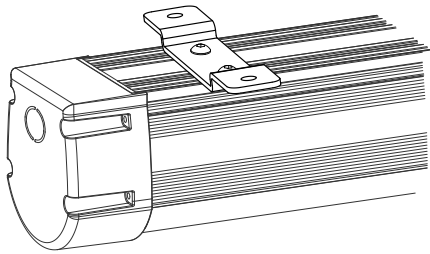

Figure 1. Mounting the luminaire to the surface mount brackets



WARNING: Risk of Electric Shock

- Disconnect or turn off power before installing, removing, or servicing luminaire.
- Luminaire must be installed and connected in accordance with the National Electrical Code (NEC) and any applicable local code requirements.
- Luminaire must be supplied with a 120–277 V ac 50/60 Hz fuse box or circuit breaker

To mount the WLB92 Industrial LED Light Bar, follow these steps.

1. Remove luminaire from packaging and inspect for damage before installing.
2. Locate the supplied surface mount brackets. (For suspended installation, refer to the separate hanging bracket kit and instructions.)
3. Insert the screws into the bracket and then screw on the t-nuts. Attach bracket assembly to luminaire housing as shown. Fully tighten the screws to lock in place.
4. Place the light in the mounting location and mark the positions of the bracket mounting holes.
5. Drill the holes and use the appropriate screws to secure the luminaire to the mounting location.



CAUTION: To Reduce the Risk of Fire. Do not install the 550 mm models in a compartment smaller than 305 mm by 305 mm by 675 mm. Do not install the 1100 mm models in a compartment smaller than 305 mm by 305 mm by 1350 mm.

Wiring the WLB92 Industrial LED Light Bar

Follow these steps to wire your WLB92 Industrial LED Light Bar AC Conduit models.

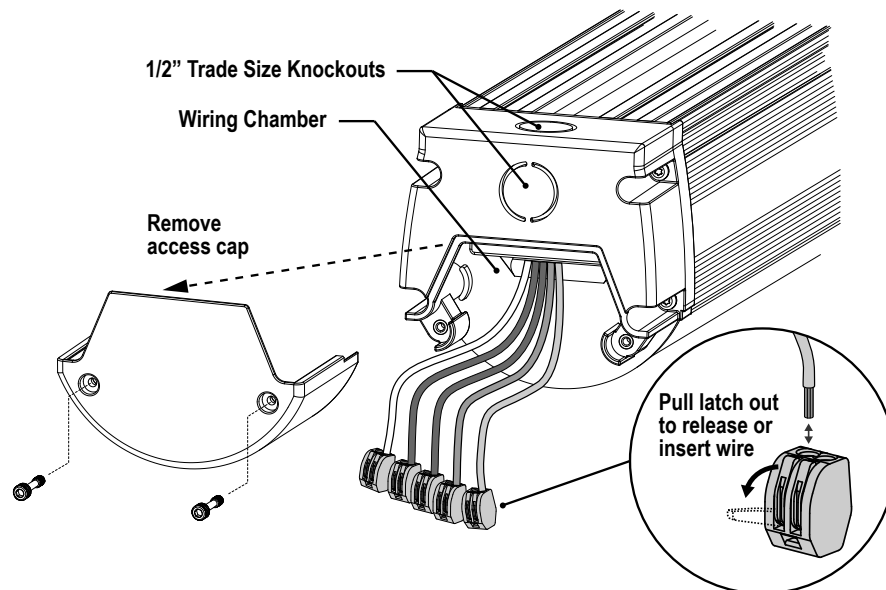

1. Loosen the screws to remove the access cap from the wiring chamber.
2. Connect the power.
 - To connect the power from the back of the luminaire, remove the knockout from the back of the access cap and install either 1/2-inch conduit or an AC power cord with strain relief.
 - To connect the power from the side of the luminaire: remove the knockout from the side of the access cap and install either 1/2-inch conduit or an AC power cord with strain relief on the luminaire wires.
 - If using rigid conduit, the conduit hub/connector must be approved for use in dry or damp locations and must be connected to the conduit before the hub/connector is connected to the luminaire.
3. Pull the luminaire wires out of the wiring chamber, then pull the field wires through the knockouts and out of the wiring chamber.

4. Lift the latch a full 90° on the unused terminal block locations and make the following electrical connections:
 - a) Connect the green/yellow luminaire wire to the AC ground power wire
 - b) Connect the white luminaire wire to the AC neutral power wire
 - c) Connect the black luminaire wire to the AC line power wire
 - d) If using 0–10 V analog dimming, connect the purple luminaire wire to the positive dimming wire
 - e) If using 0–10 V analog dimming, connect the gray luminaire wire to the negative dimming wire
5. Close the latches on each terminal block when you have finished wiring, and push all wires back into the wiring chamber.
6. Re-attach the access cap to the wiring chamber.
7. Repeat steps 1 through 5 on other end of the luminaire if you are connecting to more than one luminaire in a continuous run.

Wiring Diagram

Diagram	Wire	Connection
	L - Black	Line/Hot
	N - White	Neutral
	- Green/Yellow	Earth ground
	Dim (+) - Purple	0–10 V dc analog dimming
	Dim (-) - Gray	Return analog dimming

Specifications

Supply Voltage

Nominal voltage: 120 V ac to 277 V ac, 60 Hz in North America
Nominal voltage: 100 V ac to 277 V ac, 50/60 Hz outside North America
Power factor: > 0.95 at 120 V ac and > 0.90 at 277 V ac
Total harmonic distortion (THD): < 20%
 See electrical characteristics on product label

Supply Current

Lighted Length (mm)	Max. Current Draw (A) at 90 V ac	Typical Current Draw (A)		
		120 V ac	230 V ac	277 V ac
550	0.425	0.270	0.145	0.135
1100	0.850	0.540	0.285	0.250

Supply Protection Circuitry

Protected against transient voltages

Light Characteristics

Daylight White and Warm White Efficacy: 110 lumens/watt typical at 120 V ac at 25 °C (77 °F)
 CRI: 82, typical

Color	Dominant Wavelength (nm) or Color Temperature (CCT)	Lighted Length Lumens (Typical at 25 °C)	
		550 mm	1100 mm
Daylight White	5000 K (±300 K)	3510	7150
Warm White	3000 K (+225 K, -125 K)	3510	7150
Green	525 nm	1430	2975
Red	625 nm	745	1545
Yellow	590 nm	620	1295
Blue	470 nm	405	840

LED Lifetime

Lumen Maintenance - L₇₀
 When operating within specifications, output will decrease less than 30% after 50,000 hours.

Test Data

LM-79, LM-80, TM-21

Dimming

Compatible with 0–10 V analog LED dimming, dimmable to 10% intensity
 Compatible dimmers are listed in the Accessories section.

Construction

Anodized aluminum housing, polycarbonate window and end caps, and stainless steel mounting brackets

Spacing Criterion

Vertical: 1.20
 Horizontal: 1.32

Mounting

Surface mount brackets included (2)
 Compatible with integral 45 mm aluminum framing mounting slots
 Several optional mounting brackets available (see Accessories)

Connections

1/2-inch trade size conduit knockout

Environmental Rating

IEC IP40

Operating Temperature for 550 mm Lighted Length Models

Surface Mount Installation: –35 °C to +50 °C (–31 °F to +122 °F) for 24 hours per day for 5 years of operation
Hanging Installation (> 0.5 m from ceiling): –35 °C to +50 °C (–31 °F to +122 °F) for 24 hours per day for 5 years of operation

Operating Temperature for 1100 mm Lighted Length Models

Surface Mount Installation: –40 °C to +45 °C (–40 °F to +113 °F) for 16 hours per day for 5 years of operation; or –40 °C to +35 °C (–40 °F to +95 °F) for 24 hours per day for 5 years of operation
Hanging Installation (> 0.5 m from ceiling): –40 °C to +50 °C (–40 °F to +122 °F) for 16 hours per day for 5 years of operation; or –40 °C to +45 °C (–40 °F to +113 °F) for 24 hours per day for 5 years of operation

Storage Temperature

–40 °C to +70 °C (–40 °F to +158 °F)

Vibration and Mechanical Shock

Vibration: 10 Hz to 55 Hz, 0.5 mm peak-to-peak amplitude per IEC 60068-2-6
 Shock: 5G 11 ms duration, half sine wave per IEC 60068-2-27

Application Notes

When connecting continuous run/cascadable lights in series, it is important not to exceed maximum current limitations of 14 AWG, 75 °C wire, in accordance with the National Electrical Code (NEC) and any applicable local code requirements.

Certifications



Spacing Criteria (SC)

The spacing criteria is the fixture-spacing-to-mounting-height ratio and aids in laying out a pattern of fixtures. Multiply the spacing criteria by the mounting height to get the maximum fixture spacing that still provides even illumination (no shadowing between fixtures).

Luminaire Spacing = SC × Height to Illuminated Plane

The mounting height is the distance from the fixture to the surface you are lighting.

Performance Curves

550 mm Models - Daylight White and Warm White

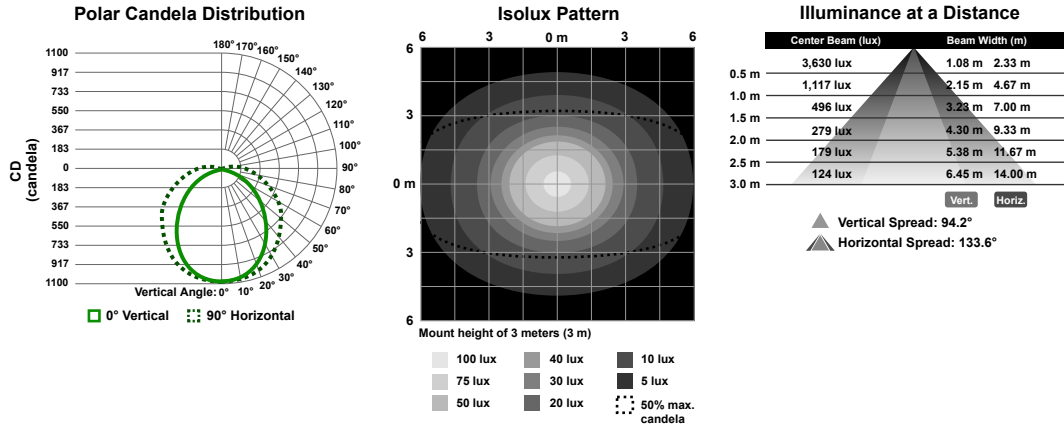

1100 mm Models - Daylight White and Warm White

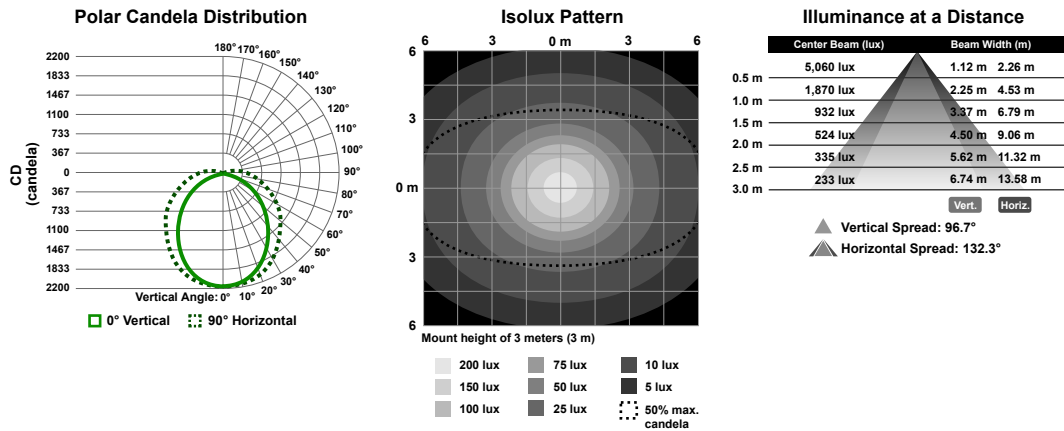

Dimensions

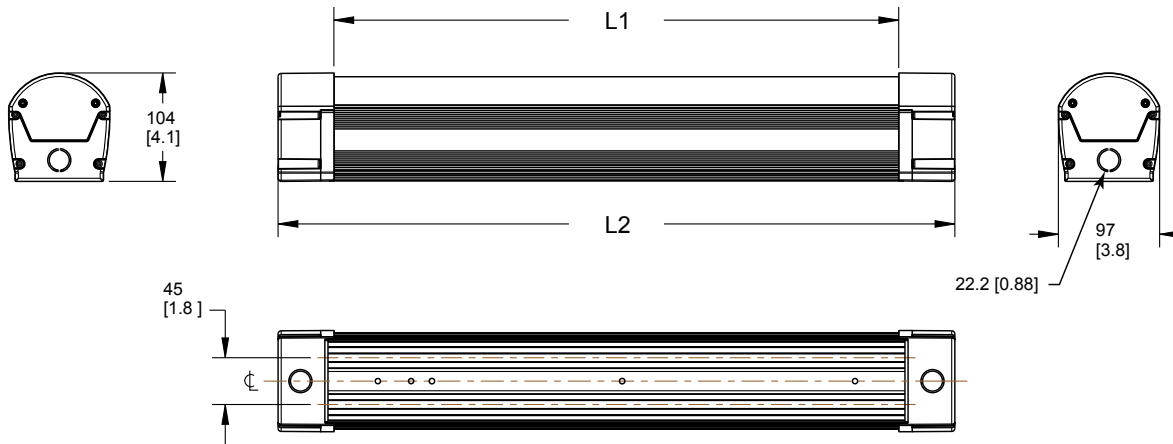

Model	L1	L2
WLB92ZC...550ACT	543 mm (21.4 in)	651 mm (25.6 in)
WLB92ZC...1100ACT	1098 mm (43.2 in)	1206 mm (47.5 in)

Accessories

Brackets

LMBWLB92

- Standard bracket that ships with the WLB92 light
- Stainless steel
- Includes two surface mount brackets, four screws, and four t-nuts

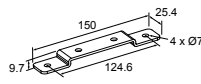

LMBWLB92CLIP

- Snap clip allows for tool-less installation
- Stainless steel
- Includes four snap clips, four screws, and two insulator caps

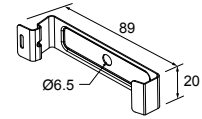

LMBWLB92HK5

- Hanging bracket kit allows for suspended installation
- Includes two hanging bracket assemblies, four screws, four t-nuts, and two 15-24 mm cables

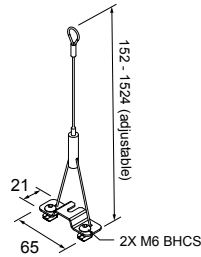

LMBWLB92RAS

- Swivel brackets allow for 180° of movement in seven fixed positions
- Stainless steel
- Includes two swivel bracket assemblies, eight screws, and four t-nuts

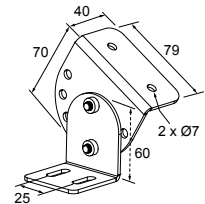

LMBWLB92S

- Surface mount brackets allow for mounting at the end of the light
- Stainless steel
- Includes two end brackets, four screws, and four t-nuts

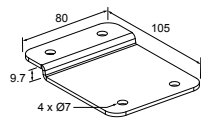

Dimmers

Dimmers with Full Dimming Range:

Lutron Diva Family

DVST-XX
DVSCSTV-XX

Lutron Nova T Family

NTSTV-DV-XX

Lutron Maestro Family (dimmer with sensor)

MS-Z101-XX

Dimmers with Limited Dimming Range:

Leviton Illumatech Family

IP710-LFZ

Leviton Renoir II Family

AWSMT-7DW
AWSMG-7DW
AWRMG-7DW

Banner Engineering Corp. Limited Warranty

Banner Engineering Corp. warrants its products to be free from defects in material and workmanship for five years on daylight white and warm white models and one year on all other models following the date of shipment. Banner Engineering Corp. will repair or replace, free of charge, any product of its manufacture which, at the time it is returned to the factory, is found to have been defective during the warranty period. This warranty does not cover damage or liability for misuse, abuse, or the improper application or installation of the Banner product.

THIS LIMITED WARRANTY IS EXCLUSIVE AND IN LIEU OF ALL OTHER WARRANTIES WHETHER EXPRESS OR IMPLIED INCLUDING, WITHOUT LIMITATION, ANY WARRANTY OF MERCHANTABILITY OR FITNESS FOR A PARTICULAR PURPOSE, AND WHETHER ARISING UNDER COURSE OF PERFORMANCE, COURSE OF DEALING OR TRADE USAGE.

This Warranty is exclusive and limited to repair or, at the discretion of Banner Engineering Corp., replacement. **IN NO EVENT SHALL BANNER ENGINEERING CORP. BE LIABLE TO BUYER OR ANY OTHER PERSON OR ENTITY FOR ANY EXTRA COSTS, EXPENSES, LOSSES, LOSS OF PROFITS, OR ANY INCIDENTAL, CONSEQUENTIAL OR SPECIAL DAMAGES RESULTING FROM ANY PRODUCT DEFECT OR FROM THE USE OR INABILITY TO USE THE PRODUCT, WHETHER ARISING IN CONTRACT OR WARRANTY, STATUTE, TORT, STRICT LIABILITY, NEGLIGENCE, OR OTHERWISE.**

Banner Engineering Corp. reserves the right to change, modify or improve the design of the product without assuming any obligations or liabilities relating to any product previously manufactured by Banner Engineering Corp. Any misuse, abuse, or improper application or installation of this product or use of the product for personal protection applications when the product is identified as not intended for such purposes will void the product warranty. Any modifications to this product without prior express approval by Banner Engineering Corp will void the product warranties. All specifications published in this document are subject to change; Banner reserves the right to modify product specifications or update documentation at any time. Specifications and product information in English supersede that which is provided in any other language. For the most recent version of any documentation, refer to: www.bannerengineering.com.

For patent information, see www.bannerengineering.com/patents.