

APPROVAL SHEET

WLBD1005 Chip Bead

*Contents in this sheet are subject to change without prior notice.

FEATURES

- 1. Closed magnetic circuit.

APPLICATIONS

- 1. Noise reduction for general signal and DC line for General electronic circuits. Ex:PCs、Networking and Consumer electronics.

SHAPE and DIMENSION

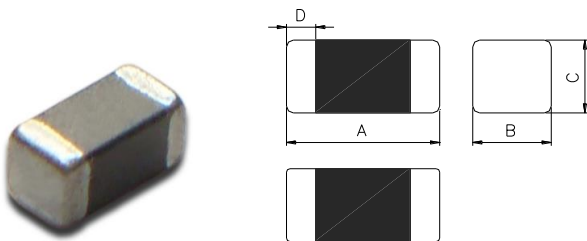

Chip Size	
A	1.00±0.10
B	0.50±0.10
C	0.50±0.10
D	0.25±0.10

Units: mm

Ordering Information

WL	BD	1005	K1	U	300	T	B
Product Code WL: Inductor	Series BD: Chip Bead.	Dimensions 1.0 * 0.5 mm 1005 :EIA 0402	Series extension Refer to characteristic	Tolerance U: ±25%	Value 300 =30 OHM 301 =300 OHM 102 =1000OHM	Packing Code T = 7" Paper Tape	B:STD

Electrical Characteristics

● WLBD1005 series

Walsin Part Number	Impedance (Ω)	Test Frequency (MHz)	DC Resistance (Ω) max.	Rated Current (mA) max.
WLBD1005K1U300TB	30 \pm 25%	100	0.20	300
WLBD1005K1U600TB	60 \pm 25%	100	0.25	300
WLBD1005K1U121TB	120 \pm 25%	100	0.30	100
WLBD1005K1U151TB	150 \pm 25%	100	0.30	100
WLBD1005K1U221TB	220 \pm 25%	100	0.40	100
WLBD1005K1U301TB	300 \pm 25%	100	0.50	100
WLBD1005K1U471TB	470 \pm 25%	100	0.65	100
WLBD1005K1U601TB	600 \pm 25%	100	0.80	80
WLBD1005K1U102TB	1000 \pm 25%	100	1.20	50

Characteristic Curve

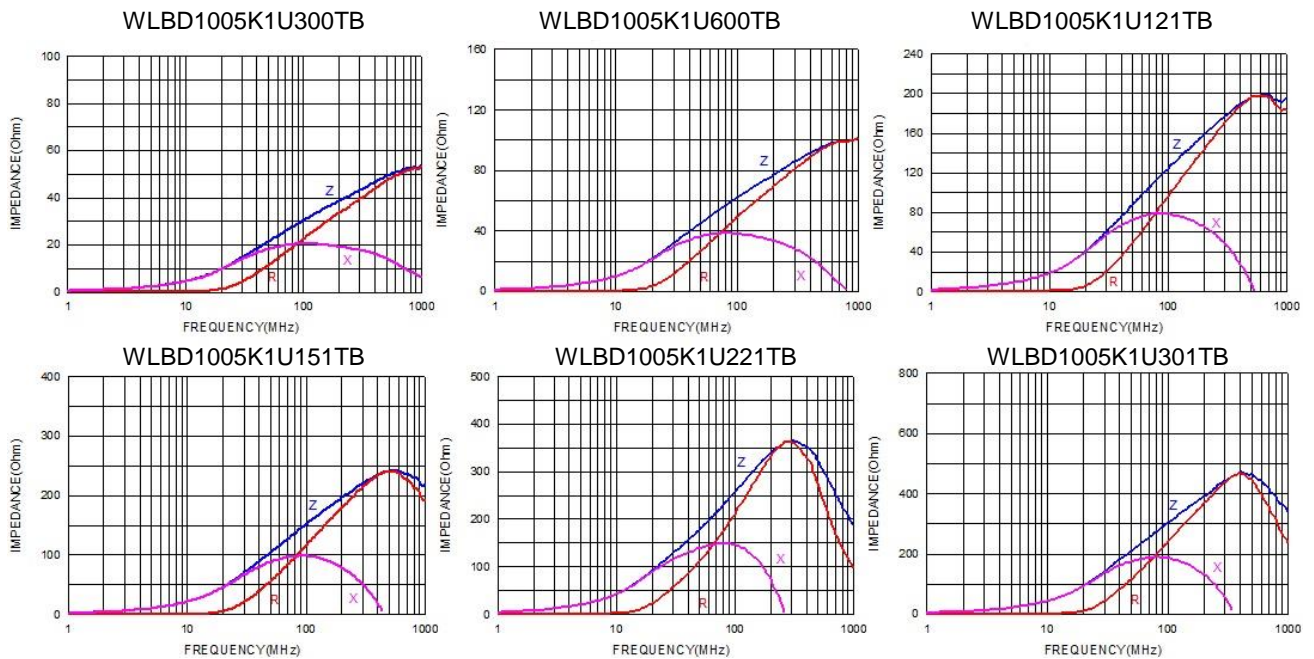

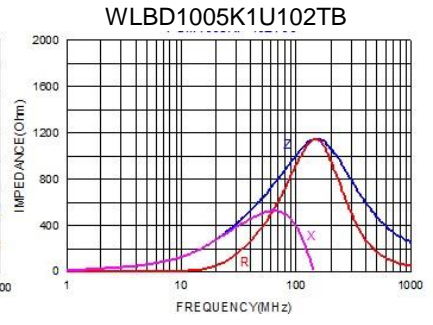
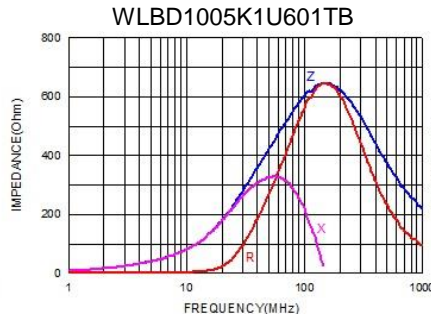
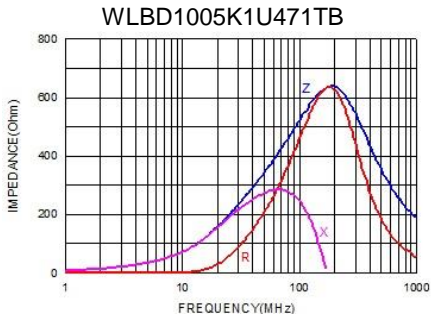

Test condition & Requirements

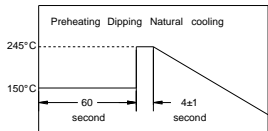
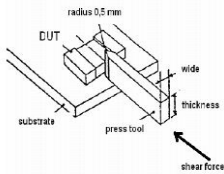
Item	Performance	Test Condition															
Operating Temperature	-40~+125°C (Including self-temperature rise)	--															
Transportation Storage Temperature	-40~+125°C (on board)	For long storage conditions, please see the Application Notice															
Impedance (Z)	Refer to standard electrical characteristics list	Agilent4291															
Inductance (Ls)		Agilent E4991															
Q Factor		Agilent4287															
DC Resistance		Agilent16192															
Rated Current		Agilent 4338															
Temperature Rise Test	Rated Current < 1A ΔT 20°C Max Rated Current ≥ 1A ΔT 40°C Max	1. Applied the allowed DC current. 2. Temperature measured by digital surface thermometer.															
Resistance to Soldering Heat	Appearance : No damage. Impedance : within±15% of initial value Inductance : within±10% of initial value Q : Shall not exceed the specification value. RDC : within ±15% of initial value and shall not exceed the specification value	Number of heat cycles: 1 <table border="1"> <thead> <tr> <th>Temperature (°C)</th> <th>Time (s)</th> <th>Temperature ramp/immersion and emersion rate</th> </tr> </thead> <tbody> <tr> <td>260 ±5 (solder temp)</td> <td>10 ±1</td> <td>25mm/s ±6 mm/s</td> </tr> </tbody> </table> Depth: completely cover the termination	Temperature (°C)	Time (s)	Temperature ramp/immersion and emersion rate	260 ±5 (solder temp)	10 ±1	25mm/s ±6 mm/s									
Temperature (°C)	Time (s)	Temperature ramp/immersion and emersion rate															
260 ±5 (solder temp)	10 ±1	25mm/s ±6 mm/s															
Solderability	More than 95% of the terminal electrode should be covered with solder. 	Preheat: 150°C, 60sec. Solder: Sn96.5%-Ag3%-Cu0.5% Solder temperature: 245±5°C Flux for lead free: Rosin. 9.5% Depth: completely cover the termination. Dip time: 4±1sec.															
Terminal strength	Appearance : No damage. Impedance : within±15% of initial value Inductance : within±10% of initial value Q : Shall not exceed the specification value. RDC : within ±15% of initial value and shall not exceed the specification value 	Preconditioning: Run through IR reflow for 2 times.(IPC/JEDEC J-STD-020D Classification Reflow Profiles) Component mounted on a PCB apply a force (>0805:1kg <=0805:0.5kg)to the side of a device being tested. This force shall be applied for 60 +1 seconds. Also the force shall be applied gradually as not to shock the component being tested.															
Bending	Appearance : No damage. Impedance : within±10% of initial value Inductance : within±10% of initial value Q : Shall not exceed the specification value. RDC : within ±15% of initial value and shall not exceed the specification value	Shall be mounted on a FR4 substrate of the following dimensions:>=0805:40x100x1.2mm <0805:40x100x0.8mm Bending depth:>=0805:1.2mm <0805:0.8mm Duration of 10 sec for a min.															
Vibration Test	Appearance : No damage. Impedance : within±15% of initial value Inductance : within±10% of initial value Q : Shall not exceed the specification value. RDC : within ±15% of initial value and shall not exceed the specification value	Preconditioning: Run through IR reflow for 2 times.(IPC/JEDEC J-STD-020D Classification Reflow Profiles) Oscillation Frequency: 10~2K~10Hz for 20 minutes Equipment : Vibration checker Total Amplitude:1.52mm±10% Testing Time : 12 hours(20 minutes, 12 cycles each of 3 orientations) °															
Shock	Appearance : No damage. Impedance : within±10% of initial value Inductance : within±10% of initial value Q : Shall not exceed the specification value. RDC : within ±15% of initial value and shall not exceed the specification value	Test condition: <table border="1"> <thead> <tr> <th>Type</th> <th>Peak Value (g's)</th> <th>Normal duration (D) (ms)</th> <th>Wave form</th> <th>Velocity change (Vi)ft/sec</th> </tr> </thead> <tbody> <tr> <td>SMD</td> <td>50</td> <td>11</td> <td>Half-sine</td> <td>11.3</td> </tr> <tr> <td>Lead</td> <td>50</td> <td>11</td> <td>Half-sine</td> <td>11.3</td> </tr> </tbody> </table>	Type	Peak Value (g's)	Normal duration (D) (ms)	Wave form	Velocity change (Vi)ft/sec	SMD	50	11	Half-sine	11.3	Lead	50	11	Half-sine	11.3
Type	Peak Value (g's)	Normal duration (D) (ms)	Wave form	Velocity change (Vi)ft/sec													
SMD	50	11	Half-sine	11.3													
Lead	50	11	Half-sine	11.3													

Item	Performance	Test Condition
Life test	Appearance: no damage.	Preconditioning: Run through IR reflow for 2 times.(IPC/JEDEC J-STD-020D Classification Reflow Profiles) Temperature: 125±2°C (bead), 105±2°C (Inductor) Applied current: rated current. Duration: 1000±12hrs. Measured at room temperature after placing for 24±2 hrs.
Load Humidity	Impedance: within±15%of initial value. Inductance: within±10%of initial value. Q : Shall not exceed the specification value. RDC : within ±15% of initial value and shall not exceed the specification value	Preconditioning: Run through IR reflow for 2 times.(IPC/JEDEC J-STD-020D Classification Reflow Profiles) Humidity: 85±2%R.H. Temperature: 85±2°C. Duration: 1000hrs Min. with 100% rated current. Measured at room temperature after placing for 24±2 hrs.
Thermal shock	Appearance: no damage. Impedance: within±15%of initial value. Inductance: within±10%of initial value. Q : Shall not exceed the specification value. RDC : within ±15% of initial value and shall not exceed the specification value	Preconditioning: Run through IR reflow for 2 times.(IPC/JEDEC J-STD-020D Classification Reflow Profiles) Condition for 1 cycle Step1: -40±2°C 30±5 min. Step2: 25±2°C ≤0.5min Step3: +125±2°C 30±5min. (Bead) Step3: +105±2°C 30±5min. (Inductor) Number of cycles: 500 Measured at room temperature after placing for 24±2 hrs.

****Derating Curve**

For the ferrite chip bead which withstanding current over 1.5A, as the operating temperature over 85°C, the derating current information is necessary to consider with. For the detail derating of current, please refer to the Derated Current vs. Operating Temperature curve.

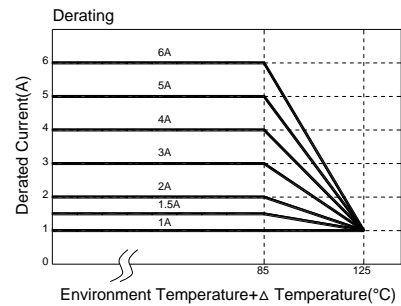

Soldering and Mounting

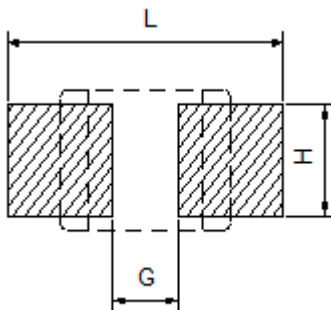

	L (mm)	G (mm)	H (mm)
WLBD1005	1.50	0.40	0.55

