

APPROVAL SHEET

WLBD0603 - 4532

Chip Bead

General Series



*Contents in this sheet are subject to change without prior notice.

FEATURES

1. Monolithic inorganic material construction.
2. Closed magnetic circuit avoids crosstalk.
3. S.M.T. type.
4. Suitable for reflow soldering.
5. Shapes and dimensions follow E.I.A. spec.
6. Available in various sizes.
7. Excellent solder ability and heat resistance.

SHAPE and DIMENSION



| TYPE | 0603 (EIA 0201) | 1005 (EIA 0402) | 1608 (EIA 0603) | 2012 (EIA 0805) | 3216 (EIA 1206) | 3225 (EIA 1210) | 4516 (EIA 1806) | 4532 (EIA 1812) |
|------|--------------------|--------------------|--------------------|--------------------|--------------------|--------------------|--------------------|--------------------|
| L | 0.60±0.03 | 1.00±0.10 | 1.60±0.15 | 2.00±0.20 | 3.20±0.20 | 3.20±0.20 | 4.50±0.25 | 4.50±0.25 |
| W | 0.30±0.03 | 0.50±0.10 | 0.80±0.15 | 1.25±0.20 | 1.60±0.20 | 2.50±0.20 | 1.60±0.20 | 3.20±0.25 |
| T | 0.30±0.03 | 0.50±0.10 | 0.80±0.15 | 0.90±0.20 | 1.10±0.20 | 1.30±0.20 | 1.60±0.20 | 1.50±0.25 |
| E | 0.15±0.05 | 0.25±0.10 | 0.30±0.20 | 0.50±0.30 | 0.50±0.30 | 0.50±0.30 | 0.60±0.40 | 0.60±0.40 |
| Unit | mm | | | | | | | |

Ordering Information

| WL | BD | 0603 - 4532 | K2 | U | 300 | T/P | P/B |
|--|------------------------------------|--|---|---------------------------------|---|---|--|
| Product Code WL: Inductor | Series BD: Chip Bead. | Dimensions JIS: (EIA) 0603 : (0201) 1005 : (0402) 1608: (0603) 2012: (0805) 3216: (1206) 3225: (1210) 4516: (1806) 4532: (1812) | Series extension Refer to characteristic | Tolerance U: ±25% | Value 300 =30 OHM 601 =600 OHM 102 =1000OHM | Packing Code T = 7" Paper Tape P = 7" Plastic Tape | P/B/F/G Internal code |

PART NUMBER AND CHARACTERISTICS TABLE

WLBD0603 - 1005 series

| Walsin Part Number | Impedance (Ω) +/-25% | Test Frequency (MHz) | DC Resistance (Ω) max. | Rated Current (mA) max. |
|--------------------|----------------------------------|-------------------------|------------------------------------|----------------------------|
| WLBD0603K2U220TP | 22 | 100 | 0.065 | 500 |
| WLBD0603K2U330TP | 33 | 100 | 0.07 | 500 |
| WLBD0603K2U800TP | 80 | 100 | 0.40 | 200 |
| WLBD0603K2U121TP | 120 | 100 | 0.50 | 200 |
| WLBD0603K2U241TP | 240 | 100 | 0.80 | 200 |
| WLBD0603K2U601TP | 600 | 100 | 1.20 | 150 |
| WLBD0603K2U102TP | 1000 | 100 | 1.15 | 200 |
| WLBD0603K2U600TB | 60 | 100 | 0.25 | 200 |
| WLBD0603K2U121TB | 120 | 100 | 0.40 | 250 |
| WLBD0603K2U241TB | 240 | 100 | 0.80 | 200 |
| WLBD0603K2U471TB | 470 | 100 | 1.05 | 220 |
| WLBD0603K2U601TB | 600 | 100 | 1.20 | 200 |
| Walsin Part Number | Impedance (Ω) +/-25% | Test Frequency (MHz) | DC Resistance (Ω) max. | Rated Current (mA) max. |
| WLBD1005K2U100TP | 10 | 100 | 0.10 | 300 |
| WLBD1005K2U200TP | 20 | 100 | 0.20 | 300 |
| WLBD1005K2U300TP | 30 | 100 | 0.25 | 300 |
| WLBD1005K2U400TP | 40 | 100 | 0.30 | 300 |
| WLBD1005K2U600TP | 60 | 100 | 0.35 | 300 |
| WLBD1005K2U700TP | 70 | 100 | 0.35 | 300 |
| WLBD1005K2U121TP | 120 | 100 | 0.40 | 300 |
| WLBD1005K2U241TP | 240 | 100 | 0.70 | 200 |
| WLBD1005K2U301TP | 300 | 100 | 0.80 | 200 |
| WLBD1005K2U471TP | 470 | 100 | 1.00 | 200 |
| WLBD1005K2U601TP | 600 | 100 | 1.00 | 300 |
| WLBD1005K2U102TP | 1000 | 100 | 1.50 | 200 |
| WLBD1005K2U102TF | 1000 | 100 | 1.50 | 300 |
| WLBD1005K2U102TG | 1000 | 100 | 0.7 | 400 |

PART NUMBER AND CHARACTERISTICS TABLE

WLBD1608 - 3216 series

| Walsin Part Number | Impedance (Ω) +/-25% | Test Frequency (MHz) | DC Resistance (Ω) max. | Rated Current (mA) max. |
|--------------------|----------------------------------|-------------------------|------------------------------------|----------------------------|
| WLBD1608K2U100TP | 10 | 100 | 0.05 | 600 |
| WLBD1608K2U300TP | 30 | 100 | 0.08 | 600 |
| WLBD1608K2U600TP | 60 | 100 | 0.10 | 600 |
| WLBD1608K2U800TP | 80 | 100 | 0.10 | 600 |
| WLBD1608K2U121TP | 120 | 100 | 0.15 | 600 |
| WLBD1608K2U181TP | 180 | 100 | 0.30 | 300 |
| WLBD1608K2U221TP | 220 | 100 | 0.30 | 500 |
| WLBD1608K2U301TP | 300 | 100 | 0.35 | 500 |
| WLBD1608K2U331TP | 330 | 100 | 0.30 | 500 |
| WLBD1608K2U471TP | 470 | 100 | 0.40 | 300 |
| WLBD1608K2U601TP | 600 | 100 | 0.45 | 200 |
| WLBD1608K2U102TP | 1000 | 100 | 0.60 | 200 |
| WLBD1608K2U152TP | 1500 | 100 | 0.60 | 500 |
| WLBD1608K2U182TP | 1800 | 100 | 0.70 | 100 |
| WLBD1608K2U252TP | 2500 | 100 | 0.70 | 100 |
| WLBD1608K2U252TB | 2500 | 100 | 0.70 | 200 |
| Walsin Part Number | Impedance (Ω) +/-25% | Test Frequency (MHz) | DC Resistance (Ω) max. | Rated Current (mA) max. |
| WLBD2012K2U300TP | 30 | 100 | 0.05 | 800 |
| WLBD2012K2U400TP | 40 | 100 | 0.05 | 800 |
| WLBD2012K2U600TP | 60 | 100 | 0.15 | 800 |
| WLBD2012K2U800TP | 80 | 100 | 0.15 | 800 |
| WLBD2012K2U121TP | 120 | 100 | 0.15 | 800 |
| WLBD2012K2U221TP | 220 | 100 | 0.20 | 500 |
| WLBD2012K2U301TP | 300 | 100 | 0.20 | 500 |
| WLBD2012K2U601TP | 600 | 100 | 0.30 | 500 |
| WLBD2012K2U102TP | 1000 | 100 | 0.35 | 300 |
| WLBD2012K2U202TP | 2000 | 100 | 0.50 | 200 |
| Walsin Part Number | Impedance (Ω) +/-25% | Test Frequency (MHz) | DC Resistance (Ω) max. | Rated Current (mA) max. |
| WLBD3216K2U310PP | 31 | 100 | 0.05 | 800 |
| WLBD3216K2U500PP | 50 | 100 | 0.08 | 800 |
| WLBD3216K2U700PP | 70 | 100 | 0.10 | 800 |
| WLBD3216K2U121PP | 120 | 100 | 0.15 | 600 |
| WLBD3216K2U601PP | 600 | 100 | 0.30 | 500 |
| WLBD3216K2U102PP | 1000 | 100 | 0.40 | 500 |
| WLBD3216K2U122PP | 1200 | 100 | 0.40 | 500 |
| WLBD3216K2U152PP | 1500 | 50 | 0.50 | 200 |
| WLBD3216K2U202PP | 2000 | 30 | 0.50 | 200 |

PART NUMBER AND CHARACTERISTICS TABLE

WLBD3225 - 4532 series

| Walsin Part Number | Impedance (Ω) +/-25% | Test Frequency (MHz) | DC Resistance (Ω) max. | Rated Current (mA) max. |
|--------------------|--|----------------------|------------------------|-------------------------|
| WLBD3225K2U600PP | 60 | 100 | 0.30 | 800 |
| WLBD3225K2U900PP | 90 | 100 | 0.30 | 800 |
| Walsin Part Number | Impedance (Ω) +/-25% | Test Frequency (MHz) | DC Resistance (Ω) max. | Rated Current (mA) max. |
| WLBD4516K2U800PP | 80 | 100 | 0.10 | 800 |
| WLBD4516K2U151PP | 150 | 100 | 0.30 | 800 |
| Walsin Part Number | Impedance (Ω) +/-25% | Test Frequency (MHz) | DC Resistance (Ω) max. | Rated Current (mA) max. |
| WLBD4532K2U700PP | 70 | 100 | 0.40 | 800 |
| WLBD4532K2U800PP | 80 | 100 | 0.40 | 800 |
| WLBD4532K2U121PP | 120 | 100 | 0.40 | 800 |
| Test Level : | 250 mV | | | |
| Test Instruments : | <ul style="list-style-type: none"> •HP4291B RF IMPEDANCE / MATERIAL ANALYZER •HP4338A/B MILLIOHMMETER •Agilent 8720ES S-PARAMETER NETWORK ANALYZER •HP6632B SYSTEM DC POWER SUPPLY | | | |

Land Patterns for Reflow Soldering

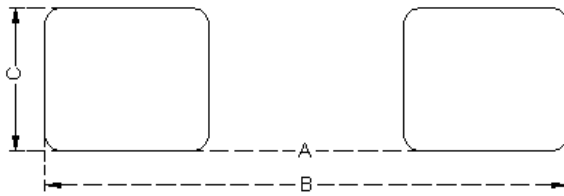

Solder Land Information

Unit: mm (inches)

| Size | A | B | C |
|------|-------------|-------------------------|--------------|
| 0603 | 10±1.5 | 50 or more | 13±0.2 |
| 1005 | 0.4 (0.016) | 1.2 ~1.4 (0.047 ~0.055) | 0.5 (0.020) |
| 1608 | 0.7 (0.028) | 1.8~ 2.0 (0.071~ 0.079) | 0.7 (0.028) |
| 2012 | 1.2 (0.047) | 3.0 ~4.0 (0.118 ~0.157) | 1.0 (0.039) |
| 3216 | 2.0 (0.079) | 4.2 ~5.2 (0.165 ~0.205) | 1.2 (0.047) |
| 3225 | 2.0 (0.079) | 4.2 ~5.2 (0.165 ~0.205) | 3.4 (0.134) |
| 4516 | 3.0 (0.118) | 5.5~6.5 (0.217 ~0.256) | 1.2 (0.047) |
| 4532 | 3.0 (0.118) | 5.5 ~6.5 (0.217 ~0.256) | 4.22 (0.166) |

RELIABILITY AND TEST CONDITION

| Test item | Test condition | Criteria |
|---------------------------|--|--|
| Temperature Cycle | Temperature : -40 ~ +125°C Cycle : 100 cycles Dwell time : 30minutes Measurement : at ambient temperature 24 hours after test completion | No mechanical damage Impedance value should be within $\pm 20\%$ of the initial value |
| Operational Life | Temperature : 125°C $\pm 5^\circ\text{C}$ Test time : 1000 hours Apply current : full rated current Measurement : at ambient temperature 24 hours after test completion | No mechanical damage Impedance value should be within $\pm 20\%$ of the initial value |
| Biased Humidity | Temperature : 40°C $\pm 2^\circ\text{C}$ Humidity : 90 ~ 95 % RH Test time : 1000 hours Apply current : full rated current Measurement : at ambient temperature 24 hours after test completion | No mechanical damage Impedance value should be within $\pm 20\%$ of the initial value |
| Resistance to Solder Heat | Solder temperature : 260 $\pm 5^\circ\text{C}$ Flux : Rosin DIP time : 10 ± 1 sec | More than 95 % of terminal electrode should be covered with new solder No mechanical damage Impedance value should be within $\pm 20\%$ of the initial value |
| Adhesive Test | Reflow temperature : 245°C. It shall be Soldered on the substrate applying direction parallel to the substrate Apply force(F) : 5 N Test time : 10 sec | No mechanical damage Soldering the products on PCB after the pulling test force > 5 N |
| Steam Aging Test | Temperature : 93°C Test time : 4 hrs(WLCM1005) Others : 8 hours c. Solder temperature : 235 $\pm 5^\circ\text{C}$ Flux : Rosin e. DIP time : 5 ± 1 sec | More than 95 % of terminal electrode should be covered with new solder |
| Rated Current Test | Apply current : full rated current / 5min | Temperature rise should be less than 25°C |

GENERAL TECHNICAL DATA

Operating temperature range : - 55°C ~ +125°C

Storage Condition : Less than 40°C and 70% RH

Storage Time: 6 months(Size:0603,1005)

12 months(Size:1608 above)

Soldering method: Reflow

TAPE AND REEL SPECIFICATIONS PLASTIC CARRIER

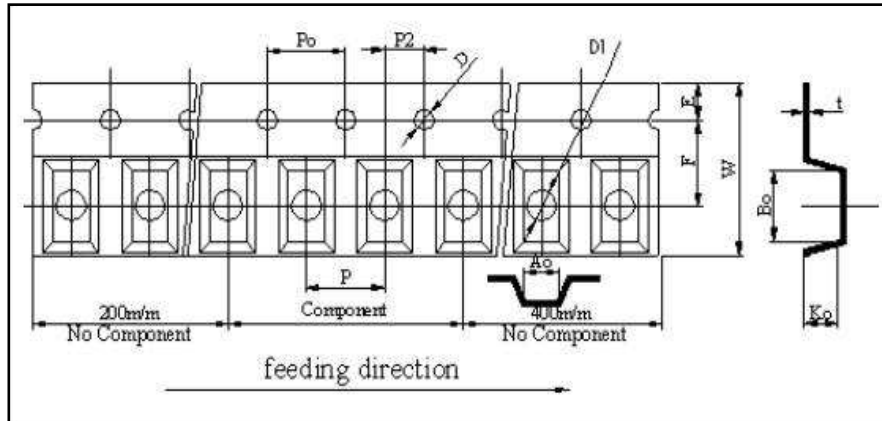

PAPER CARRIER

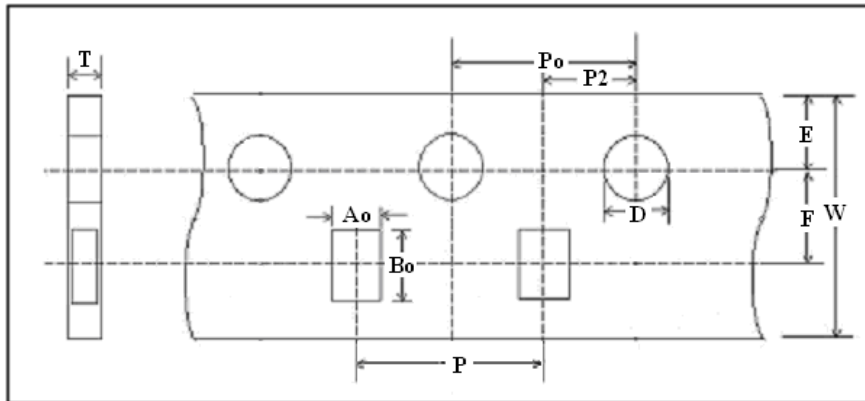

Taping Dimensions

| Size | 4532 | 4516 | 3225 | 3216 | 2012 | 1608 | 1005 | 0603 |
|--------|-----------|-----------|-----------|-----------|-----------|-----------|-----------|-----------|
| Symbol | PLASTIC | PLASTIC | PLASTIC | PLASTIC | PAPER | PAPER | PAPER | |
| W | 12.0±0.10 | 11.7~12.3 | 7.70~8.30 | 7.90~8.30 | 8.00±0.10 | 8.00±0.10 | 8.00±0.10 | |
| P | 8.00±0.10 | 4.00±0.10 | 4.00±0.10 | 4.00±0.10 | 4.00±0.10 | 4.00±0.10 | 2.00±0.05 | 2.1±0.05 |
| E | 1.75±0.10 | 1.75±0.10 | 1.75±0.10 | 1.75±0.10 | 1.75±0.10 | 1.75±0.10 | 1.75±0.05 | |
| F | 5.50±0.05 | 5.50±0.05 | 3.50±0.05 | 3.50±0.05 | 3.50±0.10 | 3.50±0.10 | 3.50±0.05 | |
| D | 1.55±0.05 | 1.55±0.05 | 1.55±0.05 | 1.55±0.05 | 1.56±0.10 | 1.56±0.10 | 1.55±0.05 | |
| D1 | 1.50~1.75 | 1.50~1.75 | 0.95~1.20 | 0.95~1.20 | NA | NA | NA | |
| Po | 4.00±0.10 | 4.00±0.10 | 4.00±0.10 | 4.00±0.10 | 4.00±0.10 | 4.00±0.10 | 4.00±0.10 | |
| Po10 | 40.0±0.20 | 40.0±0.20 | 40.0±0.20 | 40.0±0.20 | 40.0±0.20 | NA | NA | |
| P2 | 2.00±0.05 | 2.00±0.05 | 2.00±0.05 | 2.00±0.05 | 2.00±0.10 | 2.00±0.10 | 2.00±0.05 | |
| Ao | 3.66±0.10 | 1.83±0.10 | 2.57±0.10 | 1.85±0.10 | 1.50±0.05 | 1.05±0.05 | 0.62±0.03 | 0.40±0.06 |
| Bo | 4.95±0.10 | 4.85±0.10 | 3.40±0.10 | 3.43±0.10 | 2.30±0.05 | 1.85±0.05 | 1.12±0.03 | 0.70±0.06 |
| Ko(T) | 1.83±0.10 | 1.83±0.10 | 1.32±0.10 | 1.22±0.10 | 0.95±0.05 | 0.95±0.05 | 0.60±0.03 | 0.45max |
| t | 0.23±0.10 | 0.29±0.10 | 0.25±0.10 | 0.25±0.10 | NA | NA | NA | 0.45max |

REEL DIMENSIONS

Unit: mm

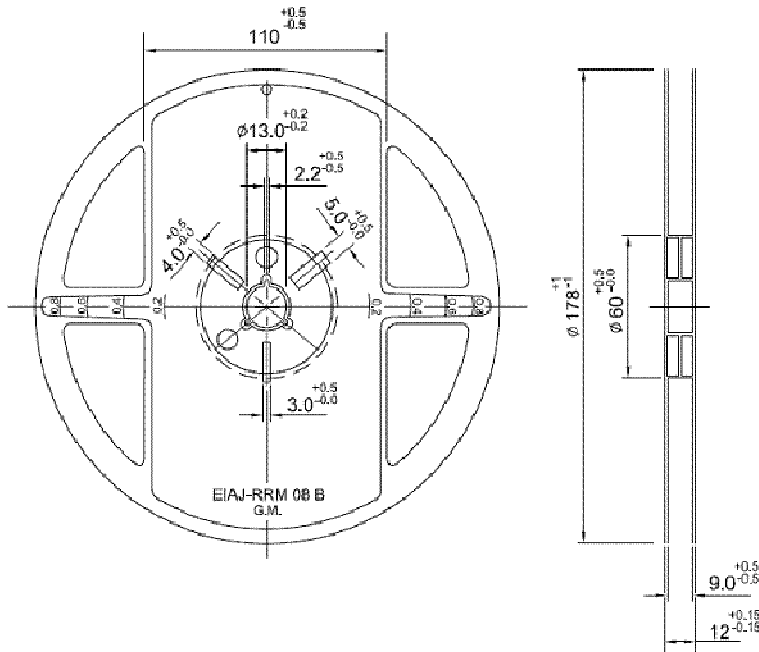

| 7" Reel Packaging Quantity | | | | | | | | |
|----------------------------|------------------------|------------------------|------------------------|------------------------|------------------------|------------------------|------------------------|------------------------|
| PART SIZE (EIA SIZE) | 0603 (0201) | 1005 (0402) | 1608 (0603) | 2012 (0805) | 3216 (1206) | 3225 (1210) | 4516 (1806) | 4532 (1812) |
| Qty.(pcs) | 15,000 | 10,000 | 4,000 | 4,000 | 3,000 | 2,000 | 2,000 | 1,000 |
| BOX | 5 reels / inner box | | | | | | 4 reels / inner box | |

RECOMMENDED SOLDERING CONDITIONS

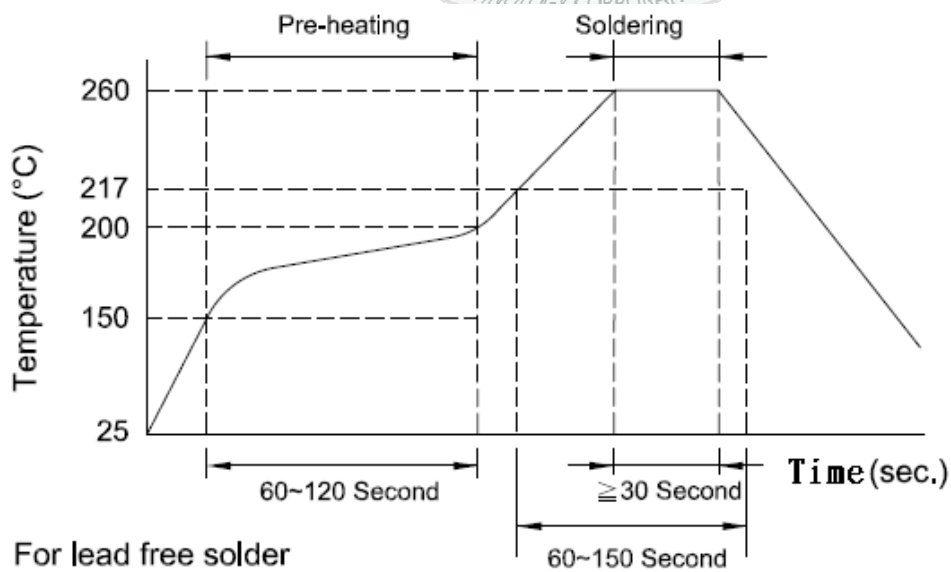

Impedance Frequency Characteristics(Typical)-0603

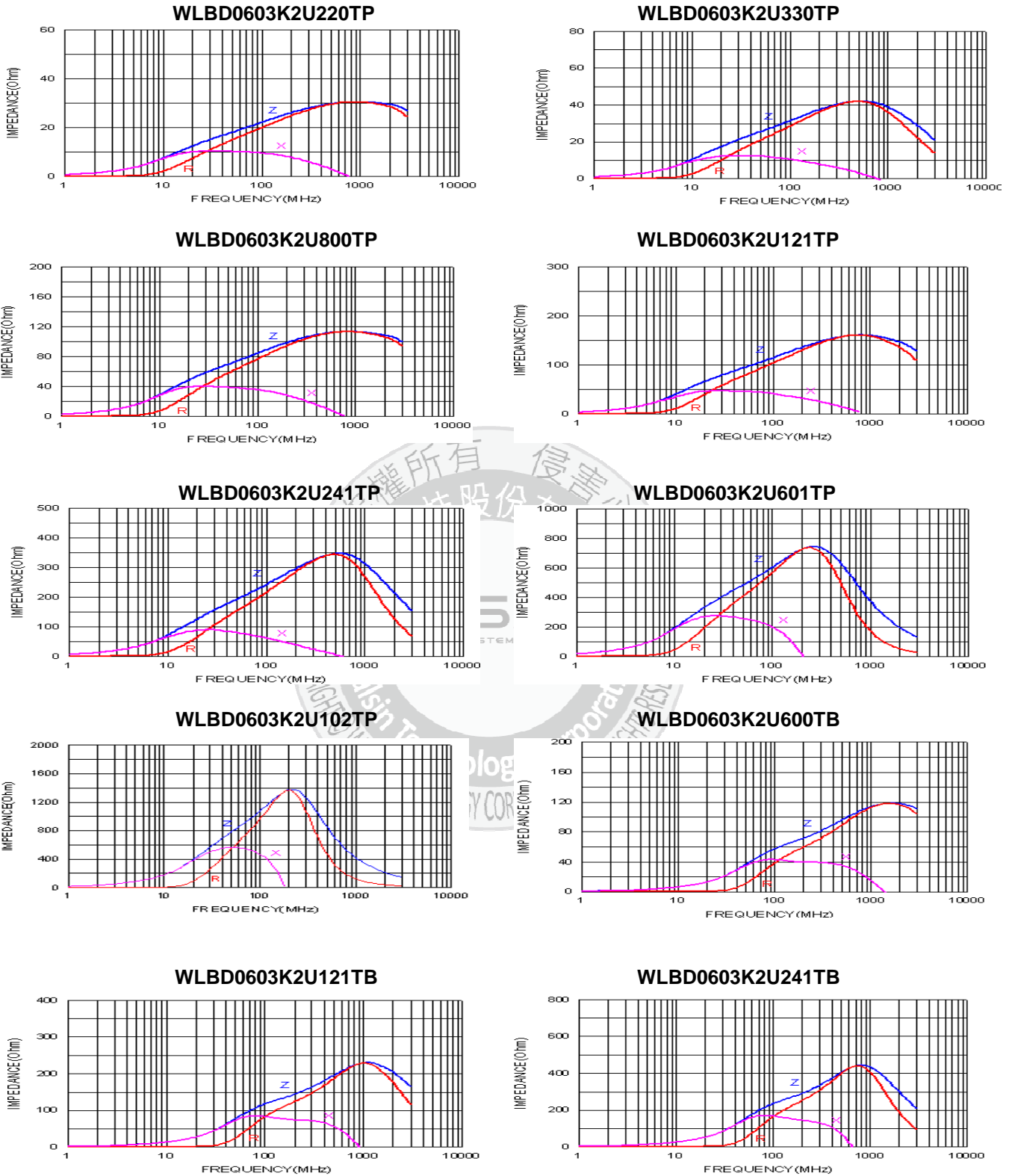



Impedance Frequency Characteristics(Typical)-1005

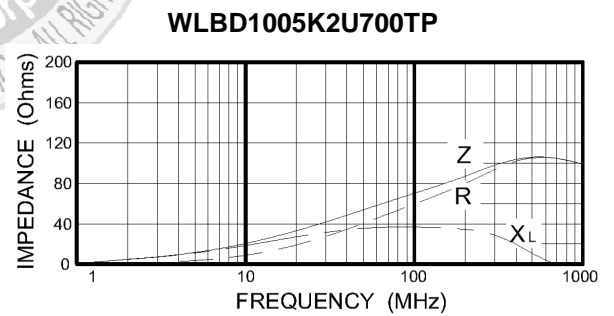
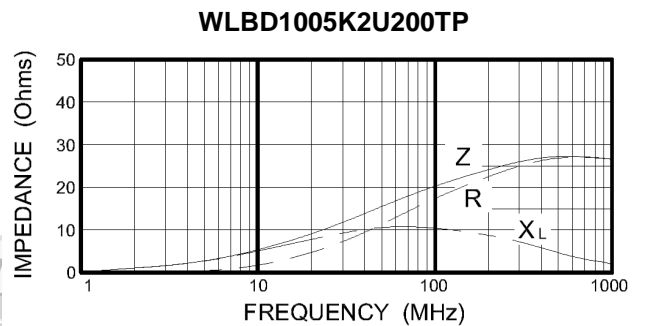
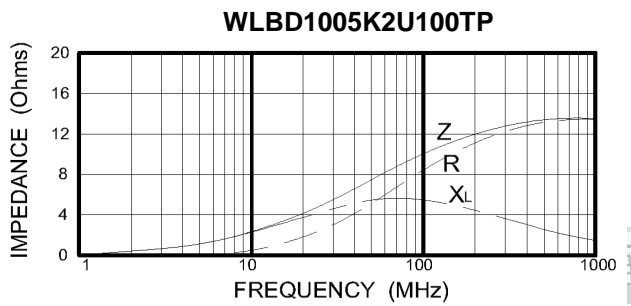

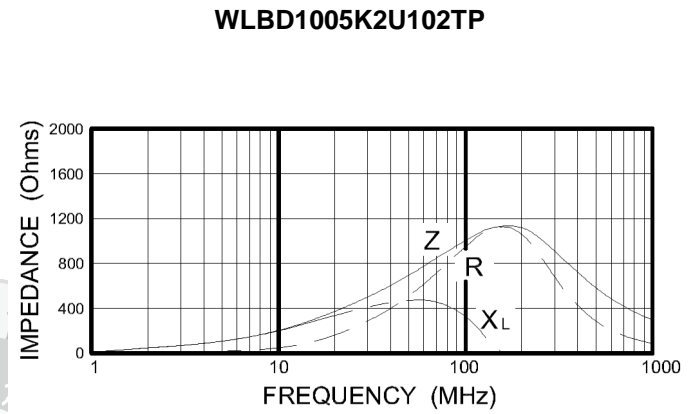
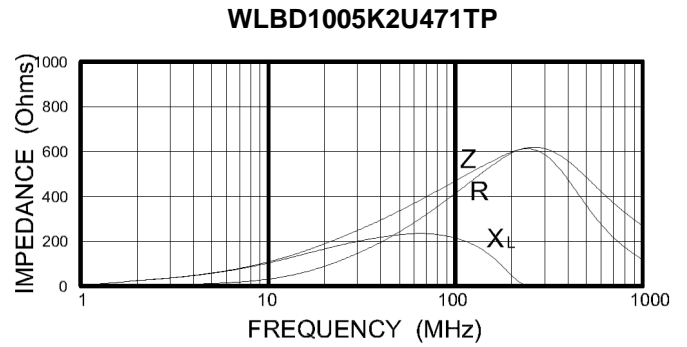

Impedance Frequency Characteristics(Typical)-1608

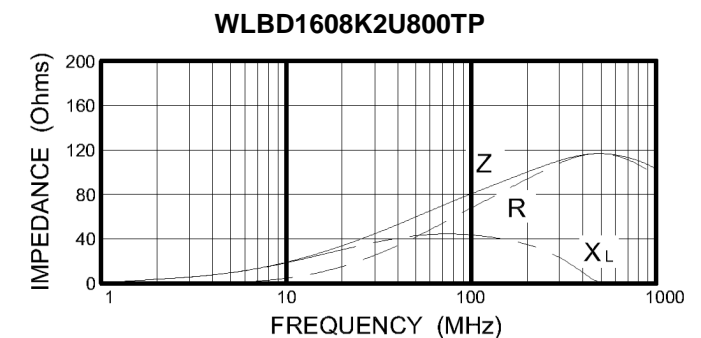
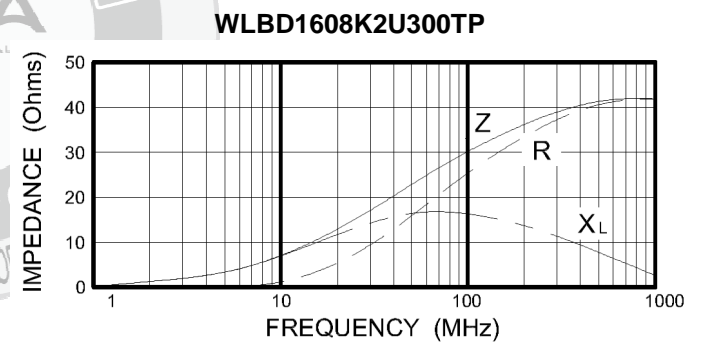

WLBD1608K2U100TP

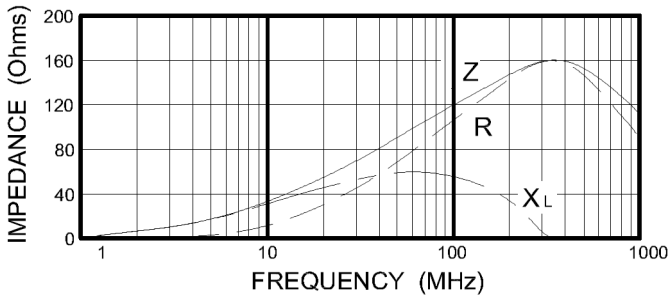

WLBD1608K2U181TP

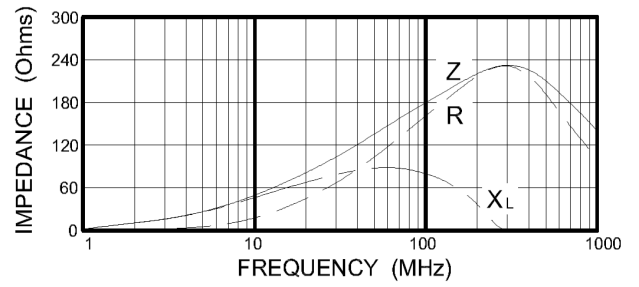

WLBD1608K2U221TP



WLBD1608K2U301TP

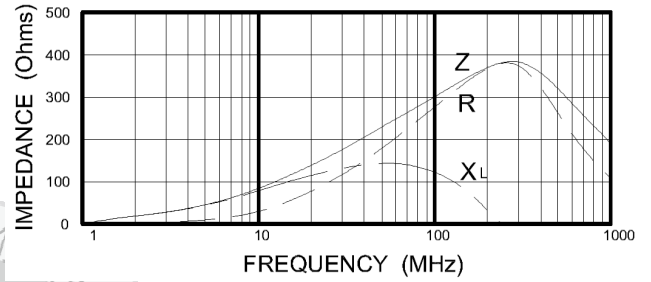

WLBD1608K2U331TP



WLBD1608K2U471TP

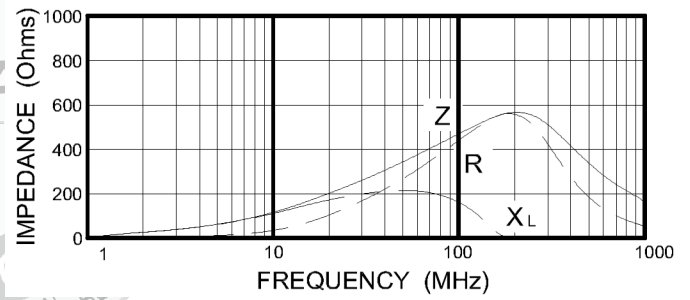

WLBD1608K2U601TP

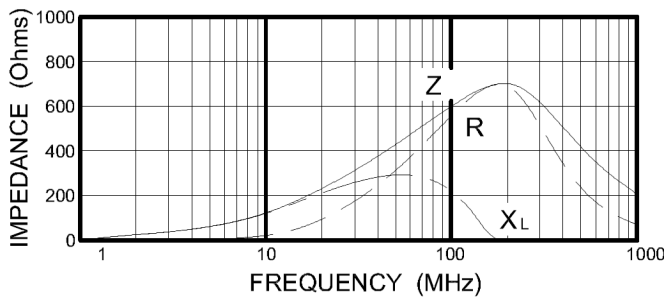

WLBD1608K2U102TP

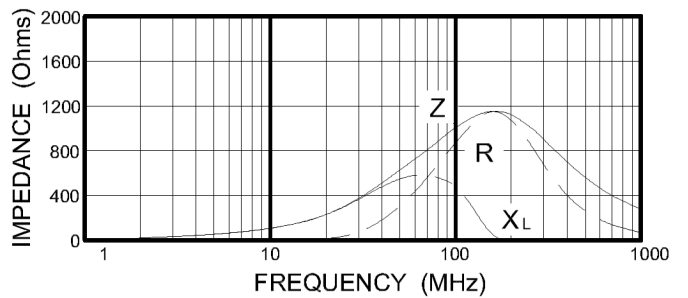

WLBD1608K2U182TP



WLBD1608K2U252TP

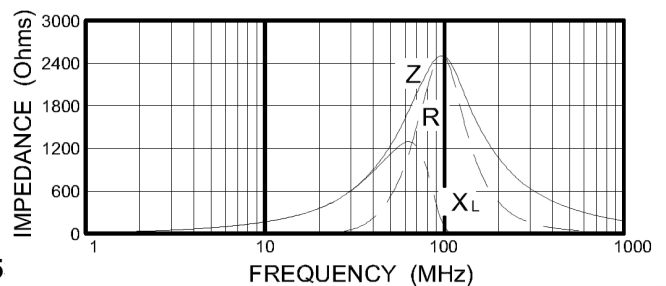

F

WLBD1608K2U252TB



Impedance Frequency Characteristics(Typical)-2012

WLBD2012K2U300TP

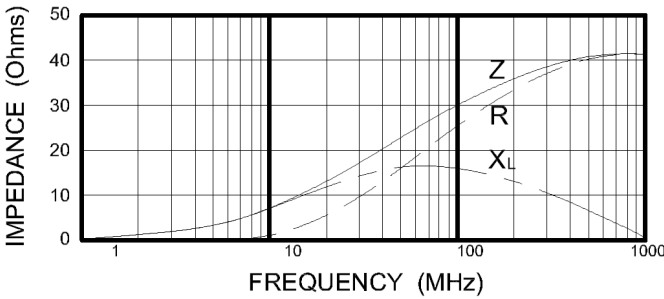

WLBD2012K2U400TP

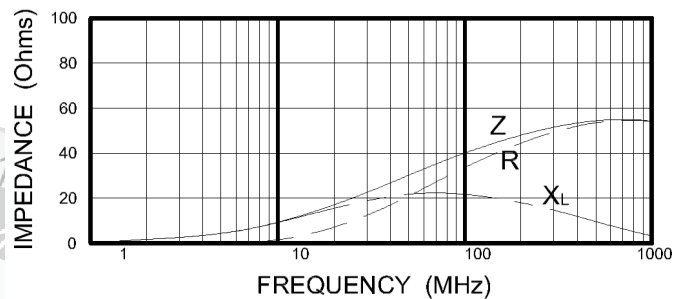

WLBD2012K2U600TP

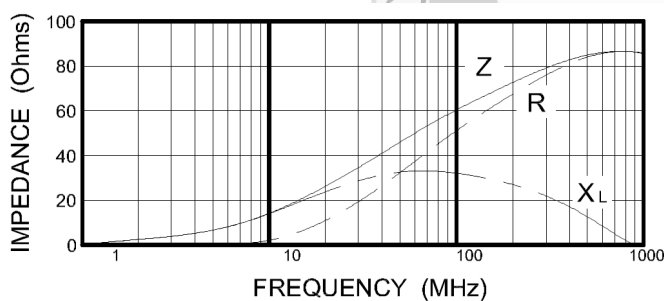

WLBD2012K2U800TP

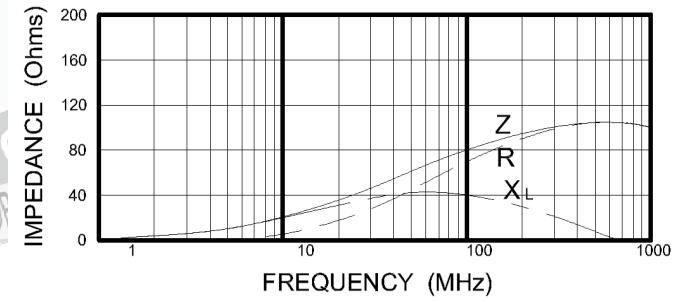

WLBD2012K2U121TP

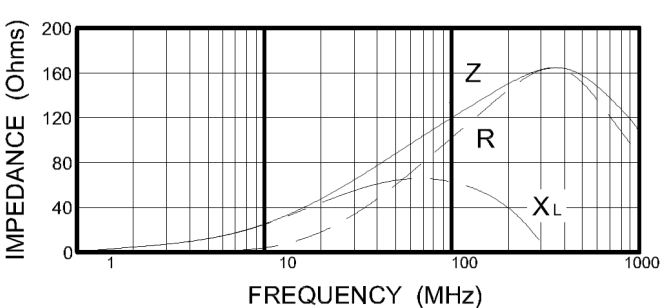

WLBD2012K2U221TP

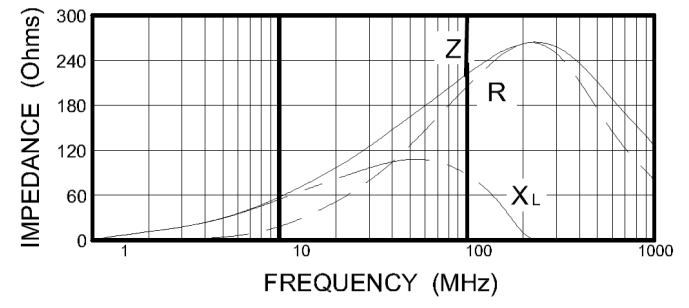



Impedance Frequency Characteristics(Typical)-3216

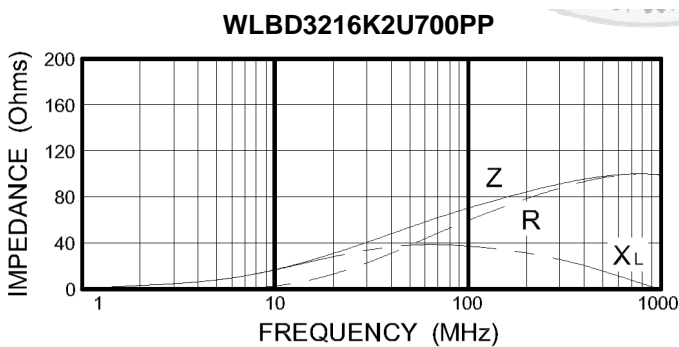
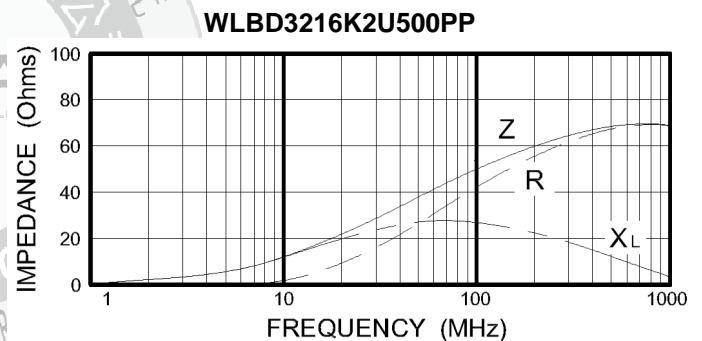
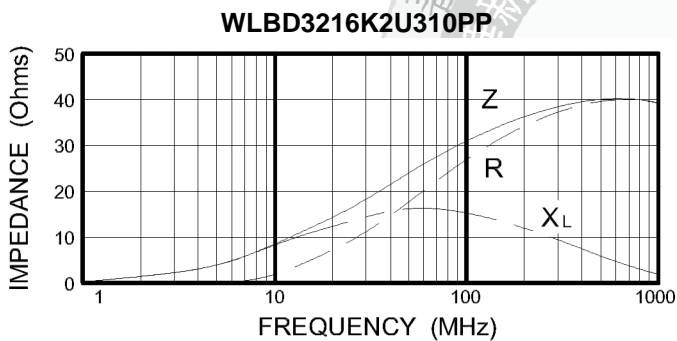

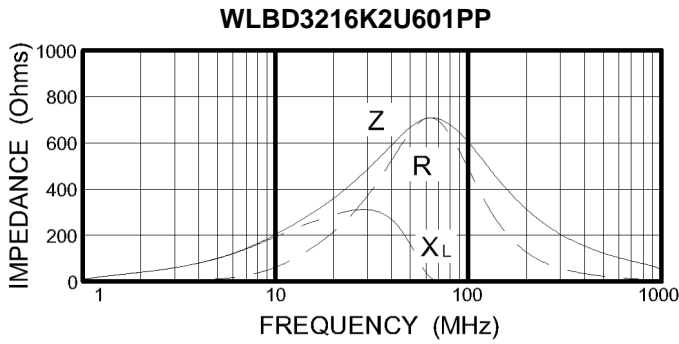

Impedance Frequency Characteristics(Typical)-3225

