

# APPROVAL SHEET

## **WLBD1608 Chip Bead**

\*Contents in this sheet are subject to change without prior notice.

## FEATURES

1. Closed magnetic circuit.

## APPLICATIONS

1. Noise reduction for general signal and DC line for General electronic circuits. Ex:PCs、Networking and Consumer electronics.

## SHAPE and DIMENSION

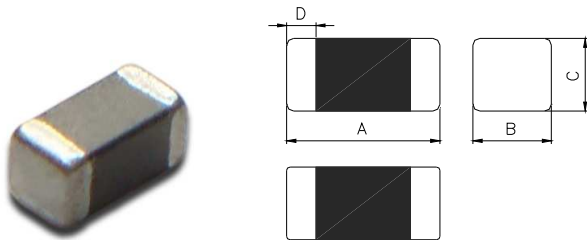

Chip Size	
<b>A</b>	1.60±0.15
<b>B</b>	0.80±0.15
<b>C</b>	0.80±0.15
<b>D</b>	0.30±0.20

Units: mm

## Ordering Information

WL	BD	1608	K1	U	300	T	B
<b>Product Code</b> WL: Inductor	<b>Series</b> BD: Chip Bead.	<b>Dimensions</b> 1.6 * 0.8 mm 1608 :EIA 0603	<b>Series extension</b> Refer to characteristic	<b>Tolerance</b> U: ±25%	<b>Value</b> 300 =30 OHM 301 =300 OHM 152 =1500 OHM	<b>Packing Code</b> T = 7" Paper Tape	<b>B:STD</b>

## Electrical Characteristics

### ● WLBD1608 series

Walsin Part Number	Impedance ( $\Omega$ )	Test Frequency (MHz)	DC Resistance ( $\Omega$ ) max.	Rated Current (mA) max.
WLBD1608K1U300TB	30 $\pm$ 25%	100	0.20	700
WLBD1608K1U600TB	60 $\pm$ 25%	100	0.20	700
WLBD1608K1U800TB	80 $\pm$ 25%	100	0.20	700
WLBD1608K1U121TB	120 $\pm$ 25%	100	0.25	600
WLBD1608K1U151TB	150 $\pm$ 25%	100	0.25	600
WLBD1608K1U221TB	220 $\pm$ 25%	100	0.30	550
WLBD1608K1U301TB	300 $\pm$ 25%	100	0.35	500
WLBD1608K1U471TB	470 $\pm$ 25%	100	0.45	350
WLBD1608K1U601TB	600 $\pm$ 25%	100	0.50	350
WLBD1608K1U102TB	1000 $\pm$ 25%	100	0.70	200
WLBD1608H1U152TB	1500 $\pm$ 25%	100	1.00	200
WLBD1608H1U202TB	2000 $\pm$ 25%	100	1.20	150

**Characteristic Curve**

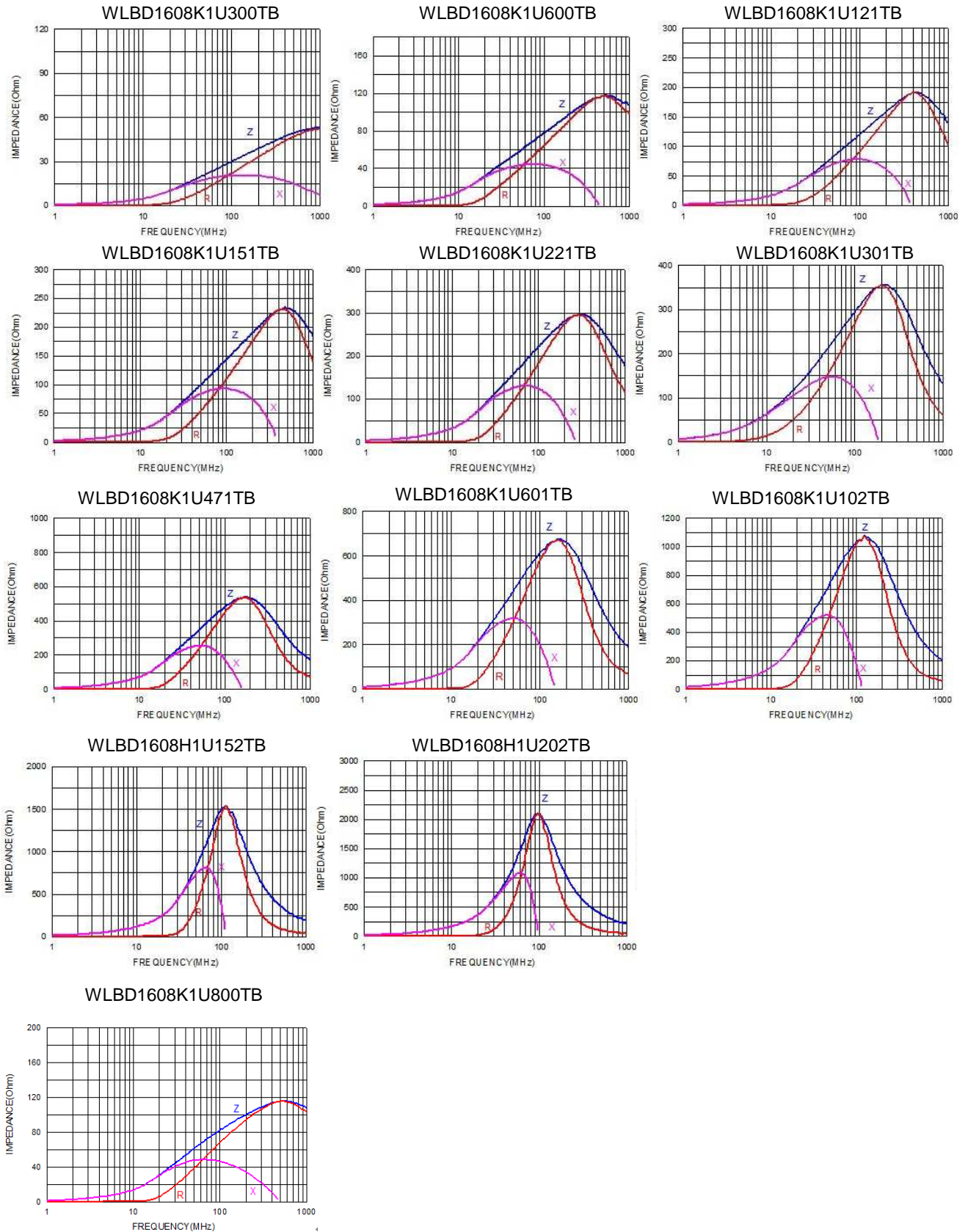

Test condition & Requirements

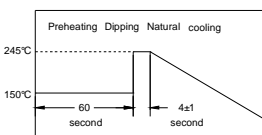
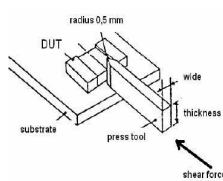
Item	Performance	Test Condition															
Operating Temperature	-40~+125°C (Including self-temperature rise)	--															
Transportation Storage Temperature	-40~+125°C (on board)	For long storage conditions, please see the Application Notice															
Impedance (Z)	Refer to standard electrical characteristics list	Agilent4291															
Inductance (Ls)		Agilent E4991															
Q Factor		Agilent4287															
DC Resistance		Agilent16192															
Rated Current		Agilent 4338															
Temperature Rise Test	Rated Current < 1A ΔT 20°C Max Rated Current ≥ 1A ΔT 40°C Max	1. Applied the allowed DC current. 2. Temperature measured by digital surface thermometer.															
Resistance to Soldering Heat	Appearance : No damage. Impedance : within±15% of initial value Inductance : within±10% of initial value Q : Shall not exceed the specification value. RDC : within ±15% of initial value and shall not exceed the specification value	Number of heat cycles: 1 <table border="1"><thead><tr><th>Temperature (°C)</th><th>Time (s)</th><th>Temperature ramp/immersion and emersion rate</th></tr></thead><tbody><tr><td>260 ±5 (solder temp)</td><td>10 ±1</td><td>25mm/s ±6 mm/s</td></tr></tbody></table> Depth: completely cover the termination	Temperature (°C)	Time (s)	Temperature ramp/immersion and emersion rate	260 ±5 (solder temp)	10 ±1	25mm/s ±6 mm/s									
Temperature (°C)	Time (s)	Temperature ramp/immersion and emersion rate															
260 ±5 (solder temp)	10 ±1	25mm/s ±6 mm/s															
Solderability	More than 95% of the terminal electrode should be covered with solder. 	Preheat: 150°C, 60sec. Solder: Sn96.5%-Ag3%-Cu0.5% Solder temperature: 245±5°C Flux for lead free: Rosin. 9.5% Depth: completely cover the termination. Dip time: 4±1sec.															
Terminal strength	Appearance : No damage. Impedance : within±15% of initial value Inductance : within±10% of initial value Q : Shall not exceed the specification value. RDC : within ±15% of initial value and shall not exceed the specification value 	Preconditioning: Run through IR reflow for 2 times.( IPC/JEDEC J-STD-020D Classification Reflow Profiles) Component mounted on a PCB apply a force (>0805:1kg <=0805:0.5kg)to the side of a device being tested. This force shall be applied for 60 +1 seconds. Also the force shall be applied gradually as not to shock the component being tested.															
Bending	Appearance : No damage. Impedance : within±10% of initial value Inductance : within±10% of initial value Q : Shall not exceed the specification value. RDC : within ±15% of initial value and shall not exceed the specification value	Shall be mounted on a FR4 substrate of the following dimensions:>=0805:40x100x1.2mm <0805:40x100x0.8mm Bending depth:>=0805:1.2mm <0805:0.8mm Duration of 10 sec for a min.															
Vibration Test	Appearance : No damage. Impedance : within±15% of initial value Inductance : within±10% of initial value Q : Shall not exceed the specification value. RDC : within ±15% of initial value and shall not exceed the specification value	Preconditioning: Run through IR reflow for 2 times.( IPC/JEDEC J-STD-020D Classification Reflow Profiles) Oscillation Frequency: 10~2K~10Hz for 20 minutes Equipment : Vibration checker Total Amplitude:1.52mm±10% Testing Time : 12 hours(20 minutes, 12 cycles each of 3 orientations) °															
Shock	Appearance : No damage. Impedance : within±10% of initial value Inductance : within±10% of initial value Q : Shall not exceed the specification value. RDC : within ±15% of initial value and shall not exceed the specification value	Test condition: <table border="1"><thead><tr><th>Type</th><th>Peak Value (g's)</th><th>Normal duration (D) (ms)</th><th>Wave form</th><th>Velocity change (V)ft/sec</th></tr></thead><tbody><tr><td>SMD</td><td>50</td><td>11</td><td>Half-sine</td><td>11.3</td></tr><tr><td>Lead</td><td>50</td><td>11</td><td>Half-sine</td><td>11.3</td></tr></tbody></table>	Type	Peak Value (g's)	Normal duration (D) (ms)	Wave form	Velocity change (V)ft/sec	SMD	50	11	Half-sine	11.3	Lead	50	11	Half-sine	11.3
Type	Peak Value (g's)	Normal duration (D) (ms)	Wave form	Velocity change (V)ft/sec													
SMD	50	11	Half-sine	11.3													
Lead	50	11	Half-sine	11.3													

Item	Performance	Test Condition
Life test	Appearance: no damage.  Impedance: within±15%of initial value. Inductance: within±10%of initial value. Q : Shall not exceed the specification value. RDC : within ±15% of initial value and shall not exceed the specification value	Preconditioning: Run through IR reflow for 2 times.( IPC/JEDEC J-STD-020D Classification Reflow Profiles) Temperature: 125±2°C (bead), 105±2°C (Inductor) Applied current: rated current. Duration: 1000±12hrs. Measured at room temperature after placing for 24±2 hrs.
Load Humidity		Preconditioning: Run through IR reflow for 2 times.( IPC/JEDEC J-STD-020D Classification Reflow Profiles) Humidity: 85±2%R.H. Temperature: 85±2°C. Duration: 1000hrs Min. with 100% rated current. Measured at room temperature after placing for 24±2 hrs.
Thermal shock	Appearance: no damage.  Impedance: within±15%of initial value. Inductance: within±10%of initial value. Q : Shall not exceed the specification value. RDC : within ±15% of initial value and shall not exceed the specification value	Preconditioning: Run through IR reflow for 2 times.( IPC/JEDEC J-STD-020D Classification Reflow Profiles) Condition for 1 cycle Step1: -40±2°C 30±5 min. Step2: 25±2°C ≤0.5min Step3: +125±2°C 30±5min. (Bead) Step3: +105±2°C 30±5min. (Inductor) Number of cycles: 500 Measured at room temperature after placing for 24±2 hrs.
Insulation Resistance	IR>1GΩ	Chip Inductor Only Test Voltage:100±10%V for 30Sec.

**\*\*Derating Curve**

For the ferrite chip bead which withstanding current over 1.5A, as the operating temperature over 85°C, the derating current information is necessary to consider with. For the detail derating of current, please refer to the Derated Current vs. Operating Temperature curve.

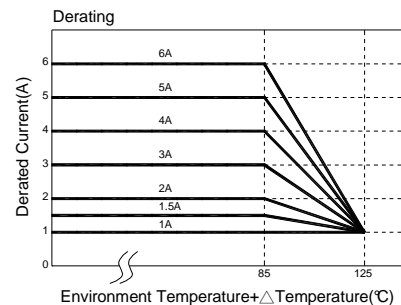

**Soldering and Mounting**

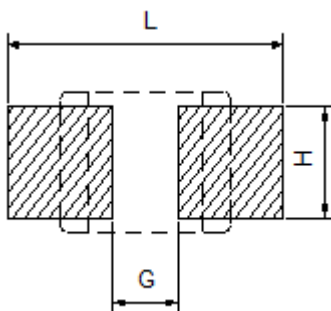

	L (mm)	G (mm)	H (mm)
<b>WLBD1608</b>	<b>2.6</b>	<b>0.6</b>	<b>0.8</b>

### Soldering

Mildly activated rosin fluxes are preferred. The terminations are suitable for re-flow soldering systems. If hand soldering cannot be avoided, the preferred technique is the utilization of hot air soldering tools.

Note. If wave soldering is used, there will be some risk.  
Re-flow soldering temperatures below 240 degrees, there will be non-wetting risk

### Lead Free Solder re-flow

Recommended temperature profiles for lead free re-flow soldering in Figure 1. (Referred to J-STD-020C)

### Soldering Iron:

Products attachment with a soldering iron is discouraged due to the inherent process control limitations. If a soldering iron must be employed the following precautions are recommended. for Iron Soldering in Figure 2.

- Preheat circuit and products to 150°C
- 350°C tip temperature (max)
- Never contact the ceramic with the iron tip
- 1.0mm tip diameter (max)
- Use a 20 watt soldering iron with tip diameter of 1.0mm
- Limit soldering time to 4-5sec.

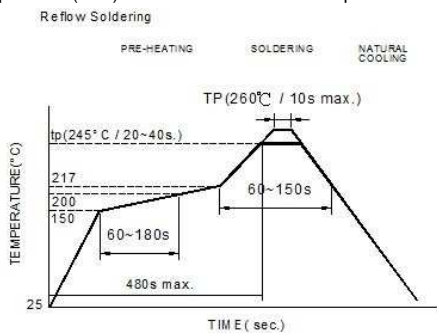

Reflow times: 3 times max.  
Fig. 1

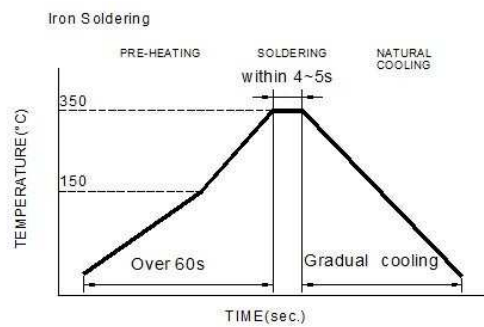

Iron Soldering times : 1 times max.  
Fig. 2

### Packaging Specification

#### Reel Dimension

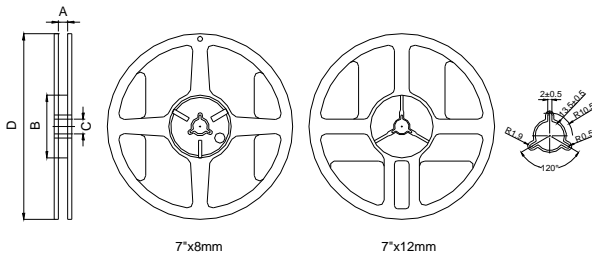

Type	A(mm)	B(mm)	C(mm)	D(mm)
7"x8mm	9.0±0.5	60±2	13.5±0.5	178±2
7"x12mm	13.5±0.5	60±2	13.5±0.5	178±2

#### Tape Dimension / 8mm

■Material of taping is paper

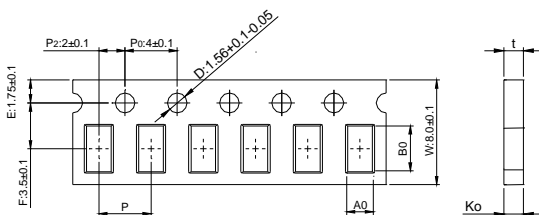

Size	Bo(mm)	Ao(mm)	Ko(mm)	P(mm)	t(mm)
WLBD1608	1.80±0.05	0.96+0.05/-0.03	0.95±0.05	4.0±0.10	0.95±0.05