

APPROVAL SHEET

WLBD2012HC **High Current Chip Bead**

*Contents in this sheet are subject to change without prior notice.

FEATURES

1. Closed magnetic circuit.
2. High current

APPLICATIONS

1. Noise reduction for general signal and DC line for General electronic circuits. Ex:PCs、Networking and Consumer electronics.

SHAPE and DIMENSION

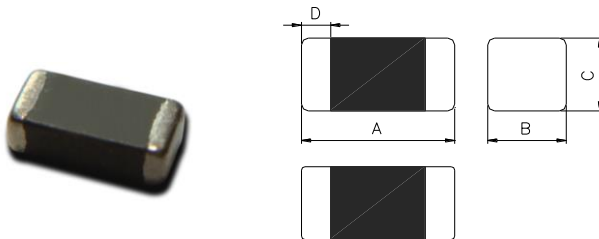

Chip Size	
A	2.00±0.20
B	1.25±0.20
C	0.85±0.20
D	0.50±0.30

Units: mm

Ordering Information

WL	BD	2012	HC	U	300	T	B
Product Code	Series	Dimensions	Series extension	Tolerance	Value	Packing Code	
WL: Inductor	BD :Chip Bead.	2.0 * 1.2 mm 2012 :EIA 0805	HC: High Current. Refer to characteristic	U: ±25%	300 =30 OHM 301 =300 OHM	T = 7" Paper Tape	B:STD

Electrical Characteristics

● WLBD2012HC series

Walsin Part Number	Impedance (Ω)	Test Frequency (MHz)	DC Resistance (Ω) max.	Rated Current (mA) max.
WLBD2012HCU300TB	30 \pm 25%	100	0.04	3000
WLBD2012HCU600TB	60 \pm 25%	100	0.04	3000
WLBD2012HCU700TB	70 \pm 25%	100	0.04	3000
WLBD2012HCU800TB	80 \pm 25%	100	0.04	3000
WLBD2012HCU121TB	120 \pm 25%	100	0.10	2000
WLBD2012HCU151TB	150 \pm 25%	100	0.10	2000
WLBD2012HCU221TB	220 \pm 25%	100	0.10	2000
WLBD2012HCU301TB	300 \pm 25%	100	0.20	1000
WLBD2012HCU471TB	470 \pm 25%	100	0.20	1000
WLBD2012HCU601TB	600 \pm 25%	100	0.20	1000

Characteristic Curve

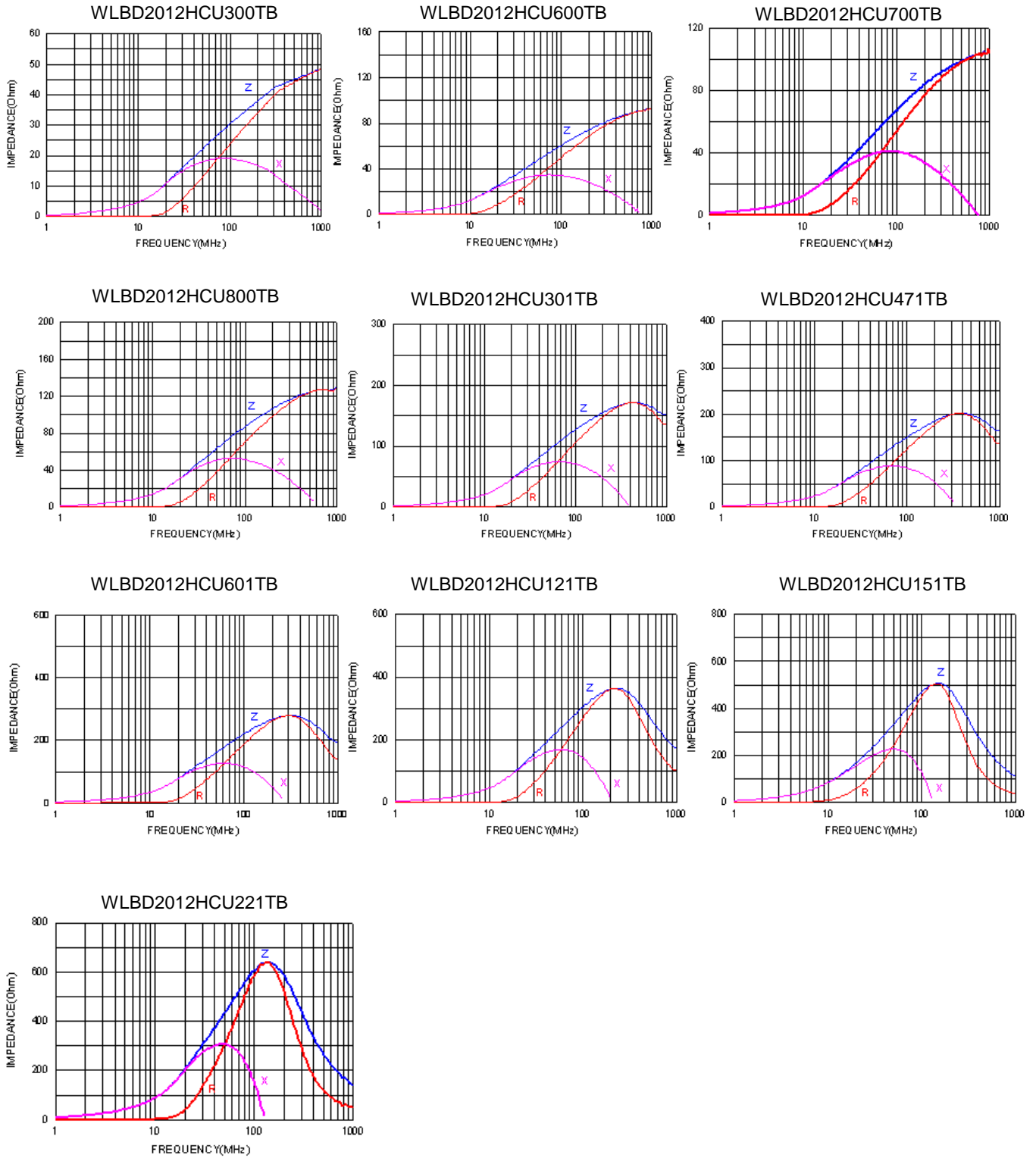

Test condition & Requirements

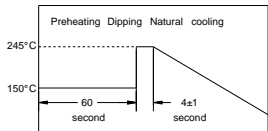
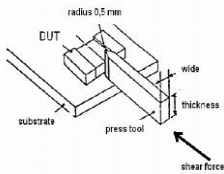
Item	Performance	Test Condition															
Operating Temperature	-40~+125°C (Including self-temperature rise)	--															
Transportation Storage Temperature	-40~+125°C (on board)	For long storage conditions, please see the Application Notice															
Impedance (Z)	Refer to standard electrical characteristics list	Agilent4291															
Inductance (Ls)		Agilent E4991															
Q Factor		Agilent4287															
DC Resistance		Agilent16192															
Rated Current		Agilent 4338															
Temperature Rise Test	Rated Current < 1A ΔT 20°C Max Rated Current ≥ 1A ΔT 40°C Max	1. Applied the allowed DC current. 2. Temperature measured by digital surface thermometer.															
Resistance to Soldering Heat	Appearance : No damage. Impedance : within±15% of initial value Inductance : within±10% of initial value Q : Shall not exceed the specification value. RDC : within ±15% of initial value and shall not exceed the specification value	Number of heat cycles: 1 <table border="1"> <thead> <tr> <th>Temperature (°C)</th> <th>Time (s)</th> <th>Temperature ramp/immersion and emersion rate</th> </tr> </thead> <tbody> <tr> <td>260 ±5 (solder temp)</td> <td>10 ±1</td> <td>25mm/s ±6 mm/s</td> </tr> </tbody> </table> Depth: completely cover the termination	Temperature (°C)	Time (s)	Temperature ramp/immersion and emersion rate	260 ±5 (solder temp)	10 ±1	25mm/s ±6 mm/s									
Temperature (°C)	Time (s)	Temperature ramp/immersion and emersion rate															
260 ±5 (solder temp)	10 ±1	25mm/s ±6 mm/s															
Solderability	More than 95% of the terminal electrode should be covered with solder. 	Steam Aging: 8 hours ± 15 min Preheat: 150°C, 60sec. Solder: Sn96.5%-Ag3%-Cu0.5% Solder temperature : 245±5°C Flux for lead free: Rosin. 9.5% Dip time: 4±1sec. Depth: completely cover the termination															
Terminal strength	Appearance : No damage. Impedance : within±15% of initial value Inductance : within±10% of initial value Q : Shall not exceed the specification value. RDC : within ±15% of initial value and shall not exceed the specification value 	Preconditioning: Run through IR reflow for 2 times.(IPC/JEDEC J-STD-020D Classification Reflow Profiles) Component mounted on a PCB apply a force (>0805:1kg <=0805:0.5kg)to the side of a device being tested. This force shall be applied for 60 +1 seconds. Also the force shall be applied gradually as not to shock the component being tested.															
Bending	Appearance : No damage. Impedance : within±10% of initial value Inductance : within±10% of initial value Q : Shall not exceed the specification value. RDC : within ±15% of initial value and shall not exceed the specification value	Shall be mounted on a FR4 substrate of the following dimensions:>=0805:40x100x1.2mm <0805:40x100x0.8mm Bending depth:>=0805:1.2mm <0805:0.8mm Duration of 10 sec for a min.															
Vibration Test	Appearance : No damage. Impedance : within±15% of initial value Inductance : within±10% of initial value Q : Shall not exceed the specification value. RDC : within ±15% of initial value and shall not exceed the specification value	Preconditioning: Run through IR reflow for 2 times.(IPC/JEDEC J-STD-020D Classification Reflow Profiles) Oscillation Frequency: 10~2K~10Hz for 20 minutes Equipment : Vibration checker Total Amplitude:1.52mm±10% Testing Time : 12 hours(20 minutes, 12 cycles each of 3 orientations) °															
Shock	Appearance : No damage. Impedance : within±10% of initial value Inductance : within±10% of initial value Q : Shall not exceed the specification value. RDC : within ±15% of initial value and shall not exceed the specification value	Test condition: <table border="1"> <thead> <tr> <th>Type</th> <th>Peak Value (g's)</th> <th>Normal duration (D) (ms)</th> <th>Wave form</th> <th>Velocity change (V)ft/sec</th> </tr> </thead> <tbody> <tr> <td>SMD</td> <td>50</td> <td>11</td> <td>Half-sine</td> <td>11.3</td> </tr> <tr> <td>Lead</td> <td>50</td> <td>11</td> <td>Half-sine</td> <td>11.3</td> </tr> </tbody> </table>	Type	Peak Value (g's)	Normal duration (D) (ms)	Wave form	Velocity change (V)ft/sec	SMD	50	11	Half-sine	11.3	Lead	50	11	Half-sine	11.3
Type	Peak Value (g's)	Normal duration (D) (ms)	Wave form	Velocity change (V)ft/sec													
SMD	50	11	Half-sine	11.3													
Lead	50	11	Half-sine	11.3													

Item	Performance	Test Condition
Life test	Appearance: no damage.	Preconditioning: Run through IR reflow for 2 times.(IPC/JEDEC J-STD-020D Classification Reflow Profiles) Temperature: 125±2°C (bead), 105±2°C (Inductor) Applied current: rated current. Duration: 1000±12hrs. Measured at room temperature after placing for 24±2 hrs.
Load Humidity	Impedance: within±15%of initial value. Inductance: within±10%of initial value. Q : Shall not exceed the specification value. RDC : within ±15% of initial value and shall not exceed the specification value	Preconditioning: Run through IR reflow for 2 times.(IPC/JEDEC J-STD-020D Classification Reflow Profiles) Humidity: 85±2%R.H. Temperature: 85±2°C . Duration: 1000hrs Min. with 100% rated current. Measured at room temperature after placing for 24±2 hrs.
Thermal shock	Appearance: no damage. Impedance: within±15%of initial value. Inductance: within±10%of initial value. Q : Shall not exceed the specification value. RDC : within ±15% of initial value and shall not exceed the specification value	Preconditioning: Run through IR reflow for 2 times.(IPC/JEDEC J-STD-020D Classification Reflow Profiles) Condition for 1 cycle Step1: -40±2°C 30±5 min. Step2: 25±2°C ≤0.5min Step3: +125±2°C 30±5min. (Bead) Step3: +105±2°C 30±5min. (Inductor) Number of cycles: 500 Measured at room temperature after placing for 24±2 hrs.

****Derating Curve**

For the ferrite chip bead which withstanding current over 1.5A, as the operating temperature over 85°C, the derating current information is necessary to consider with. For the detail derating of current, please refer to the Derated Current vs. Operating Temperature curve.

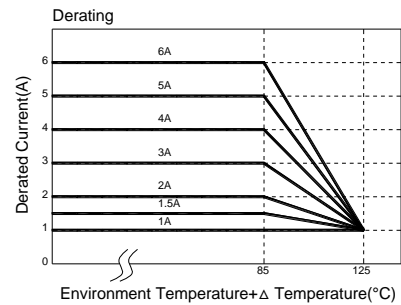

Soldering and Mounting

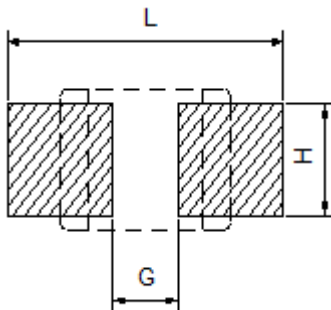

	L (mm)	G (mm)	H (mm)
WLBD2012HC	3.00	1.00	1.00

Approval sheet

Soldering

Mildly activated rosin fluxes are preferred. The terminations are suitable for re-flow soldering systems. If hand soldering cannot be avoided, the preferred technique is the utilization of hot air soldering tools.

Note. If wave soldering is used, there will be some risk.
Re-flow soldering temperatures below 240 degrees, there will be non-wetting risk

Lead Free Solder re-flow

Recommended temperature profiles for lead free re-flow soldering in Figure 1. (Referred to J-STD-020C)

Soldering Iron:

Products attachment with a soldering iron is discouraged due to the inherent process control limitations. If a soldering iron must be employed the following precautions are recommended. for Iron Soldering in Figure 2.

- Preheat circuit and products to 150°C
- 350°C tip temperature (max)
- Never contact the ceramic with the iron tip
- 1.0mm tip diameter (max)
- Use a 20 watt soldering iron with tip diameter of 1.0mm
- Limit soldering time to 4~5sec.

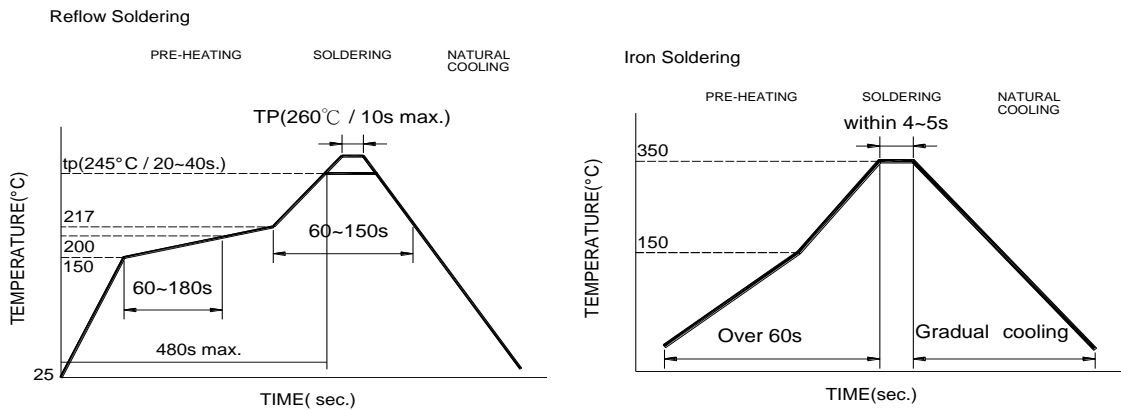

Packaging Specification

Reel Dimension

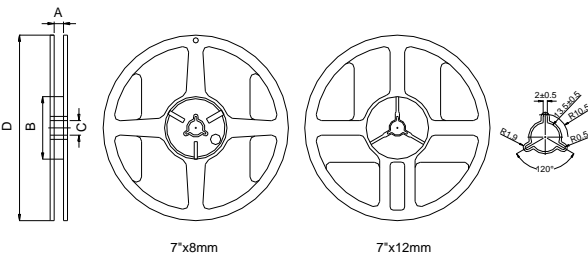

Type	A(mm)	B(mm)	C(mm)	D(mm)
7"x8mm	9.0±0.5	60±2	13.5±0.5	178±2
7"x12mm	13.5±0.5	60±2	13.5±0.5	178±2

Tape Dimension / 8mm

■Material of taping is paper

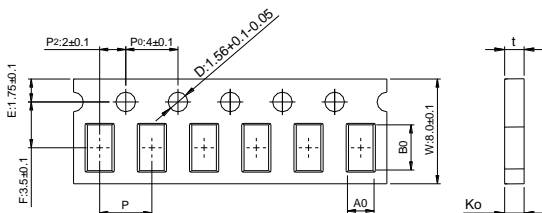

Size	Bo(mm)	Ao(mm)	Ko(mm)	P(mm)	t(mm)
WLBD2012HC	2.10±0.05	1.30±0.05	0.95±0.05	4.0±0.10	0.95±0.05