

APPROVAL SHEET

WLBD2012HC High Current Chip Bead

*Contents in this sheet are subject to change without prior notice.

FEATURES

1. Closed magnetic circuit.
2. High current

APPLICATIONS

1. Noise reduction for general signal and DC line for General electronic circuits. Ex:PCs、Networking and Consumer electronics.

SHAPE and DIMENSION

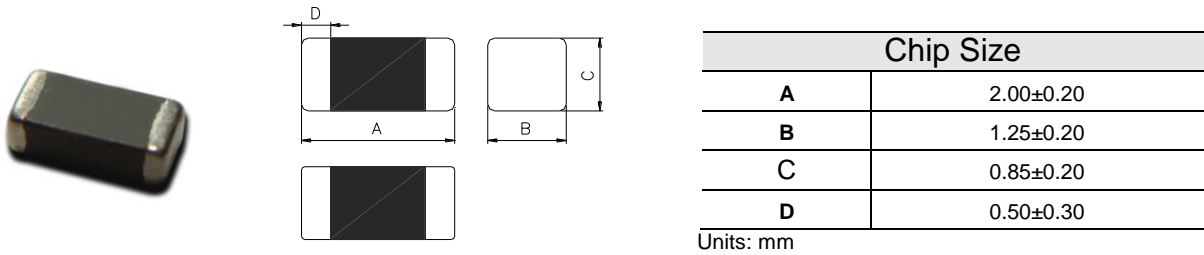

Ordering Information

| WL | BD | 2012 | HC | U | 300 | T | B |
|---------------------|----------------|--------------------------------|--|------------------|-----------------------------|----------------------|-------|
| Product Code | Series | Dimensions | Series extension | Tolerance | Value | Packing Code | |
| WL: Inductor | BD :Chip Bead. | 2.0 * 1.2 mm 2012 :EIA 0805 | HC: High Current. Refer to characteristic | U: ±25% | 300 =30 OHM 301 =300 OHM | T = 7" Paper Tape | B:STD |

Electrical Characteristics

● WLBD2012HC series

| Walsin Part Number | Impedance (Ω) | Test Frequency (MHz) | DC Resistance (Ω) max. | Rated Current (mA) max. |
|--------------------|------------------------|----------------------|---------------------------------|-------------------------|
| WLBD2012HCU300TB | 30 \pm 25% | 100 | 0.04 | 3000 |
| WLBD2012HCU600TB | 60 \pm 25% | 100 | 0.04 | 3000 |
| WLBD2012HCU700TB | 70 \pm 25% | 100 | 0.04 | 3000 |
| WLBD2012HCU800TB | 80 \pm 25% | 100 | 0.04 | 3000 |
| WLBD2012HCU121TB | 120 \pm 25% | 100 | 0.10 | 2000 |
| WLBD2012HCU151TB | 150 \pm 25% | 100 | 0.10 | 2000 |
| WLBD2012HCU221TB | 220 \pm 25% | 100 | 0.10 | 2000 |
| WLBD2012HCU301TB | 300 \pm 25% | 100 | 0.20 | 1000 |
| WLBD2012HCU471TB | 470 \pm 25% | 100 | 0.20 | 1000 |
| WLBD2012HCU601TB | 600 \pm 25% | 100 | 0.20 | 1000 |

Characteristic Curve

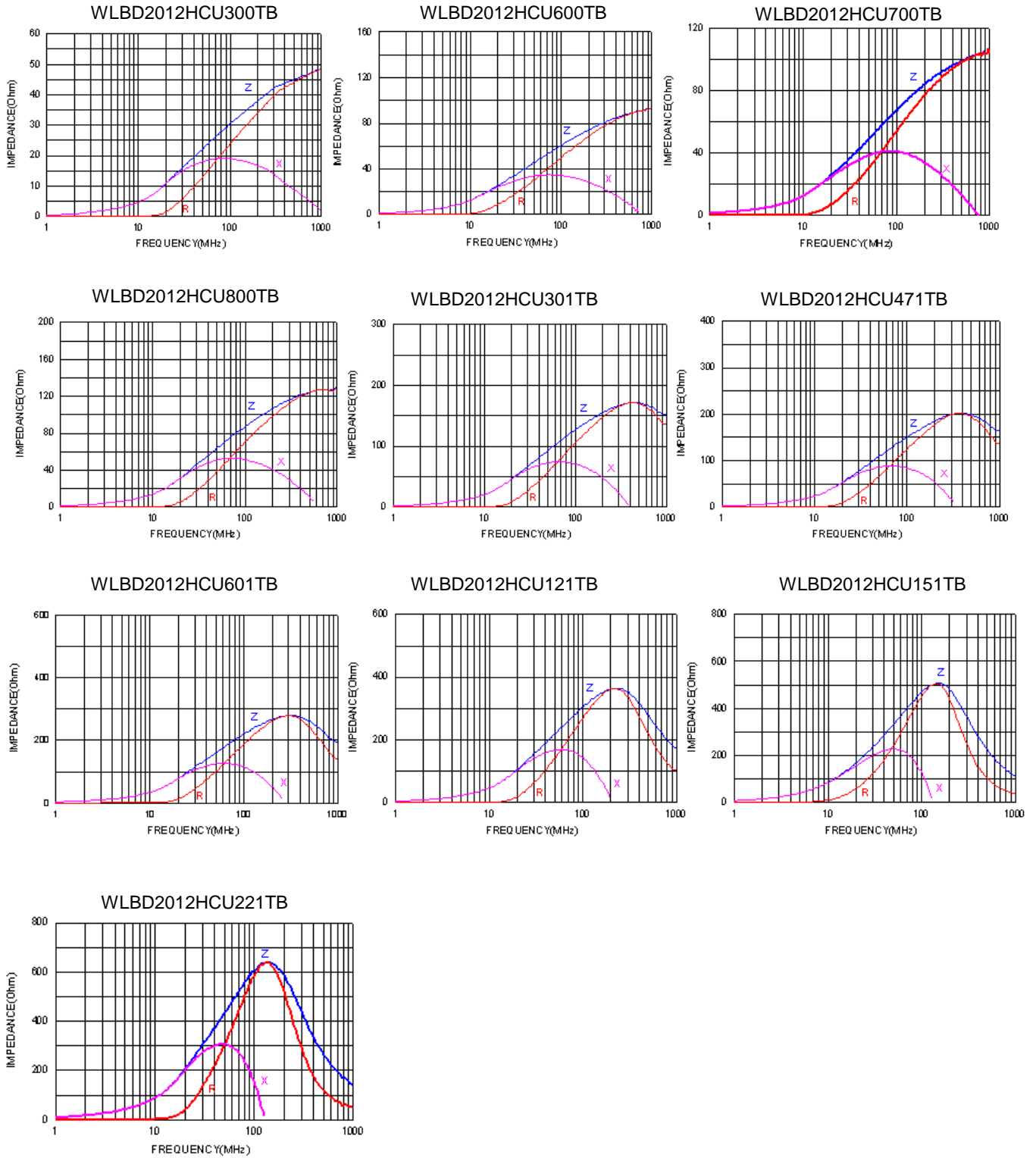

Test condition & Requirements

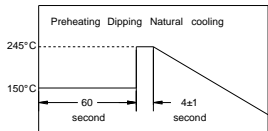
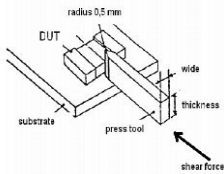
| Item | Performance | Test Condition | | | | | | | | | | | | | | | |
|------------------------------------|--|---|------------------|----------------------------|--|----------------------|----------------------------|----------------|----|----|-----------|------|------|----|----|-----------|------|
| Operating Temperature | -40~+125°C (Including self-temperature rise) | -- | | | | | | | | | | | | | | | |
| Transportation Storage Temperature | -40~+125°C (on board) | For long storage conditions, please see the Application Notice | | | | | | | | | | | | | | | |
| Impedance (Z) | Refer to standard electrical characteristics list | Agilent4291 | | | | | | | | | | | | | | | |
| Inductance (Ls) | | Agilent E4991 | | | | | | | | | | | | | | | |
| Q Factor | | Agilent4287 | | | | | | | | | | | | | | | |
| DC Resistance | | Agilent16192 | | | | | | | | | | | | | | | |
| Rated Current | | Agilent 4338 | | | | | | | | | | | | | | | |
| Temperature Rise Test | Rated Current < 1A ΔT 20°C Max Rated Current ≥ 1A ΔT 40°C Max | 1. Applied the allowed DC current. 2. Temperature measured by digital surface thermometer. | | | | | | | | | | | | | | | |
| Resistance to Soldering Heat | Appearance : No damage. Impedance : within±15% of initial value Inductance : within±10% of initial value Q : Shall not exceed the specification value. RDC : within ±15% of initial value and shall not exceed the specification value | Number of heat cycles: 1 <table border="1"> <thead> <tr> <th>Temperature (°C)</th> <th>Time (s)</th> <th>Temperature ramp/immersion and emersion rate</th> </tr> </thead> <tbody> <tr> <td>260 ±5 (solder temp)</td> <td>10 ±1</td> <td>25mm/s ±6 mm/s</td> </tr> </tbody> </table> Depth: completely cover the termination | Temperature (°C) | Time (s) | Temperature ramp/immersion and emersion rate | 260 ±5 (solder temp) | 10 ±1 | 25mm/s ±6 mm/s | | | | | | | | | |
| Temperature (°C) | Time (s) | Temperature ramp/immersion and emersion rate | | | | | | | | | | | | | | | |
| 260 ±5 (solder temp) | 10 ±1 | 25mm/s ±6 mm/s | | | | | | | | | | | | | | | |
| Solderability | More than 95% of the terminal electrode should be covered with solder.  | Steam Aging: 8 hours ± 15 min Preheat: 150°C, 60sec. Solder: Sn96.5%-Ag3%-Cu0.5% Solder temperature : 245±5°C Flux for lead free: Rosin. 9.5% Dip time: 4±1sec. Depth: completely cover the termination | | | | | | | | | | | | | | | |
| Terminal strength | Appearance : No damage. Impedance : within±15% of initial value Inductance : within±10% of initial value Q : Shall not exceed the specification value. RDC : within ±15% of initial value and shall not exceed the specification value  | Preconditioning: Run through IR reflow for 2 times.(IPC/JEDEC J-STD-020D Classification Reflow Profiles) Component mounted on a PCB apply a force (>0805:1kg <=0805:0.5kg)to the side of a device being tested. This force shall be applied for 60 +1 seconds. Also the force shall be applied gradually as not to shock the component being tested. | | | | | | | | | | | | | | | |
| Bending | Appearance : No damage. Impedance : within±10% of initial value Inductance : within±10% of initial value Q : Shall not exceed the specification value. RDC : within ±15% of initial value and shall not exceed the specification value | Shall be mounted on a FR4 substrate of the following dimensions:>=0805:40x100x1.2mm <0805:40x100x0.8mm Bending depth:>=0805:1.2mm <0805:0.8mm Duration of 10 sec for a min. | | | | | | | | | | | | | | | |
| Vibration Test | Appearance : No damage. Impedance : within±15% of initial value Inductance : within±10% of initial value Q : Shall not exceed the specification value. RDC : within ±15% of initial value and shall not exceed the specification value | Preconditioning: Run through IR reflow for 2 times.(IPC/JEDEC J-STD-020D Classification Reflow Profiles) Oscillation Frequency: 10~2K~10Hz for 20 minutes Equipment : Vibration checker Total Amplitude:1.52mm±10% Testing Time : 12 hours(20 minutes, 12 cycles each of 3 orientations) ° | | | | | | | | | | | | | | | |
| Shock | Appearance : No damage. Impedance : within±10% of initial value Inductance : within±10% of initial value Q : Shall not exceed the specification value. RDC : within ±15% of initial value and shall not exceed the specification value | Test condition: <table border="1"> <thead> <tr> <th>Type</th> <th>Peak Value (g's)</th> <th>Normal duration (D) (ms)</th> <th>Wave form</th> <th>Velocity change (Vi)ft/sec</th> </tr> </thead> <tbody> <tr> <td>SMD</td> <td>50</td> <td>11</td> <td>Half-sine</td> <td>11.3</td> </tr> <tr> <td>Lead</td> <td>50</td> <td>11</td> <td>Half-sine</td> <td>11.3</td> </tr> </tbody> </table> | Type | Peak Value (g's) | Normal duration (D) (ms) | Wave form | Velocity change (Vi)ft/sec | SMD | 50 | 11 | Half-sine | 11.3 | Lead | 50 | 11 | Half-sine | 11.3 |
| Type | Peak Value (g's) | Normal duration (D) (ms) | Wave form | Velocity change (Vi)ft/sec | | | | | | | | | | | | | |
| SMD | 50 | 11 | Half-sine | 11.3 | | | | | | | | | | | | | |
| Lead | 50 | 11 | Half-sine | 11.3 | | | | | | | | | | | | | |

| Item | Performance | Test Condition |
|---------------|---|--|
| Life test | Appearance: no damage. | Preconditioning: Run through IR reflow for 2 times.(IPC/JEDEC J-STD-020D Classification Reflow Profiles) Temperature: 125±2°C (bead), 105±2°C (Inductor) Applied current: rated current. Duration: 1000±12hrs. Measured at room temperature after placing for 24±2 hrs. |
| Load Humidity | Impedance: within±15%of initial value. Inductance: within±10%of initial value. Q : Shall not exceed the specification value. RDC : within ±15% of initial value and shall not exceed the specification value | Preconditioning: Run through IR reflow for 2 times.(IPC/JEDEC J-STD-020D Classification Reflow Profiles) Humidity: 85±2%R.H. Temperature: 85±2°C . Duration: 1000hrs Min. with 100% rated current. Measured at room temperature after placing for 24±2 hrs. |
| Thermal shock | Appearance: no damage. Impedance: within±15%of initial value. Inductance: within±10%of initial value. Q : Shall not exceed the specification value. RDC : within ±15% of initial value and shall not exceed the specification value | Preconditioning: Run through IR reflow for 2 times.(IPC/JEDEC J-STD-020D Classification Reflow Profiles) Condition for 1 cycle Step1: -40±2°C 30±5 min. Step2: 25±2°C ≤0.5min Step3: +125±2°C 30±5min. (Bead) Step3: +105±2°C 30±5min. (Inductor) Number of cycles: 500 Measured at room temperature after placing for 24±2 hrs. |

****Derating Curve**

For the ferrite chip bead which withstanding current over 1.5A, as the operating temperature over 85°C, the derating current information is necessary to consider with. For the detail derating of current, please refer to the Derated Current vs. Operating Temperature curve.

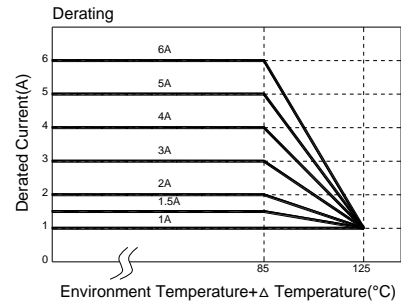

Soldering and Mounting

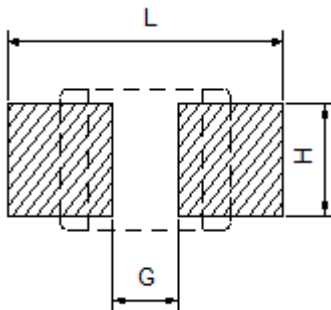

| | L (mm) | G (mm) | H (mm) |
|-------------------|-------------|-------------|-------------|
| WLBD2012HC | 3.00 | 1.00 | 1.00 |

Approval sheet

Soldering

Mildly activated rosin fluxes are preferred. The terminations are suitable for re-flow soldering systems. If hand soldering cannot be avoided, the preferred technique is the utilization of hot air soldering tools.

Note. If wave soldering is used, there will be some risk.
Re-flow soldering temperatures below 240 degrees, there will be non-wetting risk

Lead Free Solder re-flow

Recommended temperature profiles for lead free re-flow soldering in Figure 1. (Referred to J-STD-020C)

Soldering Iron:

Products attachment with a soldering iron is discouraged due to the inherent process control limitations. If a soldering iron must be employed the following precautions are recommended. for Iron Soldering in Figure 2.

- Preheat circuit and products to 150°C
- 350°C tip temperature (max)
- Never contact the ceramic with the iron tip
- 1.0mm tip diameter (max)
- Use a 20 watt soldering iron with tip diameter of 1.0mm
- Limit soldering time to 4~5sec.

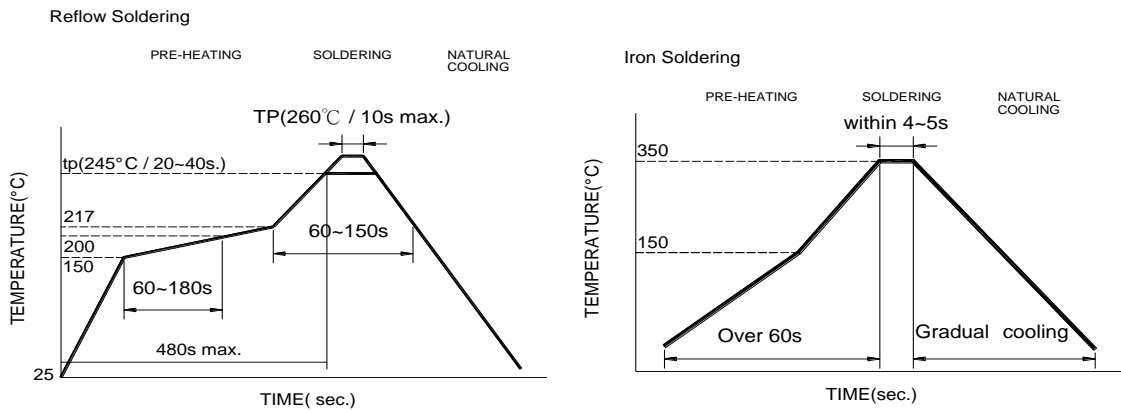

Packaging Specification

Reel Dimension

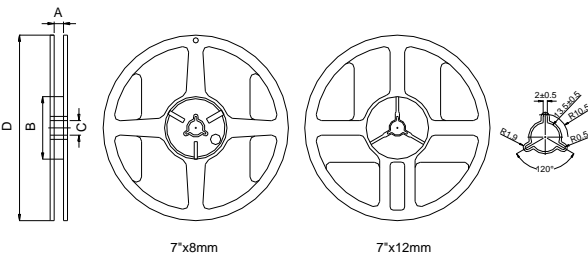

| Type | A(mm) | B(mm) | C(mm) | D(mm) |
|---------|----------|-------|----------|-------|
| 7"x8mm | 9.0±0.5 | 60±2 | 13.5±0.5 | 178±2 |
| 7"x12mm | 13.5±0.5 | 60±2 | 13.5±0.5 | 178±2 |

Tape Dimension / 8mm

■Material of taping is paper

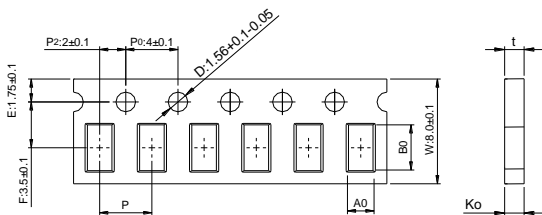

| Size | Bo(mm) | Ao(mm) | Ko(mm) | P(mm) | t(mm) |
|------------|-----------|-----------|-----------|----------|-----------|
| WLBD2012HC | 2.10±0.05 | 1.30±0.05 | 0.95±0.05 | 4.0±0.10 | 0.95±0.05 |