

# APPROVAL SHEET

**WLBD0603 - 4532**

**Chip Bead**

**General Series**



\*Contents in this sheet are subject to change without prior notice.

## FEATURES

1. Monolithic inorganic material construction.
2. Closed magnetic circuit avoids crosstalk.
3. S.M.T. type.
4. Suitable for reflow soldering.
5. Shapes and dimensions follow E.I.A. spec.
6. Available in various sizes.
7. Excellent solder ability and heat resistance.

## SHAPE and DIMENSION

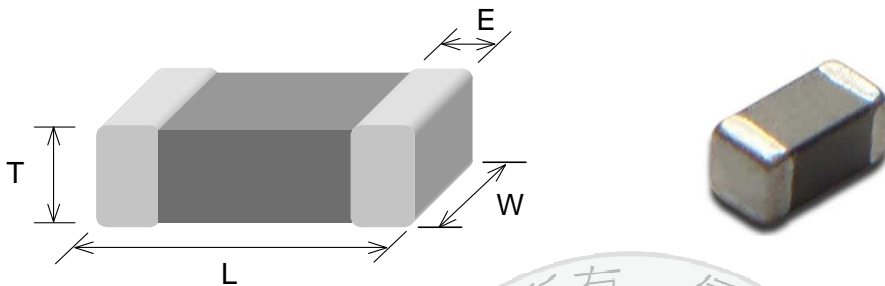

TYPE	0603 (EIA 0201)	1005 (EIA 0402)	1608 (EIA 0603)	2012 (EIA 0805)	3216 (EIA 1206)	3225 (EIA 1210)	4516 (EIA 1806)	4532 (EIA 1812)
L	0.60±0.03	1.00±0.10	1.60±0.15	2.00±0.20	3.20±0.20	3.20±0.20	4.50±0.25	4.50±0.25
W	0.30±0.03	0.50±0.10	0.80±0.15	1.25±0.20	1.60±0.20	2.50±0.20	1.60±0.20	3.20±0.25
T	0.30±0.03	0.50±0.10	0.80±0.15	0.90±0.20	1.10±0.20	1.30±0.20	1.60±0.20	1.50±0.25
E	0.15±0.05	0.25±0.10	0.30±0.20	0.50±0.30	0.50±0.30	0.50±0.30	0.60±0.40	0.60±0.40
Unit	mm							

## Ordering Information

WL	BD	0603 - 4532	K2	U	300	T/P	P/B
<b>Product Code</b> WL: Inductor	<b>Series</b> BD: Chip Bead.	<b>Dimensions</b>  <b>JIS: (EIA)</b> 0603 : (0201) 1005 : (0402) 1608: (0603) 2012: (0805) 3216: (1206) 3225: (1210) 4516: (1806) 4532: (1812)	<b>Series extension</b> Refer to characteristic	<b>Tolerance</b> U: ±25%	<b>Value</b> 300 =30 OHM 601 =600 OHM 102 =1000OHM	<b>Packing Code</b> T = 7" Paper Tape P = 7" Plastic Tape	<b>P/B/F/G</b> Internal code

## PART NUMBER AND CHARACTERISTICS TABLE

### WLBD0603 - 1005 series

Walsin Part Number	Impedance ( $\Omega$ ) +/-25%	Test Frequency (MHz)	DC Resistance ( $\Omega$ ) max.	Rated Current (mA) max.
WLBD0603K2U220TP	22	100	0.065	500
WLBD0603K2U330TP	33	100	0.07	500
WLBD0603K2U800TP	80	100	0.40	200
WLBD0603K2U121TP	120	100	0.50	200
WLBD0603K2U241TP	240	100	0.80	200
WLBD0603K2U601TP	600	100	1.20	150
WLBD0603K2U102TP	1000	100	1.15	200
WLBD0603K2U600TB	60	100	0.25	200
WLBD0603K2U121TB	120	100	0.40	250
WLBD0603K2U241TB	240	100	0.80	200
WLBD0603K2U471TB	470	100	1.05	220
WLBD0603K2U601TB	600	100	1.20	200
Walsin Part Number	Impedance ( $\Omega$ ) +/-25%	Test Frequency (MHz)	DC Resistance ( $\Omega$ ) max.	Rated Current (mA) max.
WLBD1005K2U100TP	10	100	0.10	300
WLBD1005K2U200TP	20	100	0.20	300
WLBD1005K2U300TP	30	100	0.25	300
WLBD1005K2U400TP	40	100	0.30	300
WLBD1005K2U600TP	60	100	0.35	300
WLBD1005K2U700TP	70	100	0.35	300
WLBD1005K2U121TP	120	100	0.40	300
WLBD1005K2U241TP	240	100	0.70	200
WLBD1005K2U301TP	300	100	0.80	200
WLBD1005K2U471TP	470	100	1.00	200
WLBD1005K2U601TP	600	100	1.00	300
WLBD1005K2U102TP	1000	100	1.50	200
WLBD1005K2U102TF	1000	100	1.50	300
WLBD1005K2U102TG	1000	100	0.7	400

## PART NUMBER AND CHARACTERISTICS TABLE

### WLBD1608 - 3216 series

Walsin Part Number	Impedance ( $\Omega$ ) +/-25%	Test Frequency (MHz)	DC Resistance ( $\Omega$ ) max.	Rated Current (mA) max.
WLBD1608K2U100TP	10	100	0.05	600
WLBD1608K2U300TP	30	100	0.08	600
WLBD1608K2U600TP	60	100	0.10	600
WLBD1608K2U800TP	80	100	0.10	600
WLBD1608K2U121TP	120	100	0.15	600
WLBD1608K2U181TP	180	100	0.30	300
WLBD1608K2U221TP	220	100	0.30	500
WLBD1608K2U301TP	300	100	0.35	500
WLBD1608K2U331TP	330	100	0.30	500
WLBD1608K2U471TP	470	100	0.40	300
WLBD1608K2U601TP	600	100	0.45	200
WLBD1608K2U102TP	1000	100	0.60	200
WLBD1608K2U152TP	1500	100	0.60	500
WLBD1608K2U182TP	1800	100	0.70	100
WLBD1608K2U252TP	2500	100	0.70	100
WLBD1608K2U252TB	2500	100	0.70	200
Walsin Part Number	Impedance ( $\Omega$ ) +/-25%	Test Frequency (MHz)	DC Resistance ( $\Omega$ ) max.	Rated Current (mA) max.
WLBD2012K2U300TP	30	100	0.05	800
WLBD2012K2U400TP	40	100	0.05	800
WLBD2012K2U600TP	60	100	0.15	800
WLBD2012K2U800TP	80	100	0.15	800
WLBD2012K2U121TP	120	100	0.15	800
WLBD2012K2U221TP	220	100	0.20	500
WLBD2012K2U301TP	300	100	0.20	500
WLBD2012K2U601TP	600	100	0.30	500
WLBD2012K2U102TP	1000	100	0.35	300
WLBD2012K2U202TP	2000	100	0.50	200
Walsin Part Number	Impedance ( $\Omega$ ) +/-25%	Test Frequency (MHz)	DC Resistance ( $\Omega$ ) max.	Rated Current (mA) max.
WLBD3216K2U310PP	31	100	0.05	800
WLBD3216K2U500PP	50	100	0.08	800
WLBD3216K2U700PP	70	100	0.10	800
WLBD3216K2U121PP	120	100	0.15	600
WLBD3216K2U601PP	600	100	0.30	500
WLBD3216K2U102PP	1000	100	0.40	500
WLBD3216K2U122PP	1200	100	0.40	500
WLBD3216K2U152PP	1500	50	0.50	200
WLBD3216K2U202PP	2000	30	0.50	200

**PART NUMBER AND CHARACTERISTICS TABLE**

WLBD3225 - 4532 series

Walsin Part Number	Impedance (Ω) +/-25%	Test Frequency (MHz)	DC Resistance (Ω) max.	Rated Current (mA) max.
WLBD3225K2U600PP	60	100	0.30	800
WLBD3225K2U900PP	90	100	0.30	800
Walsin Part Number	Impedance (Ω) +/-25%	Test Frequency (MHz)	DC Resistance (Ω) max.	Rated Current (mA) max.
WLBD4516K2U800PP	80	100	0.10	800
WLBD4516K2U151PP	150	100	0.30	800
Walsin Part Number	Impedance (Ω) +/-25%	Test Frequency (MHz)	DC Resistance (Ω) max.	Rated Current (mA) max.
WLBD4532K2U700PP	70	100	0.40	800
WLBD4532K2U800PP	80	100	0.40	800
WLBD4532K2U121PP	120	100	0.40	800
Test Level :	250 mV			
Test Instruments :	<ul style="list-style-type: none"> <li>•HP4291B RF IMPEDANCE / MATERIAL ANALYZER</li> <li>•HP4338A/B MILLIOHMMETER</li> <li>•Agilent 8720ES S-PARAMETER NETWORK ANALYZER</li> <li>•HP6632B SYSTEM DC POWER SUPPLY</li> </ul>			

Land Patterns for Reflow Soldering

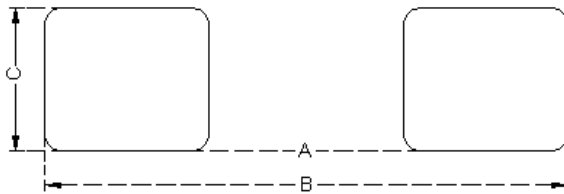

Solder Land Information

Unit: mm (inches)

Size	A	B	C
0603	10±1.5	50 or more	13±0.2
1005	0.4 (0.016)	1.2 ~1.4 (0.047 ~0.055)	0.5 (0.020)
1608	0.7 (0.028)	1.8~ 2.0 (0.071~ 0.079)	0.7 (0.028)
2012	1.2 (0.047)	3.0 ~4.0 (0.118 ~0.157)	1.0 (0.039)
3216	2.0 (0.079)	4.2 ~5.2 (0.165 ~0.205)	1.2 (0.047)
3225	2.0 (0.079)	4.2 ~5.2 (0.165 ~0.205)	3.4 (0.134)
4516	3.0 (0.118)	5.5~6.5 (0.217 ~0.256)	1.2 (0.047)
4532	3.0 (0.118)	5.5 ~6.5 (0.217 ~0.256)	4.22 (0.166)

## RELIABILITY AND TEST CONDITION

Test item	Test condition	Criteria
Temperature Cycle	Temperature : -40 ~ +125°C Cycle : 100 cycles Dwell time : 30minutes Measurement : at ambient temperature 24 hours after test completion	No mechanical damage Impedance value should be within $\pm 20\%$ of the initial value
Operational Life	Temperature : 125°C $\pm 5^\circ\text{C}$ Test time : 1000 hours Apply current : full rated current Measurement : at ambient temperature 24 hours after test completion	No mechanical damage Impedance value should be within $\pm 20\%$ of the initial value
Biased Humidity	Temperature : 40°C $\pm 2^\circ\text{C}$ Humidity : 90 ~ 95 % RH Test time : 1000 hours Apply current : full rated current Measurement : at ambient temperature 24 hours after test completion	No mechanical damage Impedance value should be within $\pm 20\%$ of the initial value
Resistance to Solder Heat	Solder temperature : 260 $\pm 5^\circ\text{C}$ Flux : Rosin DIP time : 10 $\pm 1$ sec	More than 95 % of terminal electrode should be covered with new solder No mechanical damage Impedance value should be within $\pm 20\%$ of the initial value
Adhesive Test	Reflow temperature : 245°C. It shall be Soldered on the substrate applying direction parallel to the substrate Apply force(F) : 5 N Test time : 10 sec	No mechanical damage Soldering the products on PCB after the pulling test force > 5 N
Steam Aging Test	Temperature : 93°C Test time : 4 hrs(WLCM1005) Others : 8 hours c. Solder temperature : 235 $\pm 5^\circ\text{C}$ Flux : Rosin e. DIP time : 5 $\pm 1$ sec	More than 95 % of terminal electrode should be covered with new solder
Rated Current Test	Apply current : full rated current / 5min	Temperature rise should be less than 25°C

## GENERAL TECHNICAL DATA

Operating temperature range : - 55°C ~ +125°C

Storage Condition : Less than 40°C and 70% RH

Storage Time: 6 months(Size:0603,1005)

12 months(Size:1608 above)

Soldering method: Reflow

**TAPE AND REEL SPECIFICATIONS**  
**PLASTIC CARRIER**

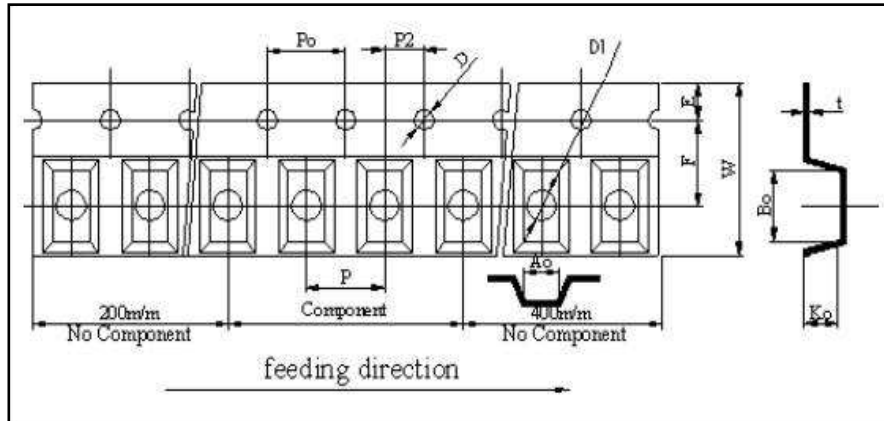

**PAPER CARRIER**

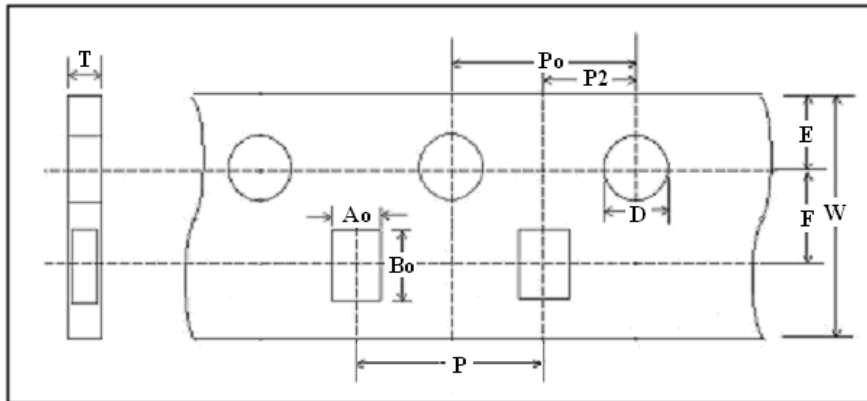

**Taping Dimensions**

Size	4532	4516	3225	3216	2012	1608	1005	0603
Symbol	PLASTIC	PLASTIC	PLASTIC	PLASTIC	PAPER	PAPER	PAPER	
W	12.0±0.10	11.7~12.3	7.70~8.30	7.90~8.30	8.00±0.10	8.00±0.10	8.00±0.10	
P	8.00±0.10	4.00±0.10	4.00±0.10	4.00±0.10	4.00±0.10	4.00±0.10	2.00±0.05	2.1±0.05
E	1.75±0.10	1.75±0.10	1.75±0.10	1.75±0.10	1.75±0.10	1.75±0.10	1.75±0.05	
F	5.50±0.05	5.50±0.05	3.50±0.05	3.50±0.05	3.50±0.10	3.50±0.10	3.50±0.05	
D	1.55±0.05	1.55±0.05	1.55±0.05	1.55±0.05	1.56±0.10	1.56±0.10	1.55±0.05	
D1	1.50~1.75	1.50~1.75	0.95~1.20	0.95~1.20	NA	NA	NA	
P <sub>0</sub>	4.00±0.10	4.00±0.10	4.00±0.10	4.00±0.10	4.00±0.10	4.00±0.10	4.00±0.10	
P <sub>010</sub>	40.0±0.20	40.0±0.20	40.0±0.20	40.0±0.20	40.0±0.20	NA	NA	
P <sub>2</sub>	2.00±0.05	2.00±0.05	2.00±0.05	2.00±0.05	2.00±0.10	2.00±0.10	2.00±0.05	
A <sub>0</sub>	3.66±0.10	1.83±0.10	2.57±0.10	1.85±0.10	1.50±0.05	1.05±0.05	0.62±0.03	0.40±0.06
B <sub>0</sub>	4.95±0.10	4.85±0.10	3.40±0.10	3.43±0.10	2.30±0.05	1.85±0.05	1.12±0.03	0.70±0.06
K <sub>0</sub> (T)	1.83±0.10	1.83±0.10	1.32±0.10	1.22±0.10	0.95±0.05	0.95±0.05	0.60±0.03	0.45max
t	0.23±0.10	0.29±0.10	0.25±0.10	0.25±0.10	NA	NA	NA	0.45max

**REEL DIMENSIONS**

Unit: mm

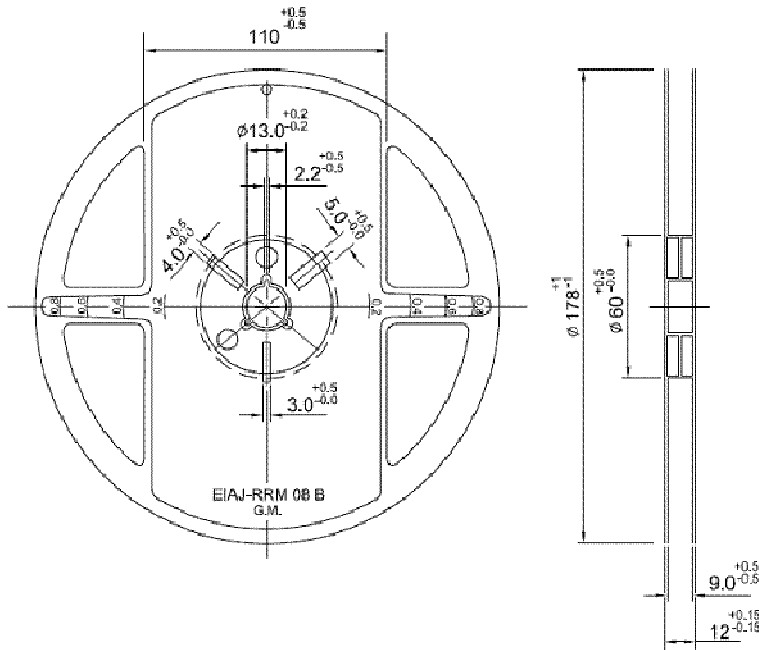

7" Reel Packaging Quantity								
PART SIZE (EIA SIZE)	<b>0603 (0201)</b>	<b>1005 (0402)</b>	<b>1608 (0603)</b>	<b>2012 (0805)</b>	<b>3216 (1206)</b>	<b>3225 (1210)</b>	<b>4516 (1806)</b>	<b>4532 (1812)</b>
Qty.(pcs)	15,000	10,000	4,000	4,000	3,000	2,000	2,000	1,000
BOX	5 reels / inner box						4 reels / inner box	

**RECOMMENDED SOLDERING CONDITIONS**

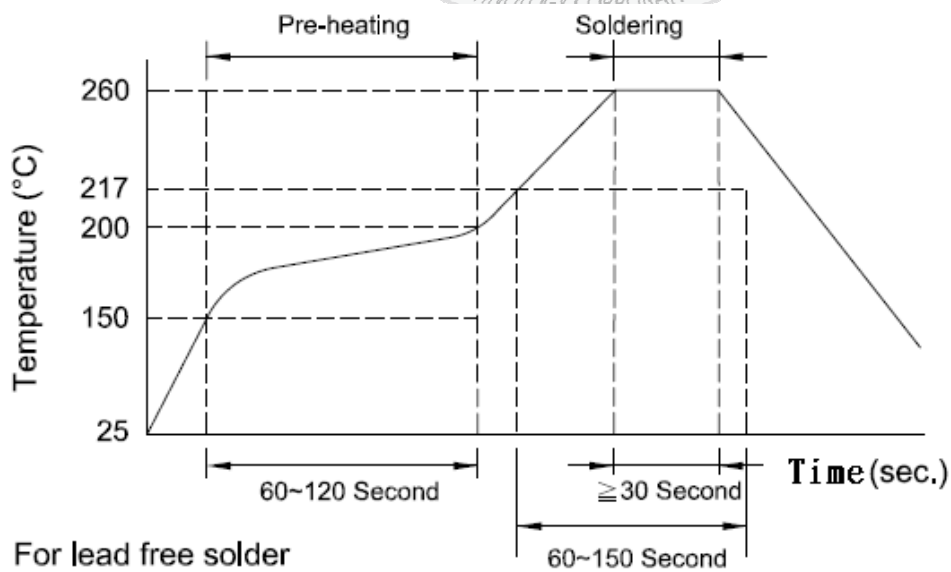



# Impedance Frequency Characteristics(Typical)-0603

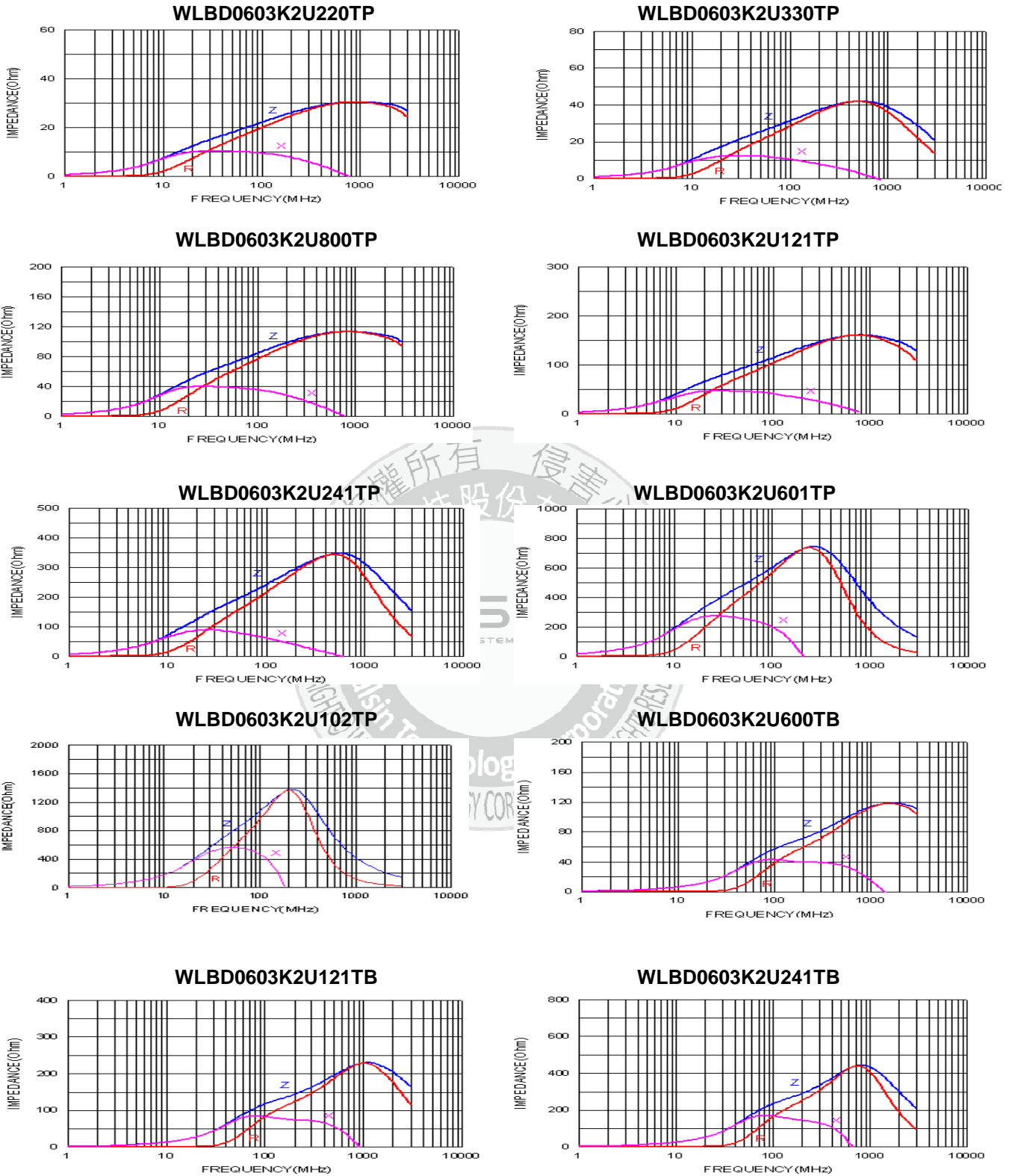

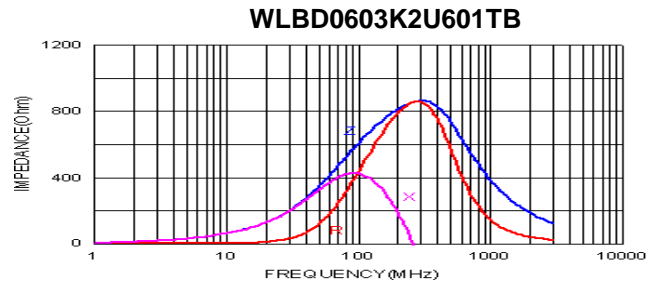
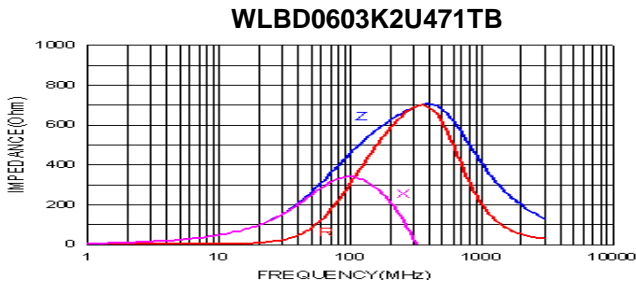

## Impedance Frequency Characteristics(Typical)-1005

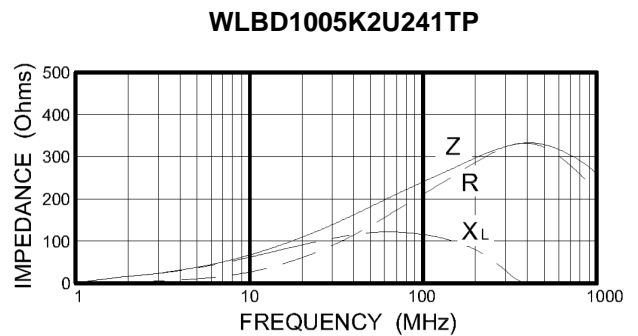
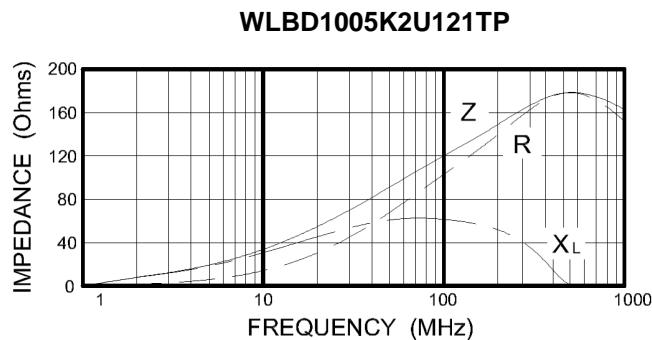
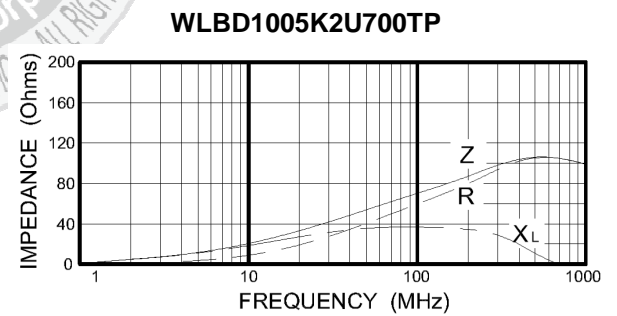
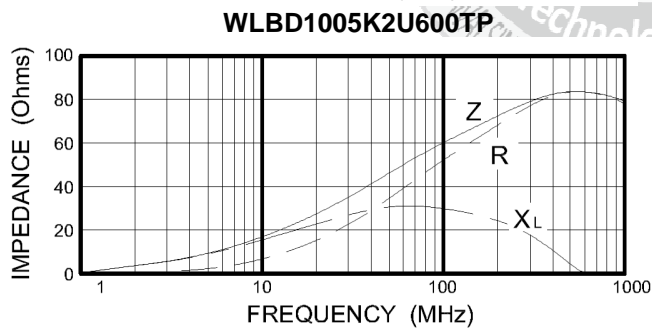
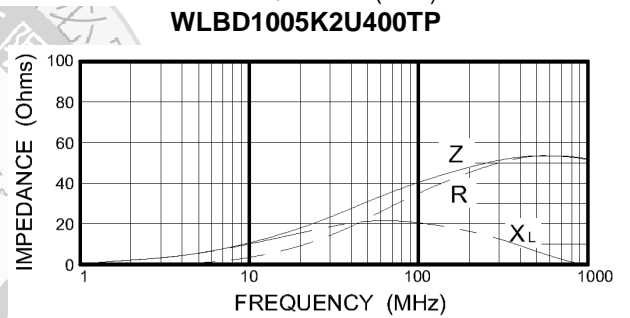
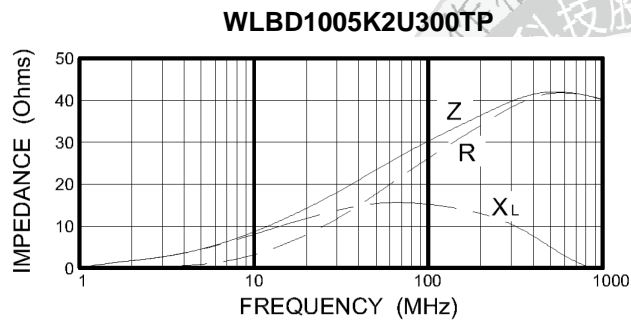
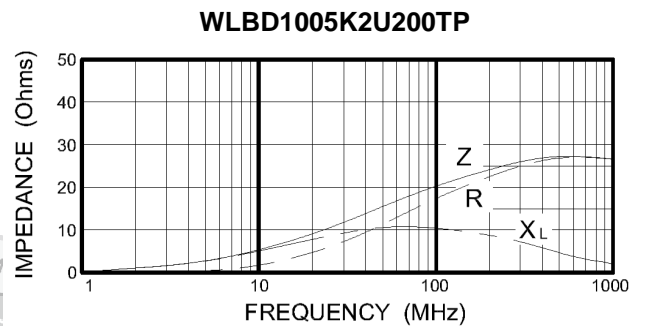
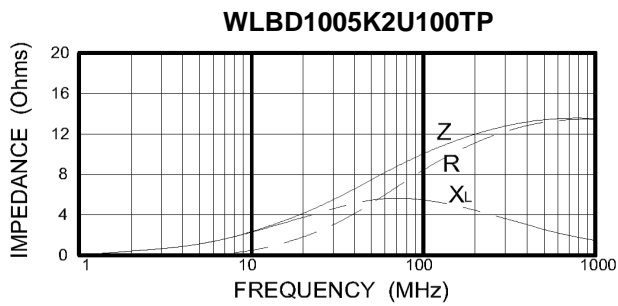

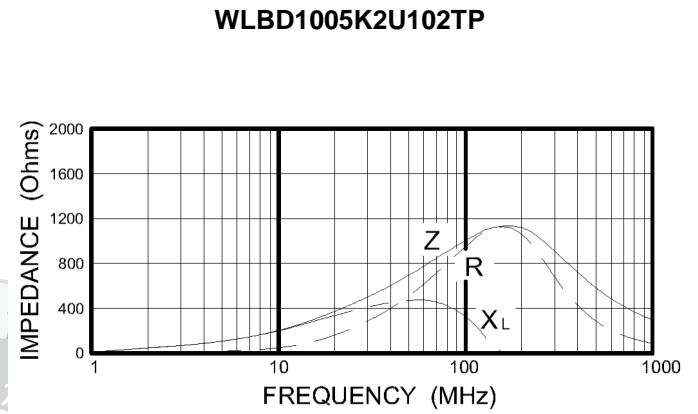
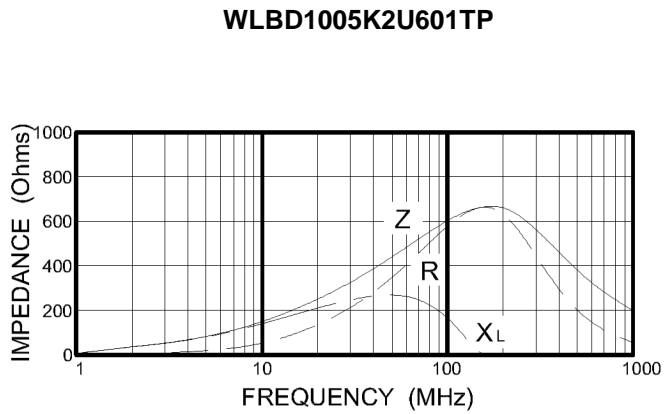
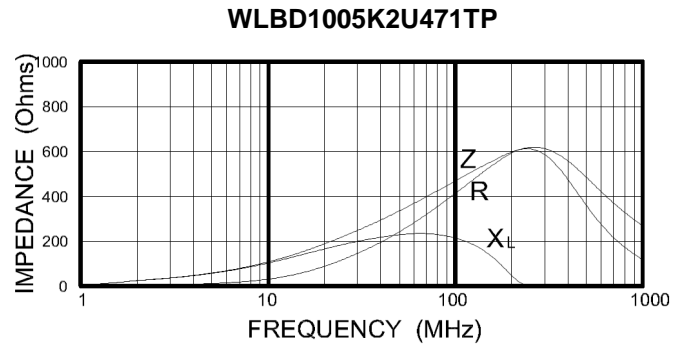
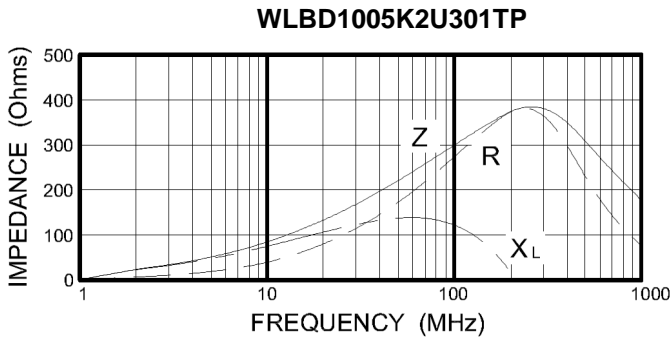

### Impedance Frequency Characteristics(Typical)-1608

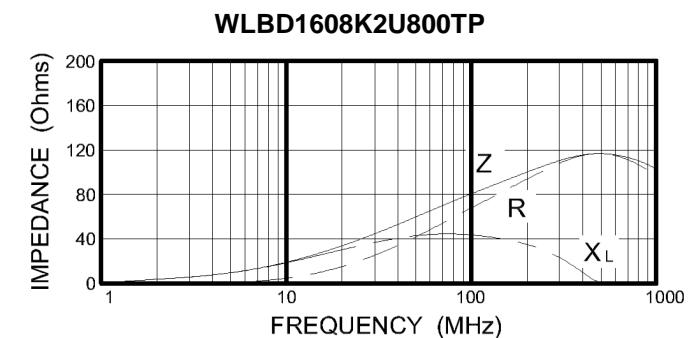
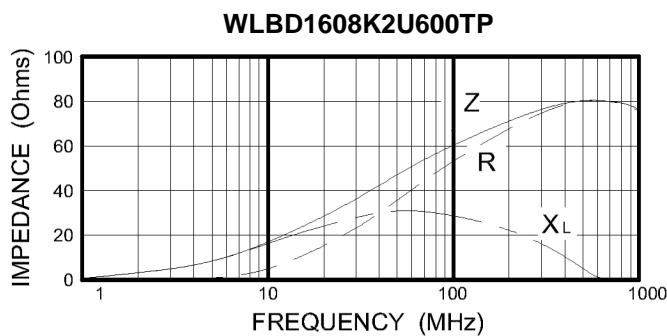
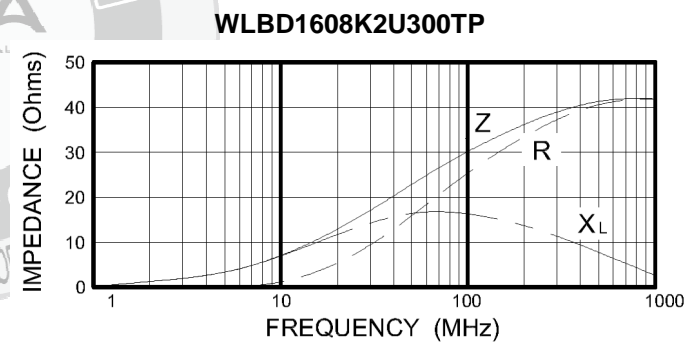
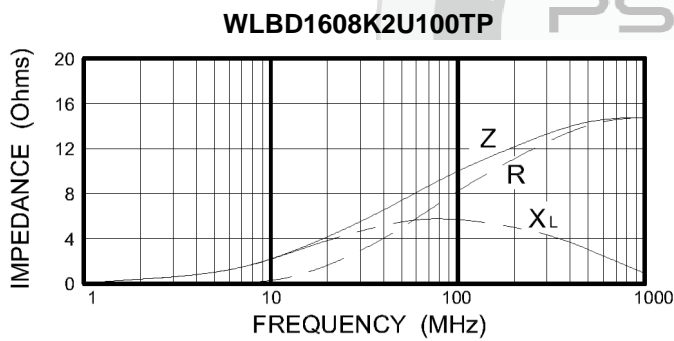

WLBD1608K2U100TP

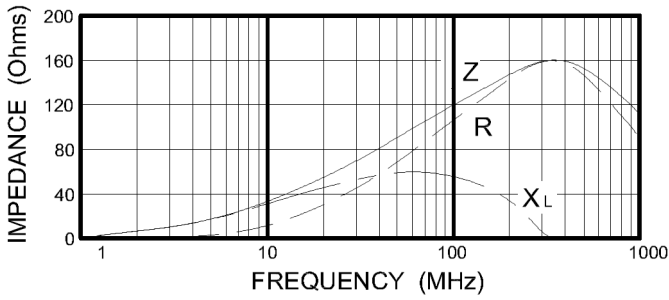

WLBD1608K2U181TP

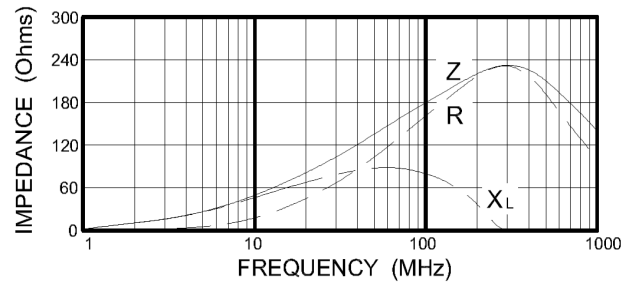

WLBD1608K2U221TP

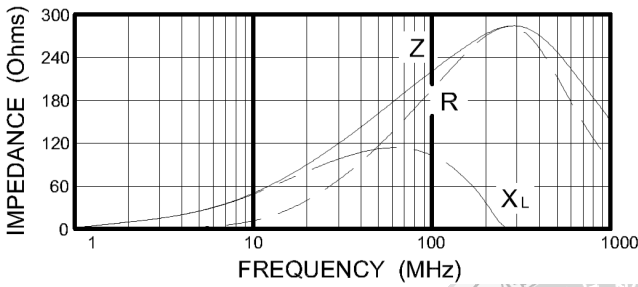

WLBD1608K2U301TP

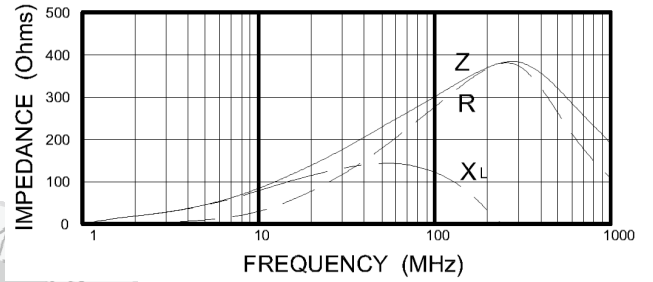

WLBD1608K2U331TP

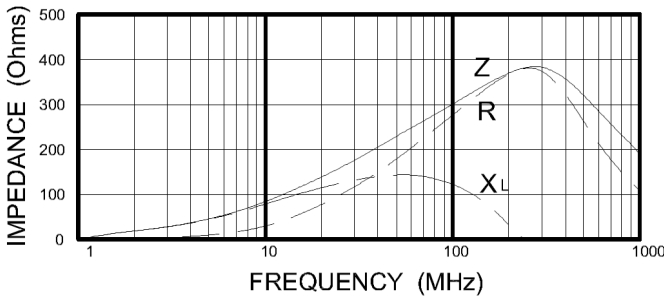

WLBD1608K2U471TP

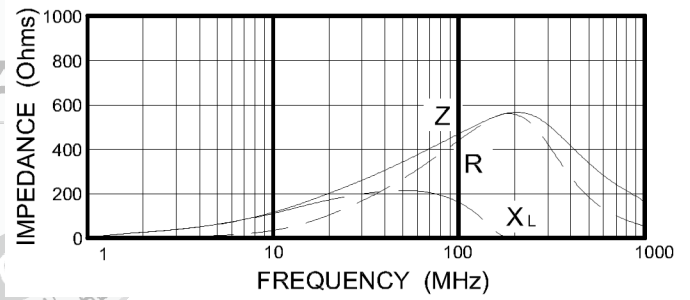

WLBD1608K2U601TP

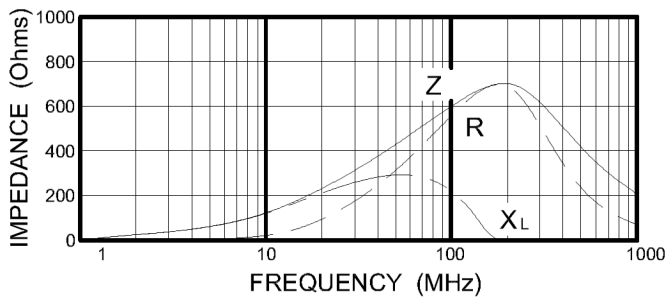

WLBD1608K2U102TP

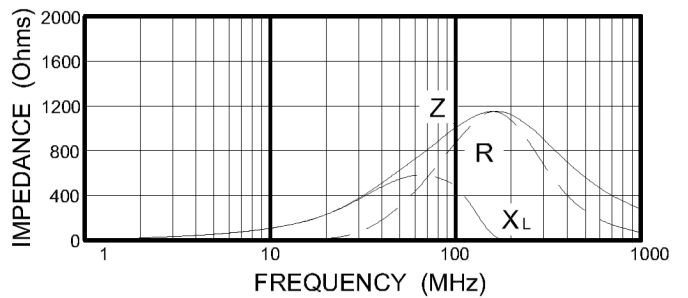

WLBD1608K2U182TP

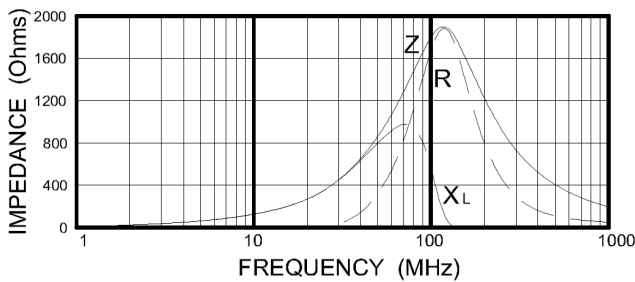

WLBD1608K2U252TP

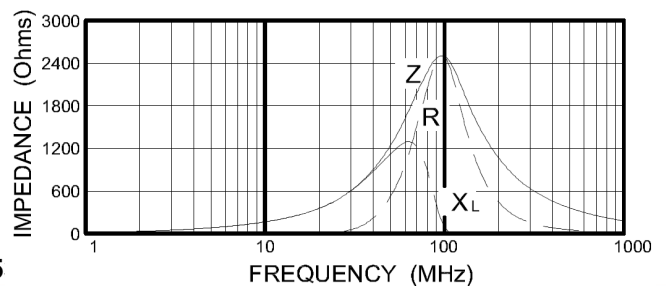

F

WLBD1608K2U252TB

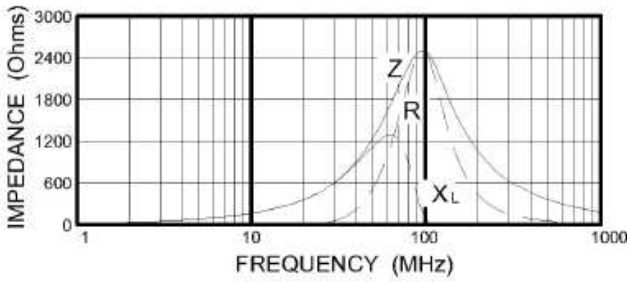

## Impedance Frequency Characteristics(Typical)-2012

WLBD2012K2U300TP

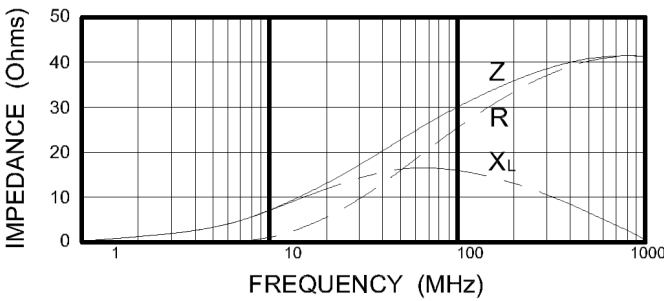

WLBD2012K2U400TP

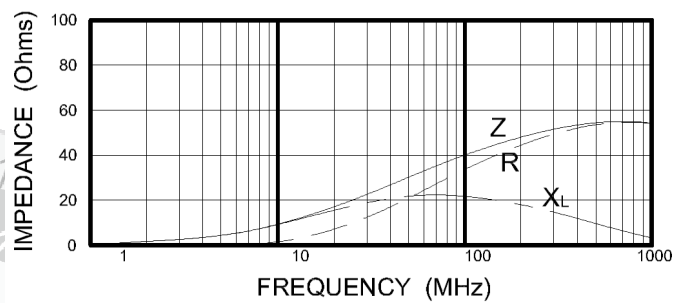

WLBD2012K2U600TP

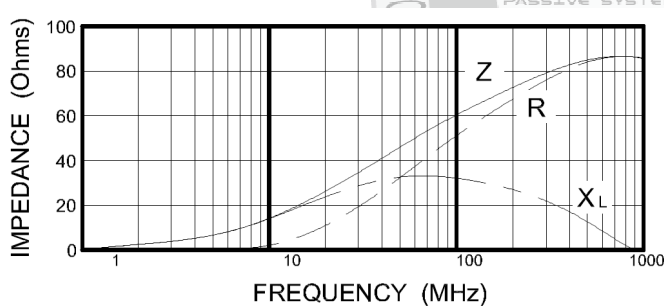

WLBD2012K2U800TP

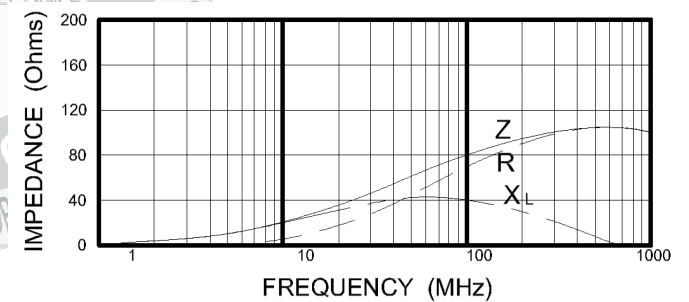

WLBD2012K2U121TP

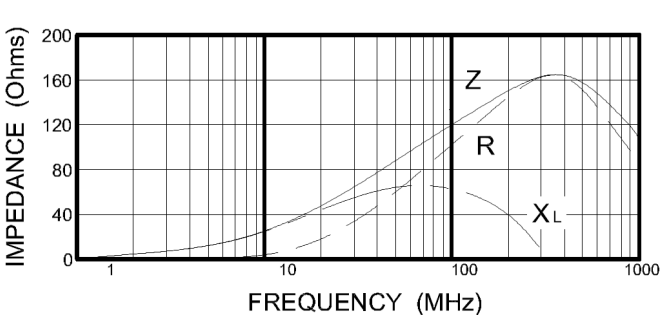

WLBD2012K2U221TP

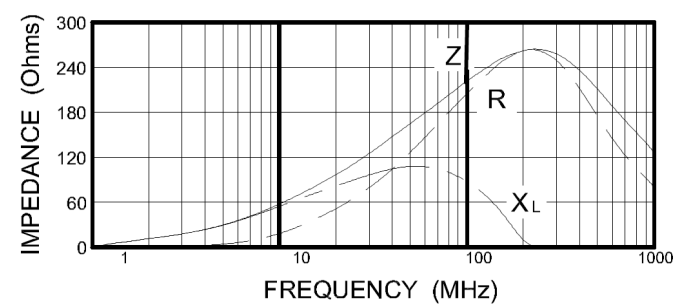

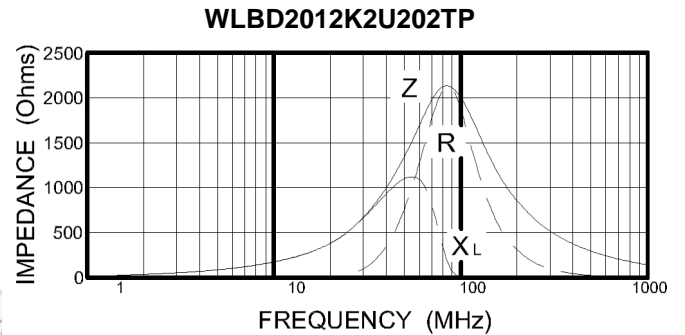
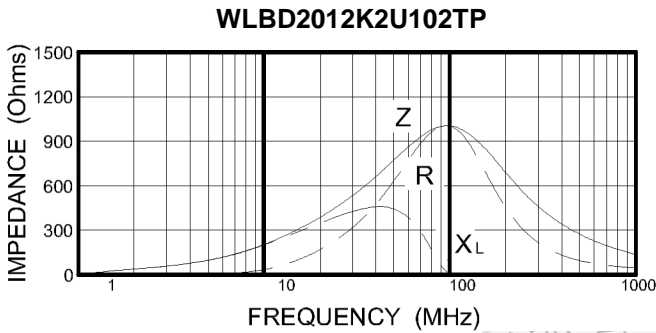
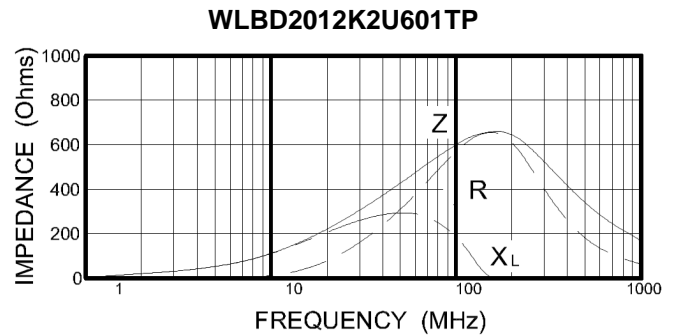
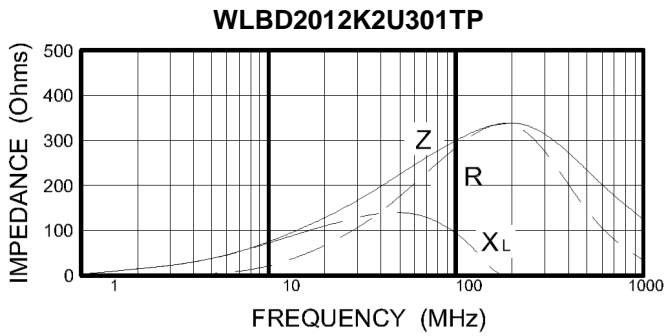

### Impedance Frequency Characteristics(Typical)-3216

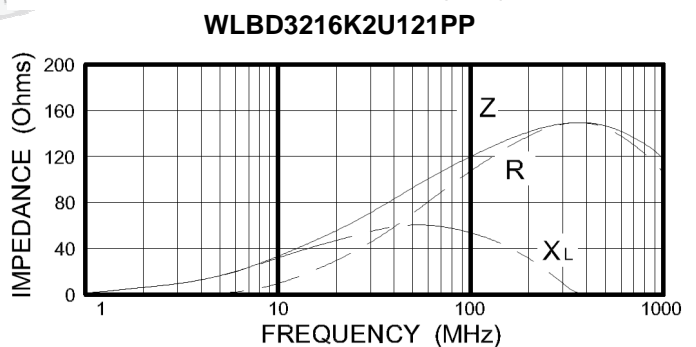
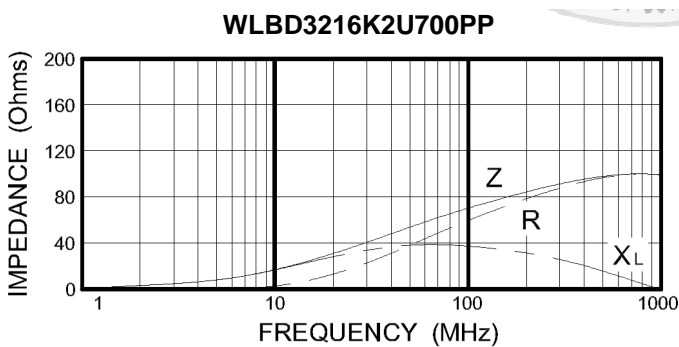
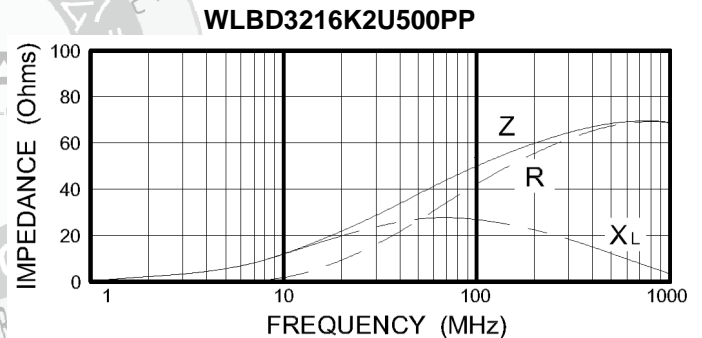
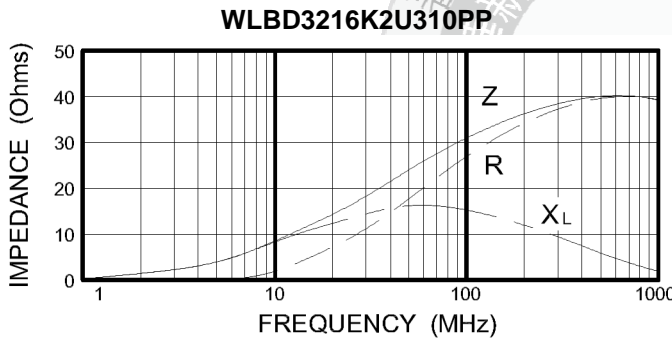

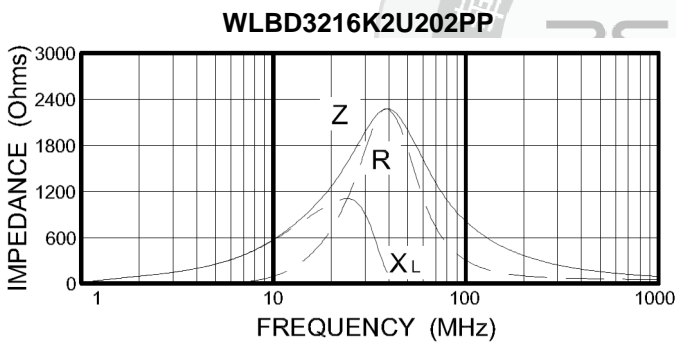
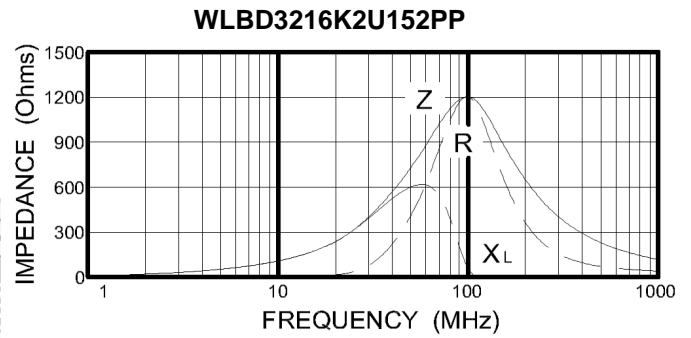
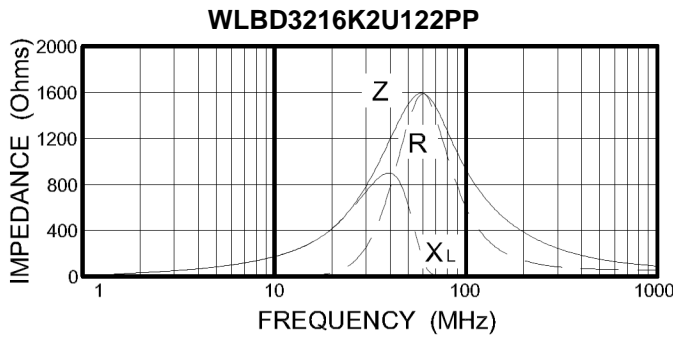
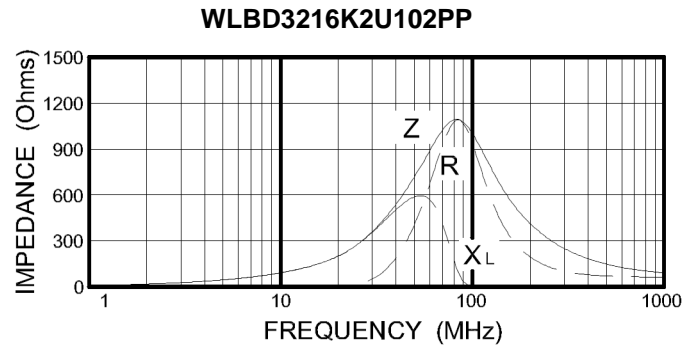
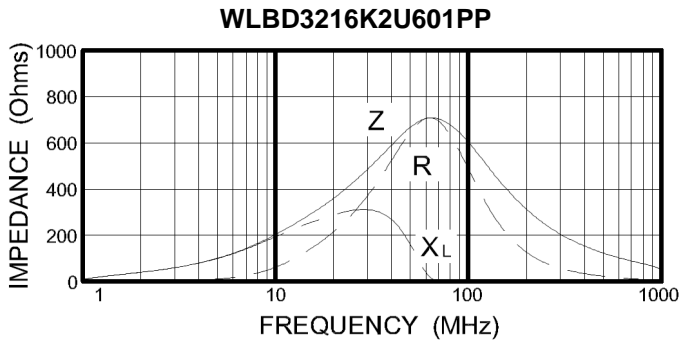

## Impedance Frequency Characteristics(Typical)-3225

