

# APPROVAL SHEET

## WLBD0603 - 4532 HC ( High Current Series ) Chip Bead



\*Contents in this sheet are subject to change without prior notice.

## FEATURES

1. Combination of high frequency noise suppression with capability of handing high current
2. The current rating up to 6 Amps with low DCR

## APPLICATIONS

1. High current DC power lines
2. Circuits where a stable ground is unavailable

## SHAPE and DIMENSION

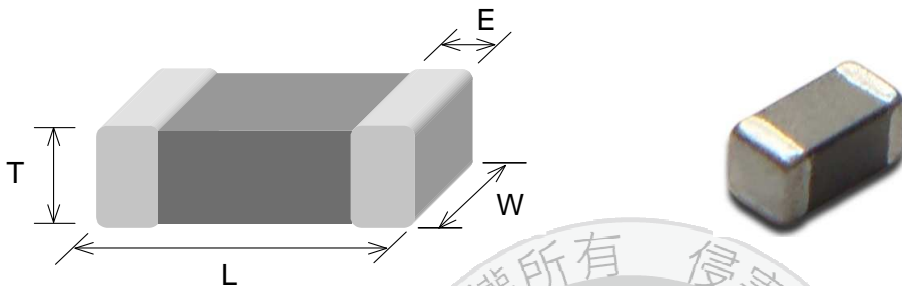

TYPE	0603 (EIA 0201)	1005 (EIA 0402)	*1608 (EIA 0603)	*2012 (EIA 0805)	3216 (EIA 1206)	3225 (EIA 1210)	4516 (EIA 1806)	4532 (EIA 1812)
L	0.60±0.03	1.00±0.10	1.60±0.15	2.00±0.20	3.20±0.20	3.20±0.20	4.50±0.25	4.50±0.25
W	0.30±0.03	0.50±0.10	0.80±0.15	1.25±0.20	1.60±0.20	2.50±0.20	1.60±0.20	3.20±0.25
T	0.30±0.03	0.50±0.10	0.80±0.15 & 0.60±0.15	0.90±0.20 & 1.25±0.2	1.10±0.20	1.30±0.20	1.60±0.20	1.50±0.25
E	0.15±0.05	0.25±0.10	0.30±0.20	0.50±0.30	0.50±0.30	0.50±0.30	0.60±0.40	0.60±0.40
Unit	mm							

## Ordering Information

WL	BD	0603 - 4532	HC	U	300	T / P	H / L
<b>Product Code</b>	<b>Series</b>	<b>Dimensions</b>	<b>Series extension</b>	<b>Tolerance</b>	<b>Value</b>	<b>Packing Code</b>	
WL: Inductor	BD: Chip Bead.	JIS: (EIA) 0603 : (0201) 1005 : (0402) 1608: (0603) 2012: (0805) 3216: (1206) 3225: (1210) 4516: (1806) 4532: (1812)	Refer to characteristic	U: ±25%	300 =30 OHM 601 =600 OHM 102 =1000OHM	T = 7" Paper Tape P = 7" Plastic Tape	H: High current L: Low DCR

## PART NUMBER AND CHARACTERISTICS TABLE

### WLBD0603- 3216 HC\_H series

Walsin Part Number	Impedance ( $\Omega$ ) +/-25%	Test Frequency (MHz)	DC Resistance ( $\Omega$ ) max.	Rated Current (mA) max.
WLBD0603HCU100TH	10	100	0.05	1000
WLBD0603HCU220TH	22	100	0.065	1000
WLBD0603HCU330TH	33	100	0.09	750
WLBD0603HCU470TH	47	100	0.12	500
WLBD0603HCU800TH	80	100	0.18	500
WLBD0603HCU121TH	120	100	0.23	450
WLBD0603HCU241TH	240	100	0.4	350
WLBD0603HCU331TH	330	100	0.5	300
Walsin Part Number	Impedance ( $\Omega$ ) +/-25%	Test Frequency (MHz)	DC Resistance ( $\Omega$ ) max.	Rated Current (mA) max.
WLBD1005HCU100TH	10	100	0.09	2000
WLBD1005HCU300TH	30	100	0.04	3000
WLBD1005HCU330TH	33	100	0.04	3000
WLBD1005HCU600TH	60	100	0.07	2500
WLBD1005HCU121TH	120	100	0.15	1500
Walsin Part Number	Impedance ( $\Omega$ ) +/-25%	Test Frequency (MHz)	DC Resistance ( $\Omega$ ) max.	Rated Current (mA) max.
WLBD1608HCU300TH	30	100	0.04	3000
WLBD1608HCU600TH	60	100	0.04	3000
WLBD1608HCU800TH	80	100	0.04	3000
WLBD1608HCU121TH	120	100	0.07	2500
WLBD1608HCU221TH	220	100	0.09	2000
WLBD1608HCU301TH	300	100	0.09	2000
WLBD1608HCU471TH	470	100	0.20	1000
WLBD1608HCU601TH	600	100	0.20	1000
WLBD1608HCU102TH	1000	100	0.25	800
Walsin Part Number	Impedance ( $\Omega$ ) +/-25%	Test Frequency (MHz)	DC Resistance ( $\Omega$ ) max.	Rated Current (mA) max.
WLBD2012HCU310TH	31	100	0.015	6000
WLBD2012HCU400TH	40	100	0.03	4000
WLBD2012HCU600TH	60	100	0.04	3000
WLBD2012HCU800TH	80	100	0.02	5000
WLBD2012HCU121TH	120	100	0.02	5000
WLBD2012HCU181TH	180	100	0.03	4000
WLBD2012HCU221TH	220	100	0.04	3000
WLBD2012HCU301TH	300	100	0.09	2000
WLBD2012HCU331TH	330	100	0.09	2000
WLBD2012HCU601TH	600	100	0.09	2000
**WLBD2012HCU102TH	1000	100	0.09	2000
WLBD2012HCU152TH	1500	100	0.3	1500

## PART NUMBER AND CHARACTERISTICS TABLE

### WLBD3225- 4532 HC\_H series

Walsin Part Number	Impedance ( $\Omega$ ) +/-25%	Test Frequency (MHz)	DC Resistance ( $\Omega$ ) max.	Rated Current (mA) max.
WLBD3216HCU300PH	30	100	0.015	6000
WLBD3216HCU500PH	50	100	0.015	6000
WLBD3216HCU800PH	80	100	0.03	4000
WLBD3216HCU121PH	120	100	0.015	6000
WLBD3216HCU601PH	600	100	0.07	2500
WLBD3216HCU122PH	1200	100	0.2	1000
Walsin Part Number	Impedance ( $\Omega$ ) +/-25%	Test Frequency (MHz)	DC Resistance ( $\Omega$ ) max.	Rated Current (mA) max.
WLBD3225HCU600PH	60	100	0.15	1500
WLBD3225HCU102PH	1000	50	0.09	2000
Walsin Part Number	Impedance ( $\Omega$ ) +/-25%	Test Frequency (MHz)	DC Resistance ( $\Omega$ ) max.	Rated Current (mA) max.
WLBD4516HCU600PH	60	100	0.015	6000
WLBD4516HCU720PH	72	100	0.015	6000
WLBD4516HCU181PH	180	100	0.02	3500
WLBD4516HCU851PH	850	100	0.15	1500
Walsin Part Number	Impedance ( $\Omega$ ) +/-25%	Test Frequency (MHz)	DC Resistance ( $\Omega$ ) max.	Rated Current (mA) max.
WLBD4532HCU800PH	80	100	0.01	9000
WLBD4532HCU121PH	120	100	0.015	6000
WLBD4532HCU601PH	600	50	0.04	3000
WLBD4532HCU132PH	1300	60	0.04	3000
Test Level	250 mV			
Test Instruments	<ul style="list-style-type: none"> <li>• HP4291B RF IMPEDANCE / MATERIAL ANALYZER</li> <li>• HP4338A/B MILLIOHMMETER</li> <li>• Agilent 8720ES S-PARAMETER NETWORK ANALYZER</li> <li>• HP6632B SYSTEM DC POWER SUPPLY</li> </ul>			

### GENERAL TECHNICAL DATA

1. Operating temperature range : - 55°C ~ +125°C
2. Storage Condition : Less than 40°C and 70% RH
3. Storage Time: 12 months(Size:1005 above)
4. Soldering method: Reflow or Wave Soldering
5. \*\* The thickness  $1.25 \pm 0.2\text{mm}$  / MOQ= 3K reel

## PART NUMBER AND CHARACTERISTICS TABLE

WLBD0603- 1608 HC\_L series ( Low DCR Type)

Walsin Part Number	Impedance (Ω) +/-25%	Test Frequency (MHz)	DC Resistance (Ω) Max.	Rated Current (mA) Max.	
				85°C	125°C
WLBD0603HCU220TL	22	100	0.04	1800	1450
WLBD0603HCU330TL	33	100	0.055	1500	1200
WLBD0603HCU800TL	80	100	0.13	1000	800
WLBD0603HCU121TL	120	100	0.16	900	700
Walsin Part Number	Impedance (Ω) +/-25%	Test Frequency (MHz)	DC Resistance (Ω) Max.	Rated Current (mA) Max.	
				85°C	125°C
WLBD1005HCU330TL	33	100	0.022	3000	1700
WLBD1005HCU600TL	60	100	0.032	2500	1400
WLBD1005HCU800TL	80	100	0.038	2300	1300
WLBD1005HCU121TL	120	100	0.055	2000	1100
WLBD1005HCU181TL	180	100	0.090	1500	800
WLBD1005HCU221TL	220	100	0.100	1400	800
WLBD1005HCU331TL	330	100	0.150	1200	700
WLBD1005HCU471TL	470	100	0.200	1000	600
WLBD1005HCU601TL	600	100	0.230	900	500
Walsin Part Number	Impedance (Ω) +/-25%	Test Frequency (MHz)	DC Resistance (Ω) Max.	Rated Current (mA) Max.	
				85°C	125°C
**WLBD1608HCU260TL	26	100	0.007	6000	4000
**WLBD1608HCU300TL	30	100	0.010	5000	3000
**WLBD1608HCU700TL	70	100	0.022	3500	2000
**WLBD1608HCU101TL	100	100	0.030	3000	1900
**WLBD1608HCU121TL	120	100	0.030	3000	1900
WLBD1608HCU221TL	220	100	0.050	2200	1500
WLBD1608HCU331TL	330	100	0.080	1700	1200
WLBD1608HCU471TL	470	100	0.130	1500	1000
WLBD1608HCU601TL	600	100	0.150	1300	1000
Test Level	250 mV				
Test Instruments	<ul style="list-style-type: none"> <li>•HP4991A RF Impedance / Material Analyzer</li> <li>•HP4338A/B Milliohm meter</li> <li>•Agilent 5071C S-Parameter Network Analyzer</li> <li>•HP6632B System DC Power Supply</li> </ul>				

### GENERAL TECHNICAL DATA

1. Operating temperature range : - 55°C ~ +125°C
2. Storage Condition : Less than 40°C and 70% RH
3. Storage Time : 6 months(Size:0603&1005)  
12 months(Size:1608 above)
4. Soldering method : Reflow
5. \*\* The thickness 0.6mm

6. In operating temperature exceeding +85°C, derating of current is set according to the operating temperature graph as follows

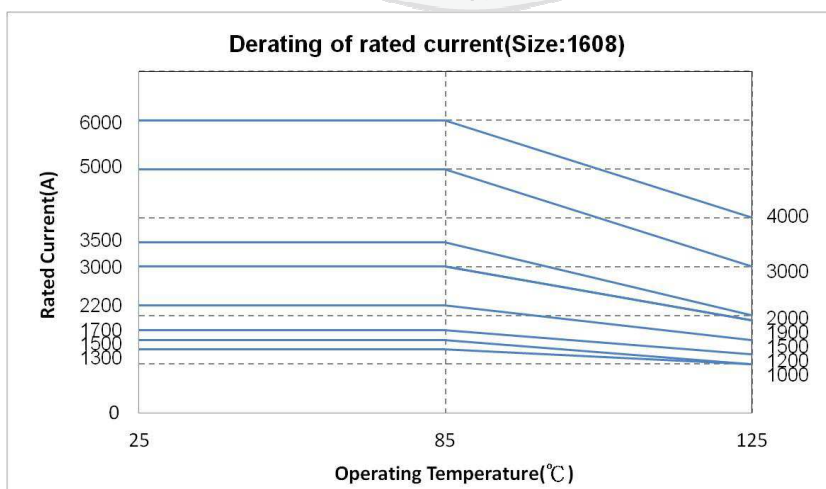
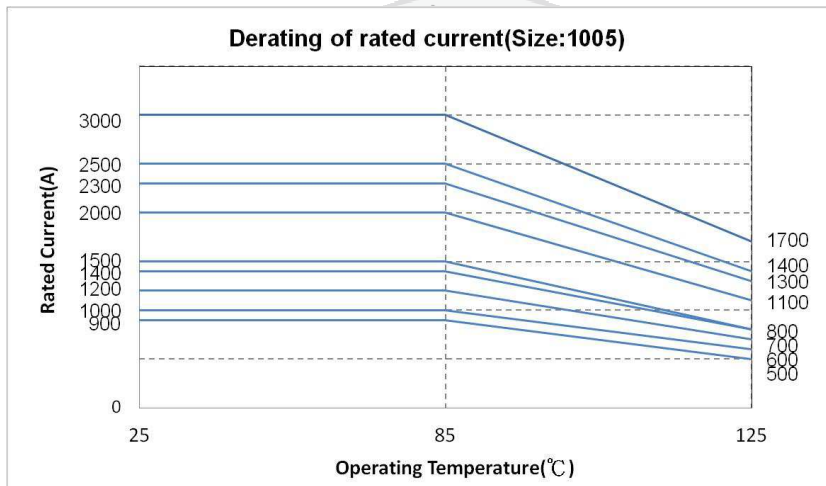
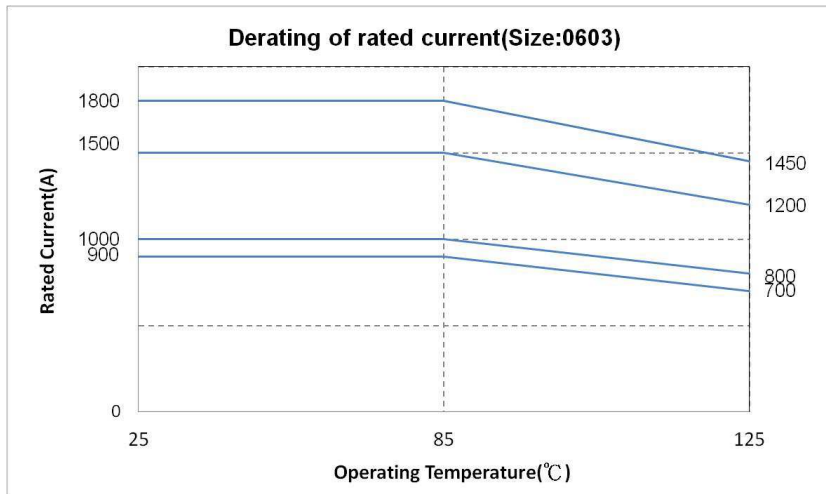

### Land Patterns for Reflow Soldering

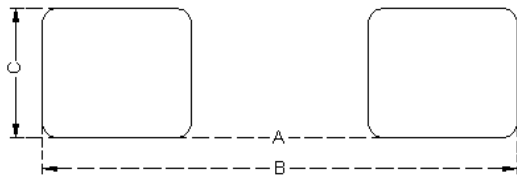

### Solder Land Information

Unit: mm (inches)

Size	A	B	C
0603	0.2~0.3	0.75~1.05	0.3
1005	0.4 (0.016)	1.2 ~1.4 (0.047 ~0.055)	0.5 (0.020)
1608	0.7 (0.028)	1.8~ 2.0 (0.071~ 0.079)	0.7 (0.028)
2012	1.2 (0.047)	3.0 ~4.0 (0.118 ~0.157)	1.0 (0.039)
3216	2.0 (0.079)	4.2 ~5.2 (0.165 ~0.205)	1.2 (0.047)
3225	2.0 (0.079)	4.2 ~5.2 (0.165 ~0.205)	3.4 (0.134)
4516	3.0 (0.118)	5.5~6.5 (0.217 ~0.256)	1.2 (0.047)
4532	3.0 (0.118)	5.5 ~6.5 (0.217 ~0.256)	4.22 (0.166)

### RECOMMENDED SOLDERING CONDITIONS

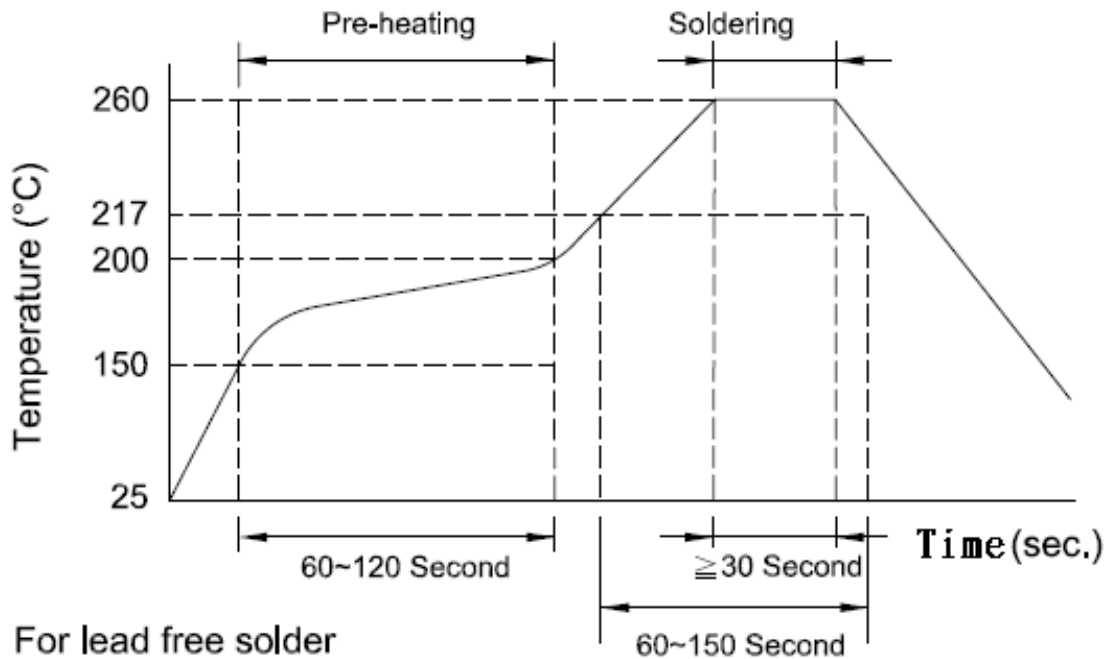



## RELIABILITY AND TEST CONDITION

Test item	Test Condition	Criteria
Temperature Cycle	Temperature : -55 ~ +125°C Cycle : 100 cycles Dwell time : 30minutes Measurement : at ambient temperature 24 hours after test completion	No mechanical damage Impedance value should be within $\pm 20\%$ of the initial value
Operational Life	Temperature : 125°C $\pm 5^\circ\text{C}$ Test time : 1000 hours Apply current : full rated current Measurement : at ambient temperature 24 hours after test completion	No mechanical damage Impedance value should be within $\pm 20\%$ of the initial value
Rated Current Test	Apply current : full rated current / 5min	Temperature rise should be less than 40°C
Biased Humidity	Temperature : 40°C $\pm 2^\circ\text{C}$ Humidity : 90 ~ 95 % RH Test time : 1000 hours Apply current : full rated current Measurement : at ambient temperature 24 hours after test completion	No mechanical damage Impedance value should be within $\pm 20\%$ of the initial value
Resistance to Solder Heat	Solder temperature : 260 $\pm 5^\circ\text{C}$ Flux : Rosin DIP time : 10 $\pm 1$ sec	More than 95 % of terminal electrode should be covered with new solder No mechanical damage Impedance value should be within $\pm 20\%$ of the initial value
Adhesive Test	Reflow temperature : 245°C It shall be Soldered on the substrate applying direction parallel to the substrate Apply force(F) : 5 N Test time : 10 sec	No mechanical damage Soldering the products on PCB after the pulling test force > 5 N
Steam Aging Test	Temperature : 93°C Test time : 4 hours(WLCM1005) Others : 8 hours Solder temperature : 235 $\pm 5^\circ\text{C}$ Flux : Rosin DIP time : 5 $\pm 1$ sec	More than 95 % of terminal electrode should be covered with new solder



## Bead 0603- Impedance Frequency Characteristics (Typical)

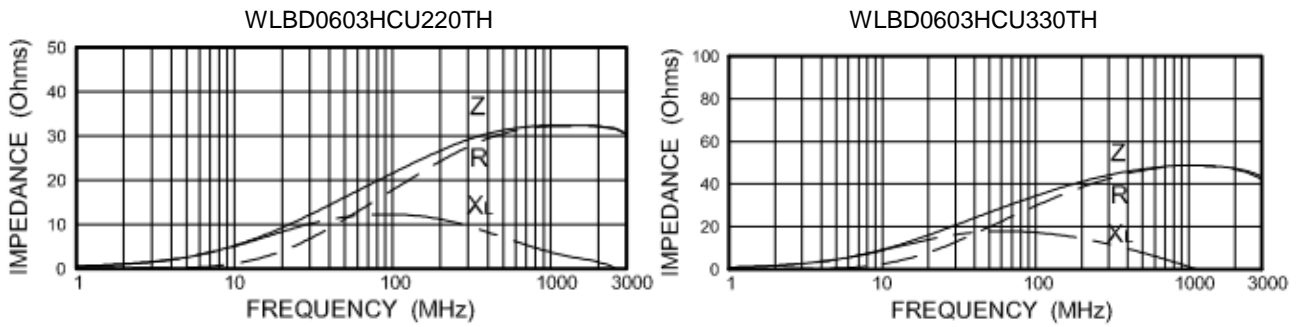

## Bead 1005- Impedance Frequency Characteristics (Typical)

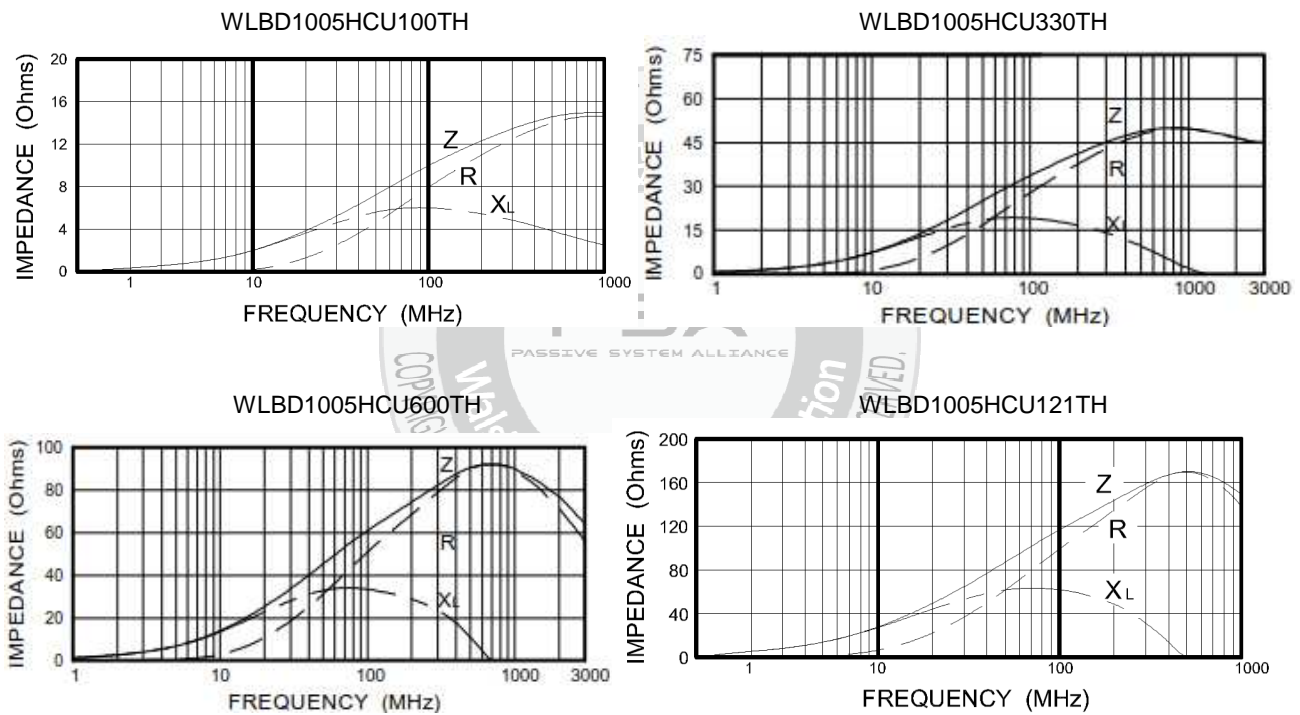

## Bead 1608- Impedance Frequency Characteristics (Typical)

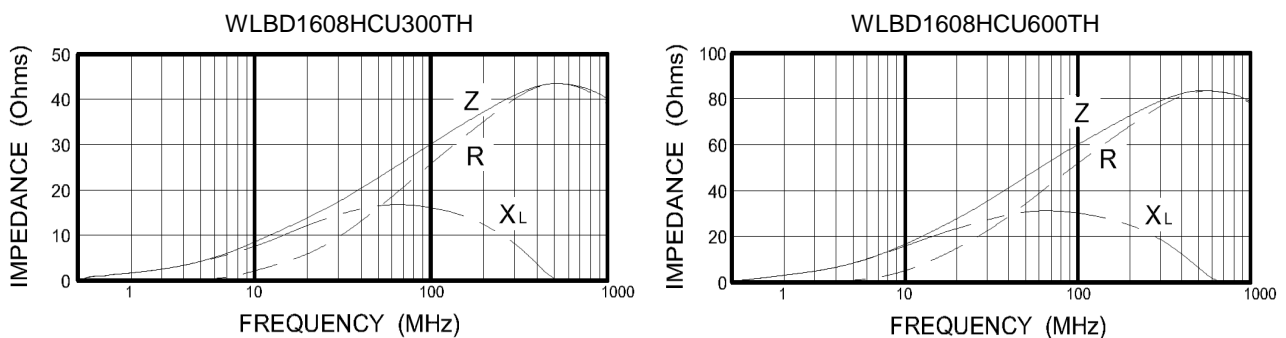

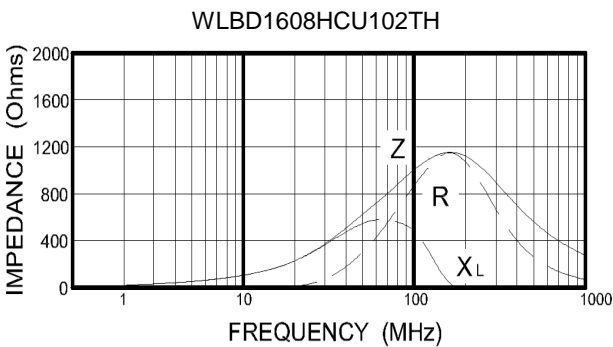
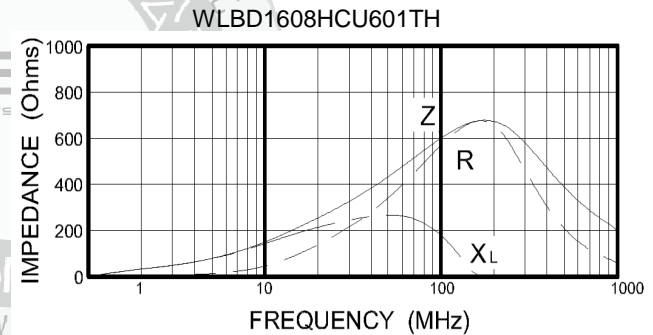
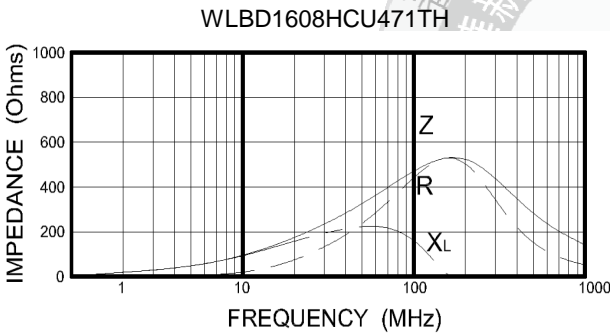
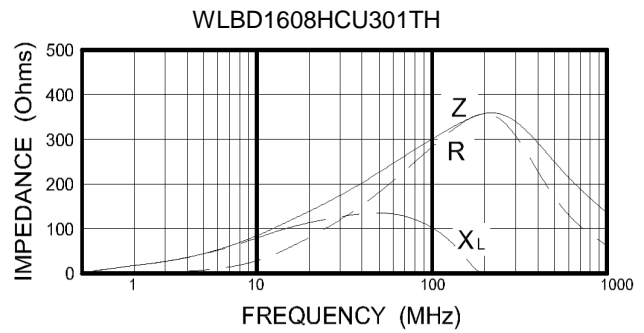
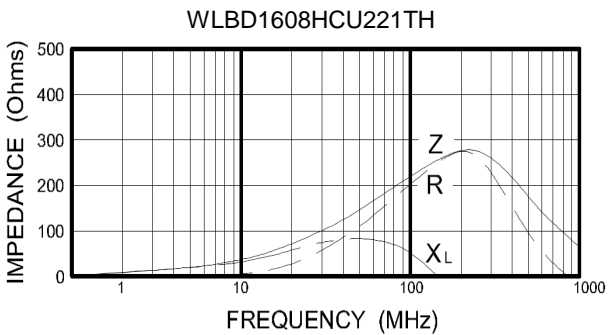
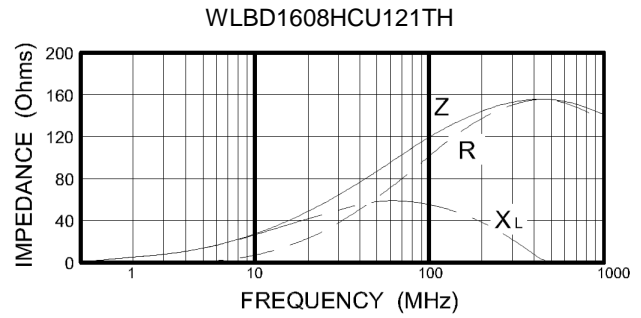
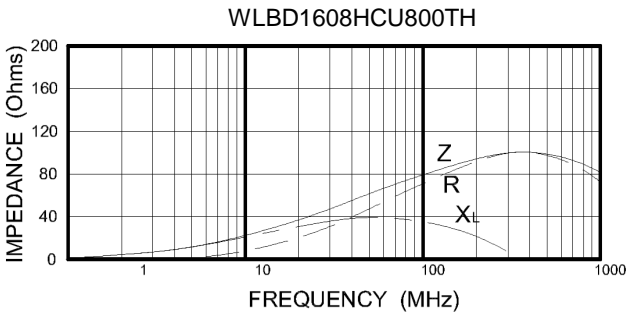

## Bead 2012- Impedance Frequency Characteristics(Typical)

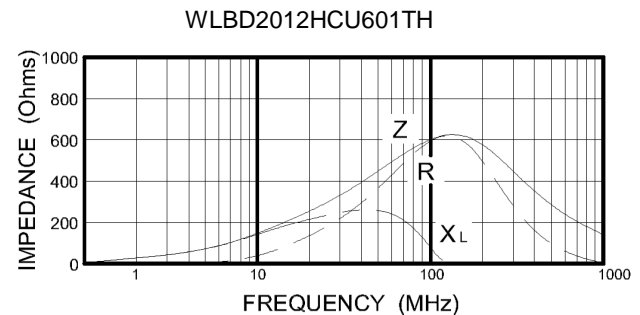
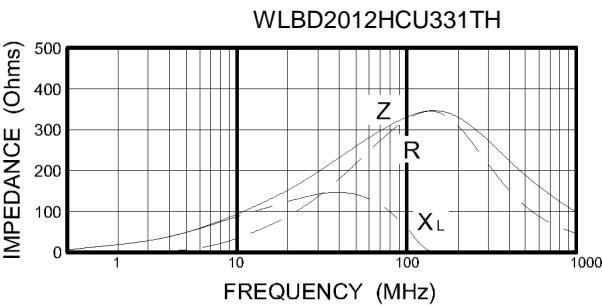
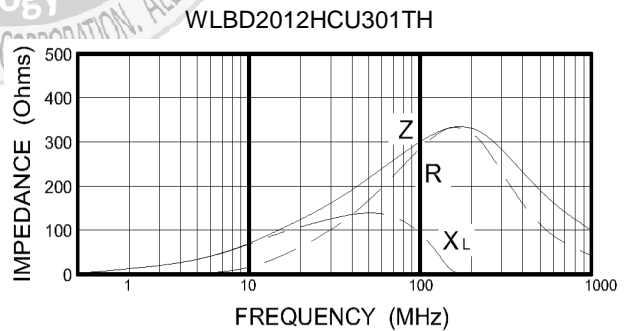
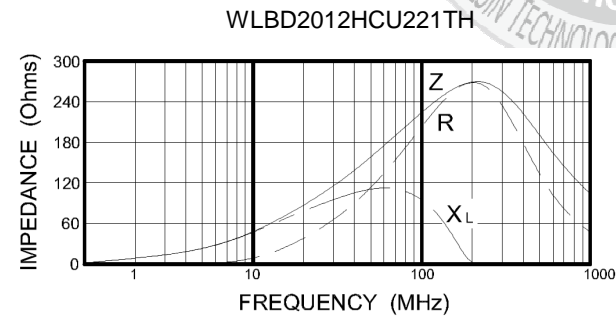
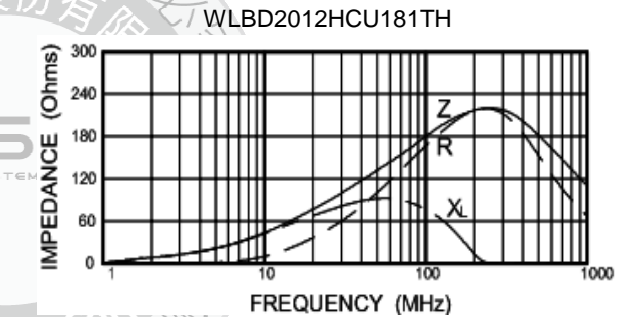
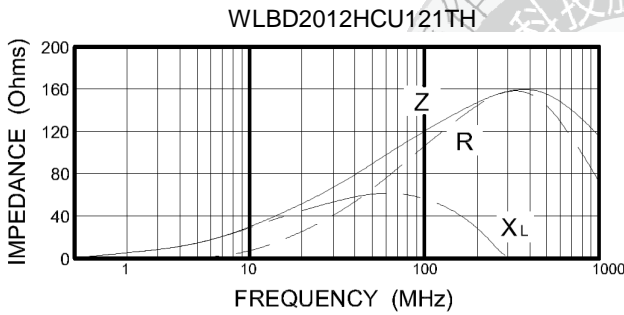
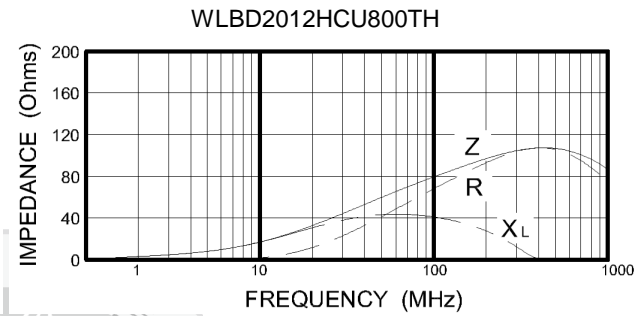
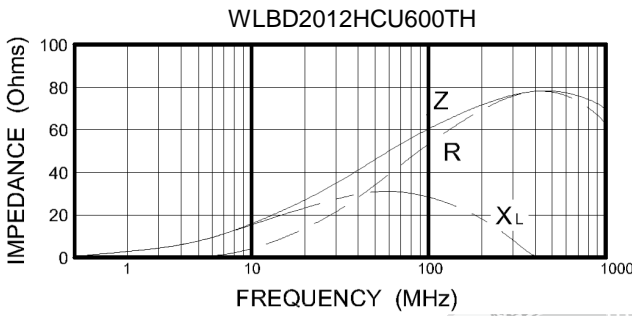
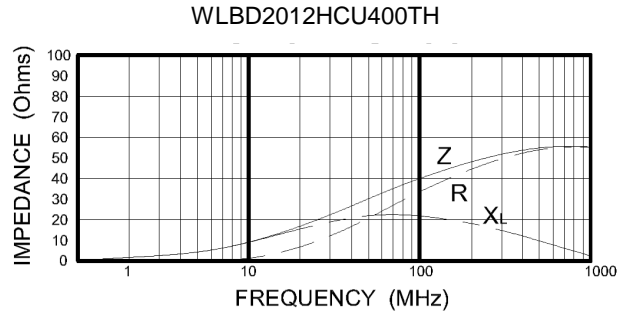
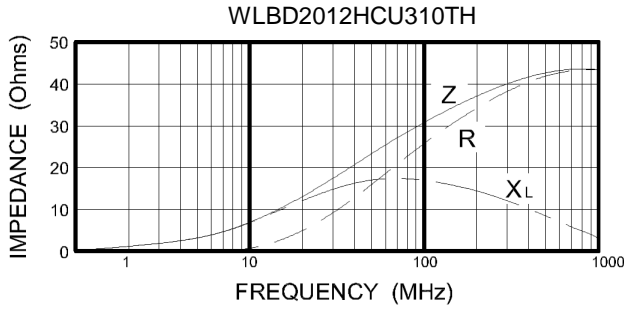

\*\*WLBD2012HCU102TH

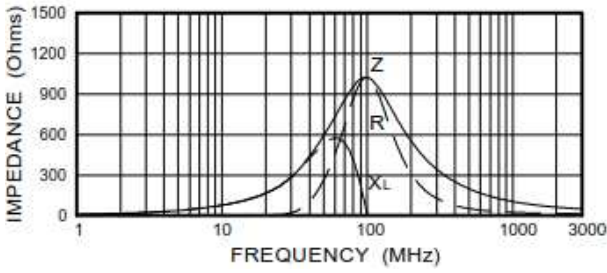

WLBD2012HCU152TH

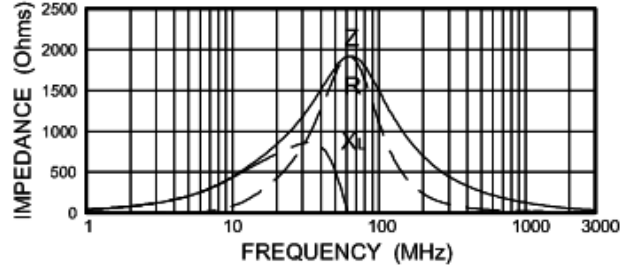

### Bead 3216- Impedance Frequency Characteristics(Typical)

WLBD3216HCU300PH

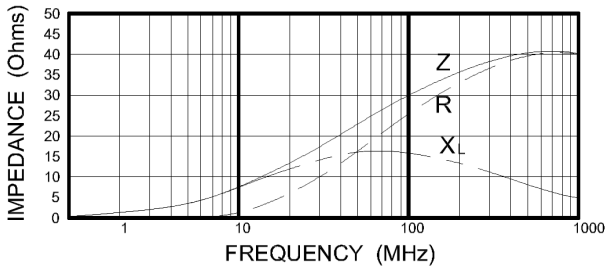

WLBD3216HCU500PH

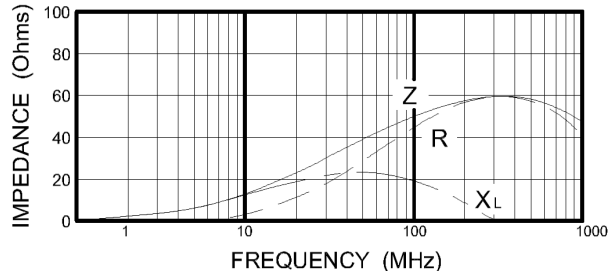

WLBD3216HCU800PH

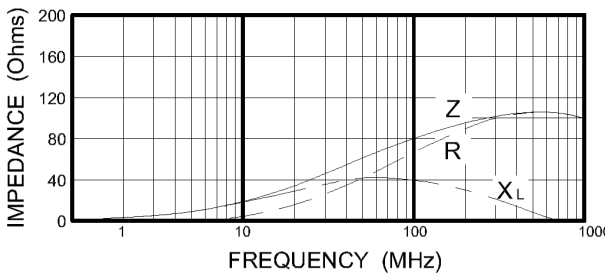

WLBD3216HCU121PH

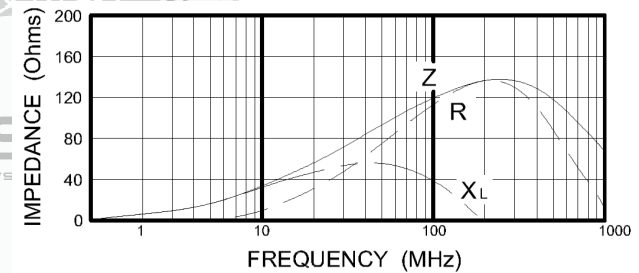

WLBD3216HCU601PH

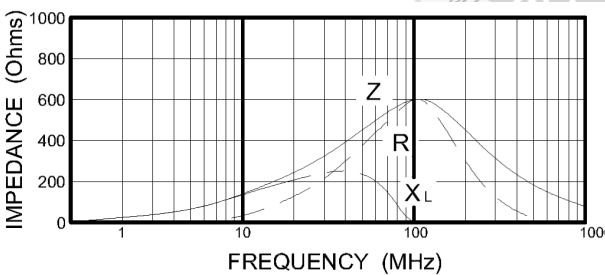

WLBD3216HCU122PH

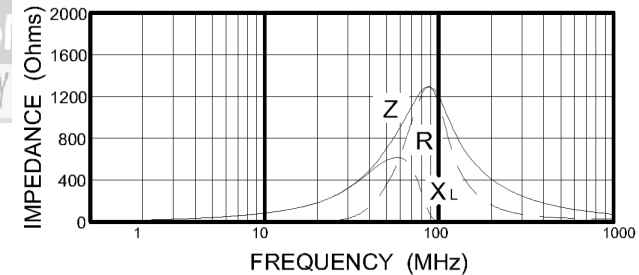

### Bead 3225- Impedance Frequency Characteristics(Typical)

WLBD3225HCU600PH

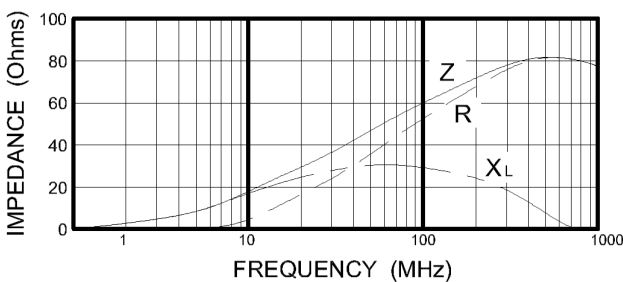

WLBD3225HCU102PH

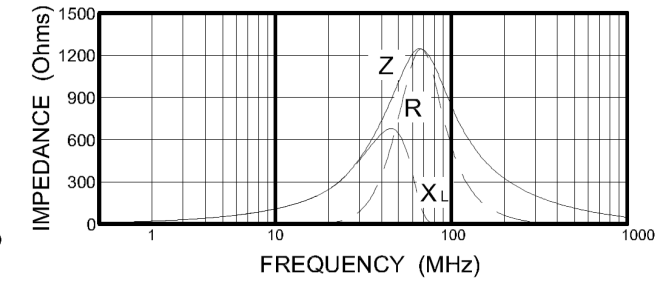

## Bead 4516- Impedance Frequency Characteristics (Typical)

WLBD4516HCU600PH

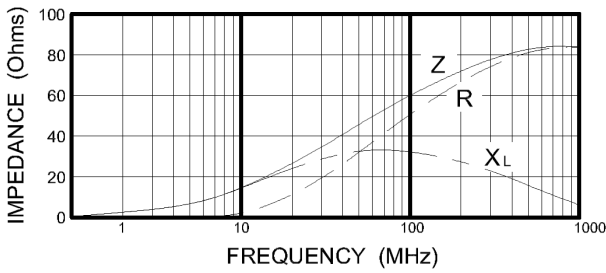

WLBD4516HCU181PH

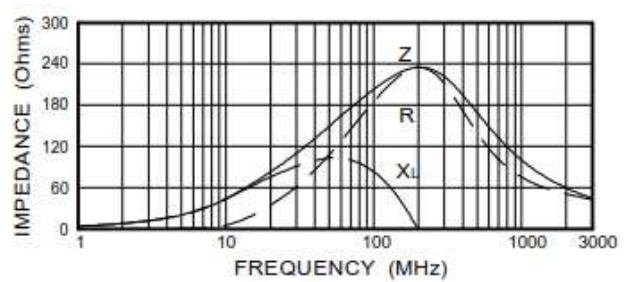

WLBD4516HCU720PH

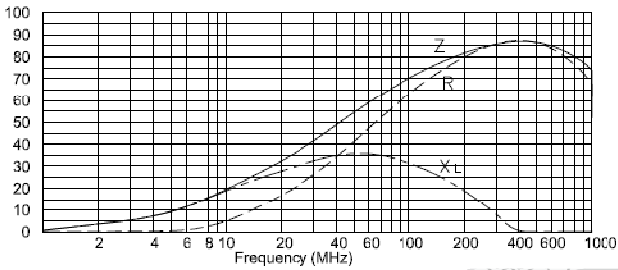

WLBD4516HCU851PH

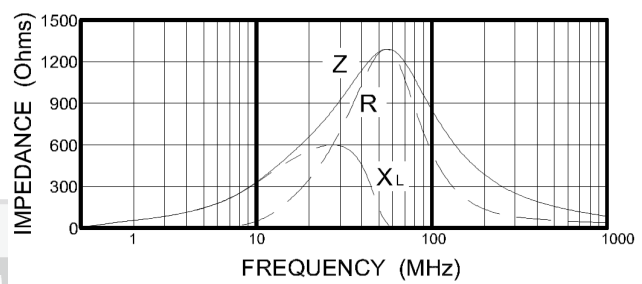

## Bead 4532- Impedance Frequency Characteristics (Typical)

WLBD4532HCU800PH

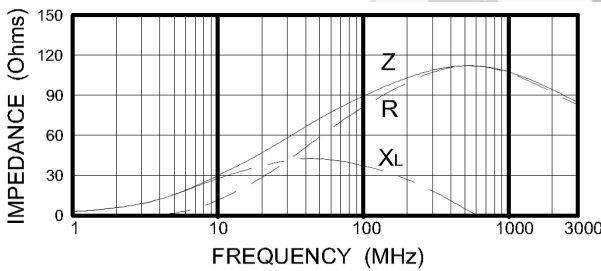

WLBD4532HCU12PH

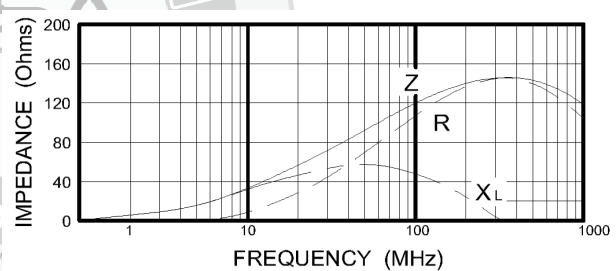

WLBD4532HCU601PH

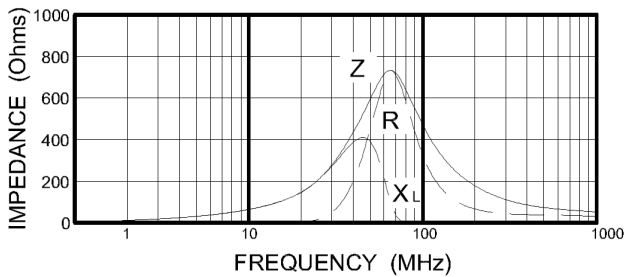

WLBD4532HCU132PH

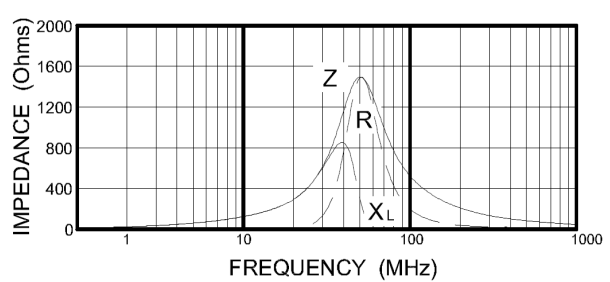

## Bead 0603L- Impedance Frequency Characteristics (Typical)

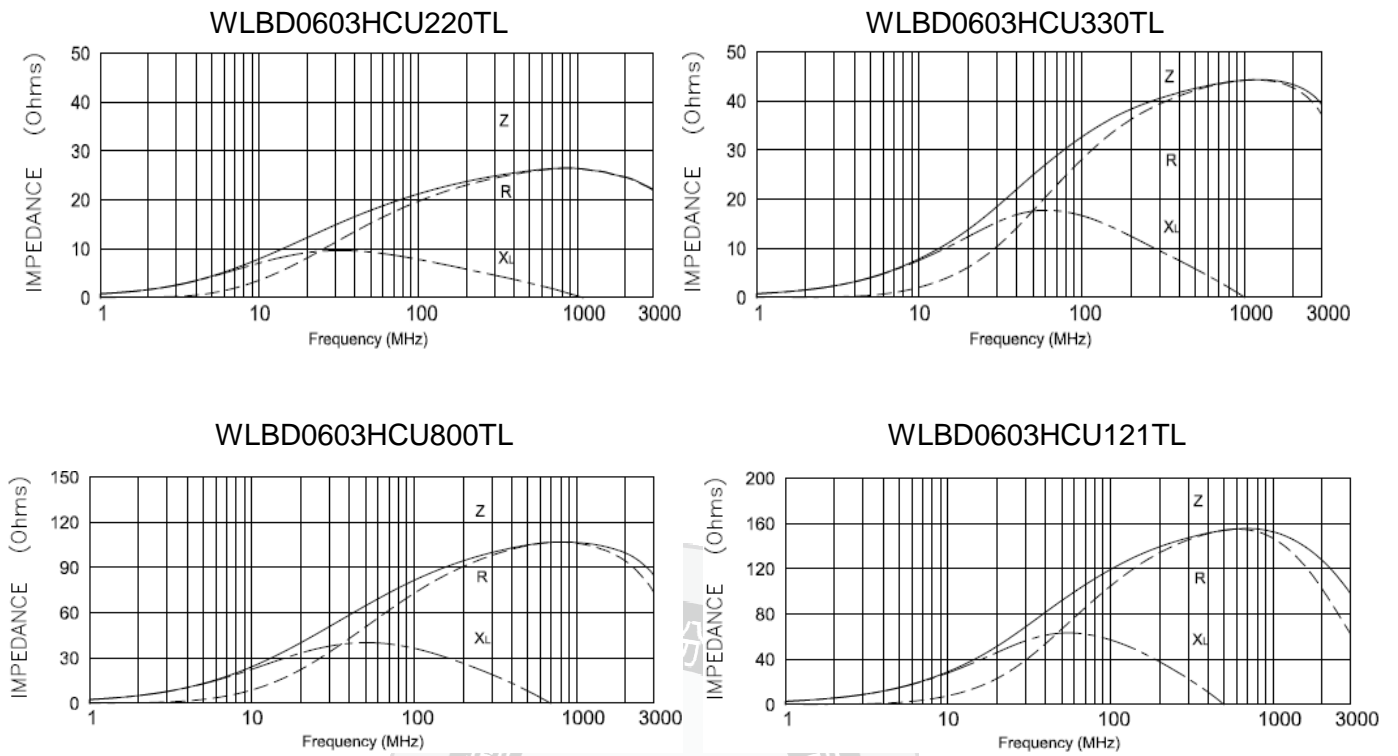

## Bead 1005L- Impedance Frequency Characteristics (Typical)

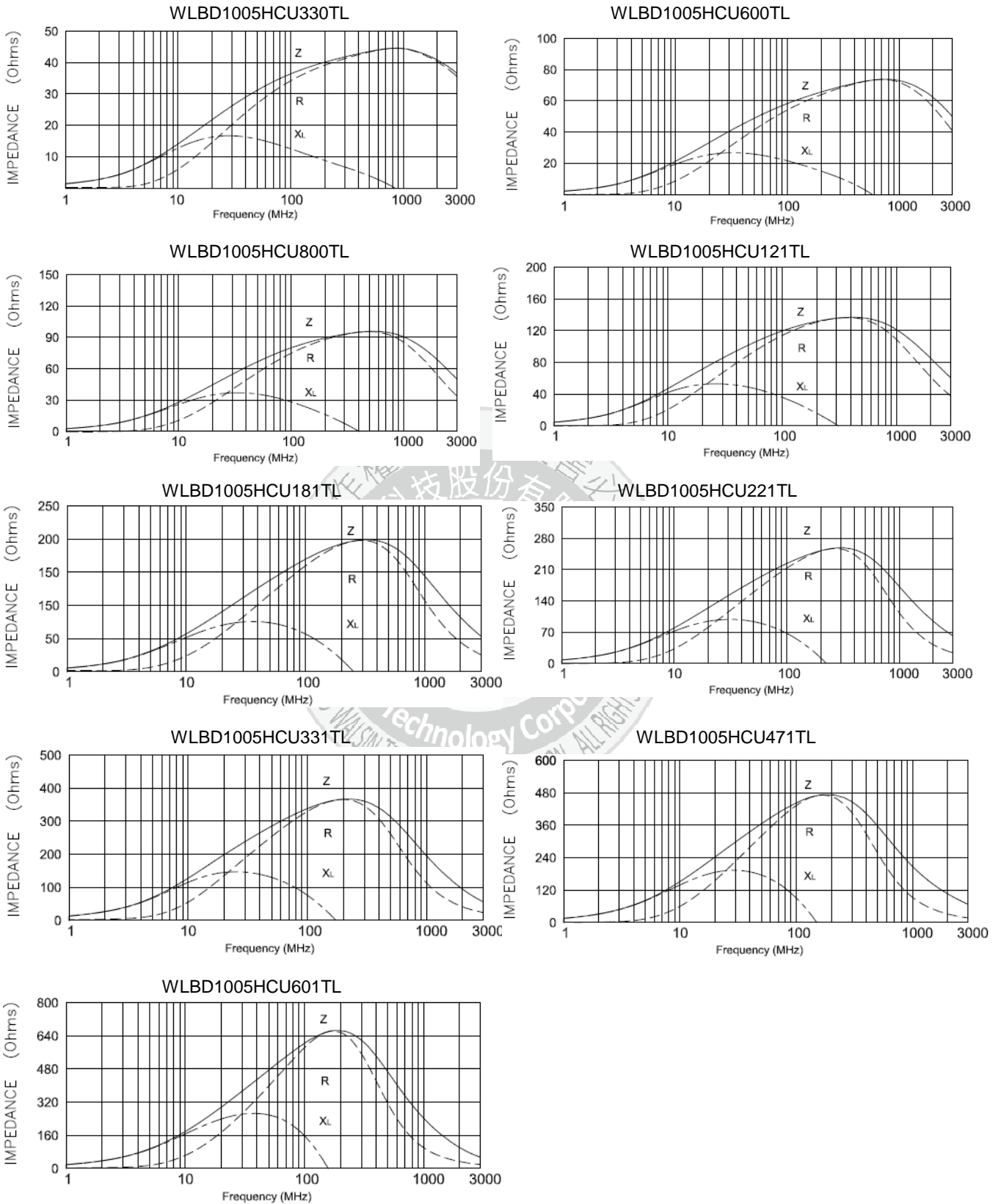



## Bead 1608L- Impedance Frequency Characteristics (Typical)

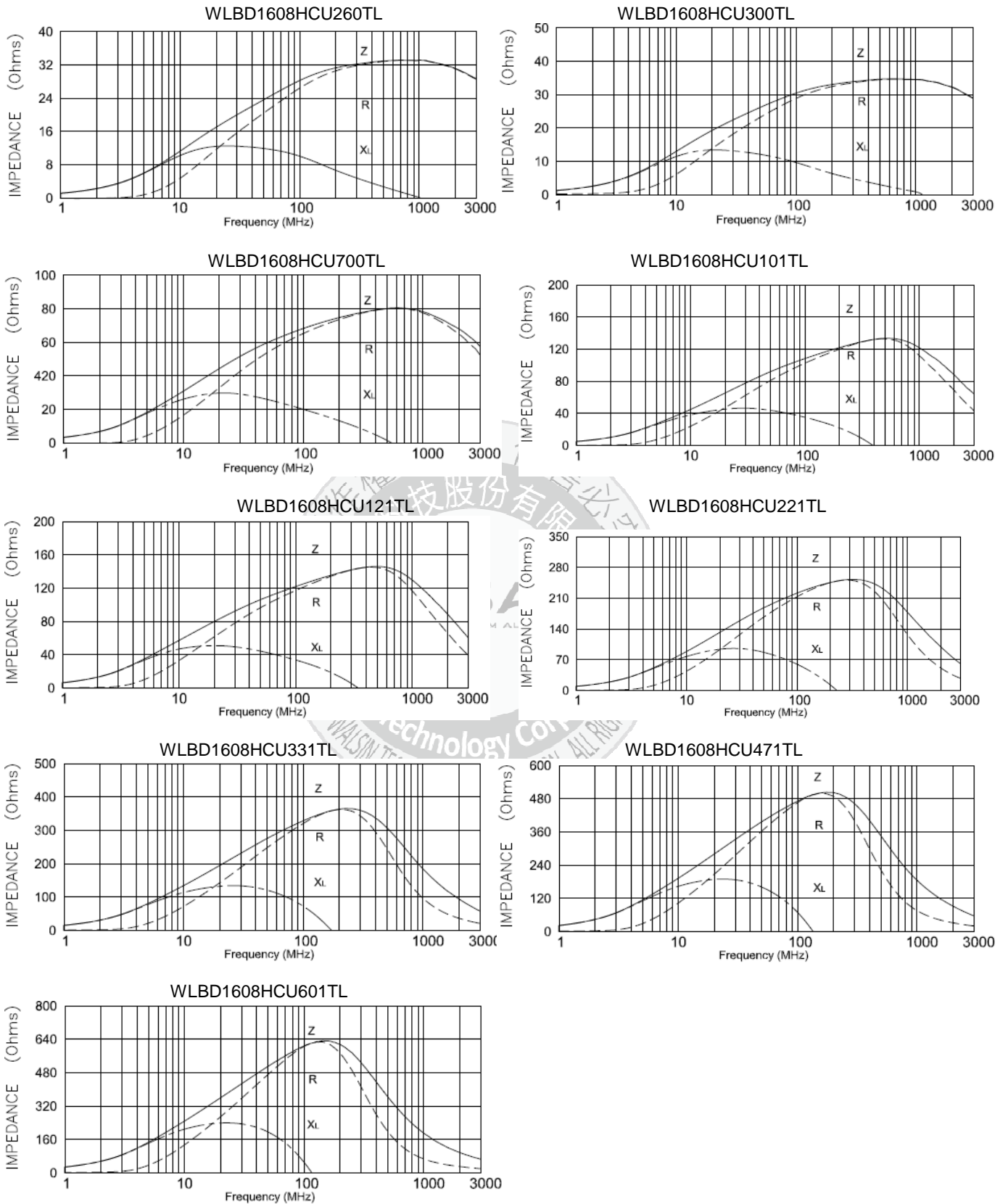

Packaging Specification  
Reel Dimension

Unit: mm

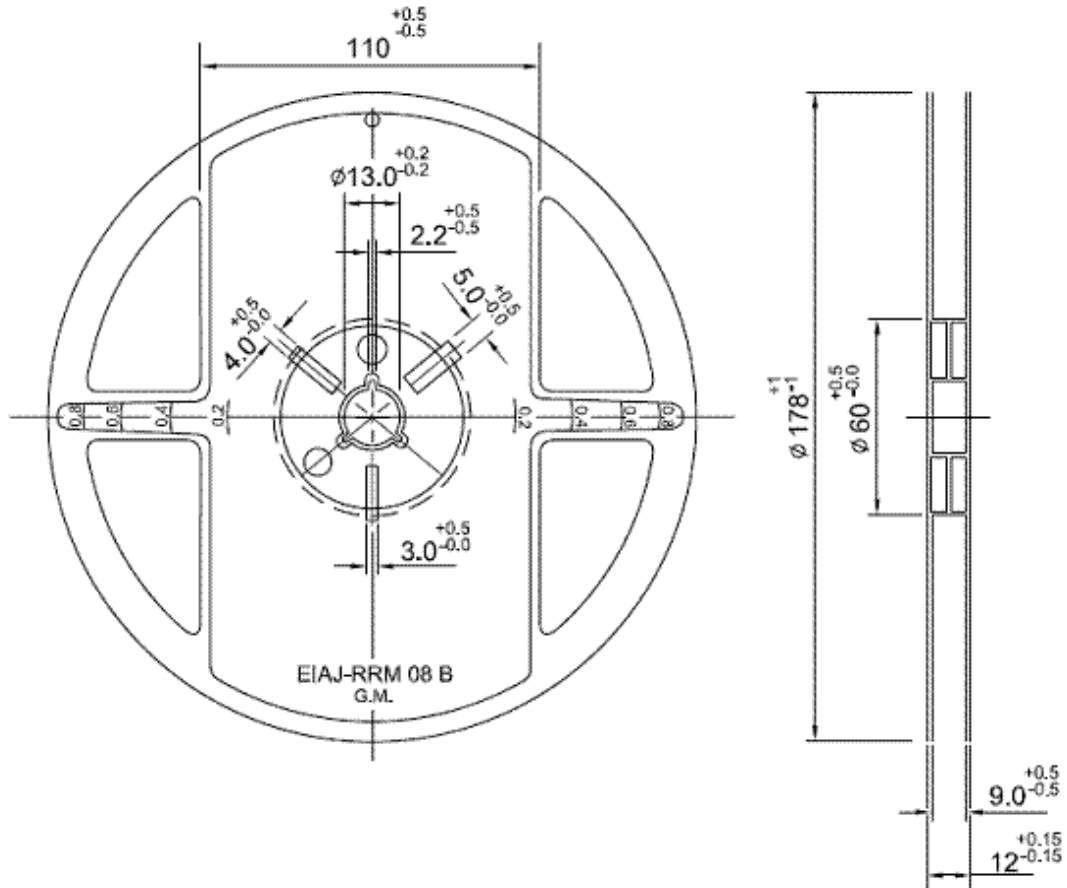

	Reel Packaging Quantity								
PART SIZE (EIA SIZE)	<b>0603</b> <b>(0201)</b>	<b>1005</b> <b>(0402)</b>	<b>1608</b> <b>(0603)</b>	<b>2012</b> <b>(0805)</b>	<b>**2012(T12)</b> <b>(0805)</b>	<b>3216</b> <b>(1206)</b>	<b>3225</b> <b>(1210)</b>	<b>4516</b> <b>(1806)</b>	<b>4532</b> <b>(1812)</b>
7" REEL Qty (Pcs)	15,000	10,000	4,000	4,000	3,000	3,000	2,000	2,000	1,000
inner box	5 reels	5 reels	5 reels	5 reels	5 reels	5 reels	5 reels	4 reels	4 reels