

SPECIFICATION

- Part No. : **WLP.4958.12.4.A.02**
- Product Name : **12mm*12mm*4mm 4.9~5.8GHz Patch
Pin Fed
Embedded High Gain Antenna**
- Features : For Wi-Fi/WLAN/ISM/Public Safety/Zigbee
Industrial and Consumer Applications
High Gain 6dBi
RoHS Compliant ✓



1. Introduction

This 12mm*12mm*4mm 6dBi high gain 4.9~5.8GHz patch pin fed antenna is ideally suited for high performance industrial and consumer applications in Wi-fi, ISM, Public Safety, and Zigbee bands. It can also be placed anywhere on the device ground-plane, unlike most chip or loop antennas which need to be edge mounted. The antenna can be matched by a PI matching circuit, or by creating a custom tuned part for a specific layout configuration on a board.

Many module manufacturers specify peak gain limits for any antennas that are to be connected to that module. Those peak gain limits are based on free-space conditions. In practice, the peak gain of an antenna tested in free-space can degrade by at least 1 or 2dBi when put inside a device. So ideally you should go for a slightly higher peak gain antenna than mentioned on the module specification to compensate for this effect, giving you better performance.

Upon testing of any of our antennas with your device and a selection of appropriate layout, integration technique, or cable, Taoglas can make sure any of our antennas' peak gain will be below the peak gain limits. Taoglas can then issue a specification and/or report for the selected antenna in your device that will clearly show it complying with the peak gain limits, so you can be assured you are meeting regulatory requirements for that module.

For example, a module manufacturer may state that the antenna must have less than 2dBi peak gain, but you don't need to select an embedded antenna that has a peak gain of less than 2dBi in free-space. This will give you a less optimized solution. It is better to go for a slightly higher free-space peak gain of 3dBi or more if available. Once that antenna gets integrated into your device, performance will degrade below this 2dBi peak gain due to the effects of GND plane, surrounding components, and device housing. If you want to be absolutely sure, contact Taoglas and we will test. Choosing a Taoglas antenna with a higher peak gain than what is specified by the module manufacturer and enlisting our help will ensure you are getting the best performance possible without exceeding the peak gain limits.

2. Specification*

| No | Parameter | Specification |
|----|--|----------------------------------|
| 1 | Range of Receiving Frequency | 4900MHz to 5825MHz |
| 2 | Center Frequency | 5180MHz±5.0MHz |
| 3 | Bandwidth | 450 MHz @ Return Loss ≤-10dB |
| 4 | Polarization | Linear |
| 5 | VSWR | 1.5 max @ Center Frequency |
| 6 | Peak Gain | +6.0dBic typ. @ Center Frequency |
| 7 | Impedance | 50 Ohms |
| 8 | Dimensions | 12mm x 12mm x 4mm |
| 9 | Frequency Temperature Coefficient (τf) | 0 ± 20ppm / °C -40°C to +85°C |
| 10 | Operating Temperature | -40°C to +85°C |

Original Patch Specification measured on EVB 70*70mm, actual value depends on ground-plane and housing

3. Antenna Characteristics

3.1 Return Loss

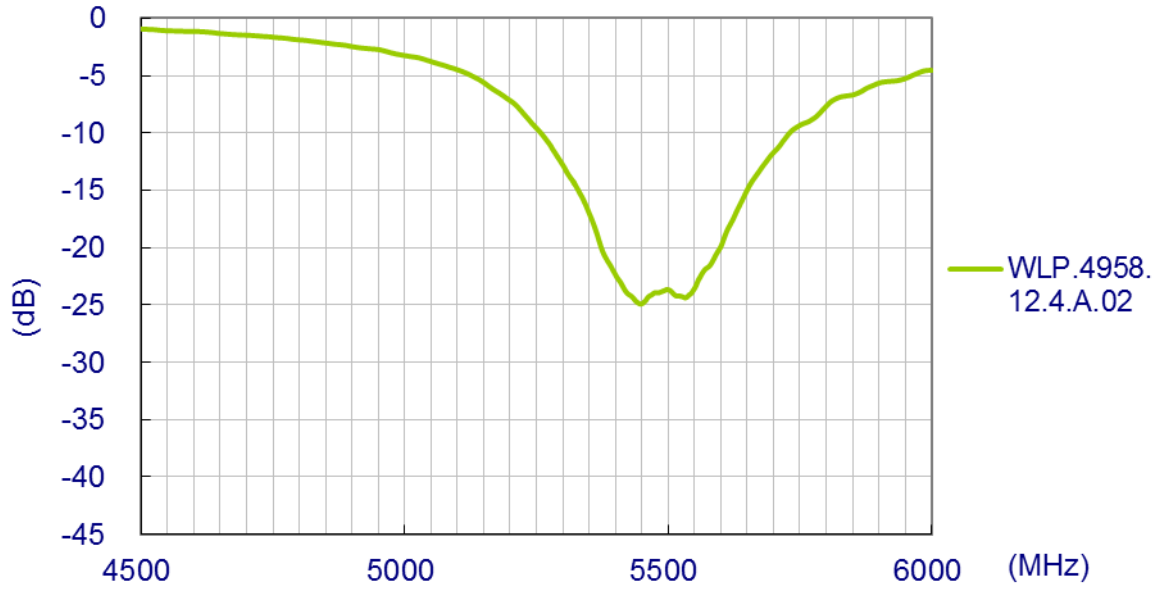

3.2 Efficiency Chart

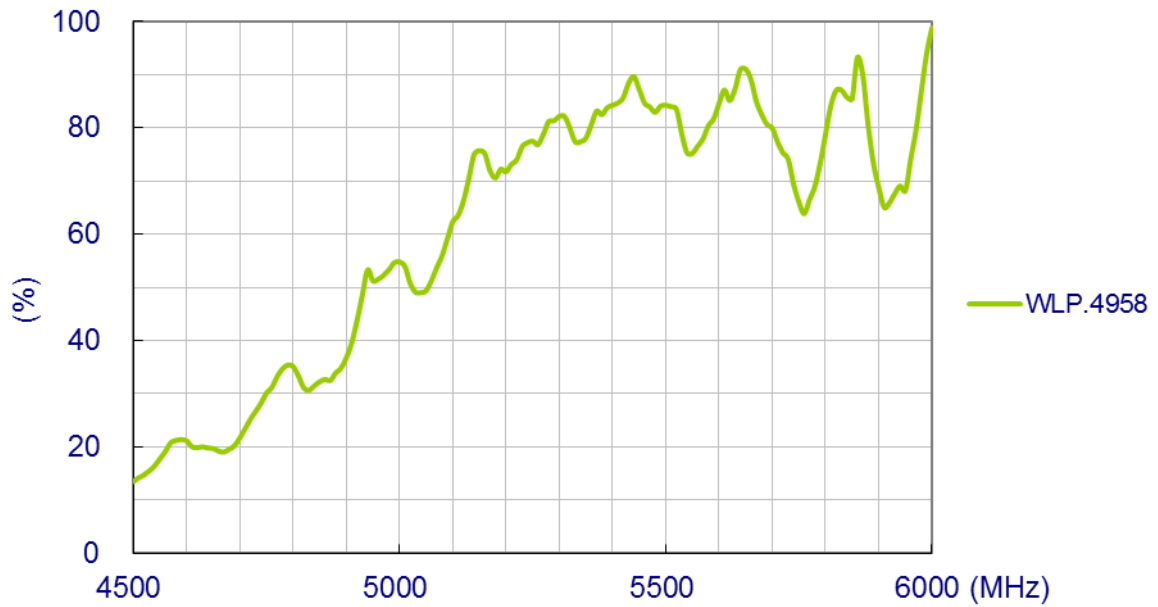

3.3 Average Gain

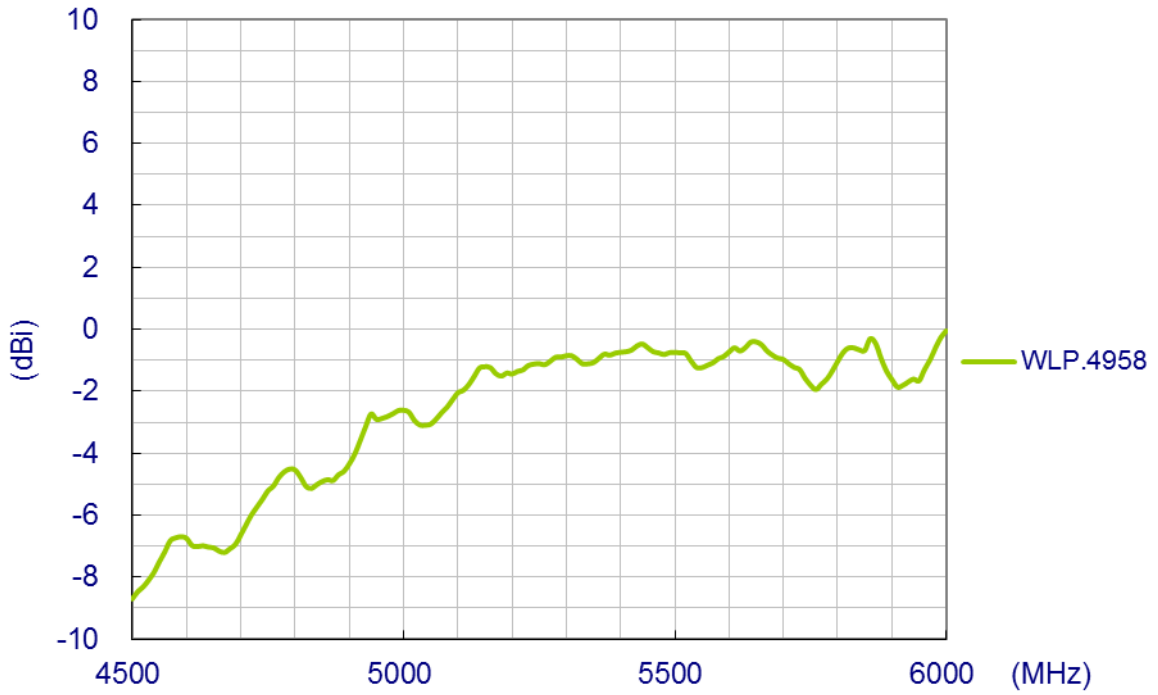

3.4 Peak Gain

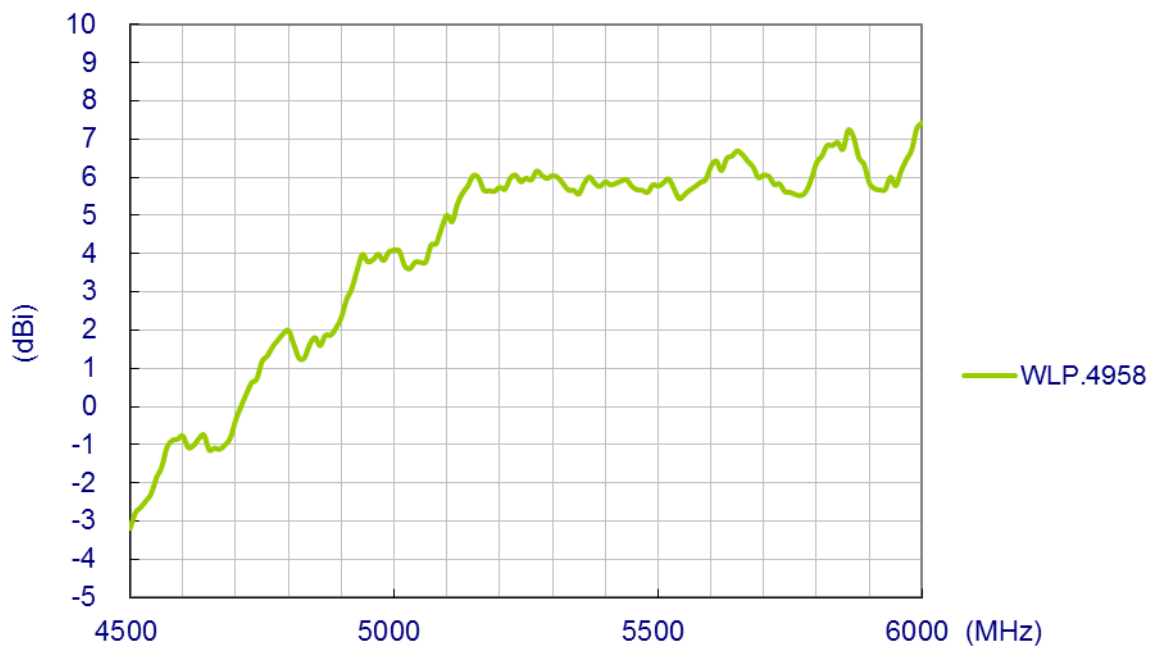

4.2D Radiation Patterns

4.1 Antenna Setup (70*70mm Ground Plane)

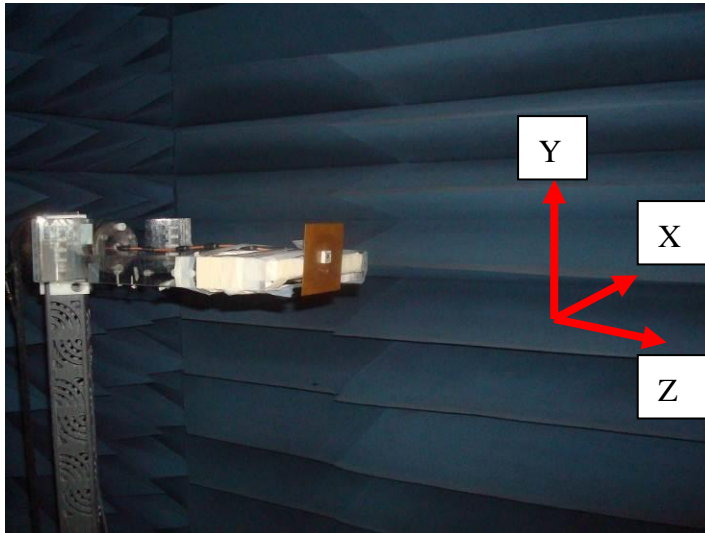

4.2 XY Plane Radiation

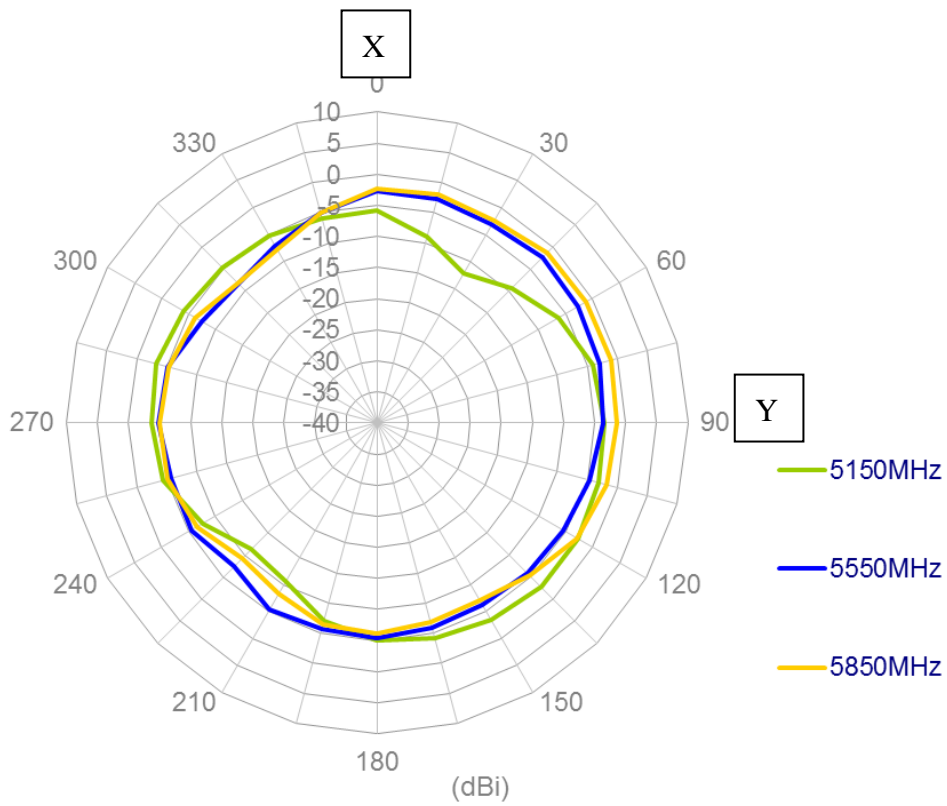

4.3 XZ Plane Radiation

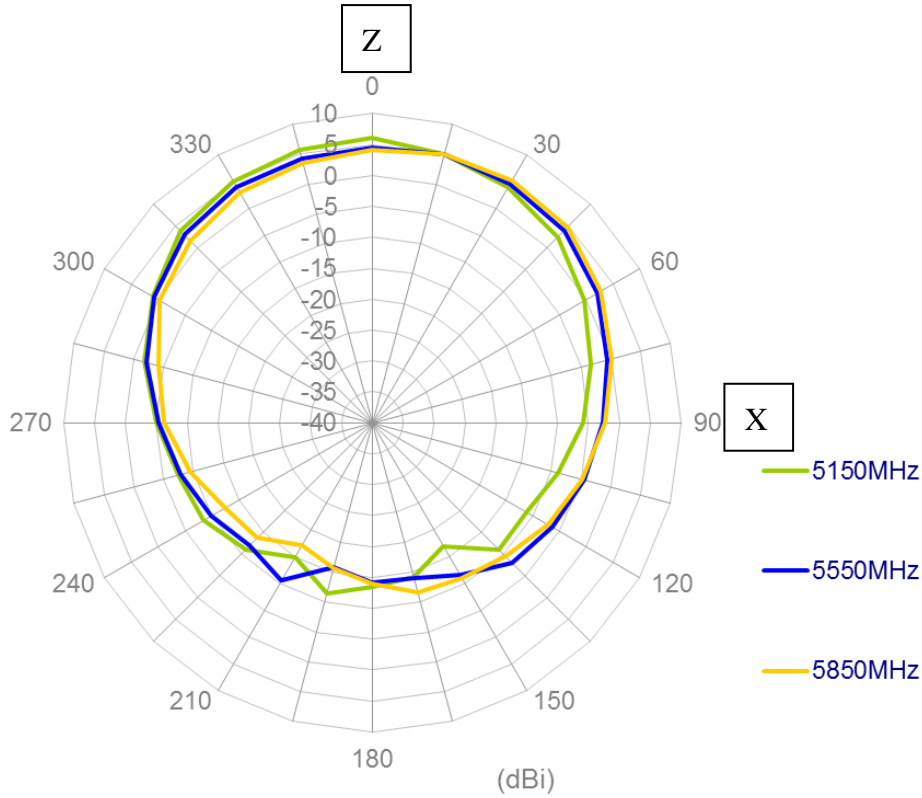

4.4 YZ Plane Radiation

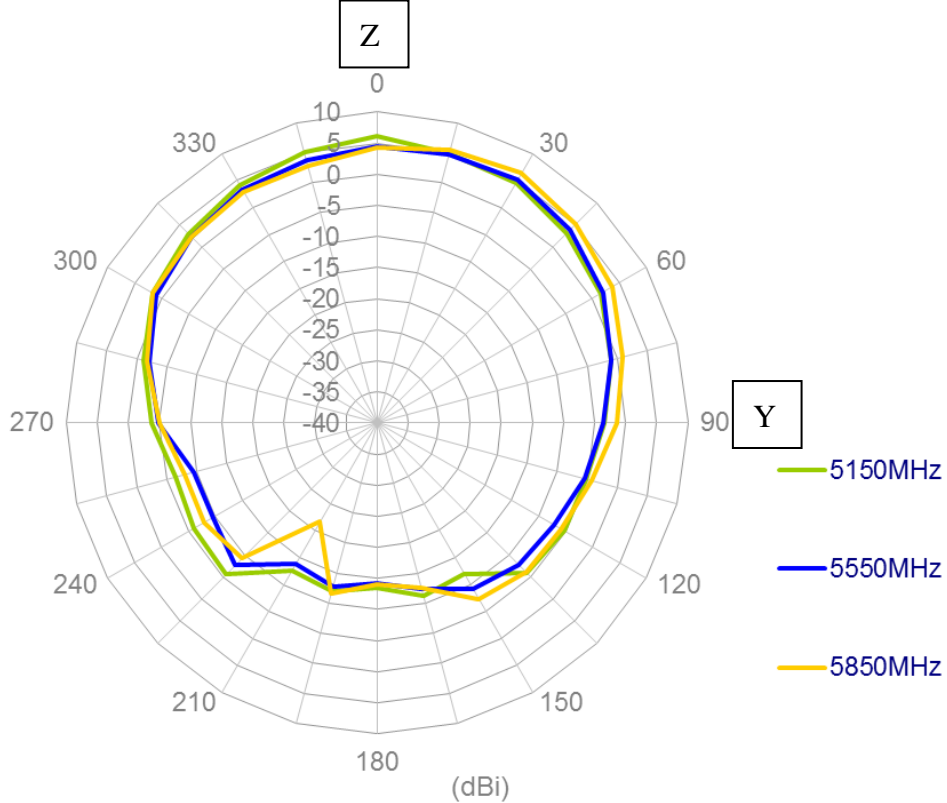

5. Drawing

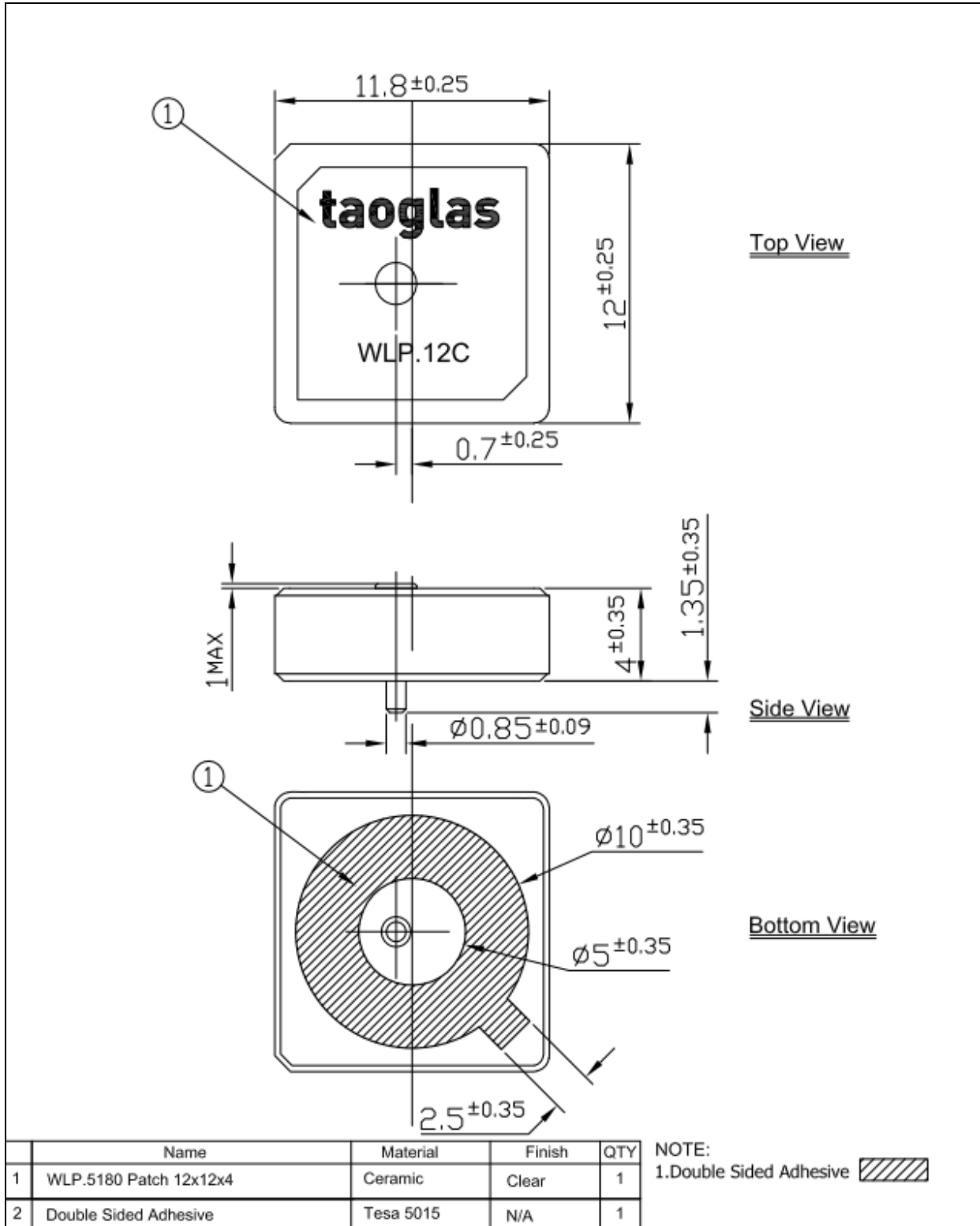

5.1 Layout Dimensions

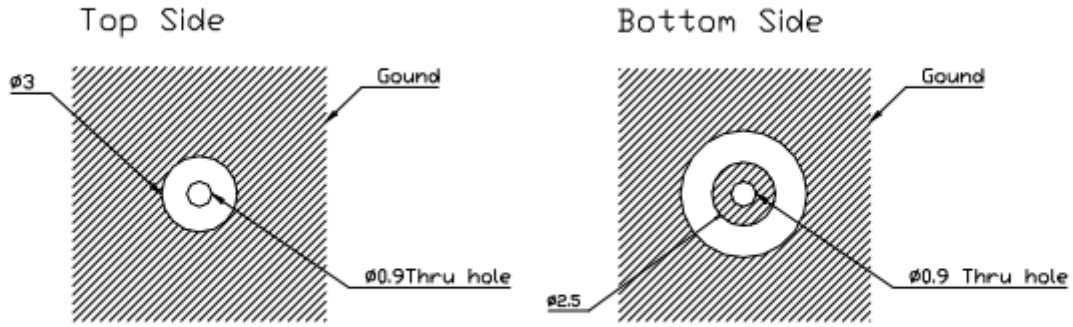

TOL: ± 0.20
UNIT: mm

5.2 Test Jig and Dimension

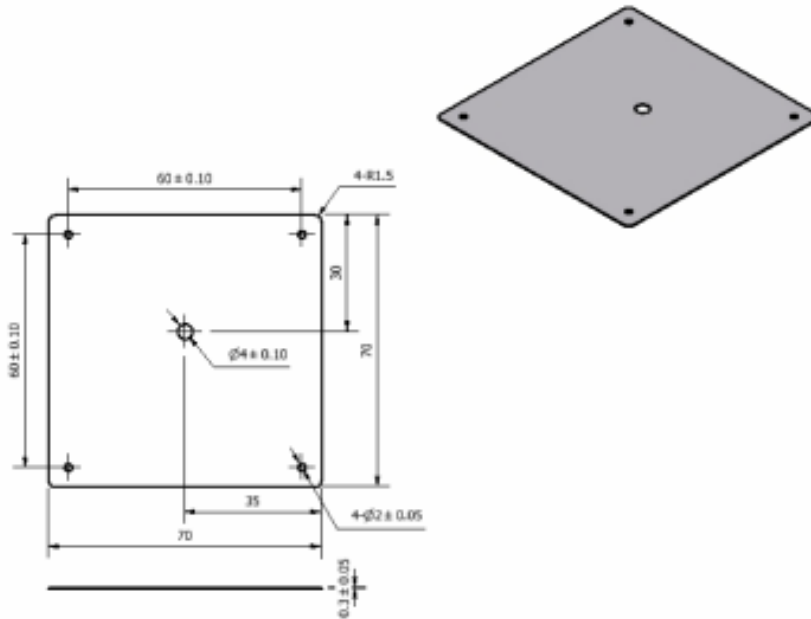

5.3 .Test Fixture Antenna Setup & Measurement

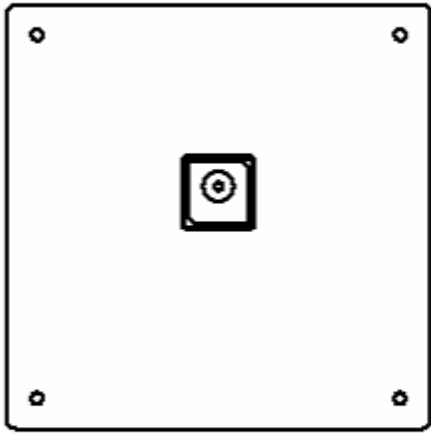

6. Packaging

Pieces per Inner Carton: 400

