

WLS28-2 LED Strip Light

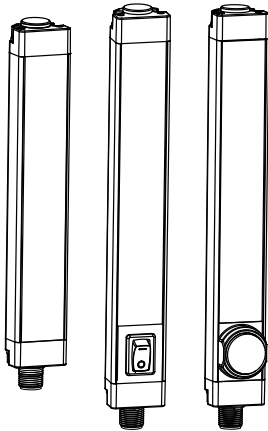

Datasheet



Banner's LED Strip Lights have sturdy aluminum housings, shatterproof windows, and impressive environmental ratings, making them an ideal general-purpose LED light for machine, enclosure, or other industrial lighting applications.

- Low-profile, space-saving design
- Rugged, water-resistant IP69K option
- Available in eight lengths from 145 mm to 1130 mm
- Lensed models or choice of clear or diffuse window
- Daisy chain power to multiple lights
- Optional snap clips for easy installation and repositioning
- Capability to dim lights using the wiring pinout (Hi/Lo/Off)
- Models with Hi/Lo/Off switch available
- Automatic temperature protection built into the unit. Above °C, the light dims to manage heat and protect product lifetime
- Motion sensing models available



Note: When cascading lights, a model with an Hi/Lo/Off switch can be used to control the lights cascaded off the switched model.

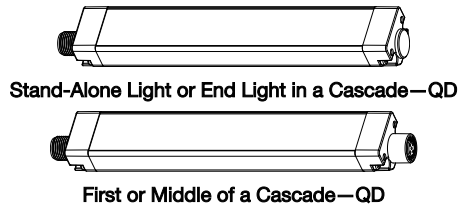
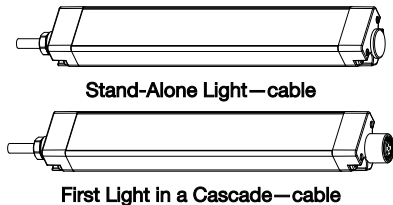

WLS28-2 Work Light Strips are available as either stand-alone models, or as cascade models that can be "daisy-chained" together for a continuous length of lighting, with a minimum of wiring.

Stand-alone models have cable or male QD fitting at one end for power connection, no connections at opposite end. A stand-alone model may be used as the last in the cascade series.

Cascade models have cable or male QD fitting at one end for power connection, female QD fitting at opposite end for connection to other lights in the cascade. Cascade models with cable end can only be used as the first light in the cascade series. A double-ended accessory cordset must be used between each pair of lights in a cascade.



Important: Lea el siguiente instructivo antes de operar el luminario. Por favor descargue desde www.bannerengineering.com toda la documentación técnica de los WLS28-2 LED Strip Light, disponibles en múltiples idiomas, para detalles del uso adecuado, aplicaciones, advertencias, y las instrucciones de instalación de estos dispositivos.



Important: Lisez les instructions suivantes avant d'utiliser le luminaire. Veuillez télécharger la documentation technique complète des WLS28-2 LED Strip Light sur notre site www.bannerengineering.com pour les détails sur leur utilisation correcte, les applications, les notes de sécurité et les instructions de montage.

Models

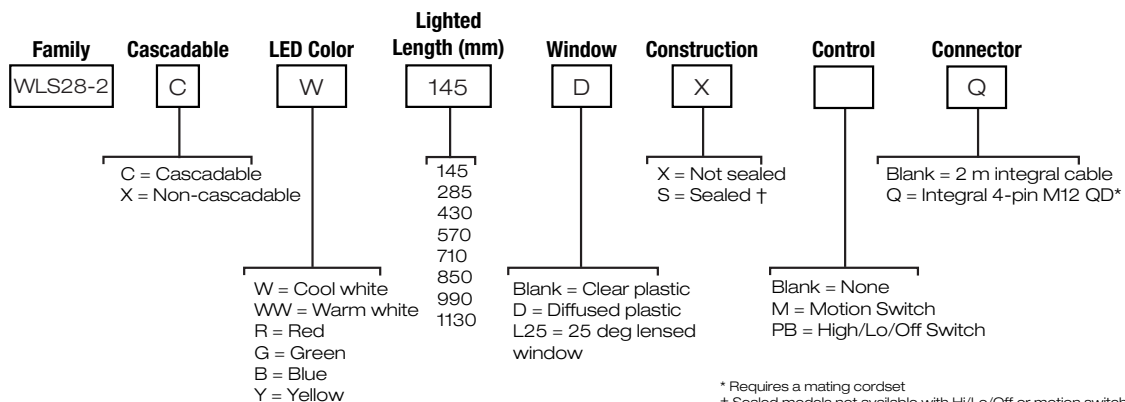

* Requires a mating cordset
† Sealed models not available with Hi/Lo/Off or motion switch



Table 1: IP50 Models

Non-Switch Models		HIGH/OFF/LOW Switch Models		Motion Switch Models		Lighted Length	Power Connector
Stand-Alone	Cascade	Stand-Alone	Cascade	Stand-Alone	Cascade		
WLS28-2XW145X	WLS28-2CW145X	WLS28-2XW145XPB	WLS28-2CW145XPB	WLS28-2XW145XM	WLS28-2CW145XM	145 mm	2 m (6.5 ft) cable
WLS28-2XW285X	WLS28-2CW285X	WLS28-2XW285XPB	WLS28-2CW285XPB	WLS28-2XW285XM	WLS28-2CW285XM	285 mm	
WLS28-2XW430X	WLS28-2CW430X	WLS28-2XW430XPB	WLS28-2CW430XPB	WLS28-2XW430XM	WLS28-2CW430XM	430 mm	
WLS28-2XW570X	WLS28-2CW570X	WLS28-2XW570XPB	WLS28-2CW570XPB	WLS28-2XW570XM	WLS28-2CW570XM	570 mm	
WLS28-2XW710X	WLS28-2CW710X	WLS28-2XW710XPB	WLS28-2CW710XPB	WLS28-2XW710XM	WLS28-2CW710XM	710 mm	
WLS28-2XW850X	WLS28-2CW850X	WLS28-2XW850XPB	WLS28-2CW850XPB	WLS28-2XW850XM	WLS28-2CW850XM	850 mm	
WLS28-2XW990X	WLS28-2CW990X	WLS28-2XW990XPB	WLS28-2CW990XPB	WLS28-2XW990XM	WLS28-2CW990XM	990 mm	
WLS28-2XW1130X	WLS28-2CW1130X	WLS28-2XW1130XPB	WLS28-2CW1130XPB	WLS28-2XW1130XM	WLS28-2CW1130XM	1130 mm	

Integral 2 m (6.5 ft) unterminated cable models are listed. To order the 4-pin M12/Euro-style integral quick disconnect model, add the suffix "Q" to the model number. For example, WLS28-2XW285XQ.

Table 2: IP67/IP69K Models

Model		Lighted Length	Connector
Stand-Alone	Cascade		
WLS28-2XW145S	WLS28-2CW145S	145 mm	2 m (6.5 ft) cable
WLS28-2XW285S	WLS28-2CW285S	285 mm	
WLS28-2XW430S	WLS28-2CW430S	430 mm	
WLS28-2XW570S	WLS28-2CW570S	570 mm	
WLS28-2XW710S	WLS28-2CW710S	710 mm	
WLS28-2XW850S	WLS28-2CW850S	850 mm	
WLS28-2XW990S	WLS28-2CW990S	990 mm	
WLS28-2XW1130S	WLS28-2CW1130S	1130 mm	

Integral 2 m (6.5 ft) unterminated cable models are listed. To order the 4-pin M12/Euro-style integral quick disconnect model, add the suffix "Q" to the model number. For example, WLS28-2XW285SQ.

Wiring Diagram

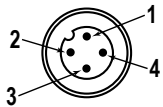
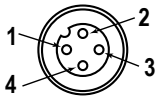
Male	Female	Pin	Wire Color	Connection
		1	Brown	12 V dc to 30 V dc
		3	Blue	dc common
		4	Black	Models without motion detection: Connect to 12 V dc to 30 V dc for 50% maximum intensity. For maximum intensity, leave the black wire floating or connected to common. Models with motion detection: Connect to 12 V dc to 30 V dc to bypass the motion detector switch
		2	White	Not used

Specifications

Supply Voltage and Current

12 V dc to 30 V dc
Use only with suitable Class 2 power supply (UL) or a SELV power supply (CE).

Supply Protection Circuitry

Protected against reverse polarity and transient voltages

Light Characteristics

Cool white
Color Temperature (CCT): 6500K (+500K, -400K)
Lumen output: 800 ($\pm 5\%$) per foot, typical at 25 °C (77 °F)
Luminous efficacy: 110 lumens/Watt typical at 24 V dc at 25 °C (77 °F)
CRI: 85, typical
Warm white: 3000K (+200K, -100K)
Green: 525 nm
Red: 618 nm
Yellow: 590 nm
Blue: 460 nm

Connections

Integral 4-pin M12/Euro-style quick disconnect (4-pin connecting cordset required); or 2 m (6.5 ft) integral PVC cable

Environmental Rating

IEC IP50 (non-sealed models) or IEC IP65, IEC IP67, IP69K per DIN 40050-9 (sealed models)

Vibration and Mechanical Shock

Vibration 10-55 Hz 1.0 mm p-p amplitude per IEC 60068-2-6
Shock 15G 11 ms duration, half sine wave per IEC 60068-2-27

Operating Temperature

Models without motion detection: -40 °C to +70 °C (-40 °F to +158 °F)
Models with motion detection: -20 °C to +60 °C (-4 °F to +140 °F)
Light output begins to decrease above 50 °C (122 °F) and will be approximately 65% of max intensity at 60 °C (140 °F) and 30% of max intensity at 70 °C (158 °F)

Storage Temperature

-40 °C to +70 °C (-40 °F to +158 °F)

LED Lifetime

Lumen Maintenance = L₇₀
 When operating within specifications, output will decrease less than 30% after 75,000 hours.

Push Button

II = 100% light intensity
 I = 50% light intensity
 0 = Off

Models with Motion Detection

Light turns off after approximately 60 seconds without detecting motion
 Range: 12 meters; ± 45° field of view
 Standby current: 170 µA

Construction

Clear anodized aluminum housing; painted zinc end caps; polycarbonate window on clear and diffuse plastic models; acrylic window on L25 models; zinc plated steel brackets

Mounting

(2) swivel brackets SMBWLS28RA included and (4) screws

Certifications



Sealed models only

Application Note

When connecting cascadable lights in series at 100% intensity, it is important not to exceed maximum current limitations:

Maximum length of light at 12 V dc: 1.4 m (4.6 ft)

Maximum length of light at 24 V dc: 3.0 m (9.8 ft)

Maximum length of light at 30 V dc: 3.1 m (10.2 ft)

At 50% intensity, double the lengths.



Note: Do not spray cable with high-pressure sprayer, or cable damage will result.

Table 3: Typical Current

Light Length	Typical Current			Max. Current A	Lumens ¹ (Typical @25 °C)					
	12 V dc	24 V dc	30 V dc		Cool White	Warm White	Green	Red	Yellow	Blue
145 mm	0.33 A	0.15 A	0.12 A	0.4	400	400	180	55	50	40
285 mm	0.66 A	0.30 A	0.24 A	0.8	800	800	360	110	100	80
430 mm	1.01 A	0.46 A	0.36 A	1.2	1200	1200	540	165	150	120
570 mm	1.36 A	0.61 A	0.48 A	1.6	1600	1600	720	220	200	160
710 mm	1.75 A	0.77 A	0.60 A	2.0	2000	2000	900	275	250	200
850 mm	2.13 A	0.92 A	0.73 A	2.4	2400	2400	1080	330	300	240
990 mm	2.59 A	1.08 A	0.85 A	2.8	2800	2800	1260	385	350	280
1130 mm	3.04 A	1.24 A	0.97 A	3.2	3200	3200	1440	440	400	320

Dimensions

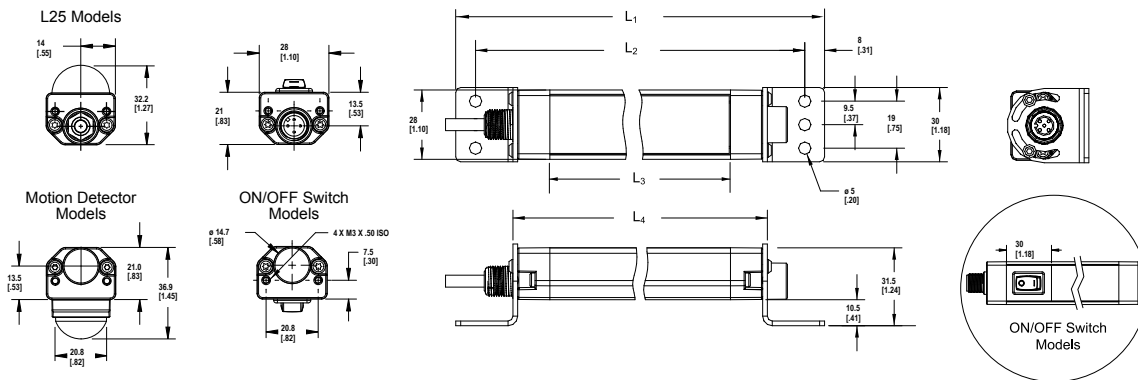

Dimensions are shown with the included SMBWLS28RA bracket.

Non-Switch Models					
IP50 Models	IP67/IP69K Models	L ₁	L ₂	L ₃	L ₄
WLS28-2..145X	WLS28-2..145S	221 mm (8.7 in)	205 mm (8.1 in)	145 mm (5.71 in)	175 mm (6.9 in)
WLS28-2..285X	WLS28-2..285S	362 mm (14.3 in)	346 mm (13.6 in)	286 mm (11.26 in)	316 mm (12.4 in)
WLS28-2..430X	WLS28-2..430S	503 mm (19.8 in)	487 mm (19.2 in)	427 mm (16.81 in)	457 mm (18.0 in)
WLS28-2..570X	WLS28-2..570S	644 mm (25.4 in)	628 mm (24.7 in)	568 mm (22.36 in)	598 mm (23.5 in)
WLS28-2..710X	WLS28-2..710S	785 mm (30.9 in)	769 mm (30.3 in)	709 mm (27.91 in)	739 mm (29.1 in)
WLS28-2..850X	WLS28-2..850S	926 mm (36.5 in)	910 mm (35.8 in)	850 mm (33.46 in)	880 mm (34.6 in)
WLS28-2..990X	WLS28-2..990S	1067 mm (42 in)	1051 mm (41.4 in)	991 mm (39.02 in)	1021 mm (40.2 in)
WLS28-2..1130X	WLS28-2..1130S	1208 mm (47.6 in)	1192 mm (46.9 in)	1132 mm (44.57 in)	1162 mm (45.7 in)

¹ Lumen values lowered by 25% on diffused window and 25 degree lensed models.

ON/OFF Switch Models				
Model	L ₁	L ₂	L ₃	L ₄
WLS28-2..145XPB	251 mm (9.9 in)	235 mm (9.3 in)	145 mm (5.71 in)	205 mm (8.1 in)
WLS28-2..285XPB	392 mm (15.4 in)	376 mm (14.8 in)	286 mm (11.26 in)	346 mm (13.6 in)
WLS28-2..430XPB	533 mm (21.0 in)	517 mm (20.4 in)	427 mm (16.81 in)	487 mm (19.2 in)
WLS28-2..570XPB	674 mm (26.5 in)	658 mm (25.9 in)	568 mm (22.36 in)	628 mm (24.7 in)
WLS28-2..710XPB	815 mm (32.1 in)	799 mm (31.5 in)	709 mm (27.91 in)	769 mm (30.3 in)
WLS28-2..850XPB	956 mm (37.6 in)	940 mm (37 in)	850 mm (33.46 in)	910 mm (35.8 in)
WLS28-2..990XPB	1097 mm (43.2 in)	1081 mm (42.6 in)	991 mm (39.02 in)	1051 mm (41.4 in)
WLS28-2..1130XPB	1238 mm (48.7 in)	1222 mm (48.1 in)	1132 mm (44.57 in)	1192 mm (46.9 in)

Performance

Optical data shown below are for cool white models with a clear window only. To get lux and candela values for models with a diffuse window and/or other colors, multiply the values shown on the charts by the following factors:

Diffuse Window	Warm White	Green	Red	Yellow	Blue
0.75	1.000	0.450	0.138	0.125	0.100

145 mm Models

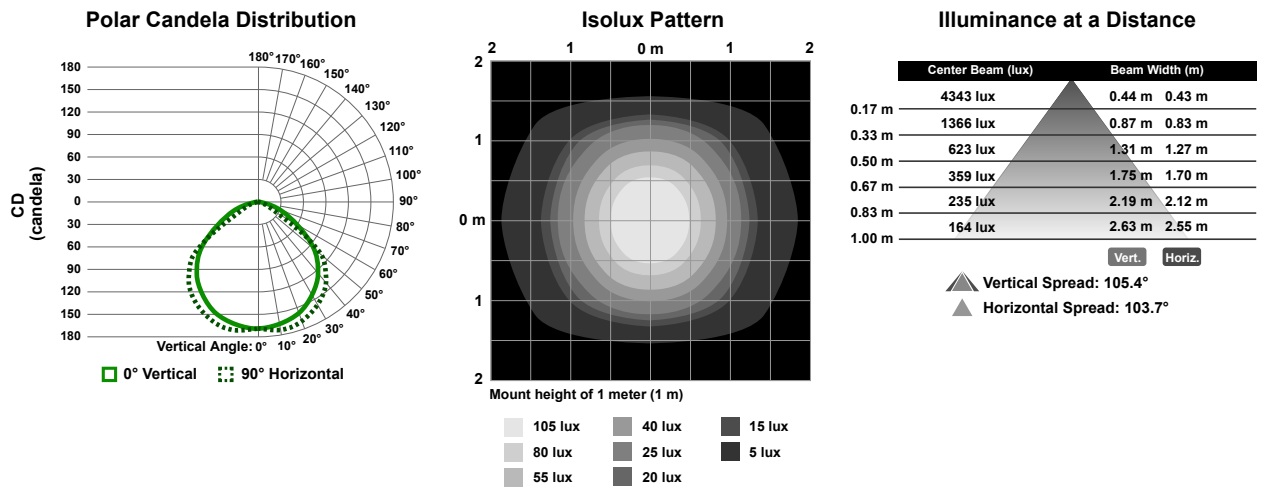

Figure 1. Clear Window

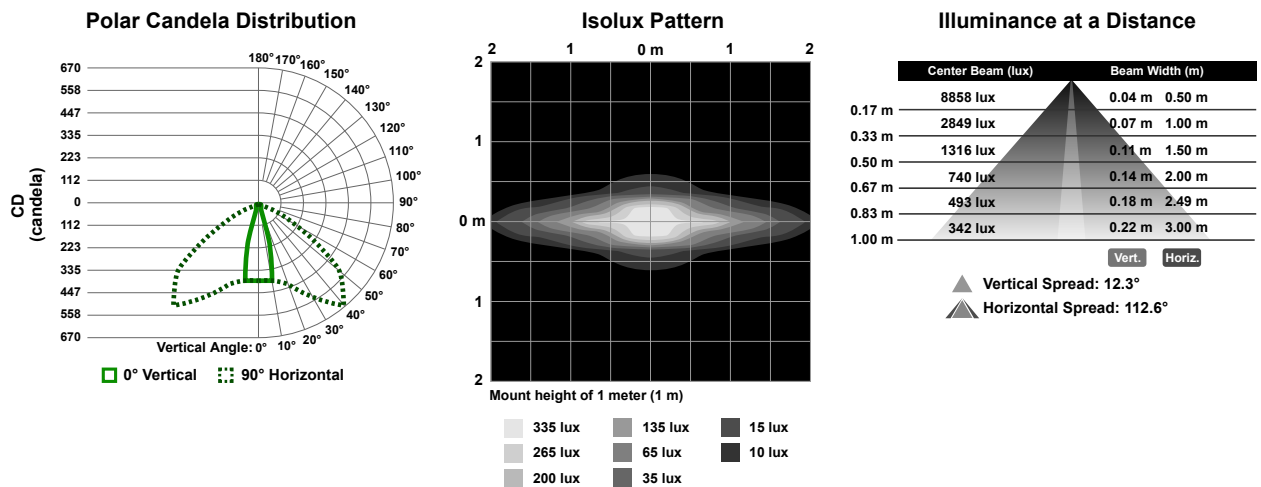

Figure 2. L25 Window

285 mm Models

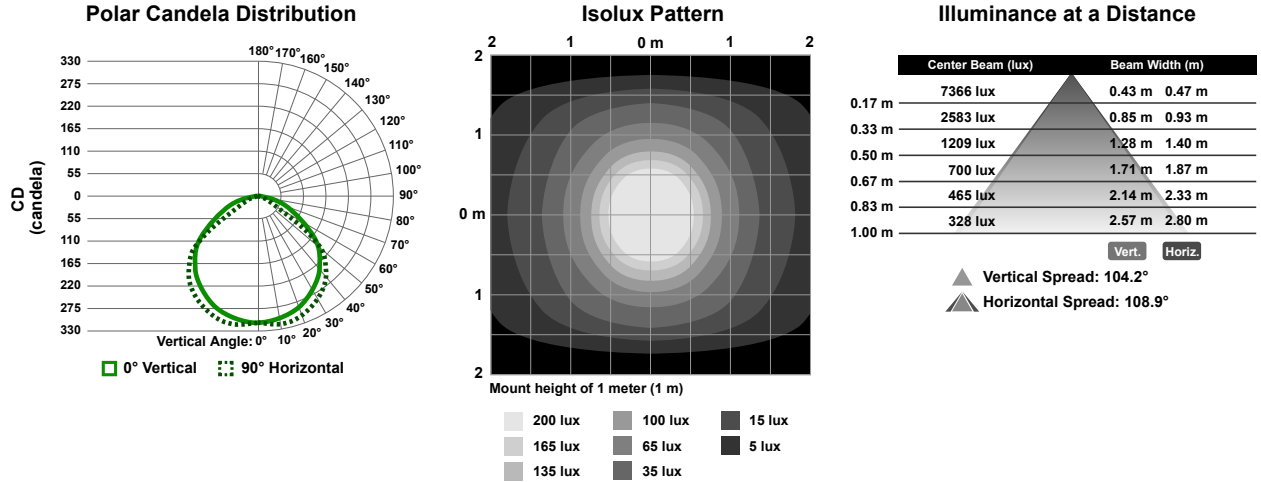

Figure 3. Clear Window

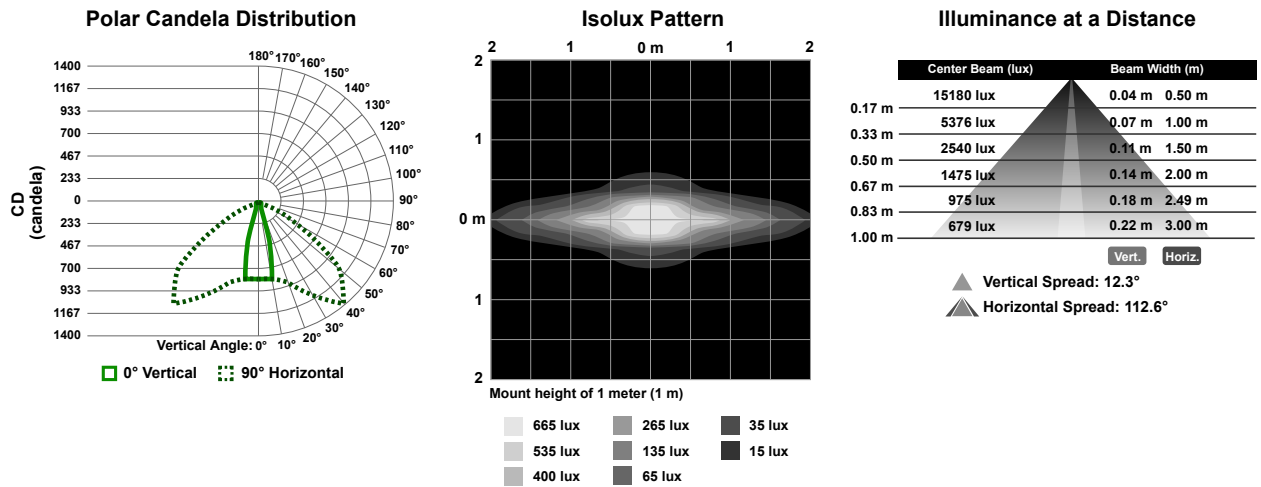

Figure 4. L25 Window

430 mm Models

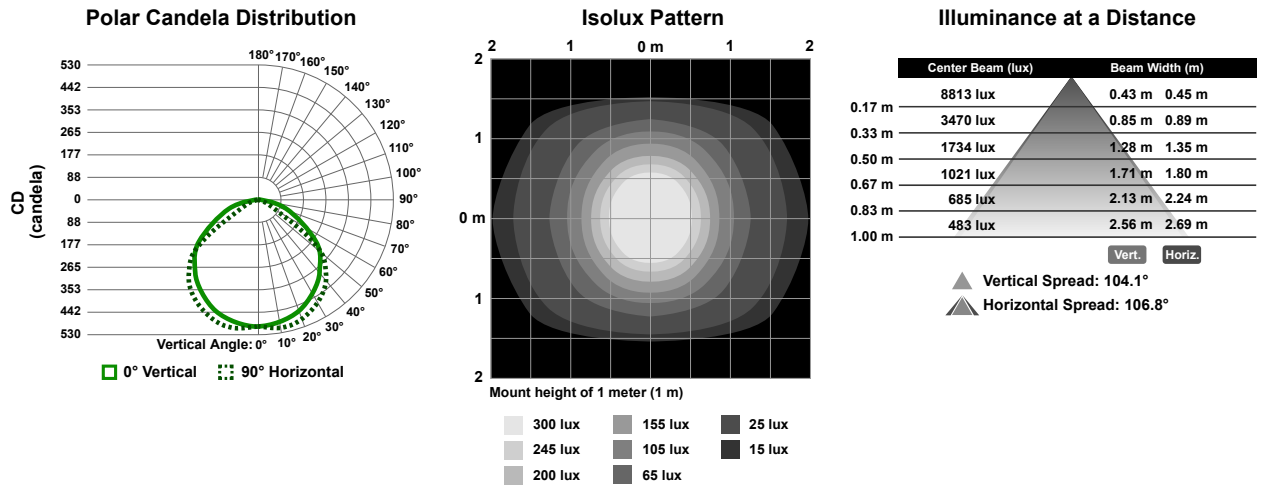

Figure 5. Clear Window

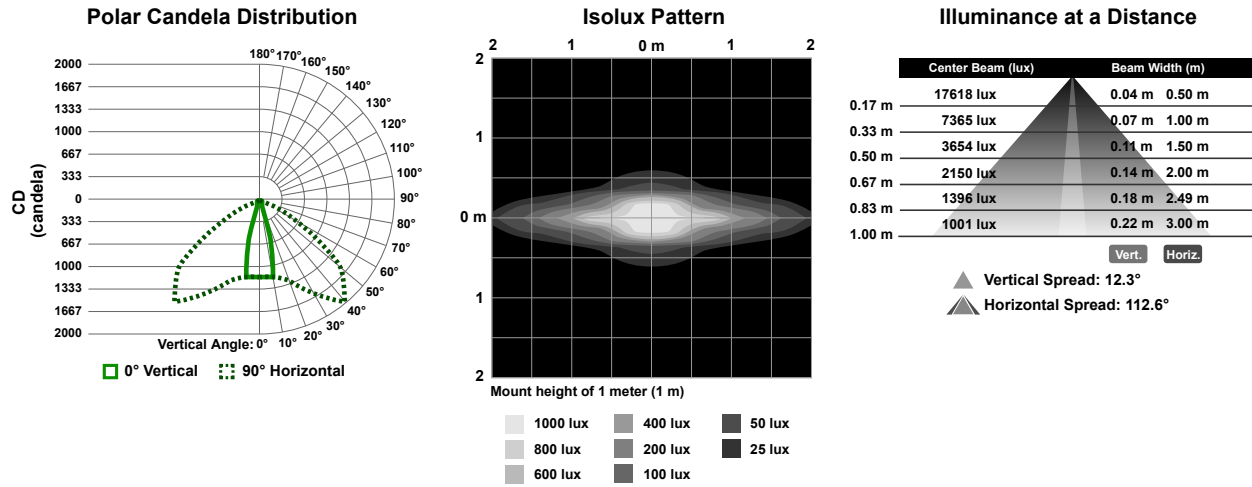

Figure 6. L25 Window

570 mm Models

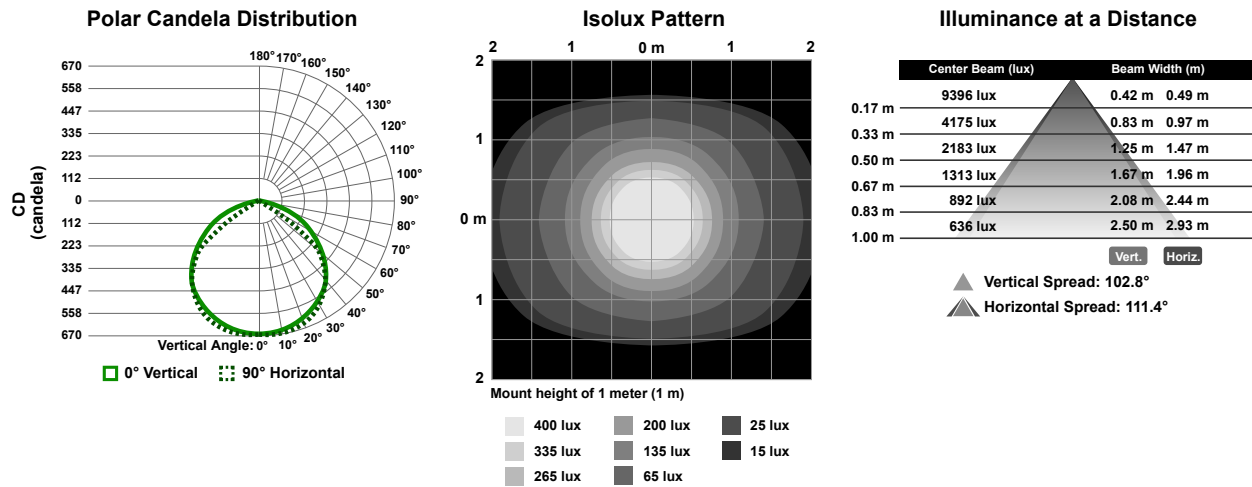

Figure 7. Clear Window

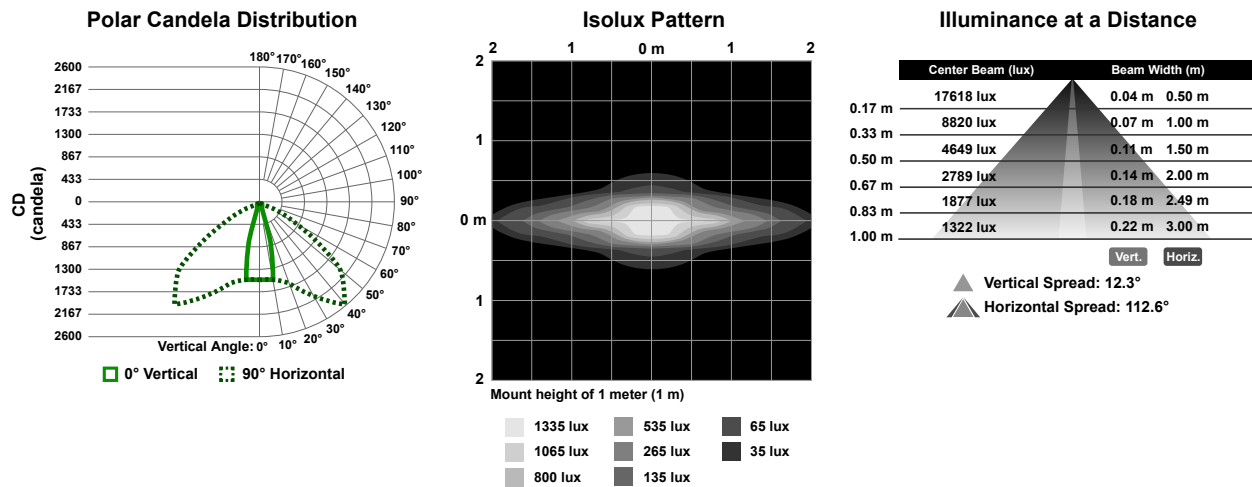

Figure 8. L25 Window

710 mm Models

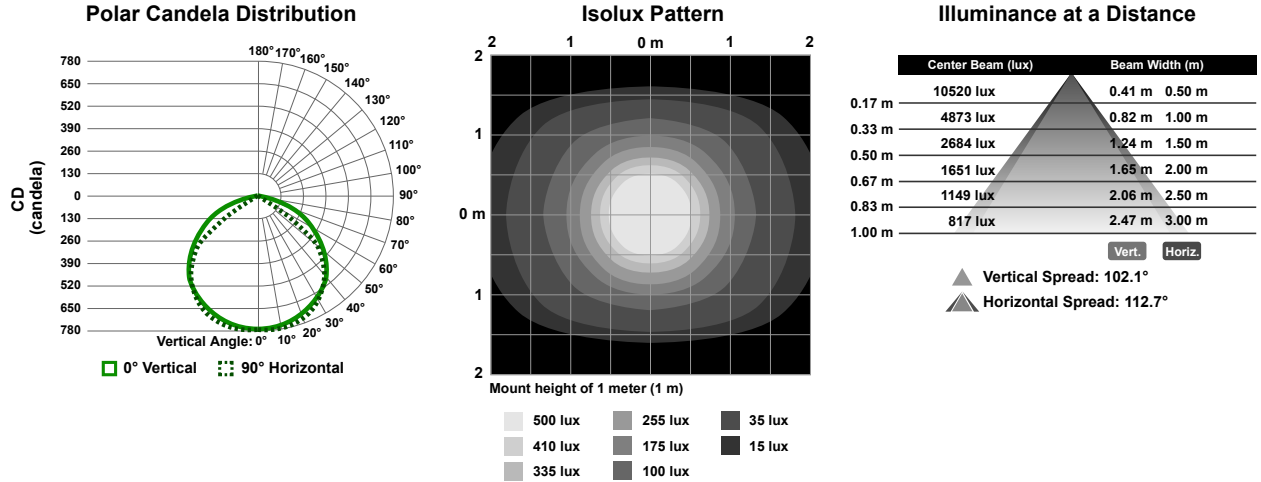

Figure 9. Clear Window

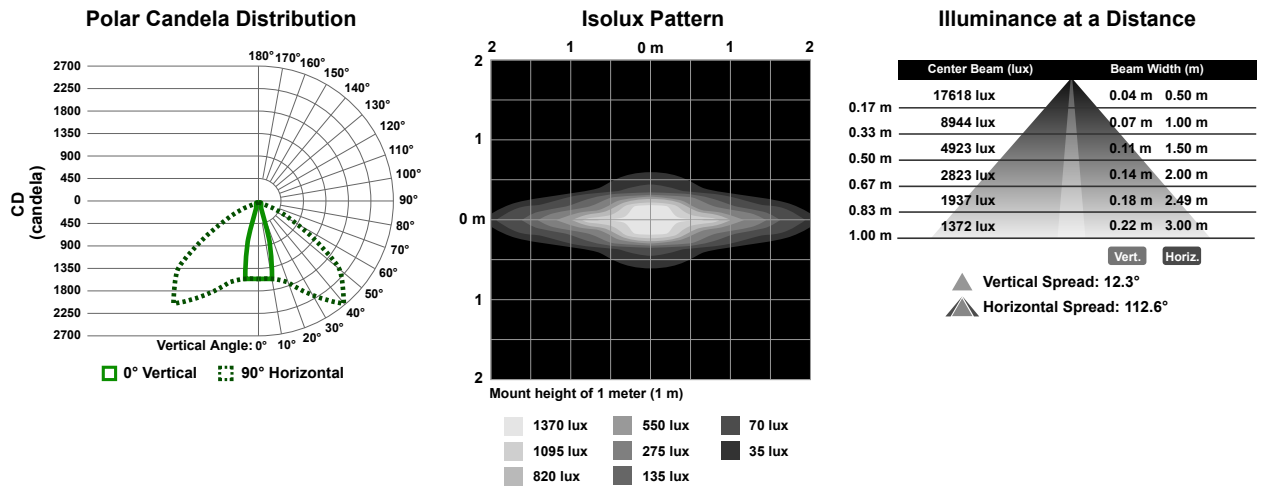

Figure 10. L25 Window

850 mm Models

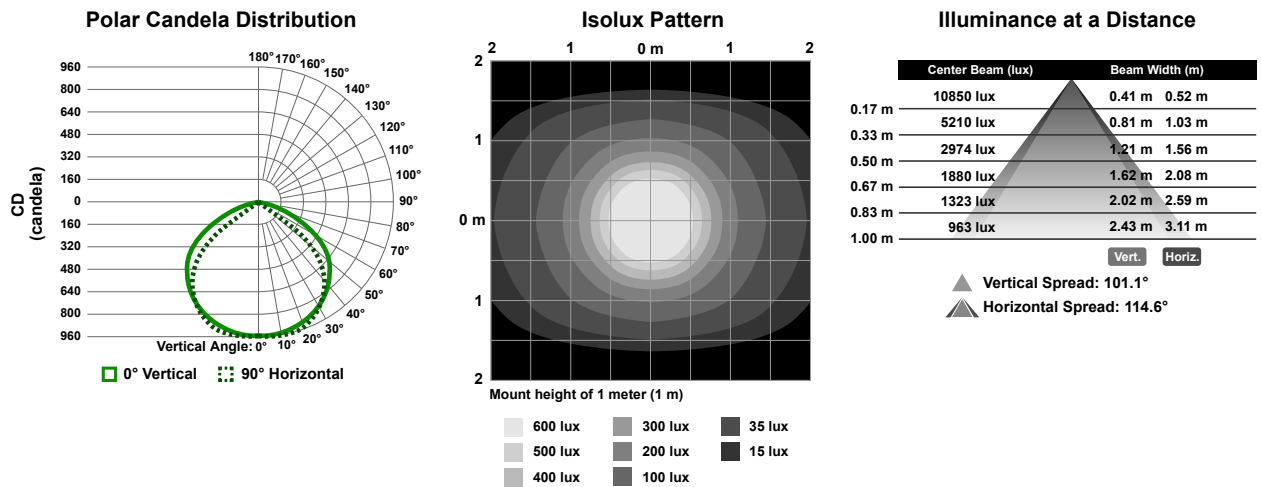

Figure 11. Clear Window

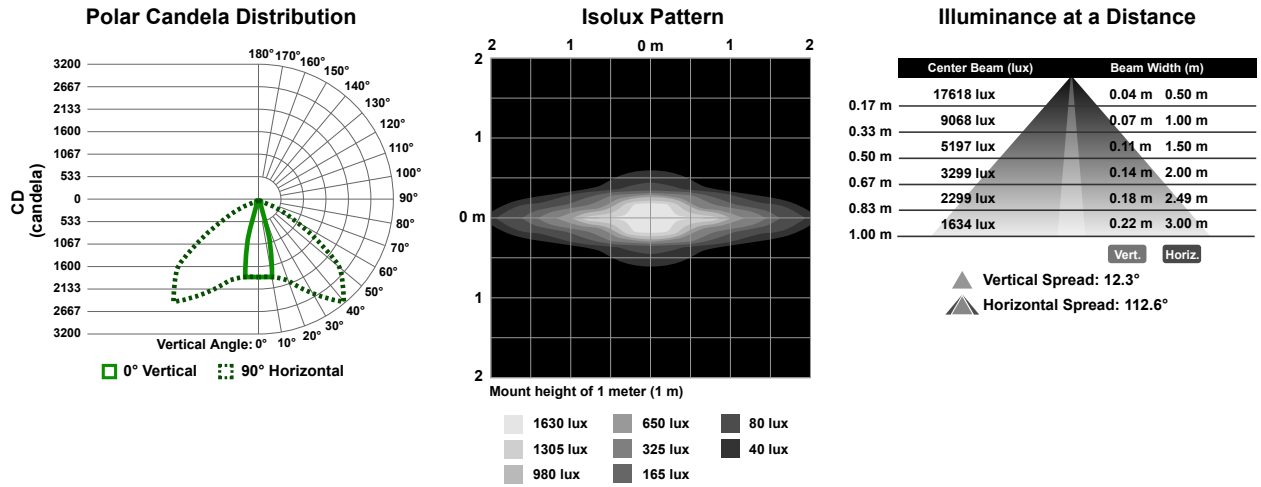

Figure 12. L25 Window

990 mm Models

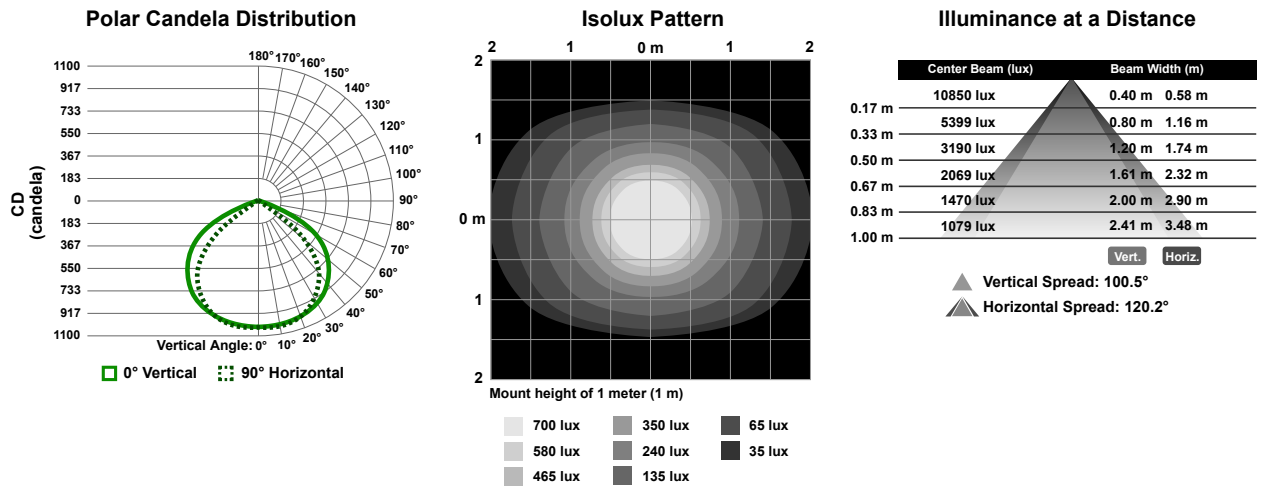

Figure 13. Clear Window

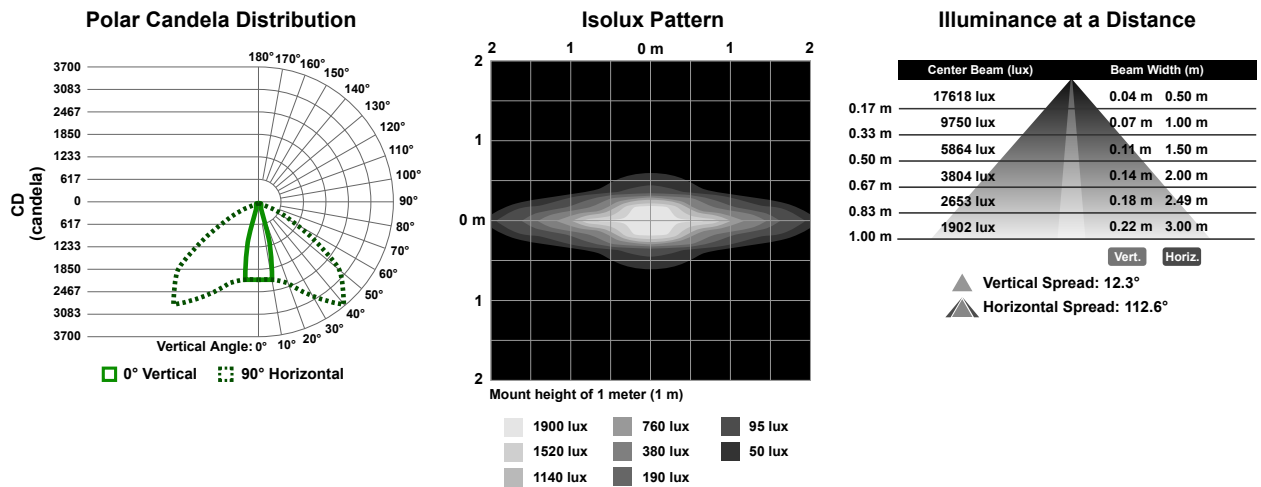

Figure 14. L25 Window

1130 mm Models

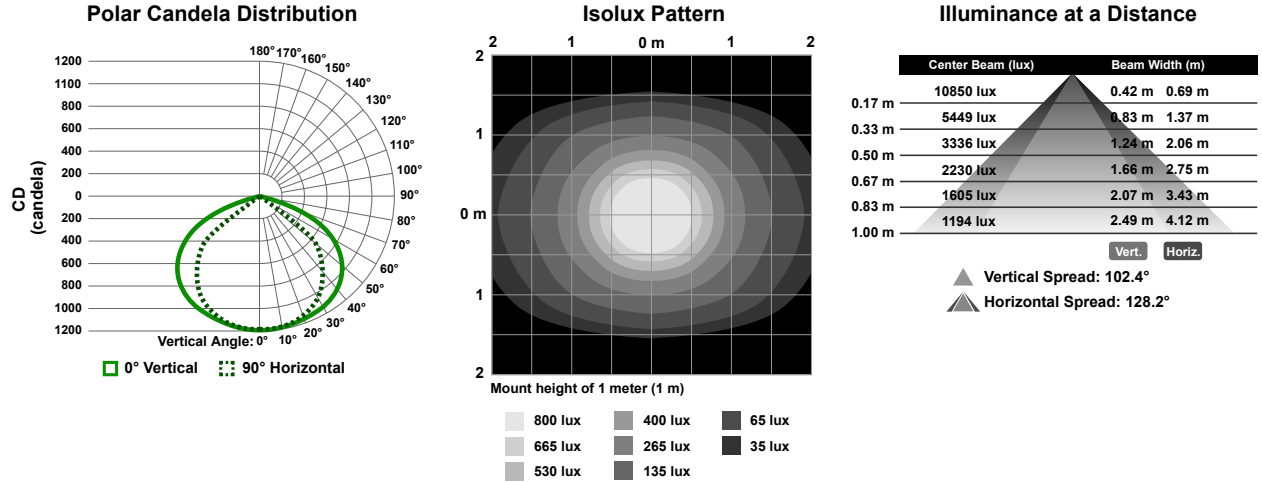

Figure 15. Clear Window

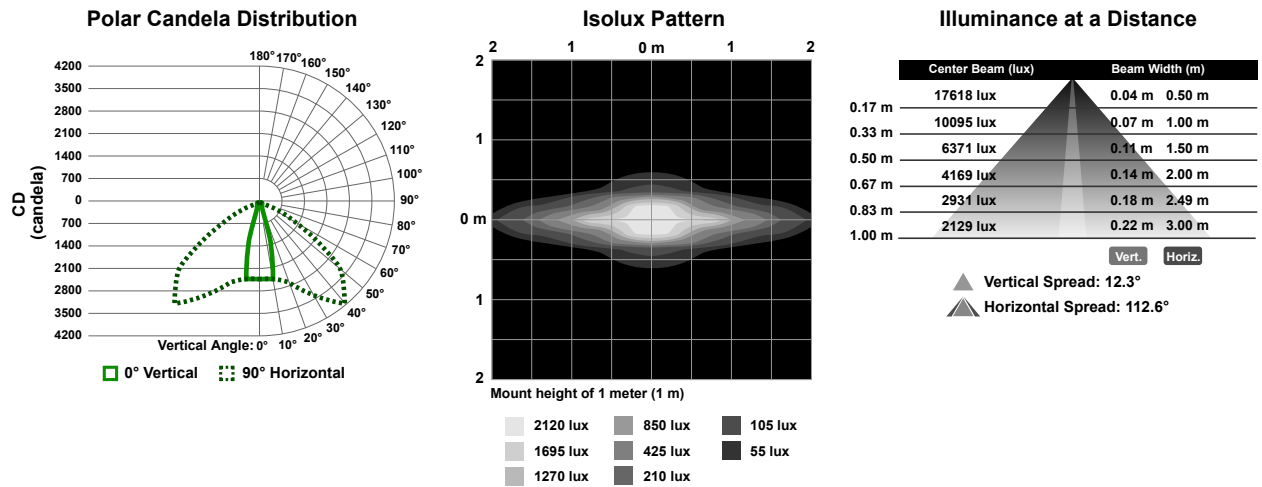

Figure 16. L25 Window

Accessories

Cordsets

Use single-ended cordsets between the power source and the QD connection of a stand-alone light or the first light in a cascade. Use double-ended cordsets between lights in a cascade.

4-Pin Threaded M12/Euro-Style Cordsets—Single Ended				
Model	Length	Style	Dimensions	Pinout (Female)
MQDC-406	1.83 m (6 ft)	Straight		
MQDC-415	4.57 m (15 ft)			
MQDC-430	9.14 m (30 ft)			
MQDC-450	15.2 m (50 ft)			

1 = Brown
2 = White
3 = Blue
4 = Black

4-Pin Threaded M12/Euro-Style Cordsets—Single Ended				
Model	Length	Style	Dimensions	Pinout (Female)
MQDC-406RA	1.83 m (6 ft)	Right-Angle		
MQDC-415RA	4.57 m (15 ft)			
MQDC-430RA	9.14 m (30 ft)			
MQDC-450RA	15.2 m (50 ft)			

4-Pin Threaded M12/Euro-Style Cordsets—Double Ended				
Model	Length	Style	Dimensions	Pinout
MQDEC-401SS	0.31 m (1 ft)	Male Straight/Female Straight		Female
MQDEC-403SS	0.91 m (3 ft)			
MQDEC-406SS	1.83 m (6 ft)			Male
MQDEC-412SS	3.66 m (12 ft)			
MQDEC-420SS	6.10 m (20 ft)			
MQDEC-430SS	9.14 m (30 ft)			
MQDEC-450SS	15.2 m (50 ft)			1 = Brown 2 = White 3 = Blue 4 = Black

4-Pin Threaded M12/Euro-Style Splitter Cordsets—Flat Junction				
Model	Branches (Female)	Trunk (Male)	Pinout	
CSB-M1240M1240	No branch	No trunk		
CSB-M1240M1241	2 x 0.30 m (1 ft)	No trunk		
CSB-M1241M1241		0.30 m (1 ft)		
CSB-M1248M1241		2.50 m (8 ft)		
CSB-M12415M1241		4.57 m (15 ft)		
CSB-M12425M1241		7.60 m (25 ft)		
CSB-UNT425M1241				
			1 = Brown 2 = White 3 = Blue 4 = Black	

Brackets

SMBWLS28RA

The bracket kit is available as a replacement for the one that comes with the Work Light Strip. The kit contains two end brackets and four screws.

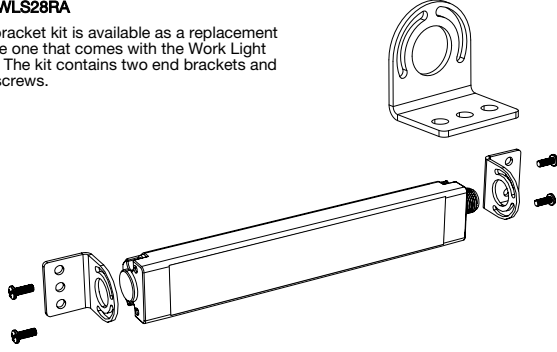

SMBWLS28SM

This kit allows the light to be mounted at a right angle to the mounting surface. The kit contains two end brackets and four screws.

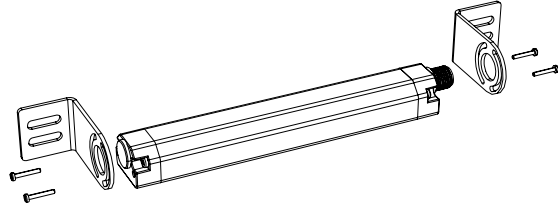

SMBWLS28SP

- Stainless steel snap bracket kit
- Includes two brackets

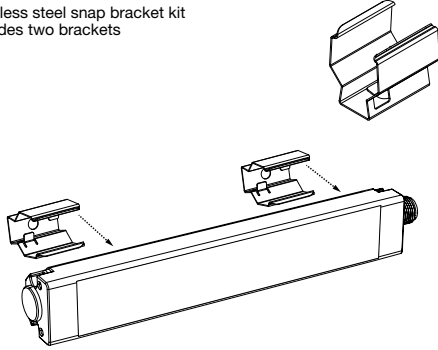

SMH1316

This kit allows the light to be mounted to a 13/16-inch Unistrut channel. The kit includes:

- #10-32 spring nuts (qty 2)
- #10-32 socket head cap screws (qty 2)
- #10 lock washers (qty 2)

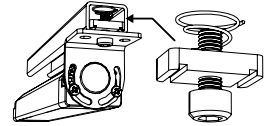

SMBWLSMAG

Magnetic mounting bracket for easy attachment to steel surfaces

SMBWLSMAGR

Protective cover also available to prevent scratches to painted surfaces

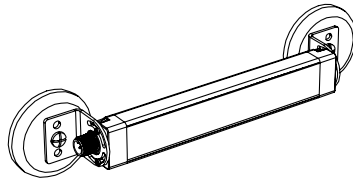

Banner Engineering Corp. Limited Warranty

Banner Engineering Corp. warrants its products to be free from defects in material and workmanship for one year following the date of shipment. Banner Engineering Corp. will repair or replace, free of charge, any product of its manufacture which, at the time it is returned to the factory, is found to have been defective during the warranty period. This warranty does not cover damage or liability for misuse, abuse, or the improper application or installation of the Banner product.

THIS LIMITED WARRANTY IS EXCLUSIVE AND IN LIEU OF ALL OTHER WARRANTIES WHETHER EXPRESS OR IMPLIED (INCLUDING, WITHOUT LIMITATION, ANY WARRANTY OF MERCHANTABILITY OR FITNESS FOR A PARTICULAR PURPOSE), AND WHETHER ARISING UNDER COURSE OF PERFORMANCE, COURSE OF DEALING OR TRADE USAGE.

This Warranty is exclusive and limited to repair or, at the discretion of Banner Engineering Corp., replacement. **IN NO EVENT SHALL BANNER ENGINEERING CORP. BE LIABLE TO BUYER OR ANY OTHER PERSON OR ENTITY FOR ANY EXTRA COSTS, EXPENSES, LOSSES, LOSS OF PROFITS, OR ANY INCIDENTAL, CONSEQUENTIAL OR SPECIAL DAMAGES RESULTING FROM ANY PRODUCT DEFECT OR FROM THE USE OR INABILITY TO USE THE PRODUCT, WHETHER ARISING IN CONTRACT OR WARRANTY, STATUTE, TORT, STRICT LIABILITY, NEGLIGENCE, OR OTHERWISE.**

Banner Engineering Corp. reserves the right to change, modify or improve the design of the product without assuming any obligations or liabilities relating to any product previously manufactured by Banner Engineering Corp. Any misuse, abuse, or improper application or installation of this product or use of the product for personal protection applications when the product is identified as not intended for such purposes will void the product warranty. Any modifications to this product without prior express approval by Banner Engineering Corp will void the product warranties. All specifications published in this document are subject to change; Banner reserves the right to modify product specifications or update documentation at any time. Specifications and product information in English supersede that which is provided in any other language. For the most recent version of any documentation, refer to: www.bannerengineering.com.

For patent information, see www.bannerengineering.com/patents.

FCC Part 15 and CAN ICES-3 (B)/NMB-3(B)

This device complies with part 15 of the FCC Rules and CAN ICES-3 (B)/NMB-3(B). Operation is subject to the following two conditions:

1. This device may not cause harmful interference, and
2. This device must accept any interference received, including interference that may cause undesired operation.

This equipment has been tested and found to comply with the limits for a Class B digital device, pursuant to part 15 of the FCC Rules and CAN ICES-3 (B)/NMB-3(B). These limits are designed to provide reasonable protection against harmful interference in a residential installation. This equipment generates, uses and can radiate radio frequency energy and, if not installed and used in accordance with the instructions, may cause harmful interference to radio communications. However, there is no guarantee that interference will not occur in a particular installation. If this equipment does cause harmful interference to radio or television reception, which can be determined by turning the equipment off and on, the user is encouraged to try to correct the interference by one or more of the following measures:

- Reorient or relocate the receiving antenna.
- Increase the separation between the equipment and receiver.
- Connect the equipment into an outlet on a circuit different from that to which the receiver is connected.
- Consult the manufacturer.