



# Digi XBee<sup>®</sup> 3

RF Module

---

Hardware Reference Manual

## Revision history—90001543

---

| Revision | Date           | Description   |
|----------|----------------|---|
| P        | January 2020   | Added Mexican certifications.   |
| R        | April 2020     | Added weight and electrical characteristics. Updated the EU antenna section.                  |
| S        | July 2020      | Added graphics of attaching a device to a board. Added information on over-voltage detection. |
| T        | July 2021      | Added safety instructions and UKCA labeling requirements.                                     |
| U        | September 2021 | Updated Mexican certifications.   |

## Trademarks and copyright

Digi, Digi International, and the Digi logo are trademarks or registered trademarks in the United States and other countries worldwide. All other trademarks mentioned in this document are the property of their respective owners.

© 2021 Digi International Inc. All rights reserved.

## Disclaimers

Information in this document is subject to change without notice and does not represent a commitment on the part of Digi International. Digi provides this document “as is,” without warranty of any kind, expressed or implied, including, but not limited to, the implied warranties of fitness or merchantability for a particular purpose. Digi may make improvements and/or changes in this manual or in the product(s) and/or the program(s) described in this manual at any time.

## Warranty

To view product warranty information, go to the following website:

[www.digi.com/howtobuy/terms](http://www.digi.com/howtobuy/terms)

## Customer support

**Gather support information:** Before contacting Digi technical support for help, gather the following information:

- Product name and model
- Product serial number (s)
- Firmware version
- Operating system/browser (if applicable)
- Logs (from time of reported issue)

Trace (if possible)  
Description of issue  
Steps to reproduce

**Contact Digi technical support:** Digi offers multiple technical support plans and service packages. Contact us at +1 952.912.3444 or visit us at [www.digi.com/support](http://www.digi.com/support).

## Feedback

To provide feedback on this document, email your comments to

[techcomm@digi.com](mailto:techcomm@digi.com)

Include the document title and part number (Digi XBee® 3 RF Module Hardware Reference Manual, 90001543 U) in the subject line of your email.

# Contents

---

## Digi XBee® 3 RF Module Hardware Reference Manual

|                           |   |
|---------------------------|---|
| Safety instructions ..... | 8 |
| XBee modules .....        | 8 |

## General XBee 3 specifications

|   |    |
|---|----|
| General specifications .....              | 10 |
| Electrical characteristics .....          | 10 |
| Regulatory conformity summary .....       | 11 |
| Serial communication specifications ..... | 12 |
| UART pin assignments .....                | 12 |
| SPI pin assignments .....                 | 12 |
| GPIO specifications .....                 | 12 |
| Electro Static Discharge (ESD) .....      | 13 |

## IEEE 802.15.4-specific specifications

|  |    |
|--|----|
| Performance specifications .....             | 15 |
| Power requirements .....                     | 15 |
| Networking and security specifications ..... | 15 |
| Communication interface specifications ..... | 16 |

## Mechanical drawings

|  |    |
|--|----|
| XBee 3 surface-mount antennas .....              | 18 |
| XBee 3 surface-mount - U.FL/RF pad antenna ..... | 18 |
| XBee 3 surface-mount - embedded antenna .....    | 19 |
| XBee 3 micro antennas .....                      | 20 |
| XBee 3 micro (U.FL/RF Pad) .....                 | 20 |
| XBee 3 micro (chip antenna) .....                | 21 |
| XBee 3 through-hole antennas .....               | 22 |
| XBee 3 through-hole - PCB antenna .....          | 22 |
| XBee 3 through-hole - U.FL antenna .....         | 22 |
| XBee 3 through-hole - RPSMA antenna .....        | 23 |

## Pin signals

|   |    |
|---|----|
| Pin signals for the XBee 3 surface-mount module ..... | 25 |
| Pin signals for the XBee 3 micro module .....         | 28 |

|  |    |
|--|----|
| Pin signals for the XBee 3 through-hole module ..... | 31 |
| Recommended pin connections .....                    | 32 |

## Design notes

|   |    |
|---|----|
| Power supply design .....                                   | 34 |
| Board layout .....  | 34 |
| Antenna performance .....                                   | 34 |
| Design notes for PCB antenna and chip antenna devices ..... | 35 |
| Surface-mount embedded antenna keepout area .....           | 35 |
| XBee 3 Micro chip antenna keepout area .....                | 36 |
| Through-hole embedded antenna keepout area .....            | 37 |
| Design notes for RF pad devices .....                       | 38 |
| Copper keepout for test points .....                        | 40 |

## Regulatory information

|  |    |
|--|----|
| United States (FCC) .....  | 44 |
| OEM labeling requirements .....                                  | 44 |
| FCC notices .....  | 44 |
| FCC-approved antennas (2.4 GHz) .....                            | 45 |
| RF exposure .....  | 53 |
| XBee 3 USB Adapter .....   | 53 |
| FCC publication 996369 related information .....                 | 53 |
| Over-voltage detection .....                                     | 54 |
| Europe (CE/UKCA) .....   | 54 |
| Maximum power and frequency specifications .....                 | 54 |
| CE and UKCA OEM labeling requirements .....                      | 55 |
| Declarations of conformity .....                                 | 56 |
| Antennas .....   | 56 |
| ISED (Innovation, Science and Economic Development Canada) ..... | 57 |
| Labeling requirements .....                                      | 57 |
| For XBee 3 .....   | 57 |
| RF Exposure .....  | 57 |
| Australia (RCM)/New Zealand .....                                | 58 |
| Brazil ANATEL .....  | 58 |
| Modelo: XBee 3 .....   | 58 |
| Japan (TELEC) .....  | 59 |
| Mexico (IFETEL) .....  | 60 |
| OEM labeling requirements .....                                  | 60 |
| South Korea .....  | 60 |

## XBIB-C development boards

|  |    |
|--|----|
| XBIB-C Micro Mount reference .....         | 63 |
| XBIB-C SMT reference .....                 | 65 |
| XBIB-CU TH reference .....                 | 67 |
| XBIB-C-GPS reference .....                 | 69 |
| Interface with the XBIB-C-GPS module ..... | 71 |
| I2C communication .....                    | 72 |
| UART communication .....                   | 72 |
| Attach the XBee 3 RF Module .....          | 72 |
| Micro .....                                | 72 |

|                     |    |
|---------------------|----|
| Surface-mount ..... | 73 |
| Through-hole .....  | 73 |

## Manufacturing information

|                                       |    |
|---------------------------------------|----|
| Recommended solder reflow cycle ..... | 75 |
| Handling and storage .....            | 75 |
| Recommended footprint .....           | 75 |
| Flux and cleaning .....               | 77 |
| Reworking .....                       | 78 |

## Troubleshooting

|   |    |
|---|----|
| Brownout issue .....                      | 80 |
| Voltage brownout .....                    | 80 |
| Voltage ramp up discontinuities .....     | 80 |
| How to distinguish revision B parts ..... | 80 |

# Digi XBee® 3 RF Module Hardware Reference Manual

---

This manual provides information for the XBee 3 RF Module hardware. The XBee 3 RF Module can be any of the following form factors:

- Micro-mount
- Through-hole
- Surface-mount

For more information about the operation and programming functions of the device, see:

- [XBee 3 DigiMesh RF Module User Guide](#)
- [XBee 3 Zigbee RF Module User Guide](#)
- [XBee 3 802.15.4 RF Module User Guide](#)

|                           |   |
|---------------------------|---|
| Safety instructions ..... | 8 |
|---------------------------|---|

## Safety instructions

### XBee modules

- The XBee radio module cannot be guaranteed operation due to the radio link and so should not be used for interlocks in safety critical devices such as machines or automotive applications.
- The XBee radio module have not been approved for use in (this list is not exhaustive):
  - medical devices
  - nuclear applications
  - explosive or flammable atmospheres
- There are no user serviceable components inside the XBee radio module. Do not remove the shield or modify the XBee in any way. Modifications may exclude the module from any warranty and can cause the XBee radio to operate outside of regulatory compliance for a given country, leading to the possible illegal operation of the radio.
- Use industry standard ESD protection when handling the XBee module.
- Take care while handling to avoid electrical damage to the PCB and components.
- Do not expose XBee radio modules to water or moisture.
- Use this product with the antennas specified in the XBee module user guides.
- The end user must be told how to remove power from the XBee radio module or to locate the antennas 20 cm from humans or animals.



## General XBee 3 specifications

---

The following tables provide general specifications for the hardware.

|   |    |
|---|----|
| General specifications .....              | 10 |
| Electrical characteristics .....          | 10 |
| Regulatory conformity summary .....       | 11 |
| Serial communication specifications ..... | 12 |
| GPIO specifications .....                 | 12 |
| Electro Static Discharge (ESD) .....      | 13 |

## General specifications

The following table describes the general specifications for the devices.

| Specification                     | XBee 3/XBee 3-PRO micro-mount  | XBee 3/XBee 3-PRO surface-mount                                 | XBee 3/XBee 3-PRO through-hole                       |
|-----------------------------------|--|---|--|
| Operating frequency band          | ISM 2.4 – 2.4835 GHz   |   |  |
| Form factor                       | Micro-mount  | Surface-mount   | Through-hole   |
| Dimensions                        | Micro-mount: 1.36 cm x 1.93 cm x 0.241 cm (0.534 in x 0.760 in x 0.095 in) | Surface-mount: 2.199 x 3.4 x 0.368 cm (0.866 x 1.33 x 0.145 in) | Through-hole: 2.438 x 2.761 cm (0.960 x 1.087 in)    |
| Weight                            | 1.2 g  | 2.9 g   | 3.1 g  |
| Operating temperature             | -40 to 85 °C (industrial)  |   |  |
| Antenna options                   | RF pad, chip antenna, or U.FL connector                                    | RF pad, embedded antenna, or U.FL connector                     | RPSMA connector, embedded antenna, or U.FL connector |
| Analog-to-digital converter (ADC) | 4 10-bit analog inputs   | 4 10-bit analog inputs  | 4 10-bit analog inputs                               |

## Electrical characteristics

The following table lists the electrical characteristics for the XBee 3 RF Module.

| Symbol          | Parameter                   | Condition                                   | Min       | Typical | Max       | Units |
|-----------------|-----------------------------|---|-----------|---------|-----------|-------|
| V <sub>I</sub>  | Input pins                  |   | -0.3      |         | VCC +0.3  | V     |
| V <sub>IL</sub> | Input low voltage           |   |           |         | 0.3 * VCC | V     |
| V <sub>IH</sub> | Input high voltage          |   | 0.7 * VCC |         |           | V     |
| V <sub>OL</sub> | Output low voltage          | Sinking 3 mA VCC = 3.3 V                    |           |         | 0.2 * VCC | V     |
| V <sub>OH</sub> | Output high voltage         | Sourcing 3 mA VCC = 3.3 V                   | 0.8 * VCC |         |           | V     |
| I <sub>IN</sub> | Input leakage current       | High Z state I/O connected to Ground or VCC |           | 0.1     | 100       | nA    |
| RPU             | Internal pull-up resistor   | Enabled                                     |           | 40      | -         | kΩ    |
| RPD             | Internal pull-down resistor | Enabled                                     |           | 40      | -         | kΩ    |

## Regulatory conformity summary

This table describes the agency approvals for the devices.

| Approval   | XBee 3                                  | XBee 3-PRO                              |
|--|---|---|
| United States (FCC Part 15.247)                            | FCC ID: MCQ-XBEE3                       | FCC ID: MCQ-XBEE3                       |
| Innovation, Science and Economic Development Canada (ISED) | IC: 1846A-XBEE3                         | IC: 1846A-XBEE3                         |
| FCC/IC Test Transmit Power Output range                    | -6.8 to +8 dBm                          | -6.8 to +19.9 dBm                       |
| <b>Bluetooth</b> ® (XBee 3 Zigbee only)                    | Declaration ID: D042514<br>QDID: 121268 | Declaration ID: D042514<br>QDID: 121268 |
| Australia  | RCM                                     | RCM                                     |
| Brazil   | ANATEL 06329-18-01209                   | ANATEL 06329-18-01209                   |
| Europe (CE)  | Yes                                     | No                                      |
| Japan (TELEC)  | R210-119309                             | No                                      |
| Mexico (IFETEL)  | IFT #: RCPDIXB19-1820                   | IFT #: RCPDIXB19-1820                   |
| RoHS   | Compliant                               |   |
| South Korea (KCC)  | R-C-DIG-XBEE3                           | No                                      |

## Serial communication specifications

The XBee 3 RF Module supports Universal Asynchronous Receiver / Transmitter (UART) and Serial Peripheral Interface (SPI) serial connections.

### UART pin assignments

| UART pins                               | Device pin number  |                      |                     |
|---|--------------------|----------------------|---------------------|
|   | XBee 3 micro-mount | XBee 3 surface-mount | XBee 3 through-hole |
| DOUT/DIO13                              | 3                  | 3                    | 2                   |
| DIN / $\overline{\text{CONFIG}}$ /DIO14 | 4                  | 4                    | 3                   |
| $\overline{\text{CTS}}$ / DIO7          | 24                 | 25                   | 12                  |
| $\overline{\text{RTS}}$ / DIO6          | 27                 | 29                   | 16                  |

### SPI pin assignments

| SPI pins  | Device pin number  |                      |                     |
|-----------|--------------------|----------------------|---------------------|
|           | XBee 3 micro-mount | XBee 3 surface-mount | XBee 3 through-hole |
| SPI_CLK   | 13                 | 14                   | 18                  |
| SPI_SSEL  | 14                 | 15                   | 17                  |
| SPI_MOSI  | 15                 | 16                   | 11                  |
| SPI_MISO  | 16                 | 17                   | 4                   |
| SPI_ATTEN | 11                 | 12                   | 19                  |

## GPIO specifications

XBee 3 RF Modules have 15 General Purpose Input / Output (GPIO) ports available. The exact list depends on the device configuration as some GPIO pads are used for purposes such as serial communication.

| GPIO electrical specification | Value                   |
|-------------------------------|-------------------------|
| Voltage - supply              | 2.1 - 3.6 V             |
| Low switching threshold       | 0.3 x VCC               |
| High switching threshold      | 0.7 x VCC               |
| Input pull-up resistor value  | 40 k $\Omega$ (typical) |

| GPIO electrical specification        | Value                   |
|--------------------------------------|-------------------------|
| Input pull-down resistor value       | 40 k $\Omega$ (typical) |
| Output voltage for logic 0           | 0.2 x VCC (maximum)     |
| Output voltage for logic 1           | 0.8 x VCC (minimum)     |
| Output source/sink current           | 50 mA (maximum)         |
| Total output current (for GPIO pads) | 200 mA (maximum)        |

## Electro Static Discharge (ESD)

XBee 3 RF Module pins are tolerant to human-body model  $\pm 1.5$  kV.

---

**Note** Take care to limit all electrostatic discharges to the device.

---

## IEEE 802.15.4-specific specifications

---

The following tables provide specifications specific to the XBee 3 RF Module when using the IEEE 802.15.4 physical layer, for example: XBee 802.15.4, Zigbee, DigiMesh, and so on.

|  |    |
|--|----|
| Performance specifications .....             | 15 |
| Power requirements .....                     | 15 |
| Networking and security specifications ..... | 15 |
| Communication interface specifications ..... | 16 |

## Performance specifications

The following table describes the performance specifications for the devices.

| Specification                      | XBee 3                 | XBee 3-PRO          |
|------------------------------------|------------------------|---------------------|
| Indoor/urban range                 | Up to 60 m (200 ft)    | Up to 90 m (300 ft) |
| Outdoor RF line-of-sight range     | Up to 1200 m (4000 ft) | Up to 3200 m (2 mi) |
| RF Transmit power output (maximum) | 6.3 mW (+8 dBm)        | 79 mW (+19 dBm)     |
| BLE power output                   | 6.3 mW (+8 dBm)        | 6.3 mW (+8 dBm)     |
| RF data rate                       | 250,000 b/s            |                     |
| Receiver sensitivity               | -103 dBm               |                     |

**Note** Range figure estimates are based on free-air terrain with limited sources of interference. Actual range will vary based on transmitting power, orientation of transmitter and receiver, height of transmitting antenna, height of receiving antenna, weather conditions, interference sources in the area, and terrain between receiver and transmitter, including indoor and outdoor structures such as walls, trees, buildings, hills, and mountains.

## Power requirements

The following table describes the power requirements for the XBee 3 RF Module.

| Specification                         | XBee 3                 | XBee 3-PRO               |
|---------------------------------------|------------------------|--------------------------|
| Adjustable power                      | Yes                    |                          |
| Supply voltage                        | 2.1 - 3.6 V            |                          |
| Operating current (transmit, typical) | 40 mA @ +3.3 V, +8 dBm | 135 mA @ +3.3 V, +19 dBm |
| Operating current (receive, typical)  | 17 mA                  |                          |
| Power-down current, typical           | 2 $\mu$ A @ 25° C      |                          |

## Networking and security specifications

The following table describes the networking and security specifications for the devices.

| Specification                | XBee 3/XBee 3-PRO   |
|------------------------------|---|
| Supported network topologies | Point-to-point, point-to-multipoint, peer-to-peer, and DigiMesh |
| Number of channels           | 16 Direct sequence channels                                     |
| Interface immunity           | Direct Sequence Spread Spectrum (DSSS)                          |
| Channels                     | 11 to 26  |
| Addressing options           | PAN ID and addresses, cluster IDs and endpoints (optional)      |

## Communication interface specifications

The following table provides the device's communication interface specifications.

| Interface options |  |
|-------------------|--|
| UART              | Standard UART baud rates up to 921600 b/s<br>Non-standard UART baud rates up to 967680 b/s |
| SPI               | 5 Mb/s (burst)   |



## Mechanical drawings

---

The following mechanical drawings of the XBee 3 RF Modules show all dimensions in inches.

|                                     |    |
|-------------------------------------|----|
| XBee 3 surface-mount antennas ..... | 18 |
| XBee 3 micro antennas .....         | 20 |
| XBee 3 through-hole antennas .....  | 22 |

## XBee 3 surface-mount antennas

The following mechanical drawings are for the XBee 3 surface-mount antennas.

### XBee 3 surface-mount - U.FL/RF pad antenna

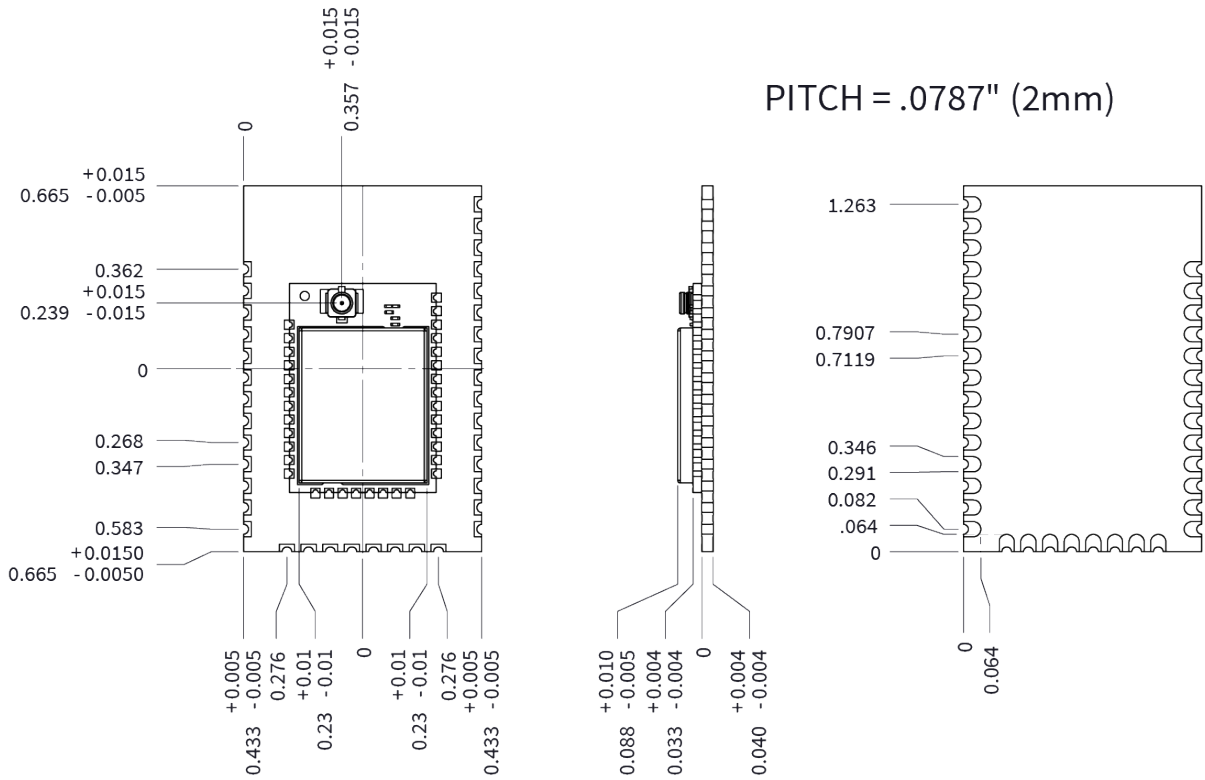



## XBee 3 micro antennas

The following mechanical drawings are for the XBee 3 micro antennas.

### XBee 3 micro (U.FL/RF Pad)

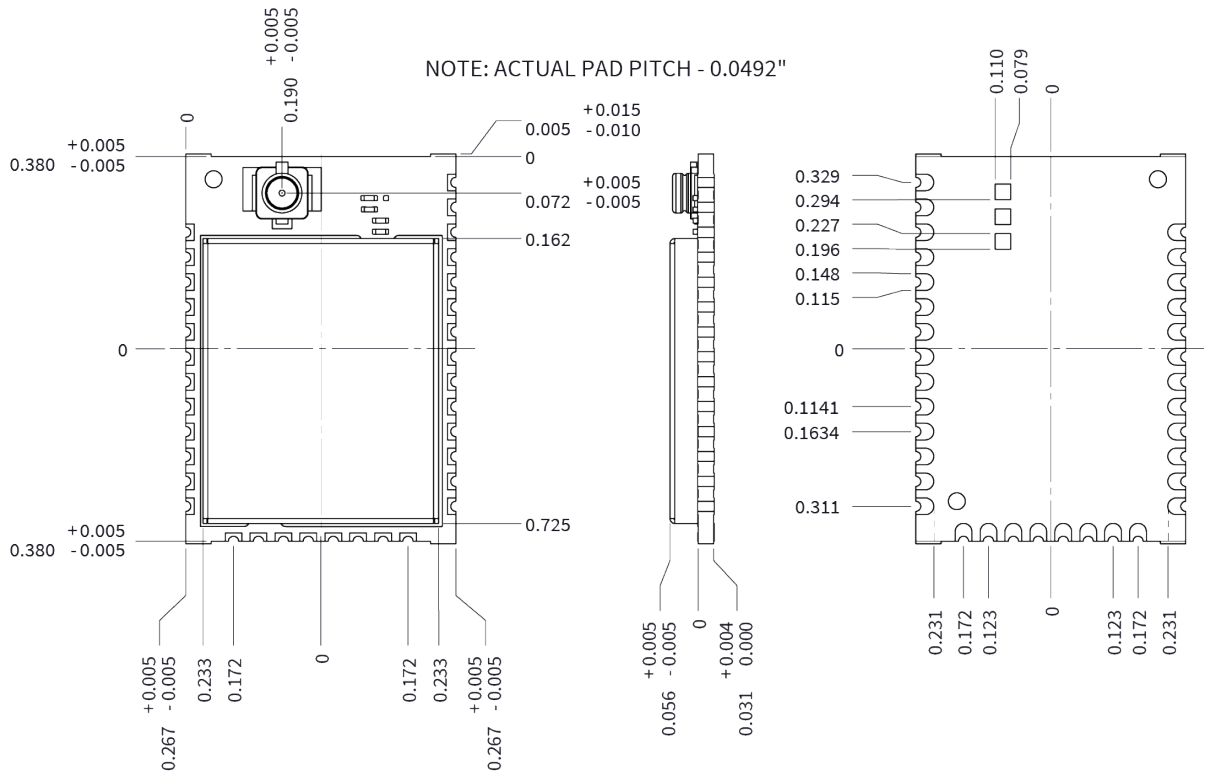

### XBee 3 micro (chip antenna)

NOTE: ACTUAL PAD PITCH - 0.0492"

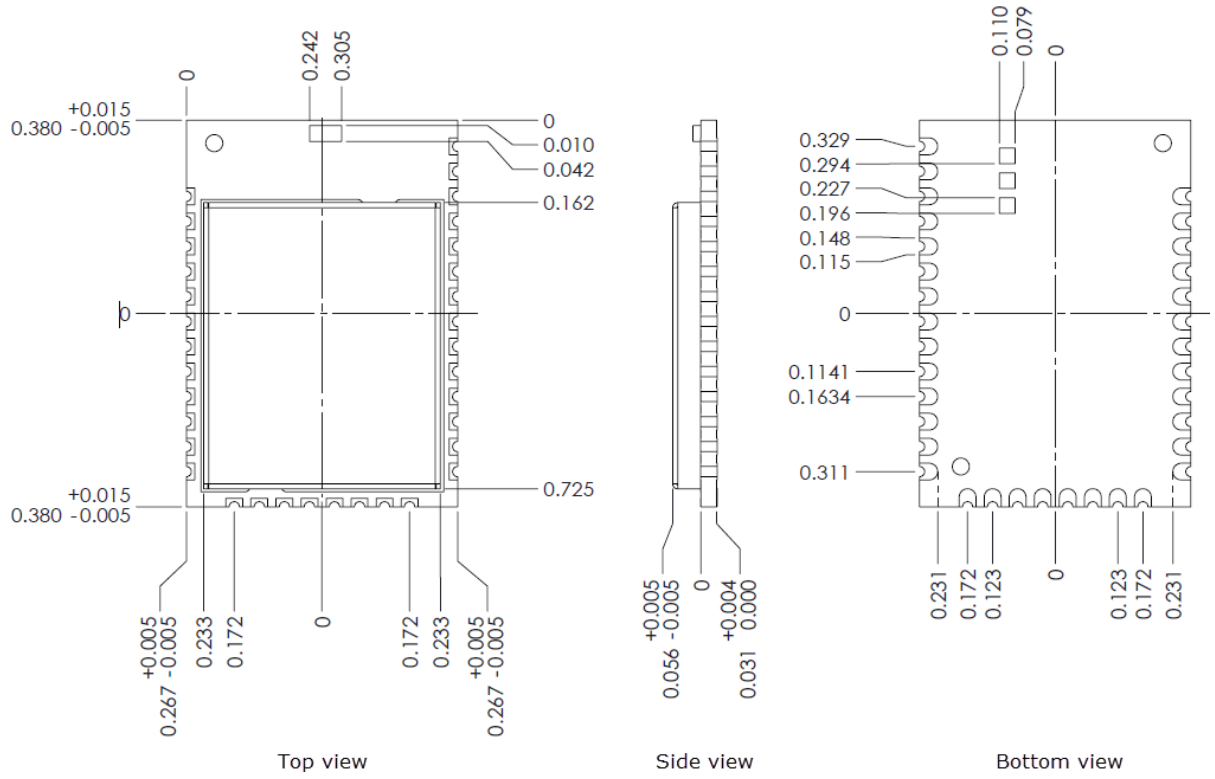

## XBee 3 through-hole antennas

The following mechanical drawings are for the XBee 3 through-hole antennas.

### XBee 3 through-hole - PCB antenna

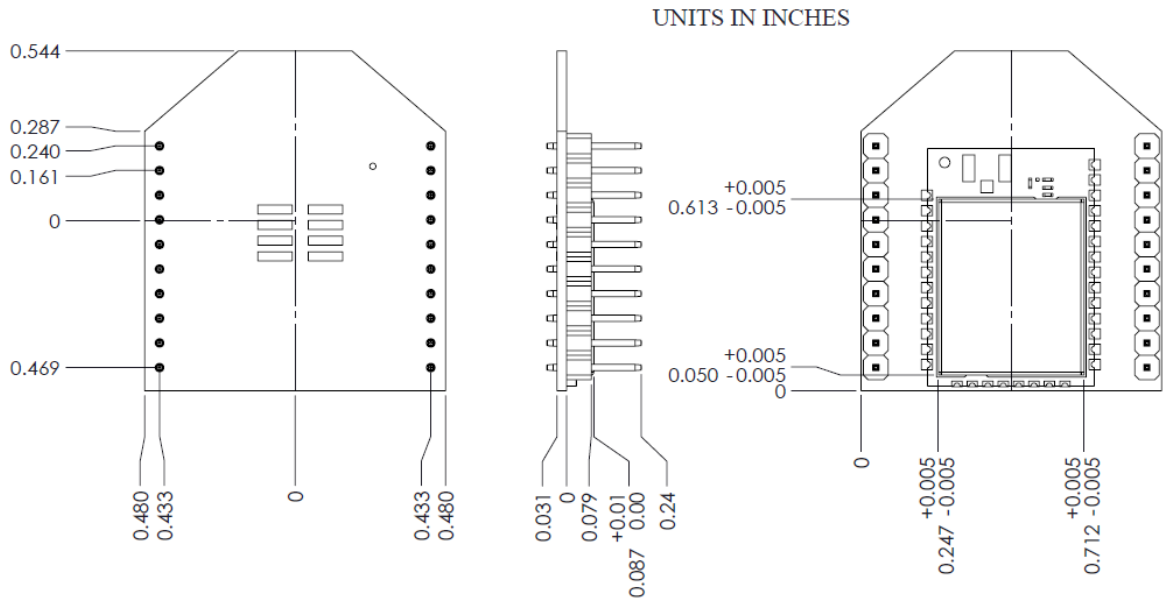

### XBee 3 through-hole - U.FL antenna

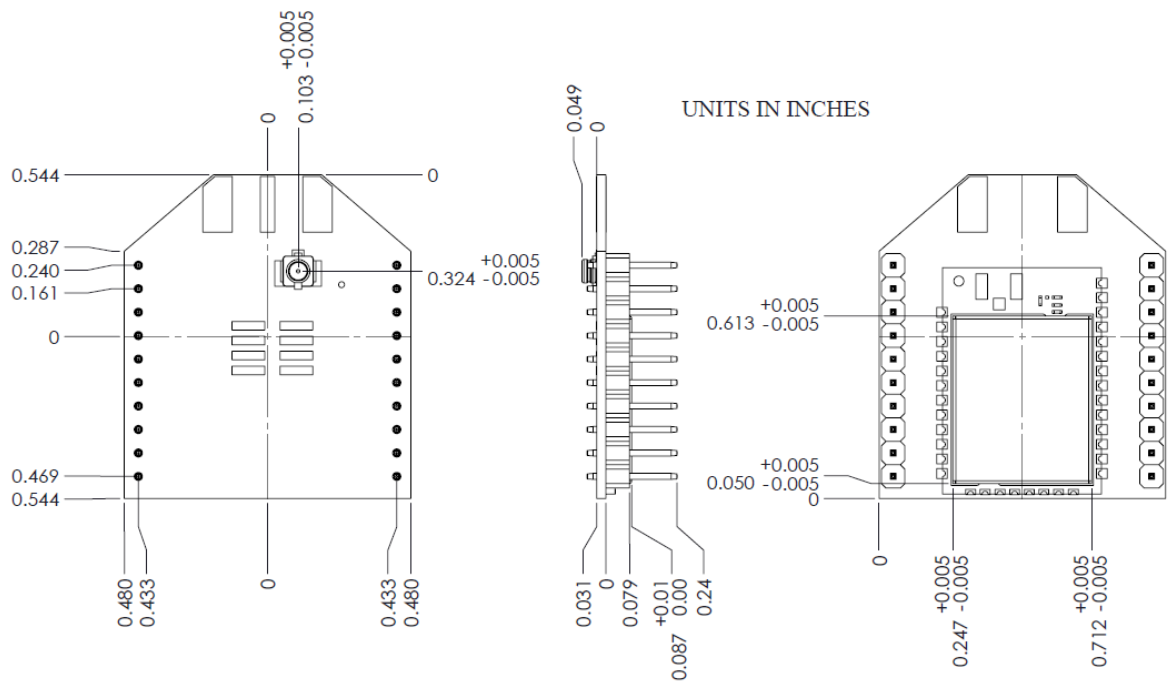

### XBee 3 through-hole - RPSMA antenna

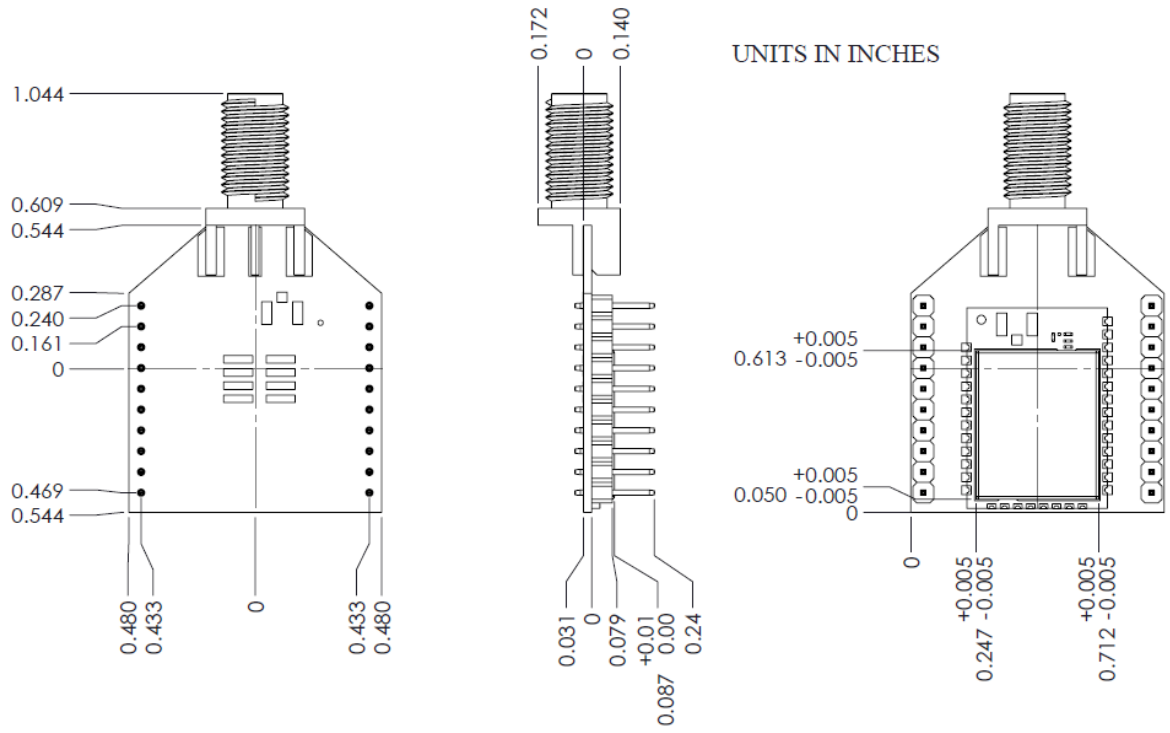

## Pin signals

---

|   |    |
|---|----|
| Pin signals for the XBee 3 surface-mount module ..... | 25 |
| Pin signals for the XBee 3 micro module .....         | 28 |
| Pin signals for the XBee 3 through-hole module .....  | 31 |
| Recommended pin connections .....                     | 32 |



## Pin signals for the XBee 3 surface-mount module

The following drawing shows the surface-mount (SMT) pin locations.

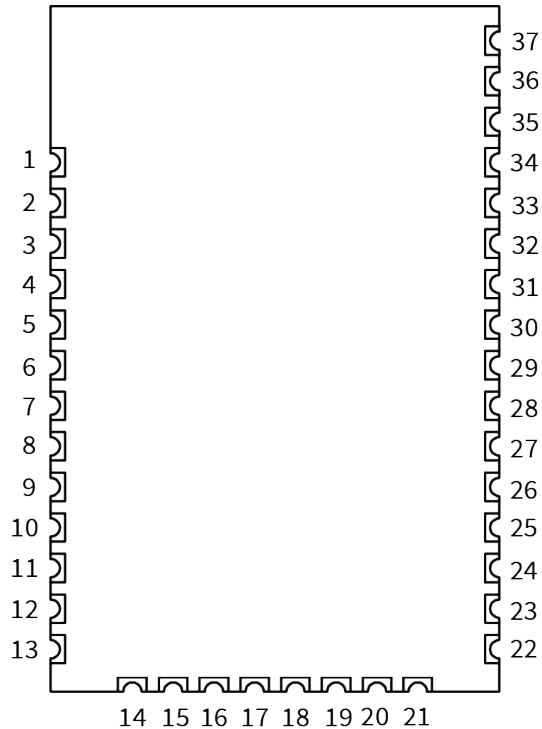

The following table shows the pin signals and their descriptions for the surface-mount device.

| Pin# | Name                                    | Direction | Default state | Description                         |
|------|---|-----------|---------------|-------------------------------------|
| 1    | GND                                     | -         | -             | Ground.                             |
| 2    | VCC                                     | -         | -             | Power supply.                       |
| 3    | DOUT /DIO13                             | Both      | Output        | UART data out /GPIO.                |
| 4    | DIN / $\overline{\text{CONFIG}}$ /DIO14 | Both      | Input         | UART data in /GPIO.                 |
| 5    | DIO12                                   | Both      |               | GPIO.                               |
| 6    | $\overline{\text{RESET}}$               | Input     |               | Device reset.                       |
| 7    | RSSI PWM/DIO10                          | Both      | Output        | RX signal strength Indicator /GPIO. |
| 8    | PWM1/DIO11/I2C SDA                      | Both      | Disabled      | Pulse width modulator/GPIO/I2C SDA. |
| 9    | [reserved]                              | -         | Disabled      | Do not connect.                     |

| Pin# | Name                              | Direction | Default state | Description  |
|------|-----------------------------------|-----------|---------------|--|
| 10   | DTR/SLEEP_RQ /DIO8                | Both      | Input         | Pin sleep control Line/GPIO.                                     |
| 11   | GND                               | -         | -             | Ground.  |
| 12   | SPI_ATT $\bar{N}$ /BOOTMODE/DIO19 | Output    | Output        | Serial peripheral interface attention . Do not tie low on reset. |
| 13   | GND                               | -         | -             | Ground.  |
| 14   | SPI_CLK /DIO18                    | Input     | Input         | Serial peripheral interface clock/GPIO.                          |
| 15   | SPI_SSEL/DIO17                    | Input     | Input         | Serial peripheral interface not select/GPIO.                     |
| 16   | SPI_MOSI/DIO16                    | Input     | Input         | Serial peripheral interface data in/GPIO.                        |
| 17   | SPI_MISO/DIO15                    | Output    | Output        | Serial peripheral interface data out/GPIO.                       |
| 18   | [reserved]                        | -         | Disabled      | Do not connect.  |
| 19   | [reserved]                        | -         | Disabled      | Do not connect.  |
| 20   | [reserved]                        | -         | Disabled      | Do not connect.  |
| 21   | [reserved]                        | -         | Disabled      | Do not connect.  |
| 22   | GND                               | -         | -             | Ground.  |
| 23   | [reserved]                        | -         | Disabled      | Do not connect.  |
| 24   | DIO4                              | Both      | Disabled      | GPIO.  |
| 25   | CTS/DIO7                          | Both      | Output        | Clear to send flow control/GPIO.                                 |
| 26   | ON/SLEEP/DIO9                     | Both      | Output        | Device status indicator/GPIO                                     |
| 27   | [reserved]                        | -         | Disabled      | Do not connect or connect to Ground.                             |
| 28   | ASSOCIATE/DIO5                    | Both      | Output        | Associate Indicator/GPIO.  |

| Pin#   | Name             | Direction | Default state | Description                                 |
|--|------------------|-----------|---------------|---|
| 29   | RTS/DIO6         | Both      | Input         | Request to send flow control /GPIO.         |
| 30   | AD3/DIO3         | Both      | Disabled      | Analog input/GPIO.                          |
| 31   | AD2/DIO2         | Both      | Disabled      | Analog input/GPIO                           |
| 32   | AD1/DIO1/I2C SCL | Both      | Disabled      | Analog input/GPIO/I2C SCL.                  |
| 33   | AD0 /DIO0        | Both      | Input         | Analog input / GPIO / Commissioning button. |
| 34   | [reserved]       | -         | Disabled      | Do not connect.                             |
| 35   | GND              | -         | -             | Ground.                                     |
| 36   | RF               | Both      | -             | RF I/O for RF pad variant.                  |
| 37   | [reserved]       | -         | Disabled      | Do not connect.                             |
| <p>Signal direction is specified with respect to the device. This is a complete list of functionalities. See the applicable software manual for available functionalities.</p>                       |                  |           |               |   |
| <p><b>Note</b> There are a possible three RF test points located on the bottom of the device. Do not connect these test points. For more information, see <a href="#">Recommended footprint</a>.</p> |                  |           |               |   |
| <p>See <a href="#">Design notes</a> for details on pin connections.</p>  |                  |           |               |   |

## Pin signals for the XBee 3 micro module

The following drawing shows the micro pin locations.

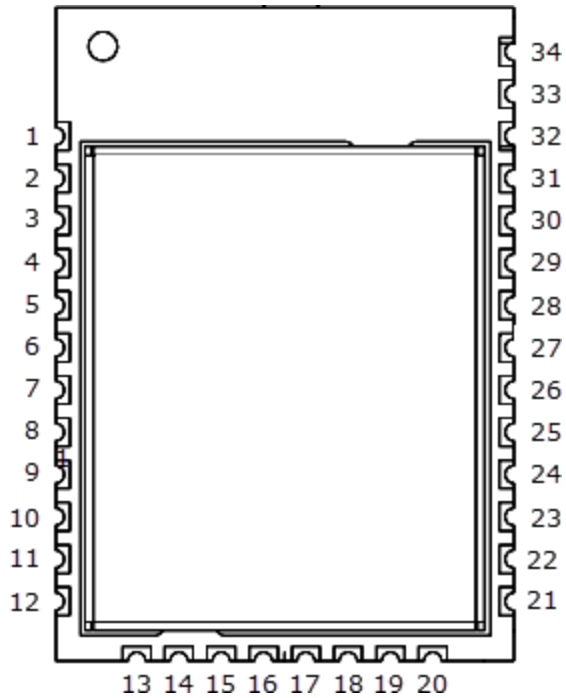

The following table shows the pin signals and their descriptions for the XBee 3 Micro device.

| Pin# | Name                                    | Direction | Default state | Description                         |
|------|---|-----------|---------------|-------------------------------------|
| 1    | GND                                     | -         | -             | Ground.                             |
| 2    | VCC                                     | -         | -             | Power supply.                       |
| 3    | DOUT /DIO13                             | Both      | Output        | UART data out /GPIO.                |
| 4    | DIN / $\overline{\text{CONFIG}}$ /DIO14 | Both      | Input         | UART data in /GPIO.                 |
| 5    | DIO12                                   | Both      |               | GPIO.                               |
| 6    | $\overline{\text{RESET}}$               | Input     |               | Device reset.                       |
| 7    | RSSI PWM/DIO10                          | Both      | Output        | RX signal strength Indicator /GPIO. |
| 8    | PWM1/DIO11/I2C SDA                      | Both      | Disabled      | Pulse width modulator/GPIO/I2C SDA. |
| 9    | $\overline{\text{DTR}}$ /SLEEP_RQ /DIO8 | Both      | Input         | Pin sleep control Line/GPIO.        |

| Pin# | Name  | Direction | Default state | Description   |
|------|---|-----------|---------------|---|
| 10   | GND   | -         | -             | Ground.   |
| 11   | SPI_ATTN/ $\overline{\text{BOOTMODE}}$ /DIO19 | Output    | Output        | Serial peripheral interface attention<br>Do not tie low on reset. |
| 12   | GND   | -         | -             | Ground.   |
| 13   | SPI_CLK /DIO18                                | Input     | Input         | Serial peripheral interface clock/GPIO.                           |
| 14   | $\overline{\text{SPI\_SSEL}}$ /DIO17          | Input     | Input         | Serial peripheral interface not select/GPIO.                      |
| 15   | SPI_MOSI/DIO16                                | Input     | Input         | Serial peripheral interface data in/GPIO.                         |
| 16   | SPI_MISO/DIO15                                | Output    | Output        | Serial peripheral interface data out/GPIO.                        |
| 17   | [reserved]                                    | -         | Disabled      | Do not connect.   |
| 18   | [reserved]                                    | -         | Disabled      | Do not connect.   |
| 19   | [reserved]                                    | -         | Disabled      | Do not connect.   |
| 20   | [reserved]                                    | -         | Disabled      | Do not connect.   |
| 21   | GND   | -         | -             | Ground.   |
| 22   | [reserved]                                    | -         | Disabled      | Do not connect.   |
| 23   | DIO4  | Both      | Disabled      | GPIO.   |
| 24   | $\overline{\text{CTS}}$ /DIO7                 | Both      | Output        | Clear to send flow control/GPIO.                                  |
| 25   | ON/ $\overline{\text{SLEEP}}$ /DIO9           | Both      | Output        | Device status indicator/GPIO.                                     |
| 26   | ASSOCIATE/DIO5                                | Both      | Output        | Associate Indicator/GPIO.   |
| 27   | $\overline{\text{RTS}}$ /DIO6                 | Both      | Input         | Request to send flow control /GPIO.                               |
| 28   | AD3/DIO3                                      | Both      | Disabled      | Analog input/GPIO.  |

| Pin#   | Name             | Direction | Default state | Description                                 |
|--|------------------|-----------|---------------|---|
| 29   | AD2/DIO2         | Both      | Disabled      | Analog input/GPIO.                          |
| 30   | AD1/DIO1/I2C SCL | Both      | Disabled      | Analog input/GPIO/I2C SCL.                  |
| 31   | AD0 /DIO0        | Both      | Input         | Analog input / GPIO / Commissioning button. |
| 32   | GND              | -         | -             | Ground.                                     |
| 33   | RF               | Both      | -             | RF I/O for RF pad variant.                  |
| 34   | GND              | -         | -             | Ground.                                     |
| <p>Signal direction is specified with respect to the device. This is a complete list of functionalities. See the applicable software manual for available functionalities.</p> <hr/> <p><b>Note</b> There are three RF test points located on the bottom of the device. Do not connect these test points. For more information, see <a href="#">Recommended footprint</a>.</p> <hr/> <p>See <a href="#">Design notes</a> for details on pin connections.</p> |                  |           |               |   |

## Pin signals for the XBee 3 through-hole module

The following drawing shows the through-hole pin locations.

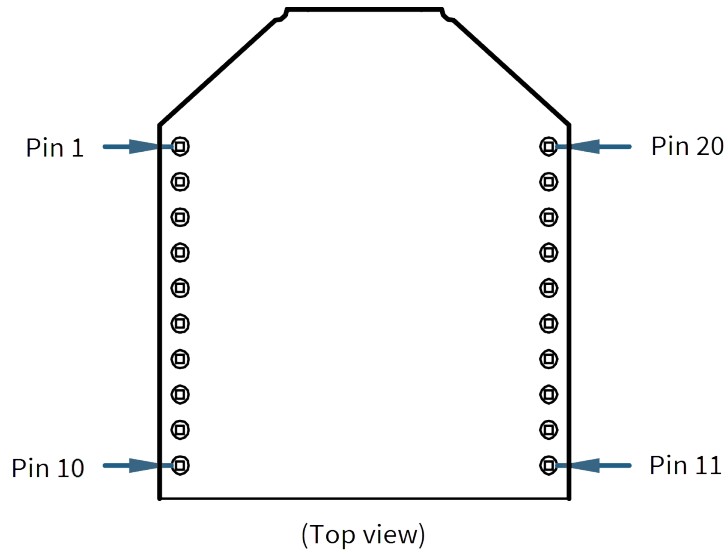

The following table shows the pin signals and their descriptions for the XBee 3 through-hole device.

| Pin# | Name               | Direction | Default state | Description                               |
|------|--------------------|-----------|---------------|---|
| 1    | VCC                | -         | -             | Power supply.                             |
| 2    | DOUT/DIO13         | Both      | Output        | UART data out/GPIO.                       |
| 3    | DIN/CONFIG/DIO14   | Both      | Input         | UART data in/GPIO.                        |
| 4    | DIO12/SPI_MISO     | Both      | -             | GPIO/SPI data out.                        |
| 5    | RESET              | Input     | -             | Device reset.                             |
| 6    | RSSI PWM/DIO10     | Both      | Output        | RX signal Indicator strength/GPIO.        |
| 7    | PWM1/DIO11/I2C SDA | Both      | Disabled      | Pulse width modulator/GPIO/I2C SDA.       |
| 8    | [reserved]         | -         | Disabled      | Do not connect.                           |
| 9    | DTR/SLEEP_RQ/DIO8  | Both      | Input         | Pin sleep control Line/GPIO.              |
| 10   | GND                | -         | -             | Ground.                                   |
| 11   | DIO4/SPI_MOSI      | Both      | Disabled      | GPIO/Serial peripheral interface data in. |

| Pin#   | Name   | Direction | Default state | Description                              |
|--|--|-----------|---------------|--|
| 12   | $\overline{\text{CTS}}$ /DIO7                    | Both      | Output        | Clear to send flow control/GPIO.         |
| 13   | ON/ $\overline{\text{SLEEP}}$ /DIO9              | Both      | Output        | Device status indicator/GPIO.            |
| 14   | [reserved]                                       | -         | Disabled      | Do not connect or connect to Ground.     |
| 15   | ASSOCIATE/DIO5                                   | Both      | Output        | Associate Indicator/GPIO.                |
| 16   | $\overline{\text{RTS}}$ /DIO6                    | Both      | Input         | Request to send flow control/GPIO.       |
| 17   | AD3/DIO3/ $\overline{\text{SPI\_SSEL}}$          | Both      | Disabled      | Analog input/GPIO/SPI not select.        |
| 18   | AD2/DIO2/ $\overline{\text{SPI\_CLK}}$           | Both      | Disabled      | Analog input/GPIO/SPI clock.             |
| 19   | AD1/DIO1/ $\overline{\text{SPI\_ATTN}}$ /I2C SCL | Both      | Disabled      | Analog input/GPIO/SPI attention/I2C SCL. |
| 20   | AD0 /DIO0  | Both      | Input         | Analog input/GPIO/Commissioning button.  |
| Signal direction is specified with respect to the device. This is a complete list of functionalities. See the applicable software manual for available functionalities. See <a href="#">Design notes</a> for details on pin connections. |  |           |               |  |
| * The I2C functionality will be software enabled in a future release.  |  |           |               |  |

## Recommended pin connections

The only required pin connections for two-way communication are VCC, GND, DOUT and  $\overline{\text{DIN}}$ . To support serial firmware updates and recovery, you must connect VCC, GND, DOUT,  $\overline{\text{DIN}}$ , RTS, and DTR. For applications that need to ensure the lowest sleep current, never leave unconnected inputs floating. Use internal or external pull-up or pull-down resistors, or set the unused I/O lines to outputs.

## Design notes

XBee 3 RF Modules do not require any external circuitry or specific connections for proper operation. However, there are some general design guidelines that we recommend to build and troubleshoot a robust design.



|   |    |
|---|----|
| Power supply design .....                                   | 34 |
| Board layout .....  | 34 |
| Antenna performance .....                                   | 34 |
| Design notes for PCB antenna and chip antenna devices ..... | 35 |
| Design notes for RF pad devices .....                       | 38 |
| Copper keepout for test points .....                        | 40 |

## Power supply design

A poor power supply can lead to poor device performance, especially if you do not keep the supply voltage within tolerance or if it is excessively noisy. To help reduce noise, place a 1.0  $\mu\text{F}$  and 8.2 pF capacitor as near as possible to the VCC connection on the XBee 3 (pad 2 for micro and surface-mount, and pin 1 for through-hole). Adding a 10  $\mu\text{F}$  decoupling capacitor is also recommended. If you are using a switching regulator for the power supply, switch the frequencies above 500 kHz. Limit the power supply ripple to a maximum 50 mV peak to peak. For best results, place the lower capacitance capacitors closest to the XBee 3 device.

---

**Note** XBee 3 parts with an early revision of the microcontroller unit (MCU) may experience an issue recovering from brownouts under rare conditions. See [Brownout issue](#) for details on how to avoid this issue.

---

## Board layout

We design XBee 3 modules to be self-sufficient and have minimal sensitivity to nearby processors, crystals or other printed circuit board (PCB) components. Keep power and ground traces thicker than signal traces and make sure that they are able to comfortably support the maximum current specifications. There are no other special PCB design considerations to integrate XBee 3 modules, with the exception of antennas.

## Antenna performance

Antenna location is important for optimal performance. The following suggestions help you achieve optimal antenna performance. Point the antenna up vertically (upright). Antennas radiate and receive the best signal perpendicular to the direction they point, so a vertical antenna's omnidirectional radiation pattern is strongest across the horizon.

Position the antennas away from metal objects whenever possible. Metal objects between the transmitter and receiver can block the radiation path or reduce the transmission distance. Objects that are often overlooked include:

- Metal poles
- Metal studs
- Structure beams
- Concrete, which is usually reinforced with metal rods

If you place the device inside a metal enclosure, use an external antenna. Common objects that have metal enclosures include:

- Vehicles
- Elevators
- Ventilation ducts
- Refrigerators
- Microwave ovens
- Batteries
- Tall electrolytic capacitors

Use the following additional guidelines for optimal antenna performance:

- Do not place XBee 3 devices with the chip antenna or the embedded antenna inside a metal enclosure.
- Do not place any ground planes or metal objects above or below the antenna.
- For the best results, mount the device at the edge of the host PCB. Ensure that the ground, power, and signal planes are vacant immediately below the antenna section.

## Design notes for PCB antenna and chip antenna devices

Position PCB/chip antenna devices so there are no ground planes or metal objects above or below the antenna. For best results, do not place the device in a metal enclosure, as this may greatly reduce the range. Place the device at the edge of the PCB on which it is mounted. Make sure the ground, power and signal planes are vacant immediately below the antenna section.

The following drawings illustrate important recommendations when you are designing with PCB/chip antenna devices. For optimal performance on the surface-mount device, do not mount the device on the RF pad footprint described in the next section, because the footprint requires a ground plane within the PCB antenna keepout area.

### Surface-mount embedded antenna keepout area

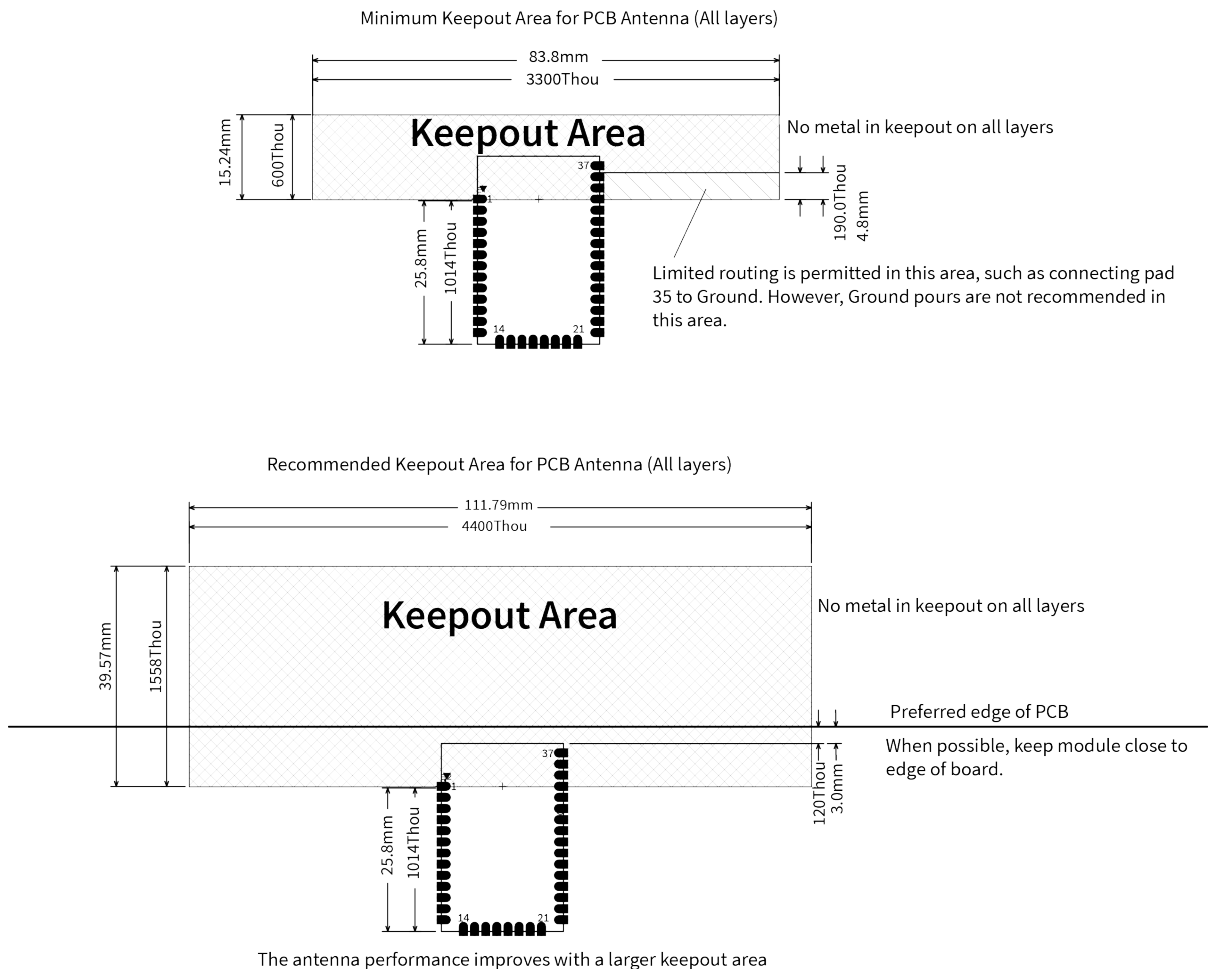

**Notes**

1. We recommend non-metal enclosures. For metal enclosures, use an external antenna.
2. Keep metal chassis or mounting structures in the keepout area at least 2.54 cm (1 in) from the antenna.
3. Maximize the distance between the antenna and metal objects that might be mounted in the keepout area.
4. These keepout area guidelines do not apply for chip antennas or external RF connectors.

**XBee 3 Micro chip antenna keepout area**

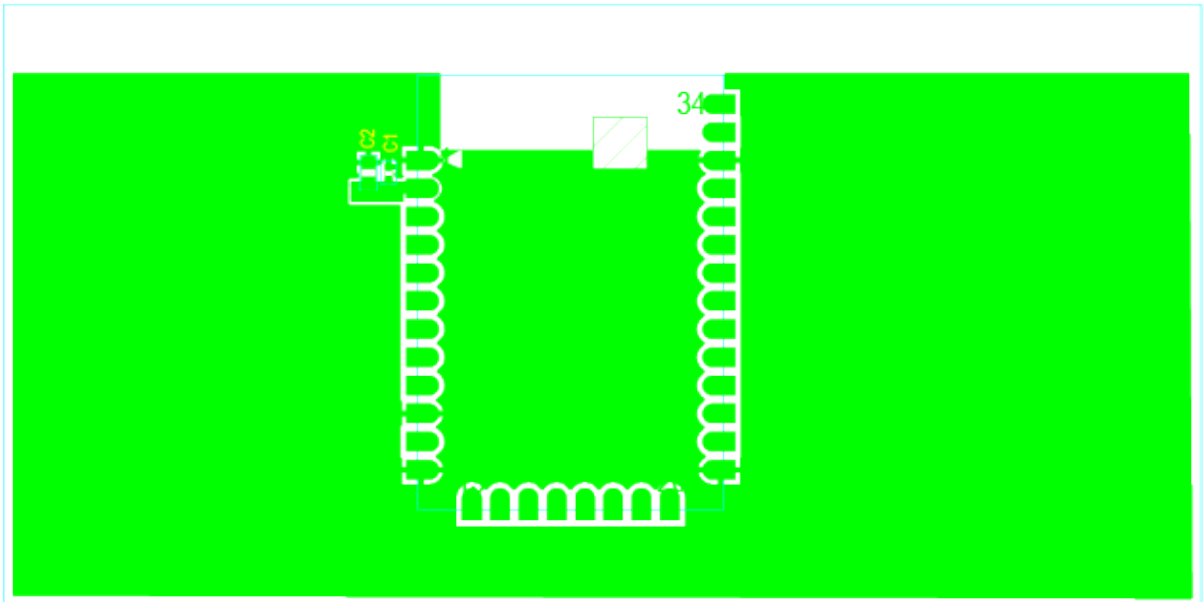
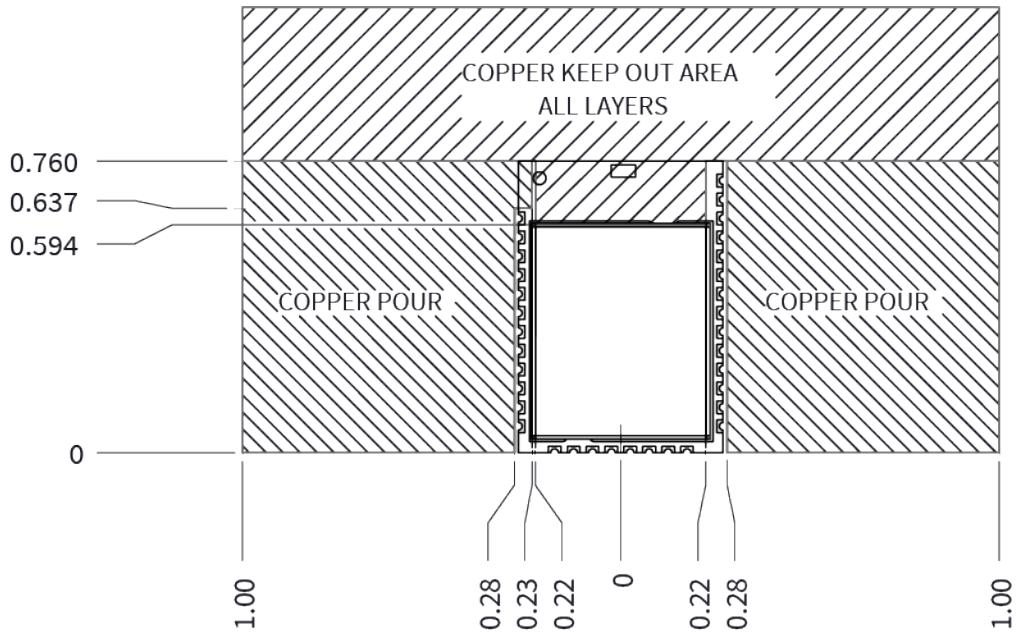

**Notes**

1. We recommend non-metal enclosures. For metal enclosures, use an external antenna.
2. Keep metal chassis or mounting structures in the keepout area at least 2.54 cm (1 in) from the antenna.
3. Maximize the distance between the antenna and metal objects that might be mounted in the keepout area.
4. Neither a copper pour nor a copper keepout is necessary under the shield area for proper antenna functionality. It is still necessary to follow the recommendations in [Recommended footprint](#) for the PCB layout.
5. These keepout area guidelines do not apply for surface-mount embedded antennas or external RF connectors.

**Through-hole embedded antenna keepout area**

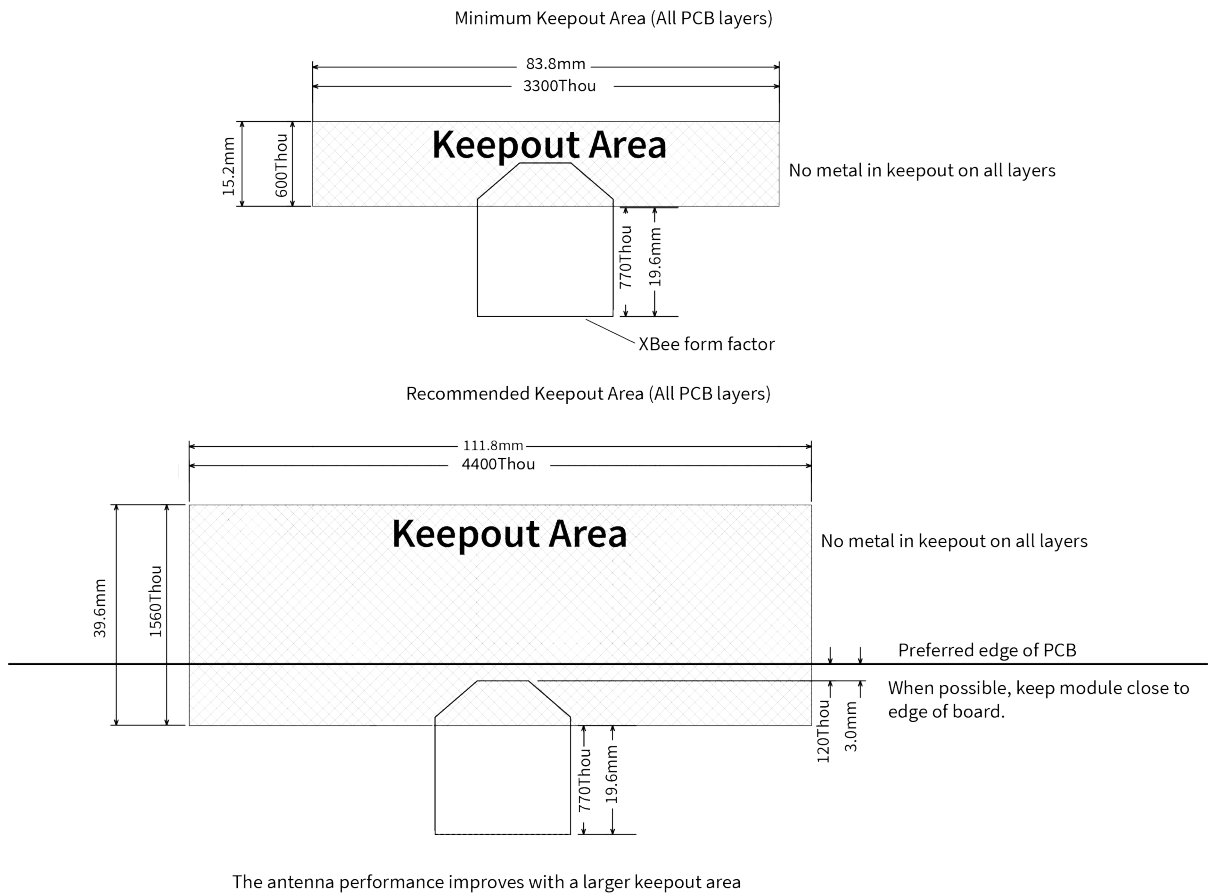

**Notes**

1. We recommend non-metal enclosures. For metal enclosures, use an external antenna.
2. Keep metal chassis or mounting structures in the keepout area at least 2.54 cm (1 in) from the antenna.

3. Maximize the distance between the antenna and metal objects that might be mounted in the keepout area.
4. These keepout area guidelines do not apply for external RF connectors.

## Design notes for RF pad devices

The RF pad is a soldered antenna connection. The RF signal travels from the RF pad connection (pad 33 on micro modules and pad 36 on surface-mount modules) on the device to the antenna through an RF trace transmission line on the PCB. Any additional components between the device and antenna violates modular certification. The controlled impedance for the RF trace is 50  $\Omega$ .

We recommend using a microstrip trace, although you can also use a coplanar waveguide if you need more isolation. A microstrip generally requires less area on the PCB than a coplanar waveguide. We do not recommend using a stripline because sending the signal to different PCB layers can introduce matching and performance problems.

Following good design practices is essential when implementing the RF trace on a PCB. Consider the following points:

- Minimize the length of the trace by placing the RPSMA jack close to the device.
- Connect all of the grounds on the jack and the device to the ground planes directly or through closely placed vias.
- Space any ground fill on the top layer at least twice the distance **d**, for Micro modules at least 0.028" and for surface mount modules at least 0.050".

Additional considerations:

- The top two layers of the PCB have a controlled thickness dielectric material in between.
- The second layer has a ground plane which runs underneath the entire RF pad area. This ground plane is a distance **d**, the thickness of the dielectric, below the top layer.
- The RF trace width determines the impedance of the transmission line with relation to the ground plane. Many online tools can estimate this value, although you should consult the PCB manufacturer for the exact width.

Implementing these design suggestions helps ensure that the RF pad device performs to its specifications.

The following figures show a layout example of a host PCB that connects an RF pad device to a right angle, through-hole RPSMA jack.

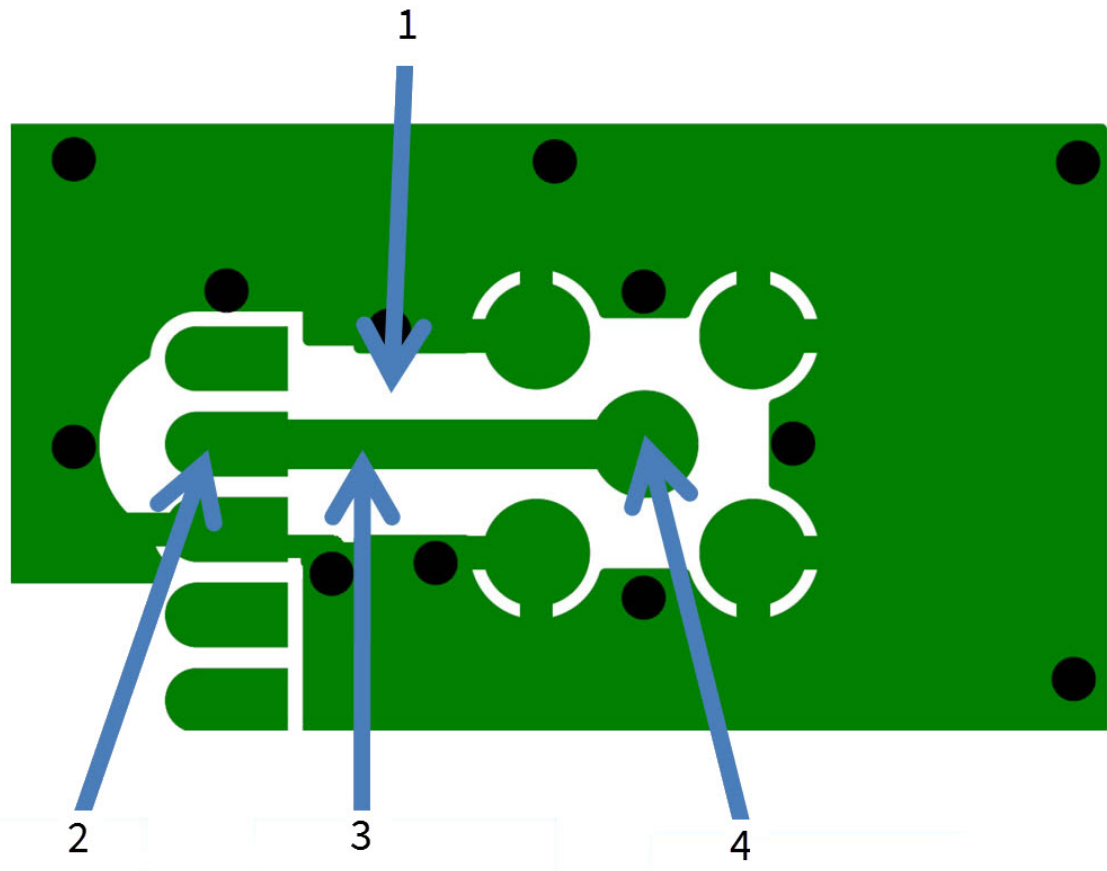

| Number | Description   |
|--------|---|
| 1      | Maintain a distance of at least 2 d between microstrip and ground fill. |
| 2      | RF pad pin.   |
| 3      | 50 Ω microstrip trace.  |
| 4      | RF connection of RPSMA jack.  |

This example is on a surface-mount device. The width in this example is approximately 0.045" for a 50 Ω trace, assuming  $d=0.025"$ , and that the dielectric has a relative permittivity of 4.4. This trace width is a good fit with the device footprint's 0.060" pad width.

**Note** We do not recommend using a trace wider than the pad width, and using a very narrow trace (under 0.010") can cause unwanted RF loss.

The following illustration shows PCB layer 2 of an example RF layout.

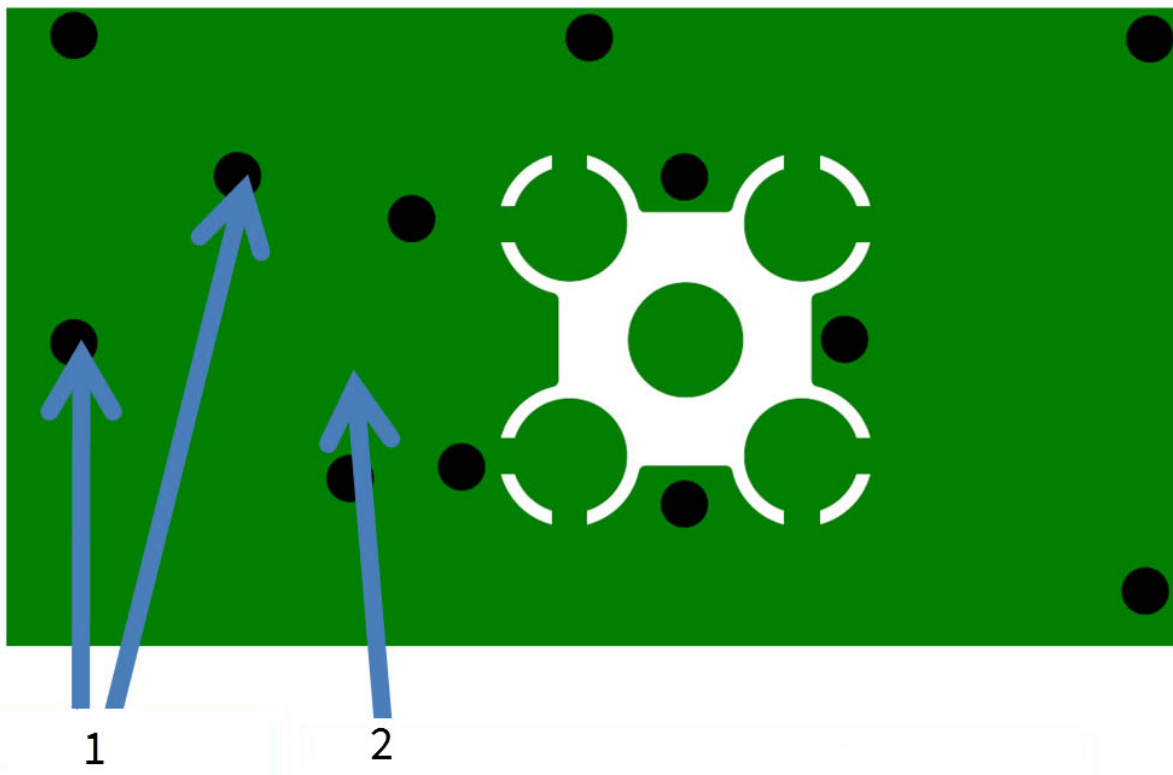

| Number | Description   |
|--------|---|
| 1      | Use multiple vias to help eliminate ground variations.                    |
| 2      | Put a solid ground plane under RF trace to achieve the desired impedance. |

### Copper keepout for test points

The following keepouts are required for all surface-mount or micro-mount devices. These keepouts are in addition to the other keepouts if using a PCB or chip antenna.

While the underside of the device is mostly coated with solder resist, we recommended the copper layer directly below the device be left open to avoid unintended contacts. Copper or vias must not interfere with the three exposed RF test points on the bottom of the device as shown in the following diagrams. These devices have a ground plane in the middle on the back side for shielding purposes, which can be affected by copper traces directly below the device.



**Copper keepout for the XBee 3 surface-mount**

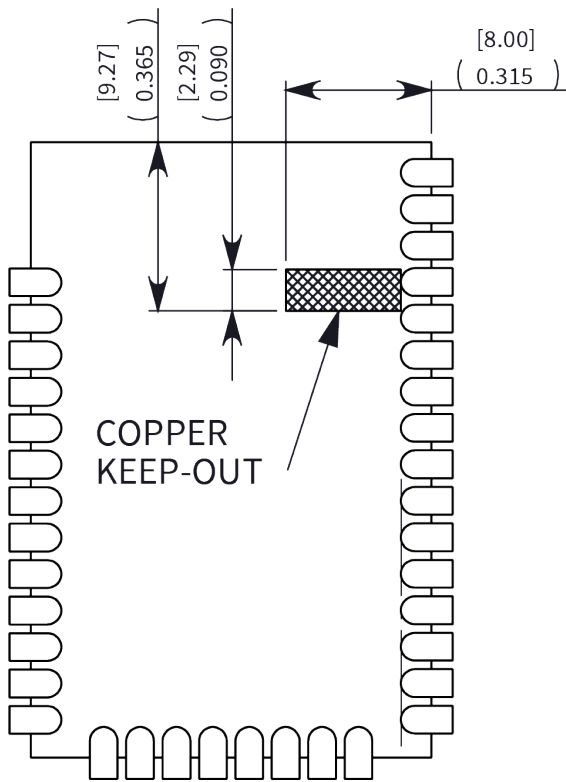

### Copper keepout for the XBee 3 Micro

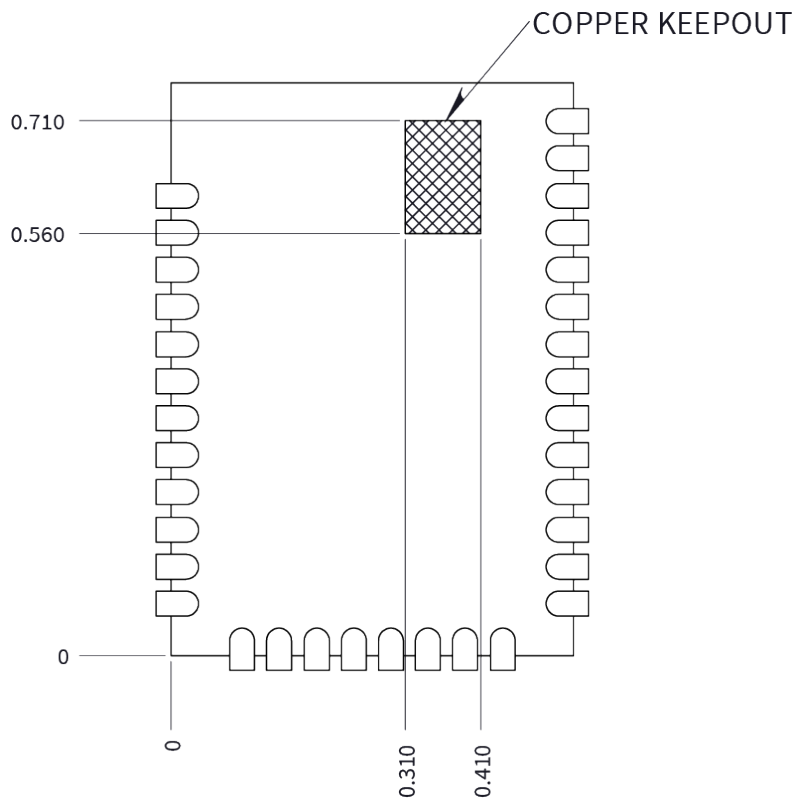

## Regulatory information

---

|  |    |
|--|----|
| United States (FCC) .....  | 44 |
| Europe (CE/UKCA) .....   | 54 |
| ISED (Innovation, Science and Economic Development Canada) ..... | 57 |
| Australia (RCM)/New Zealand .....                                | 58 |
| Brazil ANATEL .....  | 58 |
| Japan (TELEC) .....  | 59 |
| Mexico (IFETEL) .....  | 60 |
| South Korea .....  | 60 |

## United States (FCC)

XBee 3 RF Modules comply with Part 15 of the FCC rules and regulations. Compliance with the labeling requirements, FCC notices and antenna usage guidelines is required.

To fulfill FCC Certification, the OEM must comply with the following regulations:

1. The system integrator must ensure that the text on the external label provided with this device is placed on the outside of the final product.
2. RF Modules may only be used with antennas that have been tested and approved for use with the modules.

### OEM labeling requirements

---



**WARNING!** As an Original Equipment Manufacturer (OEM) you must ensure that FCC labeling requirements are met. You must include a clearly visible label on the outside of the final product enclosure that displays the following content:

---

#### **Required FCC Label for OEM products containing the XBee 3 RF Module**

Contains FCC ID: MCQ-XBEE3

This device complies with Part 15 of the FCC Rules. Operation is subject to the following two conditions: (1.) this device may not cause harmful interference and (2.) this device must accept any interference received, including interference that may cause undesired operation.

### FCC notices

**IMPORTANT:** XBee 3 RF Modules have been certified by the FCC for use with other products without any further certification (as per FCC section 2.1091). Modifications not expressly approved by Digi could void the user's authority to operate the equipment.

**IMPORTANT:** OEMs must test final product to comply with unintentional radiators (FCC section 15.107 & 15.109) before declaring compliance of their final product to Part 15 of the FCC Rules.

**IMPORTANT:** The RF module has been certified for remote and base radio applications. If the module will be used for portable applications, the device must undergo SAR testing.

This equipment has been tested and found to comply with the limits for a Class B digital device, pursuant to Part 15 of the FCC Rules. These limits are designed to provide reasonable protection against harmful interference in a residential installation. This equipment generates, uses and can radiate radio frequency energy and, if not installed and used in accordance with the instructions, may cause harmful interference to radio communications. However, there is no guarantee that interference will not occur in a particular installation.

If this equipment does cause harmful interference to radio or television reception, which can be determined by turning the equipment off and on, the user is encouraged to try to correct the interference by one or more of the following measures: Re-orient or relocate the receiving antenna, Increase the separation between the equipment and receiver, Connect equipment and receiver to outlets on different circuits, or Consult the dealer or an experienced radio/TV technician for help.

## FCC-approved antennas (2.4 GHz)

The XBee 3 RF Module can be installed using antennas and cables constructed with non-standard connectors (RPSMA, RPTNC, etc.) An adapter cable may be necessary to attach the XBee connector to the antenna connector.

The modules are FCC approved for fixed base station and mobile applications for the channels indicated in the tables below. If the antenna is mounted at least 20 cm (7.87 in) from nearby persons, the application is considered a mobile application. Antennas not listed in the table must be tested to comply with FCC Section 15.203 (Unique Antenna Connectors) and Section 15.247 (Emissions).

The antennas in the tables below have been approved for use with this module. Cable loss is required when using gain antennas as shown in the tables.

Digi does not carry all of these antenna variants. Contact Digi Sales for available antennas.

1. If using the RF module in a portable application (for example, if the module is used in a hand-held device and the antenna is less than 20 cm from the human body when the device is in operation), The integrator is responsible for passing additional Specific Absorption Rate (SAR) testing based on FCC rules 2.1091 and FCC Guidelines for Human Exposure to Radio Frequency Electromagnetic Fields, OET Bulletin and Supplement C. The testing results will be submitted to the FCC for approval prior to selling the integrated unit. The required SAR testing measures emissions from the module and how they affect the person.

### **XBee 3 RF module**

The following table shows the antennas approved for use with the XBee 3 RF module.

All antenna part numbers followed by an asterisk (\*) are not available from Digi. Consult with an antenna manufacturer for an equivalent option.

| Part number              | Type (description)  | Gain (dBi) | Application* | Min. separation | Required antenna cable loss (dB)      |  |
|--------------------------|---|------------|--------------|-----------------|---------------------------------------|--|
|                          |   |            |              |                 | 802.15.4 Based Protocols (Ex: Zigbee) | Bluetooth low energy technology (when available) |
| <b>Integral antennas</b> |   |            |              |                 |                                       |  |
| 29000313                 | Integral PCB antenna (surface-mount only)                         | 0.0        | Fixed/Mobile | 20 cm           | N/A                                   | N/A  |
| 29000710                 | Chip antenna (micro only)   | 0.0        | Fixed/Mobile | 20 cm           | N/A                                   | N/A  |
| 29000294                 | Integral PCB antenna (through-hole only)                          | -0.5 dBi   | Fixed/Mobile | 20 cm           | N/A                                   | N/A  |
| <b>Dipole antennas</b>   |   |            |              |                 |                                       |  |
| 31000019-01              | Integral Dipole (USB Adapter Only)                                | 0.87       | Portable     | N/A             | N/A                                   | N/A  |
| A24-HASM-450             | Dipole (Half-wave articulated RPSMA - 4.5")                       | 2.1        | Fixed        | 20 cm           | N/A                                   | N/A  |
| A24-HABSM*               | Dipole (Articulated RPSMA)  | 2.1        | Fixed        | 20 cm           | N/A                                   | N/A  |
| 29000095                 | Dipole (Half-wave articulated RPSMA - 4.5")                       | 2.1        | Fixed/Mobile | 20 cm           | N/A                                   | N/A  |
| A24-HABUF-P5I            | Dipole (Half-wave articulated bulkhead mount U.FL. w/ 5" pigtail) | 2.1        | Fixed/Mobile | 20 cm           | N/A                                   | N/A  |
| A24-HASM-525             | Dipole (Half-wave articulated RPSMA - 5.25")                      | 2.1        | Fixed        | 20 cm           | N/A                                   | N/A  |

| Part number   | Type (description)                         | Gain (dBi) | Application* | Min. separation | Required antenna cable loss (dB)      |  |
|---|--|------------|--------------|-----------------|---------------------------------------|--|
|   |  |            |              |                 | 802.15.4 Based Protocols (Ex: Zigbee) | Bluetooth low energy technology (when available) |
| <b>Omni-directional (Collinear Dipole Array) antennas</b> |  |            |              |                 |                                       |  |
| A24-F2NF  | Omni-directional (Fiberglass base station) | 2.1        | Fixed/Mobile | 20 cm           | N/A                                   | N/A  |
| A24-F3NF  | Omni-directional (Fiberglass base station) | 3.0        | Fixed/Mobile | 20 cm           | N/A                                   | N/A  |
| A24-F5NF  | Omni-directional (Fiberglass base station) | 5.0        | Fixed        | 20 cm           | N/A                                   | N/A  |
| A24-F8NF  | Omni-directional (Fiberglass base station) | 8.0        | Fixed        | 2 m             | N/A                                   | N/A  |
| A24-F9NF  | Omni-directional (Fiberglass base station) | 9.5        | Fixed        | 2 m             | N/A                                   | N/A  |
| A24-F10NF   | Omni-directional (Fiberglass base station) | 10.0       | Fixed        | 2 m             | N/A                                   | N/A  |
| A24-F12NF   | Omni-directional (Fiberglass base station) | 12.0       | Fixed        | 2 m             | N/A                                   | N/A  |
| A24-W7NF  | Omni-directional (Fiberglass base station) | 7.2        | Fixed        | 2 m             | N/A                                   | N/A  |
| A24-M7NF  | Omni-directional (Mag-mount base station)  | 7.2        | Fixed        | 2 m             | N/A                                   | N/A  |
| A24-F15NF   | Omni-directional (Fiberglass base station) | 15.0       | Fixed        | 2 m             | N/A                                   | N/A  |
| <b>Panel antennas</b>                                     |  |            |              |                 |                                       |  |
| A24-P8SF  | Flat Panel                                 | 8.5        | Fixed        | 2 m             | N/A                                   | N/A  |

| Part number               | Type (description)                 | Gain (dBi) | Application* | Min. separation | Required antenna cable loss (dB)      |  |
|---------------------------|------------------------------------|------------|--------------|-----------------|---------------------------------------|--|
|                           |                                    |            |              |                 | 802.15.4 Based Protocols (Ex: Zigbee) | Bluetooth low energy technology (when available) |
| A24-P8NF                  | Flat Panel                         | 8.5        | Fixed        | 2 m             | N/A                                   | N/A  |
| A24-P13NF                 | Flat Panel                         | 13.0       | Fixed        | 2 m             | N/A                                   | N/A  |
| A24-P14NF                 | Flat Panel                         | 14.0       | Fixed        | 2 m             | N/A                                   | N/A  |
| A24-P15NF                 | Flat Panel                         | 15.0       | Fixed        | 2 m             | N/A                                   | N/A  |
| A24-P16NF                 | Flat Panel                         | 16.0       | Fixed        | 2 m             | N/A                                   | N/A  |
| A24-P19NF                 | Flat Panel                         | 19.0       | Fixed        | 2 m             | N/A                                   | N/A  |
| <b>Yagi antennas</b>      |                                    |            |              |                 |                                       |  |
| A24-Y6NF                  | Yagi (6-element)                   | 8.8        | Fixed        | 2 m             | N/A                                   | N/A  |
| A24-Y7NF                  | Yagi (7-element)                   | 9.0        | Fixed        | 2 m             | N/A                                   | N/A  |
| A24-Y9NF                  | Yagi (9-element)                   | 10.0       | Fixed        | 2 m             | N/A                                   | N/A  |
| A24-Y10NF                 | Yagi (10-element)                  | 11.0       | Fixed        | 2 m             | N/A                                   | N/A  |
| A24-Y12NF                 | Yagi (12-element)                  | 12.0       | Fixed        | 2 m             | N/A                                   | N/A  |
| A24-Y13NF                 | Yagi (13-element)                  | 12.0       | Fixed        | 2 m             | N/A                                   | N/A  |
| A24-Y15NF                 | Yagi (15-element)                  | 12.5       | Fixed        | 2 m             | N/A                                   | N/A  |
| A24-Y16NF                 | Yagi (16-element)                  | 13.5       | Fixed        | 2 m             | N/A                                   | N/A  |
| A24-Y16RM                 | Yagi (16-element, RPSMA connector) | 13.5       | Fixed        | 2 m             | N/A                                   | N/A  |
| A24-Y18NF                 | Yagi (18-element)                  | 15.0       | Fixed        | 2 m             | N/A                                   | N/A  |
| <b>Patch antenna</b>      |                                    |            |              |                 |                                       |  |
| Taoglas<br>FXP74.07.0100A | 2.4 GHz band antenna               | 4          | Fixed        | 20 cm           | N/A                                   | N/A  |



### ***XBee3-PRO RF module***

The following table shows the antennas approved for use with the XBee3-PRO RF Module.

All antenna part numbers followed by an asterisk (\*) are not available from Digi. Consult with an antenna manufacturer for an equivalent option.

| Part number              | Type (description)                          | Gain (dBi) | Application* | Min separation | Required antenna cable loss (dB)      |  |
|--------------------------|---|------------|--------------|----------------|---------------------------------------|--|
|                          |   |            |              |                | 802.15.4 Based Protocols (Ex: Zigbee) | Bluetooth low energy technology (when available) |
| <b>Internal antennas</b> |   |            |              |                |                                       |  |
| 29000313                 | Integral PCB antenna (surface mount only)   | 0.0        | Fixed/Mobile | 20 cm          | N/A                                   | N/A  |
| 29000710                 | Chip antenna (micro only)                   | 0.0        | Fixed/Mobile | 20 cm          | N/A                                   | N/A  |
| 29000294                 | Integral PCB antenna (through-hole only)    | -0.5 dBi   | Fixed/Mobile | 20 cm          | N/A                                   | N/A  |
| <b>Dipole antennas</b>   |   |            |              |                |                                       |  |
| A24-HASM-450             | Dipole (Half-wave articulated RPSMA - 4.5") | 2.1        | Fixed        | 20 cm          | N/A                                   | N/A  |
| A24-HABSM*               | Dipole (Articulated RPSMA)                  | 2.1        | Fixed        | 20 cm          | N/A                                   | N/A  |
| 29000095                 | Dipole (Half-wave articulated RPSMA - 4.5") | 2.1        | Fixed/Mobile | 20 cm          | N/A                                   | N/A  |

| Part number   | Type (description)  | Gain (dBi) | Application* | Min separation | Required antenna cable loss (dB)      |  |
|---|---|------------|--------------|----------------|---------------------------------------|--|
|   |   |            |              |                | 802.15.4 Based Protocols (Ex: Zigbee) | Bluetooth low energy technology (when available) |
| A24-HABUF-P5I   | Dipole (Half-wave articulated bulkhead mount U.FL. w/ 5" pigtail) | 2.1        | Fixed/Mobile | 20 cm          | N/A                                   | N/A  |
| A24-HASM-525  | Dipole (Half-wave articulated RPSMA - 5.25")                      | 2.1        | Fixed        | 20 cm          | N/A                                   | N/A  |
| 31000019-01   | Integral Dipole (USB Adapter Only)                                | 0.87       | Fixed only   | 20 cm          | N/A                                   | N/A  |
| <b>Omni-directional (Collinear Dipole Array) antennas</b> |   |            |              |                |                                       |  |
| A24-F2NF  | Omni-directional (Fiberglass base station)                        | 2.1        | Fixed/Mobile | 20 cm          | N/A                                   | N/A  |
| A24-F3NF  | Omni-directional (Fiberglass base station)                        | 3.0        | Fixed/Mobile | 20 cm          | N/A                                   | N/A  |
| A24-F5NF  | Omni-directional (Fiberglass base station)                        | 5.0        | Fixed        | 20 cm          | N/A                                   | N/A  |
| A24-F8NF  | Omni-directional (Fiberglass base station)                        | 8.0        | Fixed        | 2 m            | N/A                                   | N/A  |
| A24-F9NF  | Omni-directional (Fiberglass base station)                        | 9.5        | Fixed        | 2 m            | N/A                                   | N/A  |

| Part number           | Type (description)                         | Gain (dBi) | Application* | Min separation | Required antenna cable loss (dB)      |  |
|-----------------------|--|------------|--------------|----------------|---------------------------------------|--|
|                       |  |            |              |                | 802.15.4 Based Protocols (Ex: Zigbee) | Bluetooth low energy technology (when available) |
| A24-F10NF             | Omni-directional (Fiberglass base station) | 10         | Fixed        | 2 m            | N/A                                   | N/A  |
| A24-F12NF             | Omni-directional (Fiberglass base station) | 12         | Fixed        | 2 m            | N/A                                   | N/A  |
| A24-W7NF              | Omni-directional (Fiberglass base station) | 7.2        | Fixed        | 2 m            | N/A                                   | N/A  |
| A24-M7NF              | Omni-directional (Mag-mount base station)  | 7.2        | Fixed        | 2 m            | N/A                                   | N/A  |
| A24-F15NF             | Omni-directional (Fiberglass base station) | 15.0       | Fixed        | 2 m            | N/A                                   | 2.0  |
| <b>Panel antennas</b> |  |            |              |                |                                       |  |
| A24-P8SF              | Flat Panel                                 | 8.5        | Fixed        | 2 m            | N/A                                   | N/A  |
| A24-P8NF              | Flat Panel                                 | 8.5        | Fixed        | 2 m            | N/A                                   | N/A  |
| A24-P13NF             | Flat Panel                                 | 13.0       | Fixed        | 2 m            | N/A                                   | N/A  |
| A24-P14NF             | Flat Panel                                 | 14.0       | Fixed        | 2 m            | N/A                                   | 1.0  |
| A24-P15NF             | Flat Panel                                 | 15.0       | Fixed        | 2 m            | N/A                                   | 2.0  |
| A24-P16NF             | Flat Panel                                 | 16.0       | Fixed        | 2 m            | N/A                                   | 3.0  |
| A24-P19NF             | Flat Panel                                 | 19.0       | Fixed        | 2 m            | 3.0                                   | 6.0  |

| Part number  | Type (description)                 | Gain (dBi) | Application* | Min separation | Required antenna cable loss (dB)      |  |
|--|------------------------------------|------------|--------------|----------------|---------------------------------------|--|
|  |                                    |            |              |                | 802.15.4 Based Protocols (Ex: Zigbee) | Bluetooth low energy technology (when available) |
| <b>Yagi antennas</b>   |                                    |            |              |                |                                       |  |
| A24-Y6NF   | Yagi (6-element)                   | 8.8        | Fixed        | 2 m            | N/A                                   | N/A  |
| A24-Y7NF   | Yagi (7-element)                   | 9.0        | Fixed        | 2 m            | N/A                                   | N/A  |
| A24-Y9NF   | Yagi (9-element)                   | 10.0       | Fixed        | 2 m            | N/A                                   | N/A  |
| A24-Y10NF  | Yagi (10-element)                  | 11.0       | Fixed        | 2 m            | N/A                                   | N/A  |
| A24-Y12NF  | Yagi (12-element)                  | 12.0       | Fixed        | 2 m            | N/A                                   | N/A  |
| A24-Y13NF  | Yagi (13-element)                  | 12.0       | Fixed        | 2 m            | N/A                                   | N/A  |
| A24-Y15NF  | Yagi (15-element)                  | 12.5       | Fixed        | 2 m            | N/A                                   | N/A  |
| A24-Y16NF  | Yagi (16-element)                  | 13.5       | Fixed        | 2 m            | N/A                                   | 0.5  |
| A24-Y16RM  | Yagi (16-element, RPSMA connector) | 13.5       | Fixed        | 2 m            | N/A                                   | 0.5  |
| A24-Y18NF  | Yagi (18-element)                  | 15.0       | Fixed        | 2 m            | N/A                                   | 2.0  |
| <b>Patch antenna</b>   |                                    |            |              |                |                                       |  |
| Taoglas FXP74.07.0100A   | 2.4 GHz band antenna               | 4          | Fixed        | 20 cm          | N/A                                   | N/A  |
| <p>* If using the RF module in a portable application (for example - if the module is used in a handheld device and the antenna is less than 20 cm from the human body when the device is in operation): The integrator is responsible for passing additional SAR (Specific Absorption Rate) testing based on FCC rules 2.1091 and FCC Guidelines for Human Exposure to Radio Frequency Electromagnetic Fields, OET Bulletin and Supplement C. The testing results will be submitted to the FCC for approval prior to selling the integrated unit. The required SAR testing measures emissions from the module and how they affect the person.</p> |                                    |            |              |                |                                       |  |

## RF exposure

If you are integrating the XBee 3 into another product, you must include the following Caution statement in OEM product manuals to alert users of FCC RF exposure compliance:

---



**CAUTION!** To satisfy FCC RF exposure requirements for mobile transmitting devices, a separation distance of 20 cm or more should be maintained between the antenna of this device and persons during device operation. To ensure compliance, operations at closer than this distance are not recommended. The antenna used for this transmitter must not be co-located in conjunction with any other antenna or transmitter.

---

## XBee 3 USB Adapter

The XBee 3 USB Adapter integrates an XBee 3 RF Module into its hardware. Due to output power limitations it is exempt from SAR testing. It is approved as a portable application.

## FCC publication 996369 related information

In Publication 996369 section D03, the FCC requires information concerning a module to be presented by OEM manufacturers. This section assists in answering or fulfilling these requirements.

### 2.1 General

No requirements are associated with this section.

### 2.2 List of applicable FCC rules

This module conforms to FCC Part 15.247.

### 2.3 Summarize the specific operational use conditions

Certain approved antennas require attenuation for operation. For the XBee 3, see [XBee 3 RF module](#). For the Pro XBee 3, see [XBee3-PRO RF module](#).

Host product user guides should include the antenna table if end customers are permitted to select antennas.

### 2.4 Limited module procedures

Not applicable.

### 2.5 Trace antenna designs

While it is possible to build a trace antenna into the host PCB, this requires at least a Class II permissive change to the FCC grant which includes significant extra testing and cost. If an embedded trace or chip antenna is desired, simply select the XBee 3 module variant with the preferred antenna.

### 2.6 RF exposure considerations

For RF exposure considerations see [RF exposure](#) and [FCC-approved antennas \(2.4 GHz\)](#).

Host product manufacturers need to provide end-users a copy of the “RF Exposure” section of the manual: [RF exposure](#).

## 2.7 Antennas

A list of approved antennas is provided for the XBee 3 product. For the XBee 3, see [XBee 3 RF module](#). For the Pro XBee 3, see [XBee3-PRO RF module](#).

## 2.8 Label and compliance information

Host product manufacturers need to follow the sticker guidelines outlined in [OEM labeling requirements](#).

## 2.9 Information on test modes and additional testing requirements

Contact a Digi sales representative for information on how to configure test modes for the XBee 3 product.

## 2.10 Additional testing, Part 15 Subpart B disclaimer

All final host products must be tested to be compliant to FCC Part 15 Subpart B standards. While the XBee3 unit was tested to be compliant to FCC unintentional radiator standards, FCC Part 15 Subpart B compliance testing is still required for the final host product. This testing is required for all end products, and XBee 3 Part 15 Subpart B compliance does not affirm the end product's compliance. See [FCC notices](#) for more details.

## Over-voltage detection

Over-Voltage detection sends out a modem status of **0x0D** indicating that the voltage supply limit has been exceeded. The device will still operate but limits the RF power level **PL** setting to a value of **3** when the operating voltage reaches 3.7 volts or higher to meet regulatory RF power requirements. While the device is in this mode of operation it will be forced into API mode for the over-voltage modem status to be sent out the serial port every 15 seconds when API mode is set to 1 or 2.

## Europe (CE/UKCA)

The XBee 3 RF Module has been tested for use in several European countries. For a complete list, refer to [www.digi.com/resources/certifications](http://www.digi.com/resources/certifications).

If XBee 3 RF Modules are incorporated into a product, the manufacturer must ensure compliance of the final product with articles 3.1a and 3.1b of the Radio Equipment Directive. A Declaration of Conformity must be issued for each of these standards and kept on file as described in the Radio Equipment Directive.

Furthermore, the manufacturer must maintain a copy of the XBee 3 RF Module user guide documentation and ensure the final product does not exceed the specified power ratings, antenna specifications, and/or installation requirements as specified in the user guide.

## Maximum power and frequency specifications

For the XBee 3 device:

When using the 802.15.4 RF physical layer:

- Maximum power: 8.61 mW (9.35 dBm) Equivalent Isotropically Radiated Power (EIRP).
- Frequencies: 5 MHz channel spacing, beginning at 2405 MHz and ending at 2480 MHz.

When using the Bluetooth low energy technology RF physical layer:

- Maximum power: 9.02 mW (9.55 dBm) Equivalent Isotropically Radiated Power (EIRP).
- Frequencies: 2 MHz channel spacing, beginning at 2402 MHz and ending at 2480 MHz.

## CE and UKCA OEM labeling requirements

The CE and UKCA markings must be clearly visible and legible when you affix it to the product. If this is not possible, you must attach these marks to the packaging (if any) or accompanying documents.

### CE labeling requirements

The “CE” marking must be affixed to a visible location on the OEM product. The following figure shows CE labeling requirements.

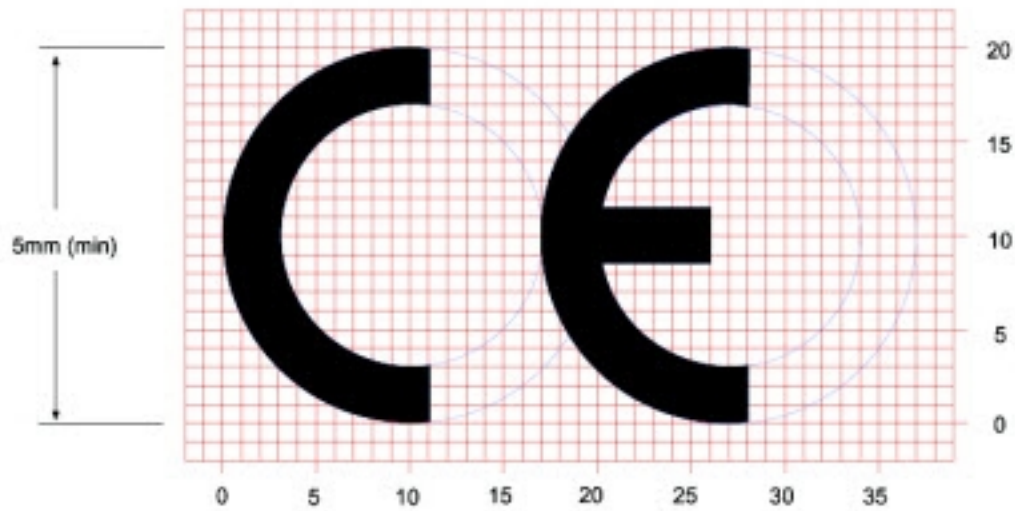

The CE mark shall consist of the initials “CE” taking the following form:

- If the CE marking is reduced or enlarged, the proportions given in the above graduated drawing must be respected.
- The CE marking must have a height of at least 5 mm except where this is not possible on account of the nature of the apparatus.
- The CE marking must be affixed visibly, legibly, and indelibly.

### **UK Conformity Assessed (UKCA) labeling requirements**



See [guidance/using-the-ukca-marking](#) for further details.

You must make sure that:

- if you reduce or enlarge the size of your marking, the letters forming the UKCA marking must be in proportion to the version set out below
- the UKCA marking is at least 5 mm in height – unless a different minimum dimension is specified in the relevant legislation
- the UKCA marking is easily visible, legible (from 1 January 2023 it must be permanently attached)
- the UKCA marking can take different forms (for example, the colour does not have to be solid), as long as it remains visible, legible and maintains the required proportions.

#### **Important note**

Digi customers assume full responsibility for learning and meeting the required guidelines for each country in their distribution market. Refer to the radio regulatory agency in the desired countries of operation for more information.

### **Declarations of conformity**

Digi has issued Declarations of Conformity for the XBee 3 RF Modules concerning emissions, EMC, and safety. For more information, see [www.digi.com/resources/certifications](http://www.digi.com/resources/certifications).

### **Antennas**

Testing for use of the XBee 3 in the European markets was performed with a 2.1 dBi dipole antenna. Use of an antenna with a gain of 2.1 dBi or less will ensure compliance with the spectrum requirements of the RED.

The following antennas have been tested for use with the XBee 3 RF Module. All antenna part numbers followed by an asterisk (\*) are not available from Digi. Consult with an antenna manufacturer for an equivalent option.



- Dipole (2.1 dBi, Omni-directional, Articulated RPSMA, Digi part number A24-HABSM)
- PCB antenna (surface mount boards only) (0.0 dBi)
- Chip antenna (micro form factor only) (0.0 dBi)
- PCB antenna (through-hole boards only) (-0.5 dBi)
- Integral Dipole (USB Adapter only) (0.87 dBi)

## ISED (Innovation, Science and Economic Development Canada)

### Labeling requirements

Labeling requirements for Industry Canada are similar to those of the FCC. A clearly visible label on the outside of the final product enclosure must display the following text.

#### For XBee 3

Contains Model XBEE3, IC: 1846A-XBEE3

The integrator is responsible for its product to comply with IC ICES-003 & FCC Part 15, Sub. B - Unintentional Radiators. ICES-003 is the same as FCC Part 15 Sub. B and Industry Canada accepts FCC test report or CISPR 22 test report for compliance with ICES-003.

This device complies with Industry Canada licence-exempt RSS standard(s). Operation is subject to the following two conditions: (1) this device may not cause interference, and (2) this device must accept any interference, including interference that may cause undesired operation of the device.

Le présent appareil est conforme aux CNR d'Industrie Canada applicables aux appareils radio exempts de licence. L'exploitation est autorisée aux deux conditions suivantes: (1) l'appareil ne doit pas produire de brouillage, et (2) l'utilisateur de l'appareil doit accepter tout brouillage radioélectrique subi, même si le brouillage est susceptible d'en compromettre le fonctionnement.

### RF Exposure

---



**CAUTION!** This equipment is approved for mobile and base station transmitting devices only. Antenna(s) used for this transmitter must be installed to provide a separation distance of at least 20 cm from all persons and must not be co-located or operating in conjunction with any other antenna or transmitter.

---



**ATTENTION!** Cet équipement est approuvé pour la mobile et la station base dispositifs d'émission seulement. Antenne(s) utilisé pour cet émetteur doit être installé pour fournir une distance de séparation d'au moins 20 cm à partir de toutes les personnes et ne doit pas être situé ou fonctionner en conjonction avec tout autre antenne ou émetteur.

---

#### ***XBee 3 USB Adapter***

The XBee 3 USB Adapter integrates an XBee 3 RF Module into its hardware. Special SAR testing was undertaken for the XBee 3 USB Adapter product to ensure it met IC standards. It is approved as a portable application.

### **Transmitters with Detachable Antennas**

This radio transmitter (IC: 1846A-XBEE3) has been approved by Industry Canada to operate with the antenna types listed in [FCC-approved antennas \(2.4 GHz\)](#) with the maximum permissible gain and required antenna impedance for each antenna type indicated. Antenna types not included in this list, having a gain greater than the maximum gain indicated for that type, are strictly prohibited for use with this device.

Le présent émetteur radio (IC: 1846A-XBEE3) a été approuvé par Industrie Canada pour fonctionner avec les types d'antenne énumérés ci-dessous et ayant un gain admissible maximal et l'impédance requise pour chaque type d'antenne. Les types d'antenne non inclus dans cette liste, ou dont le gain est supérieur au gain maximal indiqué, sont strictement interdits pour l'exploitation de l'émetteur.

### **Detachable Antenna**

Under Industry Canada regulations, this radio transmitter may operate using only an antenna of a type and maximum (or lesser) gain approved for the transmitter by Industry Canada. To reduce potential radio interference to other users, the antenna type and its gain should be so chosen that the equivalent isotropically radiated power (EIRP) is not more than that necessary for successful communication.

Conformément à la réglementation d'Industrie Canada, le présent émetteur radio peut fonctionner avec une antenne d'un type et d'un gain maximal (ou inférieur) approuvé pour l'émetteur par Industrie Canada. Dans le but de réduire les risques de brouillage radioélectrique à l'intention des autres utilisateurs, il faut choisir le type d'antenne et son gain de sorte que la puissance isotrope rayonnée équivalente (p.i.r.e.) ne dépasse pas l'intensité nécessaire à l'établissement d'une communication satisfaisante.

## **Australia (RCM)/New Zealand**

XBee 3 and XBee 3-PRO modules comply with requirements to be used in end products in Australia and New Zealand. All products with EMC and radio communications must have registered RCM and R-NZ marks. Registration to use the compliance mark will only be accepted from Australia or New Zealand manufacturers or importers, or their agents.

In order to have an RCM or R-NZ mark on an end product, a company must comply with a or b below.

- a. have a company presence in Australia or New Zealand.
- b. have a company/distributor/agent in Australia or New Zealand that will sponsor the importing of the end product.

Contact Digi for questions related to locating a contact in Australia and New Zealand.

## **Brazil ANATEL**

The XBee 3 ZigBee, DigiMesh and 802.15.4 radio modules comply with the requirements of ANATEL to be used in Brazil. The customer's product is subject to testing for conformity to the same Brazilian standards.

### **Modelo: XBee 3**

Atendimento à Regulamentação Anatel

Este equipamento não tem direito à proteção contra interferência prejudicial e não pode causar interferência em sistemas devidamente autorizados.

Este produto está homologado pela ANATEL, de acordo com os procedimentos regulamentados pela Resolução 242/2000, e atende aos requisitos técnicos aplicados.

Para maiores informações, consulte o site da ANATEL [www.anatel.gov.br](http://www.anatel.gov.br).



06329-18-01209

### Japan (TELEC)

The XBee 3 (not XBee 3-PRO) complies with Japan MIC Article 2 Paragraph 1, Item 19.

The customer product is subject to testing for conformity to the same Japanese standard.

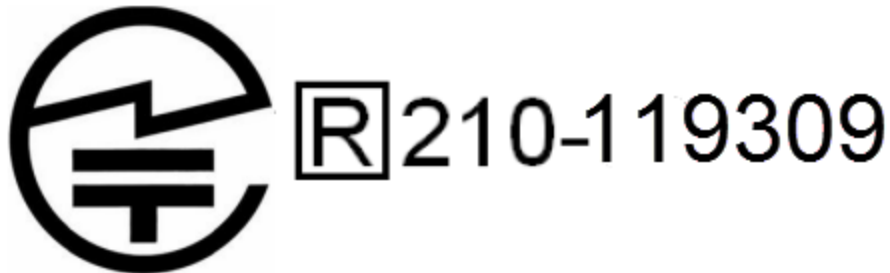

## Mexico (IFETEL)

Mexico does not have a “modular” approval for radio products.

If XBee 3 RF Modules are integrated into a product, the manufacturer must ensure compliance of the final product with all the requirements of Mexican regulations.

Manufacturer: Digi International

Country: USA

Brand: Digi

Model: XBEE3

Tariff Code (HS): 8517-62-15

IFETEL (IFT) number RCPDIXB19-1820 applies to these XBee3 radios:

|            |              |            |              |
|------------|--------------|------------|--------------|
| XB3-24ACM  | XB3-24ACM-J  | XB3-24ARM  | XB3-24ARM-J  |
| XB3-24AUM  | XB3-24AUM-J  | XB3-24DMCM | XB3-24DMCM-J |
| XB3-24DMRM | XB3-24DMRM-J | XB3-24DMUM | XB3-24DMUM-J |
| XB3-24Z8CM | XB3-24Z8CM-J | XB3-24Z8PS | XB3-24Z8PS-J |
| XB3-24Z8PT | XB3-24Z8PT-J | XB3-24Z8RM | XB3-24Z8RM-J |
| XB3-24Z8RS | XB3-24Z8RS-J | XB3-24Z8ST | XB3-24Z8ST-J |
| XB3-24Z8UM | XB3-24Z8UM-J | XB3-24Z8US | XB3-24Z8US-J |
| XB3-24Z8UT | XB3-24Z8UT-J |            |              |

## OEM labeling requirements



**WARNING!** The Original Equipment Manufacturer (OEM) must ensure that Mexico IFT labeling requirements are met.

The IFETEL number for the XBee3 product must be listed either on the end product, on the packaging, in the manual, or in the software with the following phrase:

“Este equipo contiene el módulo XBee3 con Número IFETEL: RCPDIXB19-1820”

or

“Este equipo contiene el módulo XBee3 con IFT #: RCPDIXB19-1820”

The following paragraph must also be present in the User Manual for the end product:

“La operación de este equipo está sujeta a las siguientes dos condiciones: (1) es posible que este equipo o dispositivo no cause interferencia perjudicial y (2) este equipo o dispositivo debe aceptar cualquier interferencia, incluyendo la que pueda causar su operación no deseada.”

## South Korea

The XBee 3 (not XBee 3-PRO) complies with South Korea's Korea Communications Commission (KCC) Clause 2, Article 58-2 of Radio Waves Act.

The customer's product is subject to testing for conformity to the same South Korea standards.



R-C-DIG-XBEE3

## **XBIB-C development boards**

---

This section describes the XBIB-C development boards and how to interact with them.

|  |    |
|--|----|
| XBIB-C Micro Mount reference .....         | 63 |
| XBIB-C SMT reference .....                 | 65 |
| XBIB-CU TH reference .....                 | 67 |
| XBIB-C-GPS reference .....                 | 69 |
| Interface with the XBIB-C-GPS module ..... | 71 |
| Attach the XBee 3 RF Module .....          | 72 |



| Number | Item                        | Description   |
|--------|-----------------------------|---|
| 1      | Secondary USB (USB MICRO B) | Secondary USB Connector for possible future use. Not used.  |
| 2      | Current Measure             | Large switch controls whether current measure mode is active or inactive. When inactive, current can freely flow to the VCC pin of the XBee. When active, the VCC pin of the XBee is disconnected from the 3.3 V line on the development board. This allows current measurement to be conducted by attaching a current meter across the jumper P10. |
| 3      | Battery Connector           | If desired, you can attach a battery to provide power to the development board. The voltage can range from 2 V to 5 V. The positive terminal is on the left.  |
| 4      | USB-C Connector             | Connects to your computer. This is connected to a USB to UART conversion chip that has the five UART lines passed to the XBee device. The UART Dip Switch can be used to disconnect these UART lines from the XBee.   |
| 5      | LED indicator               | Red: UART DOUT (modem sending serial/UART data to host)<br>Green: UART DIN (modem receiving serial/UART data from host)<br>White: ON/SLP/DIO9<br>Blue: Connection Status/DIO5<br>Yellow: RSSI/PWM0/DIO10  |
| 6      | User Buttons                | Comm DIO0 Button connects the Commissioning/DIO0 pin on the XBee Connector through to a 10 Ω resistor to GND when pressed.<br><br>RESET Button Connects to the RESET pin on the XBee Connector to GND when pressed.   |
| 7      | Breakout Connector          | This 40-pin connector can be used to connect to various XBee pins as shown on the silkscreen on the bottom of the board.  |
| 8      | UART Dip Switch             | This dip switch allows the user to disconnect any of the primary UART lines on the XBee from the USB to UART conversion chip. This allows for testing on the primary UART lines without the USB to UART conversion chip interfering. Push Dip switches to the right to disconnect the USB to UART conversion chip from the XBee.                    |
| 9      | Grove Connector             | This connector can be used to attach I2C enabled devices to the development board. Note that I2C needs to be available on the XBee in the board to use this functionality.<br>Pin 1: I2C_CLK/XBee DIO1<br>Pin2: I2C_SDA/XBee DIO11<br>Pin3: VCC<br>Pin4: GND  |
| 10     | Temp/Humidity Sensor        | This as a Texas Instruments HDC1080 temperature and humidity sensor. This part is accessible through I2C. Be sure that the XBee that is inserted into the development board has I2C if access to this sensor is desired.  |
| 11     | XBee Socket                 | This is the socket for the XBee (Micro form factor).  |





| Number | Item                        | Description   |
|--------|-----------------------------|---|
| 1      | Secondary USB (USB MICRO B) | Secondary USB Connector for possible future use. Not used.  |
| 2      | Current Measure             | Large switch controls whether current measure mode is active or inactive. When inactive, current can freely flow to the VCC pin of the XBee. When active, the VCC pin of the XBee is disconnected from the 3.3 V line on the dev board. This allows current measurement to be conducted by attaching a current meter across the jumper P10. |
| 3      | Battery Connector           | If desired, you can attach a battery to provide power to the development board. The voltage can range from 2 V to 5 V. The positive terminal is on the left.  |
| 4      | USB-C Connector             | Connects to your computer. This is connected to a USB to UART conversion chip that has the five UART lines passed to the XBee. The UART Dip Switch can be used to disconnect these UART lines from the XBee.  |
| 5      | LED indicator               | Red: UART DOUT (modem sending serial/UART data to host)<br>Green: UART DIN (modem receiving serial/UART data from host)<br>White: ON/SLP/DIO9<br>Blue: Connection Status/DIO5<br>Yellow: RSSI/PWM0/DIO10  |
| 6      | User Buttons                | Comm DIO0 Button connects the Commissioning/DIO0 pin on the XBee Connector through to a 10 Ω resistor to GND when pressed.<br><br>RESET Button Connects to the RESET pin on the XBee Connector to GND when pressed.   |
| 7      | Breakout Connector          | This 40-pin connector can be used to connect to various XBee pins as shown on the silkscreen on the bottom of the board.  |
| 8      | UART Dip Switch             | This dip switch allows the user to disconnect any of the primary UART lines on the XBee from the USB to UART conversion chip. This allows for testing on the primary UART lines without the USB to UART conversion chip interfering. Push Dip switches to the right to disconnect the USB to UART conversion chip from the XBee.            |
| 9      | Grove Connector             | This connector can be used to attach I2C enabled devices to the development board. Note that I2C needs to be available on the XBee in the board to use this functionality.<br>Pin 1: I2C_CLK/XBee DIO1<br>Pin2: I2C_SDA/XBee DIO11<br>Pin3: VCC<br>Pin4: GND  |
| 10     | Temp/Humidity Sensor        | This as a Texas Instruments HDC1080 temperature and humidity sensor. This part is accessible through I2C. Be sure that the XBee that is inserted into the Dev Board has I2C if access to this sensor is desired.  |
| 11     | XBee Socket                 | This is the socket for the XBee (SMT form factor)   |



| Number | Item                                       | Description  |
|--------|--|--|
| 1      | Secondary USB (USB MICRO B) and DIP Switch | <p>Secondary USB Connector for direct programming of modules on some XBee units. Flip the Dip switches to the right for I2C access to the board; flip Dip switches to the left to disable I2C access to the board. The USB_P and USB_N lines are always connected to the XBee, regardless of Dip switch setting.</p> <p>This USB port is not designed to power the module or the board. Do not plug in a USB cable here unless the board is already being powered through the main USB-C connector. Do not attach a USB cable here if the Dip switches are pushed to the right.</p> <hr/> <div style="display: flex; align-items: center;">  <p><b>WARNING!</b> Direct input of USB lines into XBee units or I2C lines not designed to handle 5V can result in the destruction of the XBee or I2C components. Could cause fire or serious injury. Do not plug in a USB cable here if the XBee device is not designed for it and do not plug in a USB cable here if the Dip switches are pushed to the right.</p> </div> <hr/> |
| 2      | Current Measure                            | <p>Large switch controls whether current measure mode is active or inactive. When inactive, current can freely flow to the VCC pin of the XBee. When active, the VCC pin of the XBee is disconnected from the 3.3 V line on the development board. This allows current measurement to be conducted by attaching a current meter across the jumper P10.</p>   |
| 3      | Battery Connector                          | <p>If desired, a battery can be attached to provide power to the development board. The voltage can range from 2 V to 5 V. The positive terminal is on the left.</p> <p>If the USB-C connector is connected to a computer, the power will be provided through the USB-C connector and not the battery connector.</p>   |
| 4      | USB-C Connector                            | <p>Connects to your computer and provides the power for the development board. This is connected to a USB to UART conversion chip that has the five UART lines passed to the XBee. The UART Dip Switch can be used to disconnect these UART lines from the XBee.</p>   |
| 5      | LED indicator                              | <p>Red: UART DOUT (modem sending serial/UART data to host)<br/>           Green: UART DIN (modem receiving serial/UART data from host)<br/>           White: ON/SLP/DIO9<br/>           Blue: Connection Status/DIO5<br/>           Yellow: RSSI/PWM0/DIO10</p>  |
| 6      | User Buttons                               | <p>Comm DIO0 Button connects the Commissioning/DIO0 pin on the XBee Connector through to a 10 Ω resistor to GND when pressed.</p> <hr/> <p>RESET Button Connects to the RESET pin on the XBee Connector to GND when pressed.</p>   |

| Number | Item                 | Description  |
|--------|----------------------|--|
| 7      | Breakout Connector   | This 40 pin connector can be used to connect to various XBee pins as shown on the silkscreen on the bottom of the board.   |
| 8      | UART Dip Switch      | This dip switch allows the user to disconnect any of the primary UART lines on the XBee from the USB to UART conversion chip. This allows for testing on the primary UART lines without the USB to UART conversion chip interfering. Push Dip switches to the right to disconnect the USB to UART conversion chip from the XBee. |
| 9      | Grove Connector      | This connector can be used to attach I2C enabled devices to the development board. Note that I2C needs to be available on the XBee in the board for this functionality to be used.<br>Pin 1: I2C_CLK/XBee DIO1<br>Pin2: I2C_SDA/XBee DIO11<br>Pin3: VCC<br>Pin4: GND   |
| 10     | Temp/Humidity Sensor | This as a Texas Instruments HDC1080 temperature and humidity sensor. This part is accessible through I2C. Be sure that the XBee that is inserted into the development board has I2C if access to this sensor is desired.   |
| 11     | XBee Socket          | This is the socket for the XBee (TH form factor).  |
| 12     | XBee Test Point Pins | Allows easy access for probes for all 20 XBee TH pins. Pin 1 is shorted to Pin 1 on the XBee and so on.  |

## XBIB-C-GPS reference

This picture shows the XBIB-C-GPS module and the table that follows explains the callouts in the picture.

---

**Note** This board is sold separately. You must also have purchased an XBIB-C through-hole, surface-mount, or micro-mount development board.

---

**Note** For a demonstration of how to use MicroPython to parse some of the GPS NMEA sentences from the UART, print them and report them to Digi Remote Manager, see [Run the MicroPython GPS demo](#).

---

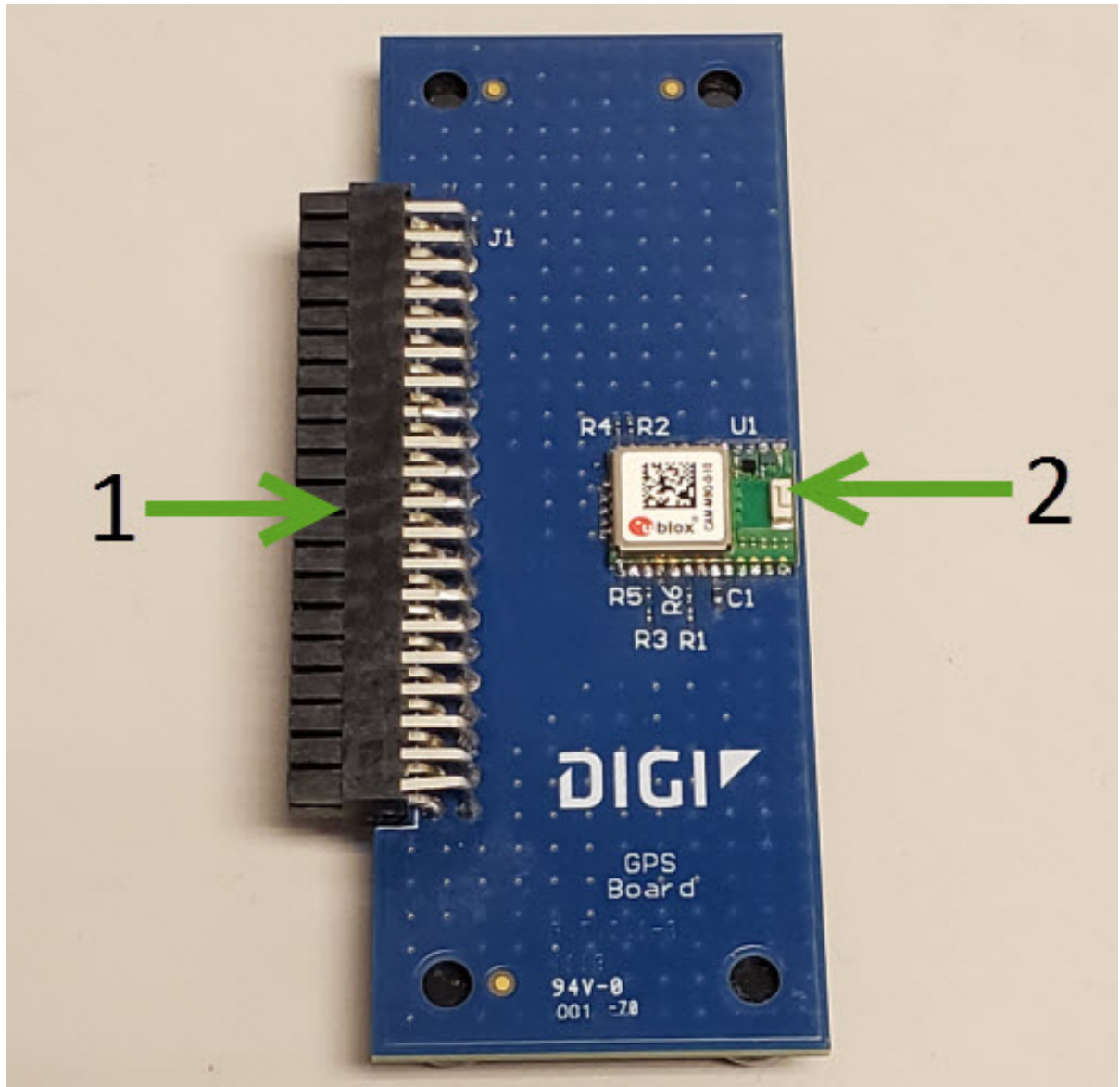

| Number | Item          | Description  |
|--------|---------------|--|
| 1      | 40-pin header | This header is used to connect the XBIB-C-GPS board to a compatible XBIB development board. Insert the XBIB-C-GPS module slowly with alternating pressure on the upper and lower parts of the connector. If added or removed improperly, the pins on the attached board could bend out of shape. |
| 2      | GPS unit      | This is the CAM-M8Q-0-10 module made by u-blox. This is what makes the GPS measurements. Proper orientation is with the board laying completely flat, with the module facing towards the sky.  |

## Interface with the XBIB-C-GPS module

The XBee 3 RF Module can interface with the XBIB-C-GPS board through the large 40-pin header. This header is designed to fit into XBIB-C development board. This allows the XBee 3 RF Module in the XBIB-C board to communicate with the XBIB-C-GPS board—provided the XBee device used has MicroPython capabilities (see [this link](#) to determine which devices have MicroPython capabilities). There are two ways to interface with the XBIB-C-GPS board: through the host board’s Secondary UART or through the I2C compliant lines.

The following picture shows a typical setup:



## I<sup>2</sup>C communication

There are two I<sup>2</sup>C lines connected to the host board through the 40-pin header, SCL and SDA. I<sup>2</sup>C communication is performed over an I<sup>2</sup>C-compliant Display Data Channel. The XBIB-C-GPS module operates in slave mode. The maximum frequency of the SCL line is 400 kHz. To access data through the I<sup>2</sup>C lines, the data must be queried by the connected XBee 3 RF Module.

For more information about I<sup>2</sup>C Operation see the **I<sup>2</sup>C** section of the [Digi Micro Python Programming Guide](#).

For more information on the operation of the XBIB-C-GPS board see the [CAM-M8 datasheet](#). Other CAM-M8 documentation is located [here](#).

## UART communication

There are two UART pins connected from the XBIB-C-GPS to the host board by the 40-pin header: RX and TX. By default, the UART on the XBIB-C-GPS board is active and sends GPS readings to the connected device's secondary UART pins. Readings are transmitted once every second. The baud rate of the UART is 9600 baud.

For more information about using Micro Python to communicate to the XBIB-C-GPS module, see [Class UART](#).

## Attach the XBee 3 RF Module

It is important to attach the device to the board correctly.



**WARNING!** Make sure the board is NOT powered when you plug in the XBee 3 RF Module. Never insert or remove the XBee 3 RF Module while the power is on!

Make sure the XBee 3 RF Module is oriented correctly and not upside down when you attach it to the board.

## Micro

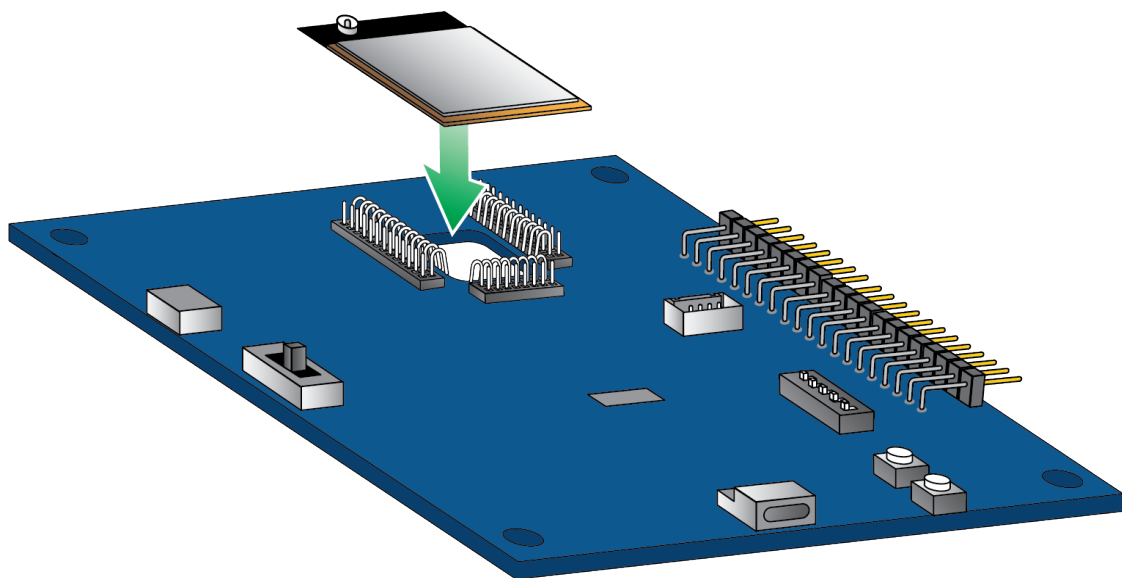



### Surface-mount

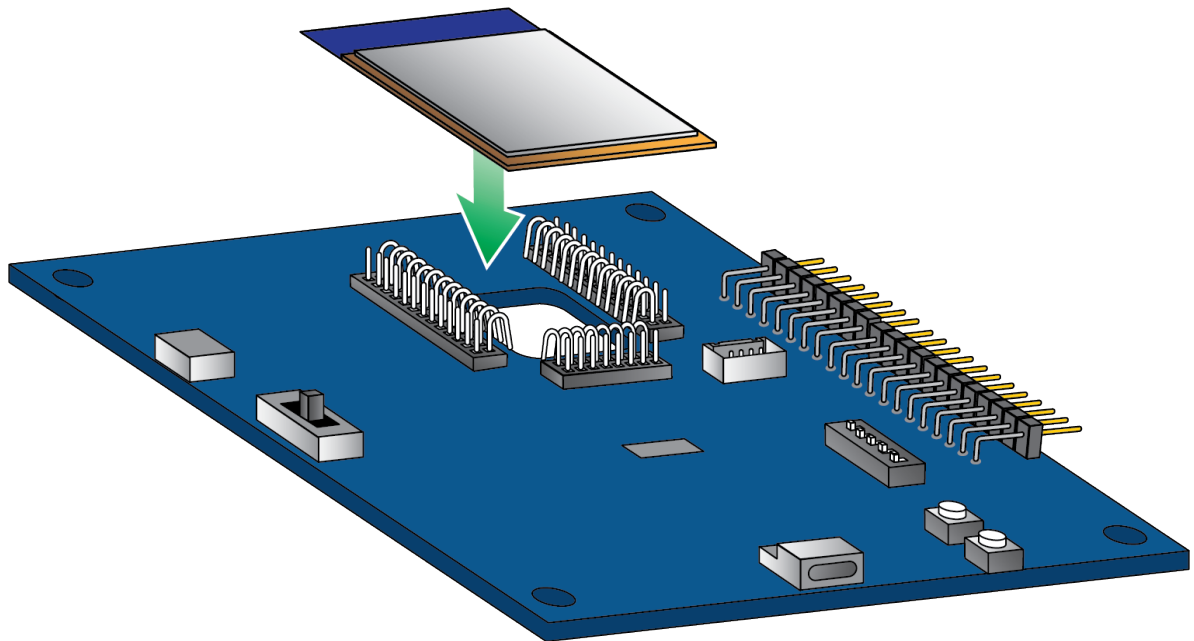

### Through-hole

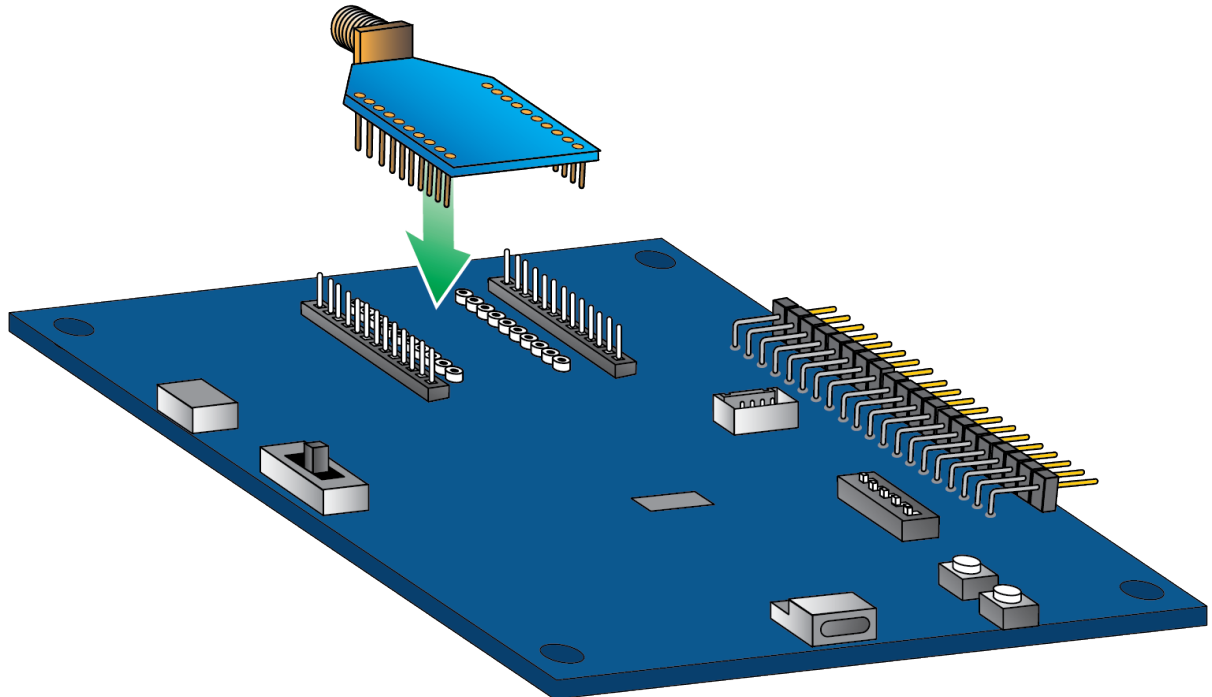

## Manufacturing information

---

The surface-mount and micro XBee 3 RF Module are designed for surface-mounting on the OEM PCB. It has castellated pads to allow for easy solder attaching and inspection. The pads are all located on the edge of the device so there are no hidden solder joints on these devices.

|                                       |    |
|---------------------------------------|----|
| Recommended solder reflow cycle ..... | 75 |
| Handling and storage .....            | 75 |
| Recommended footprint .....           | 75 |
| Flux and cleaning .....               | 77 |
| Reworking .....                       | 78 |

## Recommended solder reflow cycle

The following diagram shows the recommended solder reflow cycle.

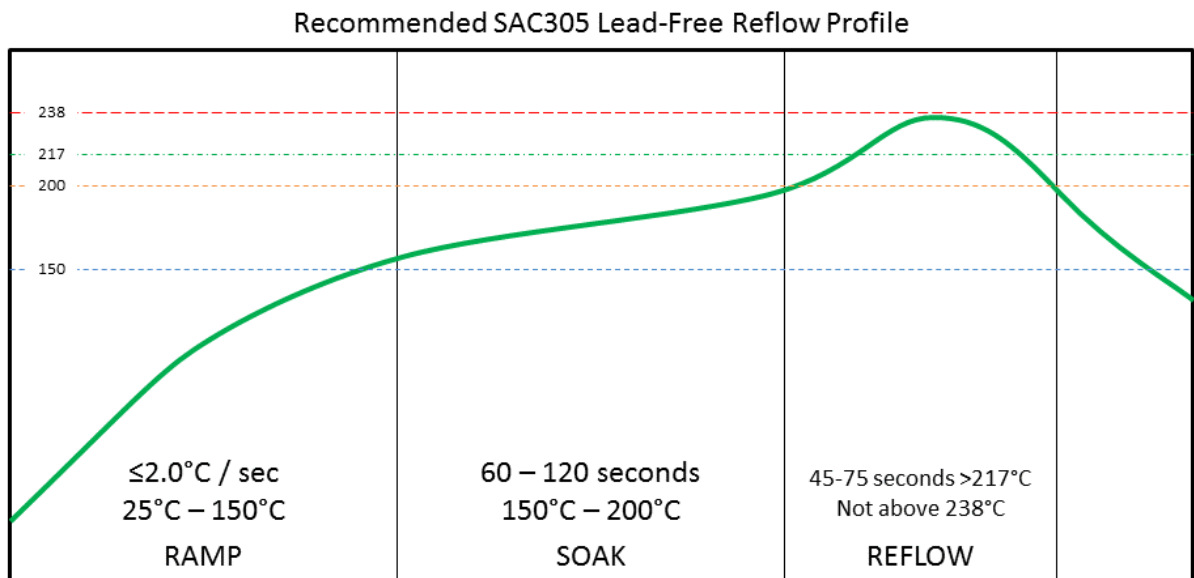

Recommended reflow profile only  
Modifications to profile may be required to fit specific application, process or design

The device reflows during this cycle, and must not be reflowed upside down. Be careful not to jar the device while the solder is molten, as parts inside the device can be removed from their required locations.

Hand soldering is possible and should be done in accordance with approved standards.

## Handling and storage

The XBee 3 RF Modules are level 3 Moisture Sensitive Devices. When using this kind of device, consider the relative requirements in accordance with standard IPC/JEDEC J-STD-020.

In addition, note the following conditions:

- Calculated shelf life in sealed bag: 12 months at <40 °C and <90% relative humidity (RH).
- Environmental condition during the production: 30 °C /60% RH according to IPC/JEDEC J-STD-033C, paragraphs 5 through 7.
- The time between the opening of the sealed bag and the start of the reflow process cannot exceed 168 hours if condition b) is met.
- Baking is required if conditions b) or c) are not met.
- Baking is required if the humidity indicator inside the bag indicates a RH of 10% more.
- If baking is required, bake modules in trays stacked no more than 10 high for 4-6 hours at 125 °C.

## Recommended footprint

We recommend that you use the following PCB footprints for surface-mounting. The dimensions without brackets are in inches, and those in brackets are in millimeters.

**XBee 3 surface-mount recommended footprint**

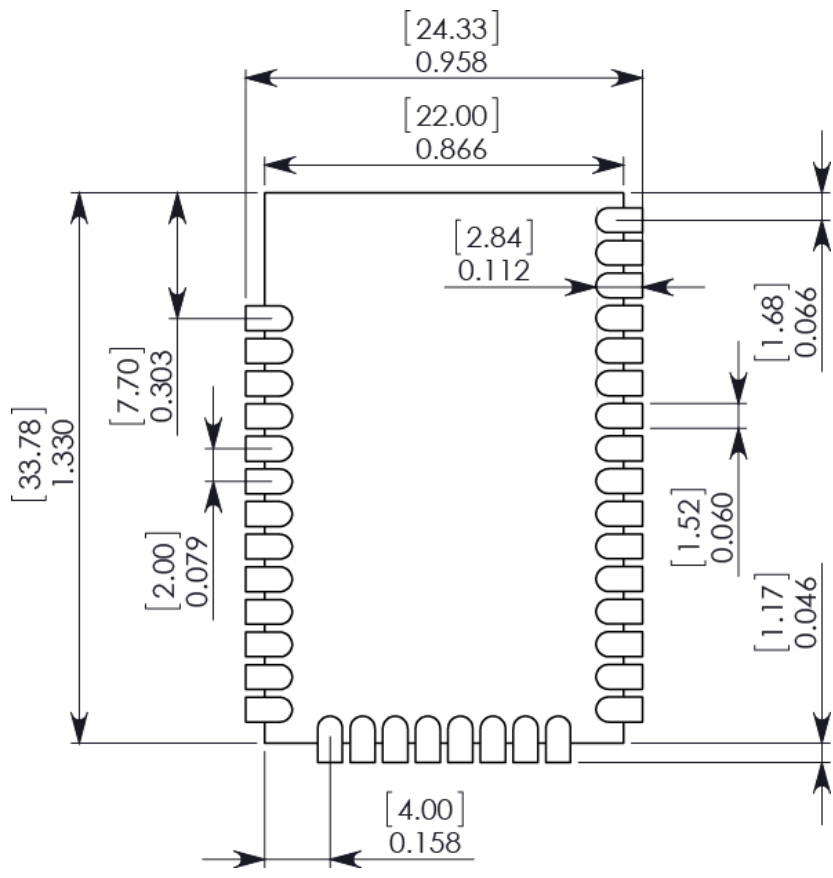

**XBee 3 Micro recommended footprint**

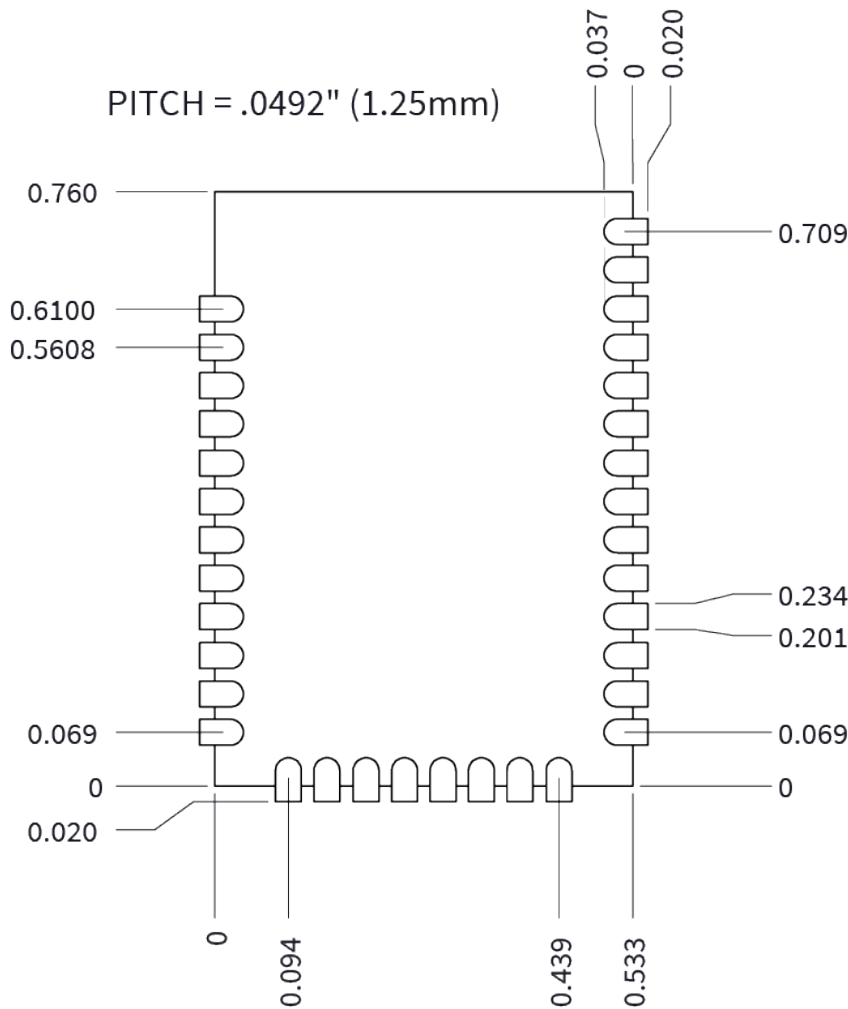

Match the solder footprint to the copper pads, but it may need to be adjusted depending on the specific needs of assembly and product standards. Recommended stencil thickness is 0.15 mm/0.005". Place the component last and set the placement speed to the slowest setting.

**Flux and cleaning**

Digi recommends that a “no clean” solder paste be used in assembling these devices. This eliminates the clean step and ensures unwanted residual flux is not left under the device where it is difficult to remove.

In addition the following issues can occur:

- Cleaning with liquids can result in liquid remaining under the shield or in the gap between the device and the OEM PCB. This can lead to unintended connections between pads on the device.
- The residual moisture and flux residue under the device are not easily seen during an inspection process.

Factory recommended best practice is to use a “no clean” solder paste to avoid these issues and ensure proper device operation.

## **Reworking**

Never perform rework on the device itself. The device has been optimized to give the best possible performance, and reworking the device itself will void warranty coverage and certifications. We recognize that some customers choose to rework and void the warranty. The following information serves as a guideline in such cases to increase the chances of success during rework, though the warranty is still voided.

The device may be removed from the OEM PCB by the use of a hot air rework station, or hot plate. Be careful not to overheat the device. During rework, the device temperature may rise above its internal solder melting point and care should be taken not to dislodge internal components from their intended positions.

## Troubleshooting

---

This section contains troubleshooting steps for the XBee 3 RF Module.

|                      |    |
|----------------------|----|
| Brownout issue ..... | 80 |
|----------------------|----|