

SPECIFICATION

Part No.	:	WSA.5800.A.101151
Product Name	:	Phoenix WSA.5800 Wi-Fi I-Bar 5.8GHz Antenna
Features	:	Wi-Fi/WLAN 5.8GHz Adhesive Mount Antenna 1m RG-174 cable with RP-SMA(M) connector Adhesive Mount Low Profile for Ease of Installation Fully Customizable Cable and Connector 105*30*7.7mm RoHS Compliant



1. Introduction

The Phoenix WSA.5800 I-Bar antenna is a robust and low profile antenna operating on the 5.8GHz band for Wi-Fi applications.

The Phoenix has a slim-line design, which allows for covert and convenient installation in any application, while its omnidirectional radiation pattern and 2.06dBi gain with 1 meter cable length ensure constant reception and transmission. It is manufactured and tested in a TS16949 first tier automotive approved facility and has undergone full PPAP design, reliability and quality audits.

The Phoenix is especially suited for applications such as first-tier automotive applications, aftermarket and telematics.

The Phoenix has exceptional industry performance characteristics considering its very low profile (just 7.7mm) and compact size (105*30mm).

This UV resistant antenna is designed to be mounted on glass or plastic but should not be mounted on a metal base. It comes with strong 3M double-sided adhesive for a permanent and secure fix to your application.

Cable lengths, types and connectors are fully customizable.

2. Specification

Wi-Fi		
Frequency	4900~5850MHz	
Efficiency (%)		
In free space	0.3m	56.64
	1m	39.81
	2m	24.24
	3m	14.57
	5m	5.34
On glass	0.3m	51.39
	1m	36.11
	2m	21.98
	3m	13.21
	5m	4.84
On the 2mm ABS	0.3m	58.87
	1m	41.37
	2m	25.18
	3m	15.13
	5m	5.54
Average Gain (dBi)		
In free space	0.3m	-2.48
	1m	-4.01
	2m	-6.17
	3m	-8.39
	5m	-12.77
On glass	0.3m	-2.90
	1m	-4.43
	2m	-6.59
	3m	-8.81
	5m	-13.19
On the 2mm ABS	0.3m	-2.31
	1m	-3.84
	2m	-6.00
	3m	-8.22
	5m	-12.59



Peak Gain (dBi)		
In free space	0.3m	3.04
	1m	1.54
	2m	-0.48
	3m	-2.58
	5m	-6.78
On glass	0.3m	4.08
	1m	2.46
	2m	0.26
	3m	-2.04
	5m	-6.29
On the 2mm ABS	0.3m	3.93
	1m	2.43
	2m	0.33
	3m	-1.81
	5m	-6.01
Return loss	< -10 dB	
VSWR	≤ 2:1	
Impedance	50Ω	
Polarization	Linear	
Radiation Pattern	Omnidirectional	
Input Power	2W	
MECHANICAL		
Dimensions	105*30*7.7mm	
Casing	PC/ABS	
Connector	RP-SMA(M)	
Cable	RG-174	
Weight	50g	
ENVIRONMENTAL		
Temperature Range	-40°C to 85°C	

3. Antenna Characteristics

3.1 Antenna Test Setup

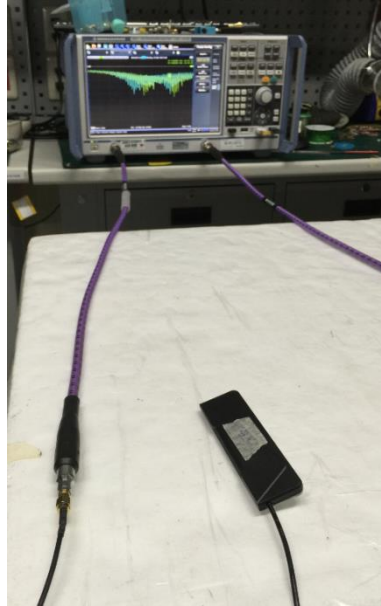

In free space

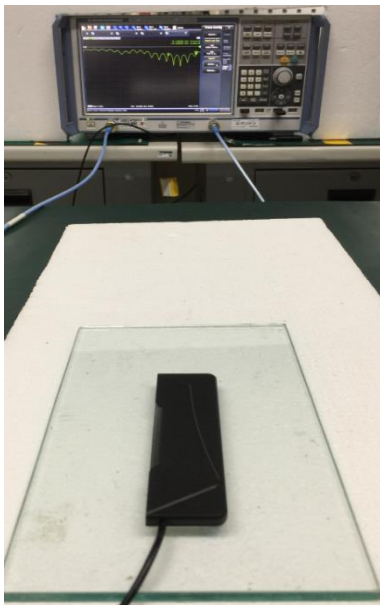

On glass

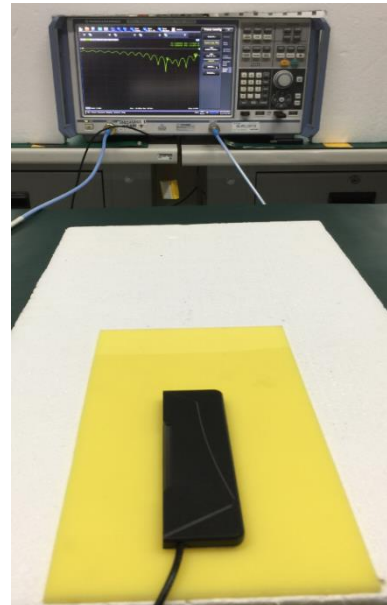

On the 2mm ABS



3.2 Return Loss

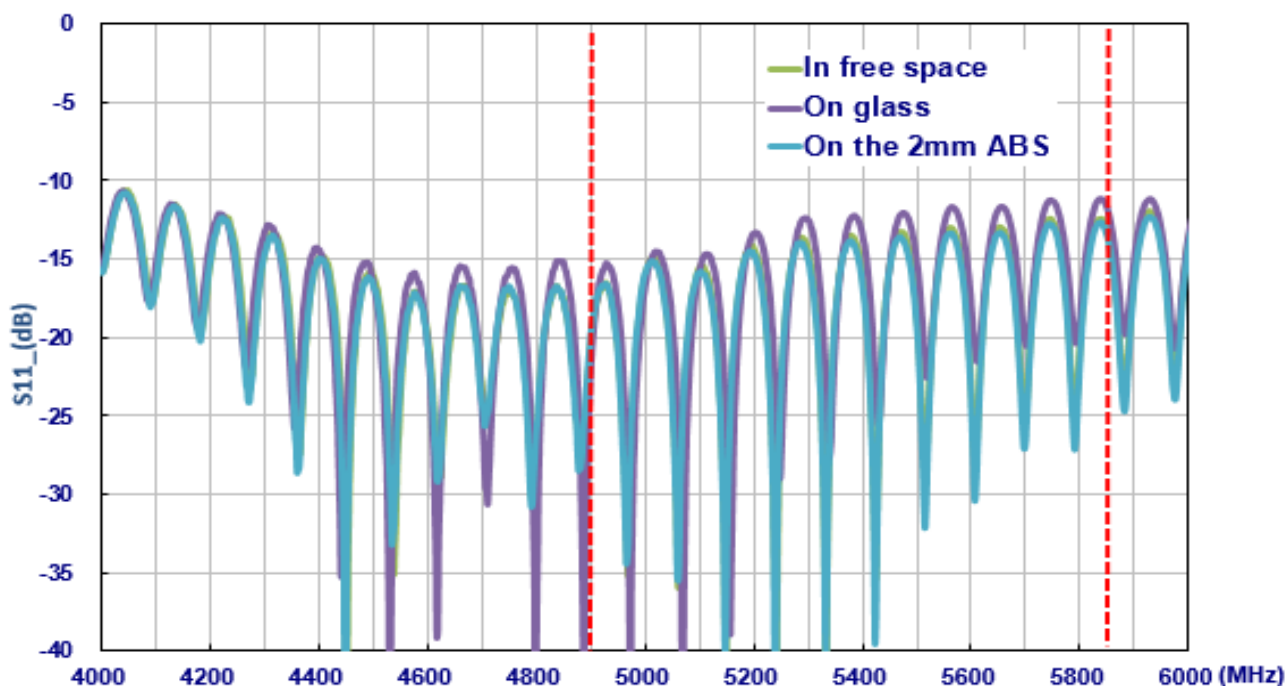

3.3 Efficiency

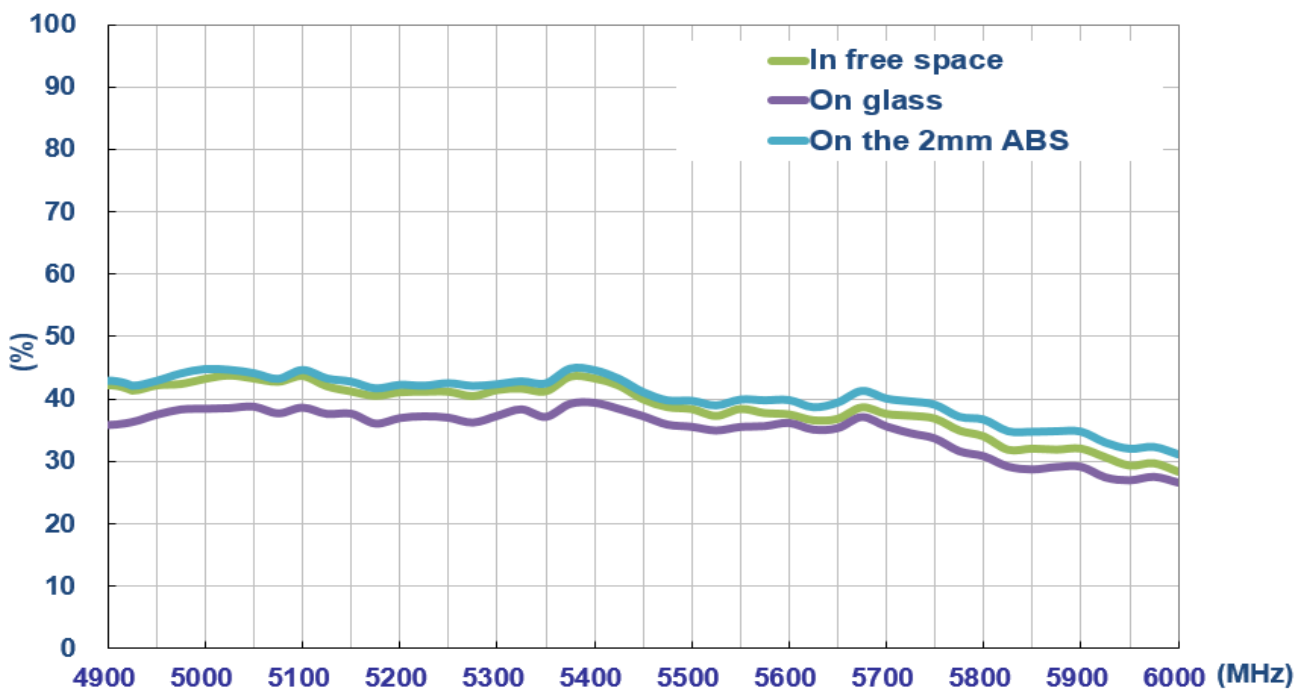



3.4 Peak Gain

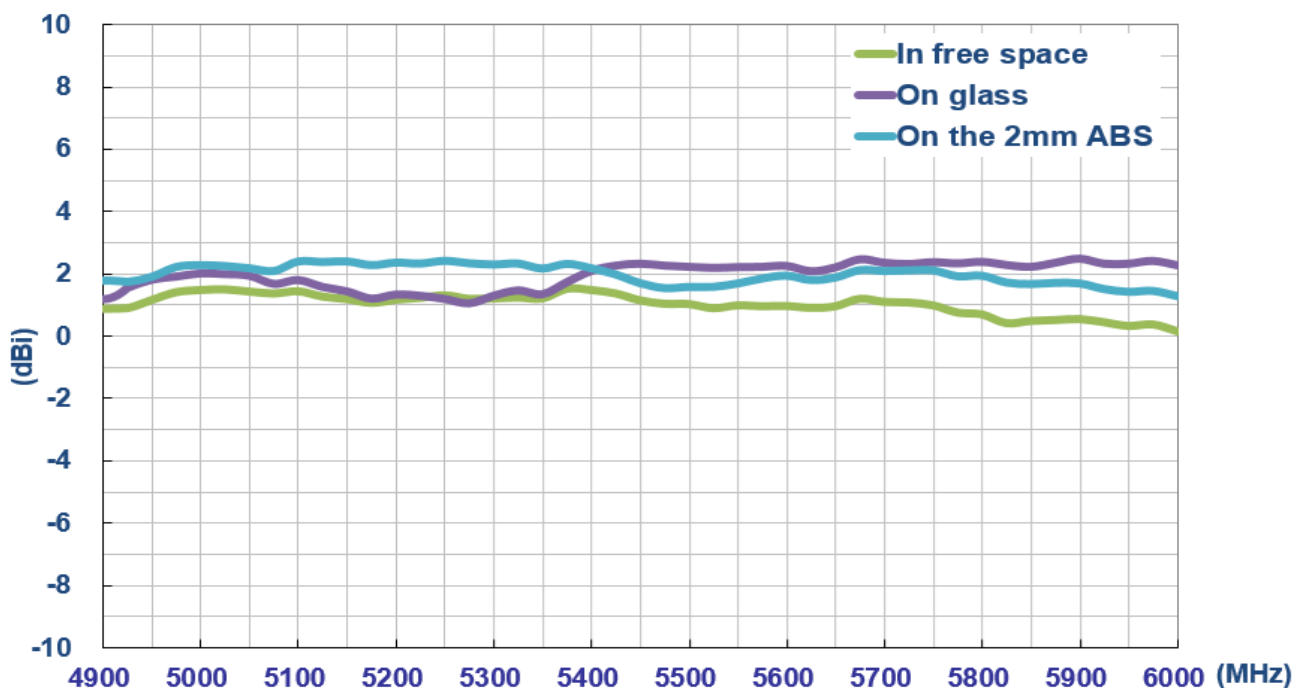

3.5 Average Gain

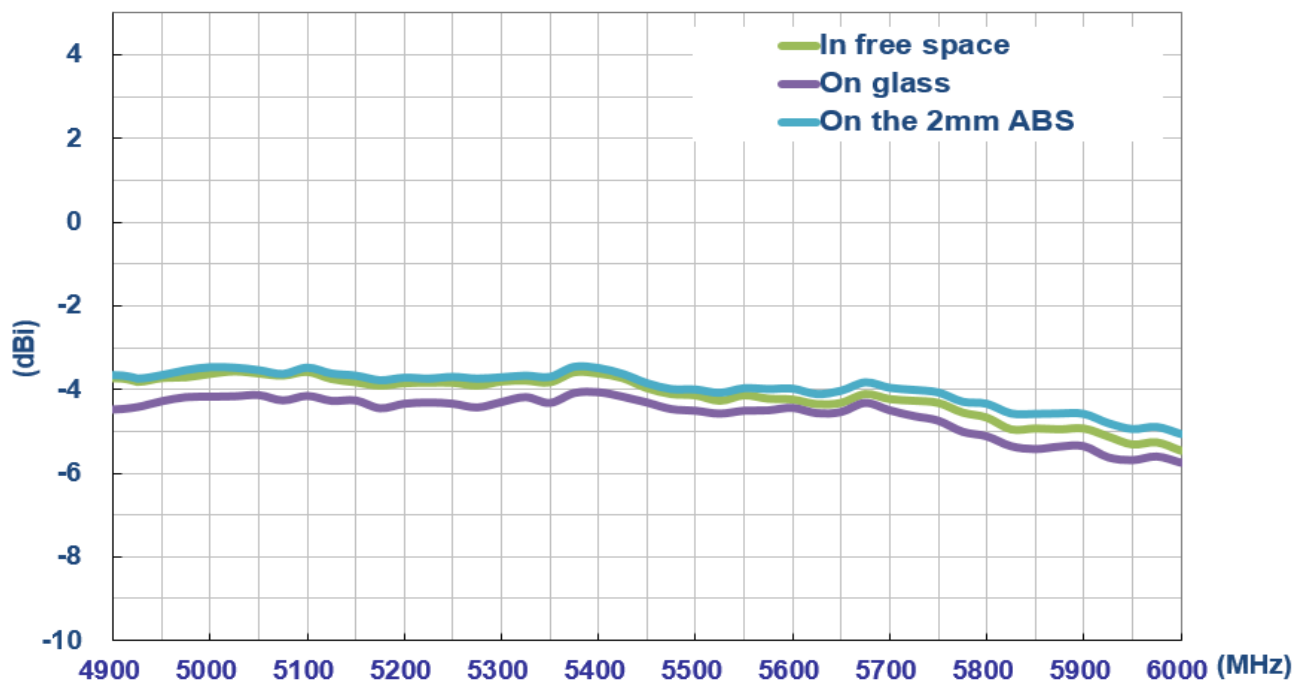



4. Antenna Radiation Patterns

4.1 Antenna Setup (Antenna testing Setup in ETS Anechoic Chamber)

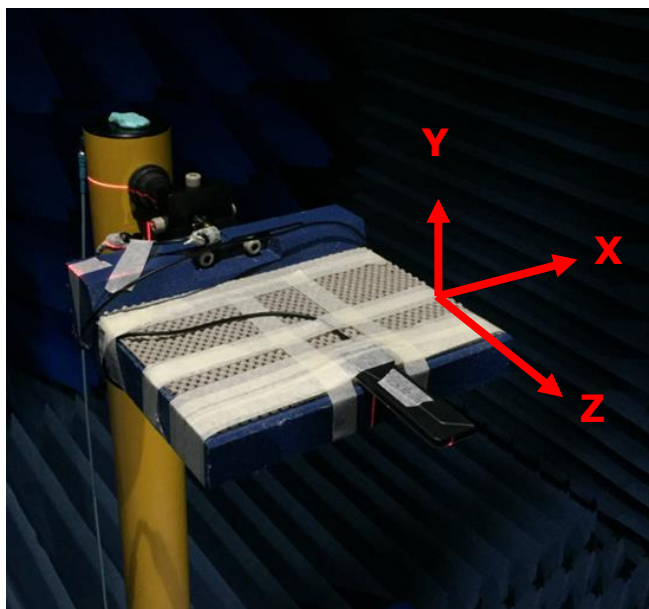

In free space

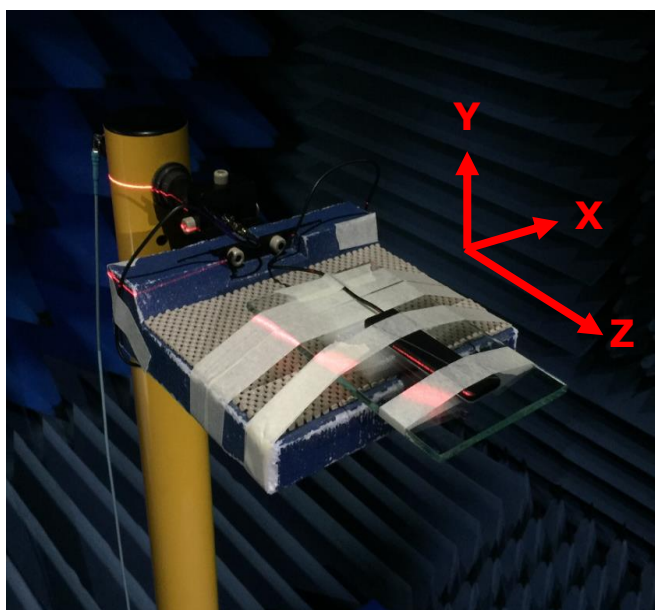

On glass

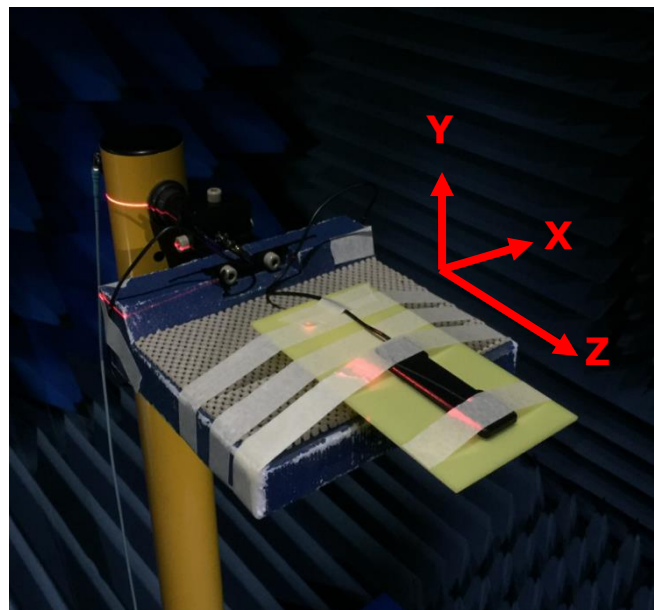

On the 2mm ABS



4.2 2D Radiation Patterns

4.2.1 In free space

XY Plane

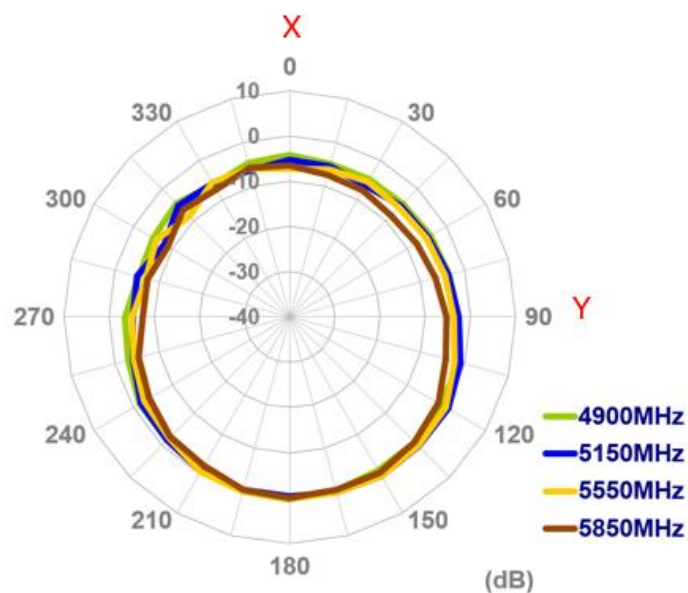

XZ Plane

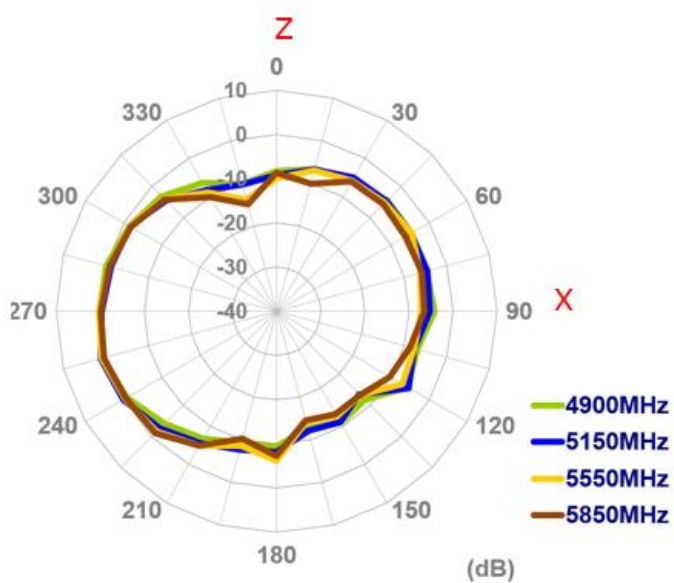

YZ Plane

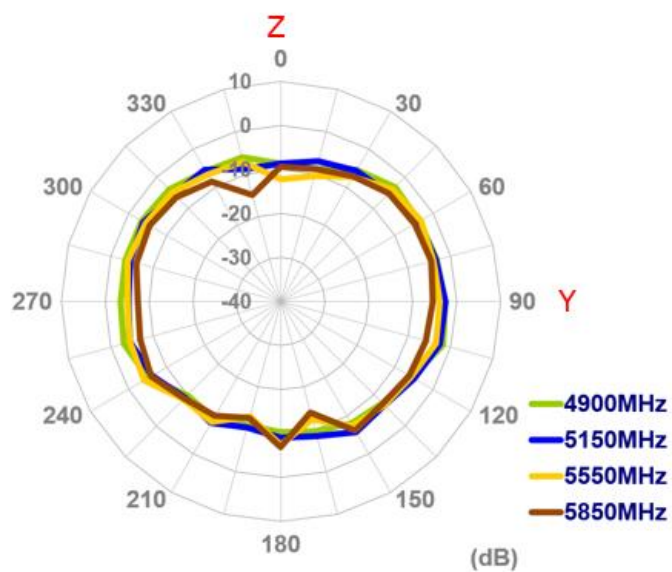



4.2.2 On glass

XY Plane

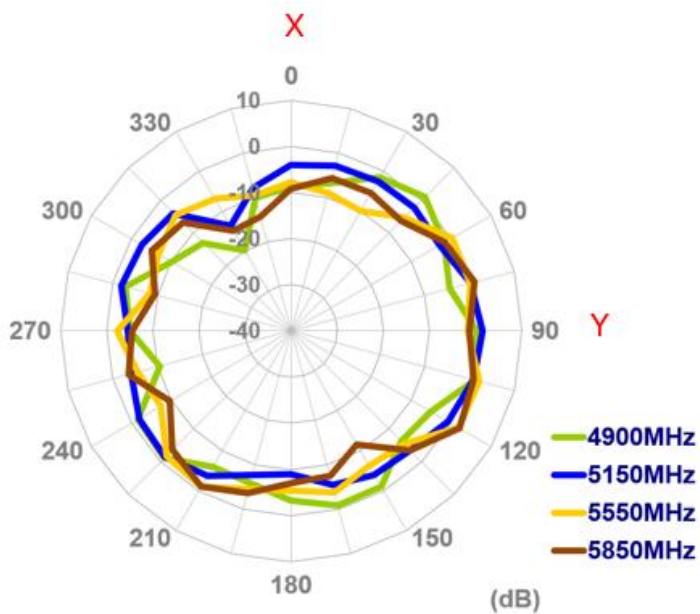

ZX Plane

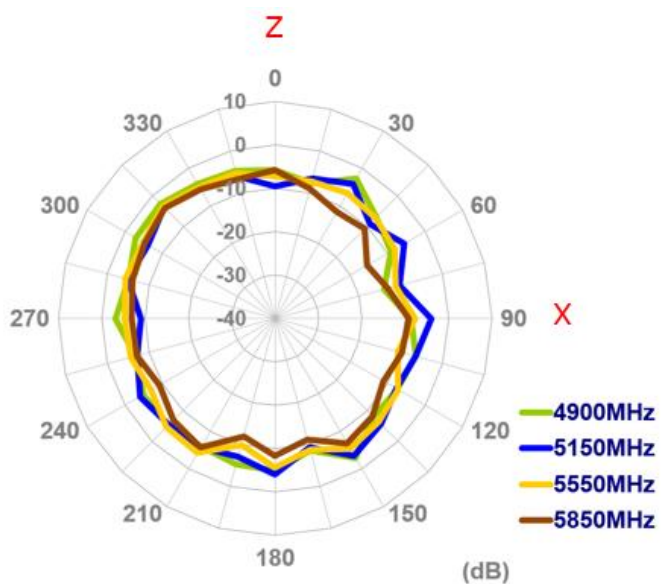

ZY Plane

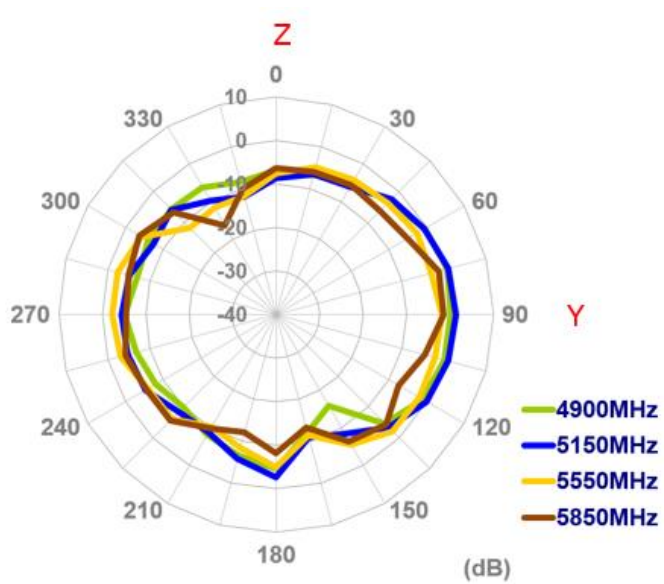



4.2.3 On the 2mm ABS

XY Plane

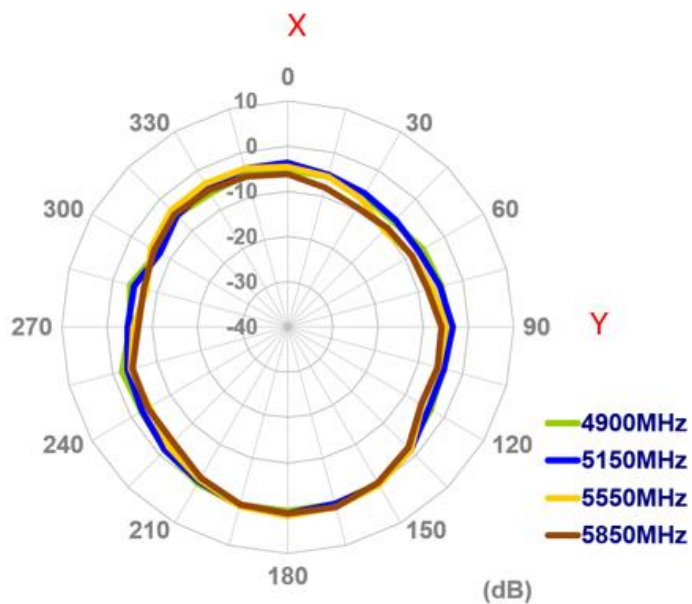

ZX Plane

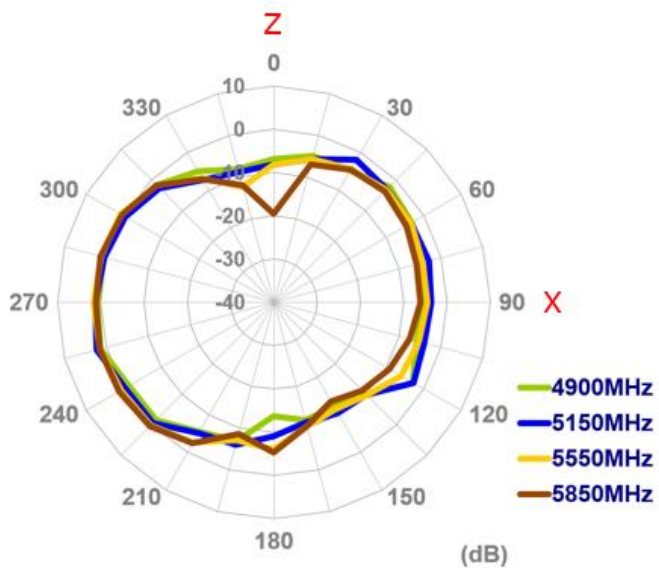

ZY Plane

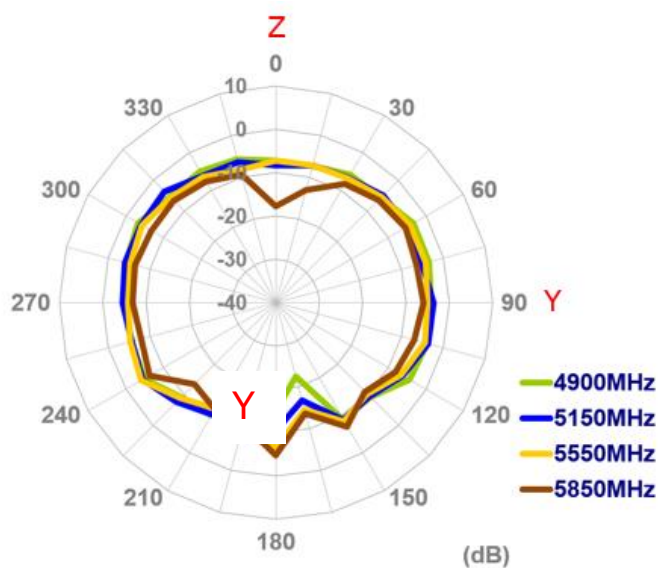

4.3 Antenna 3D Radiation Pattern

4.3.1 In free space

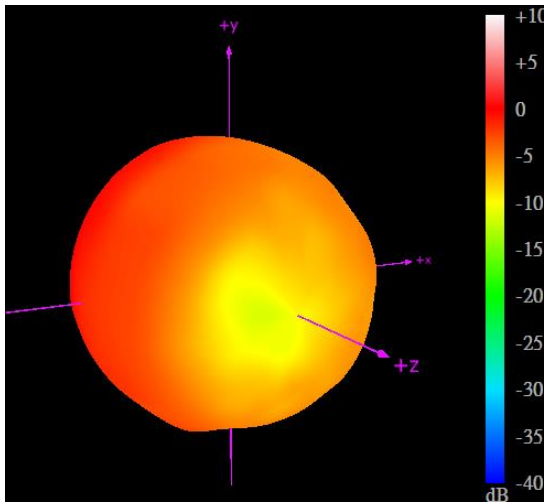

4900MHz

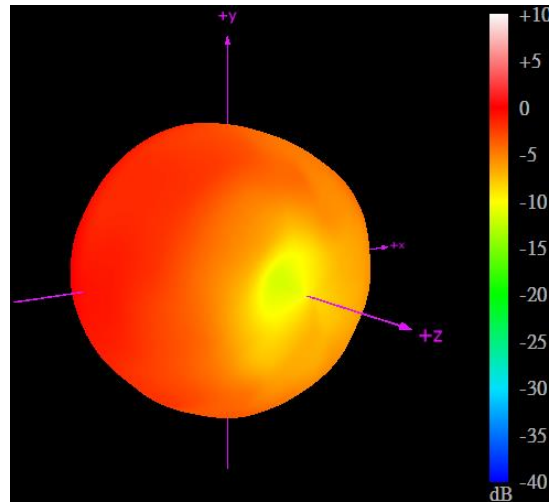

5150MHz

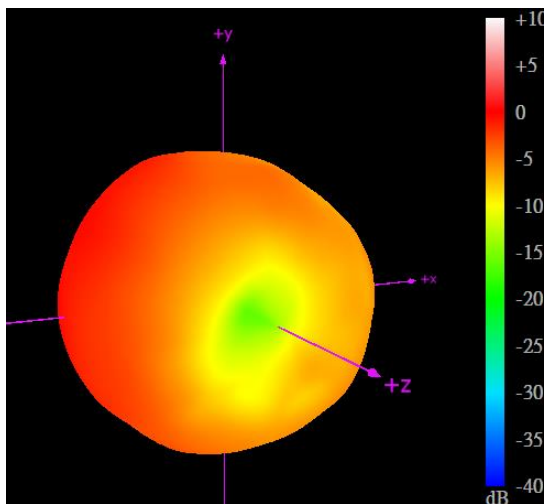

5550MHz

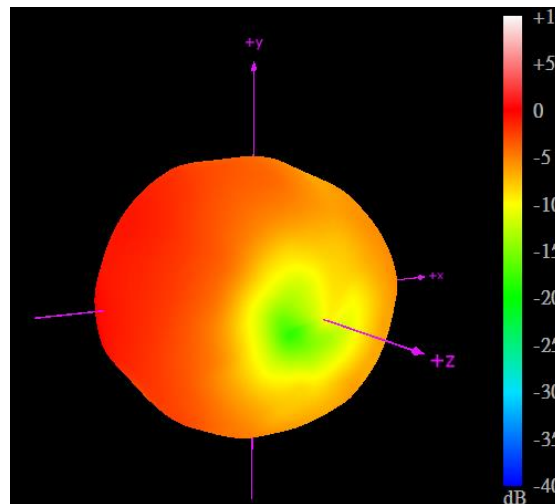

5850MHz



4.3.2 On Glass

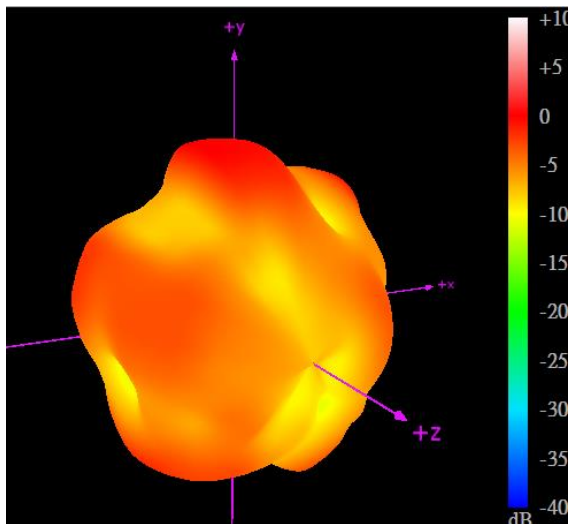

4900MHz

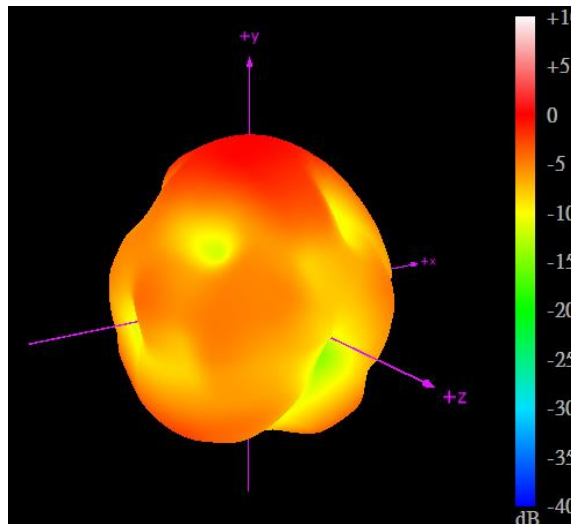

5150MHz

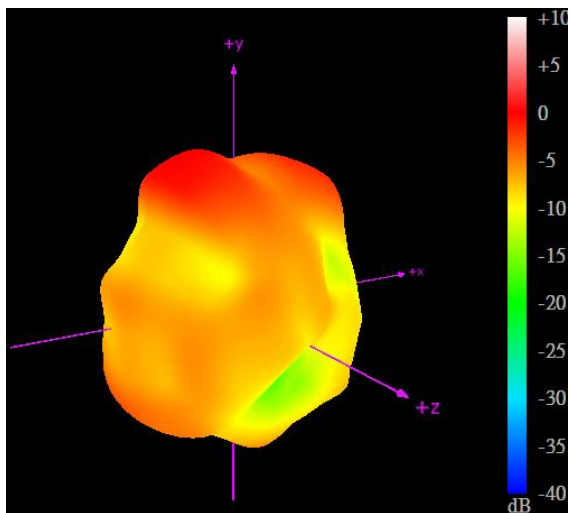

5550MHz

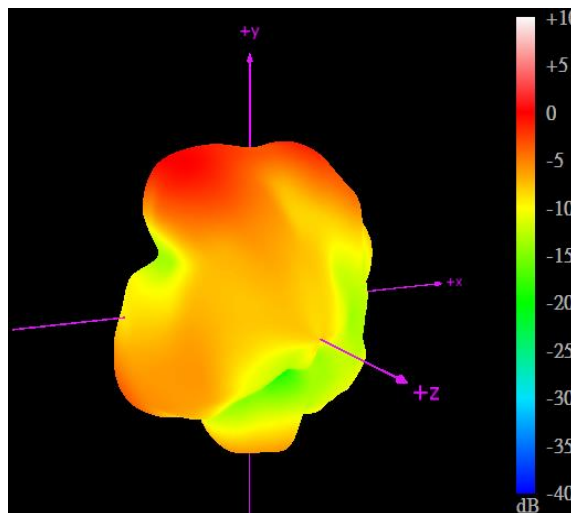

5850MHz



4.3.3 On 2mm ABS

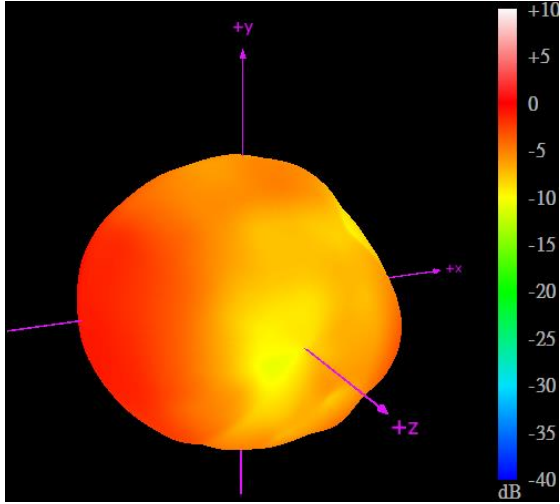

4900MHz

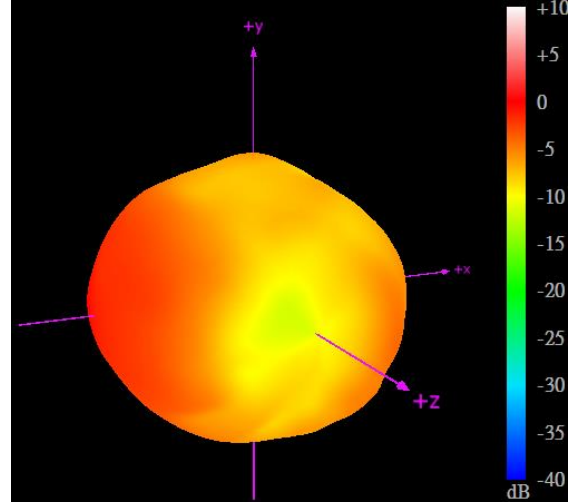

5150MHz

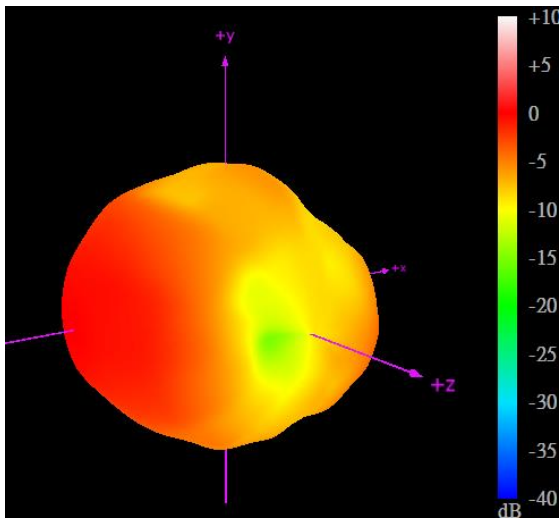

5550MHz

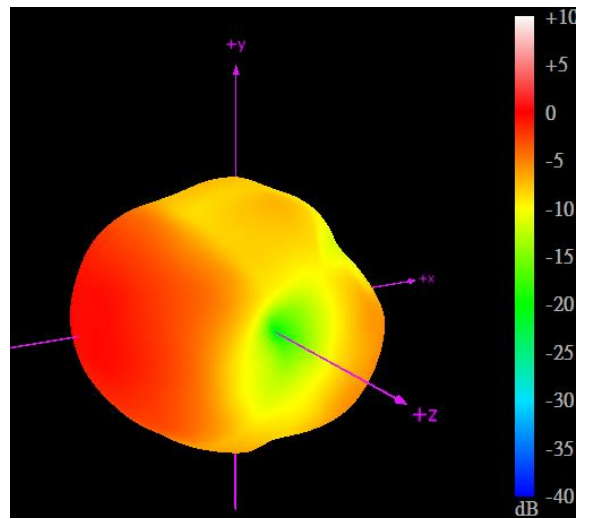

5850MHz



5. Drawing (Unit: mm)

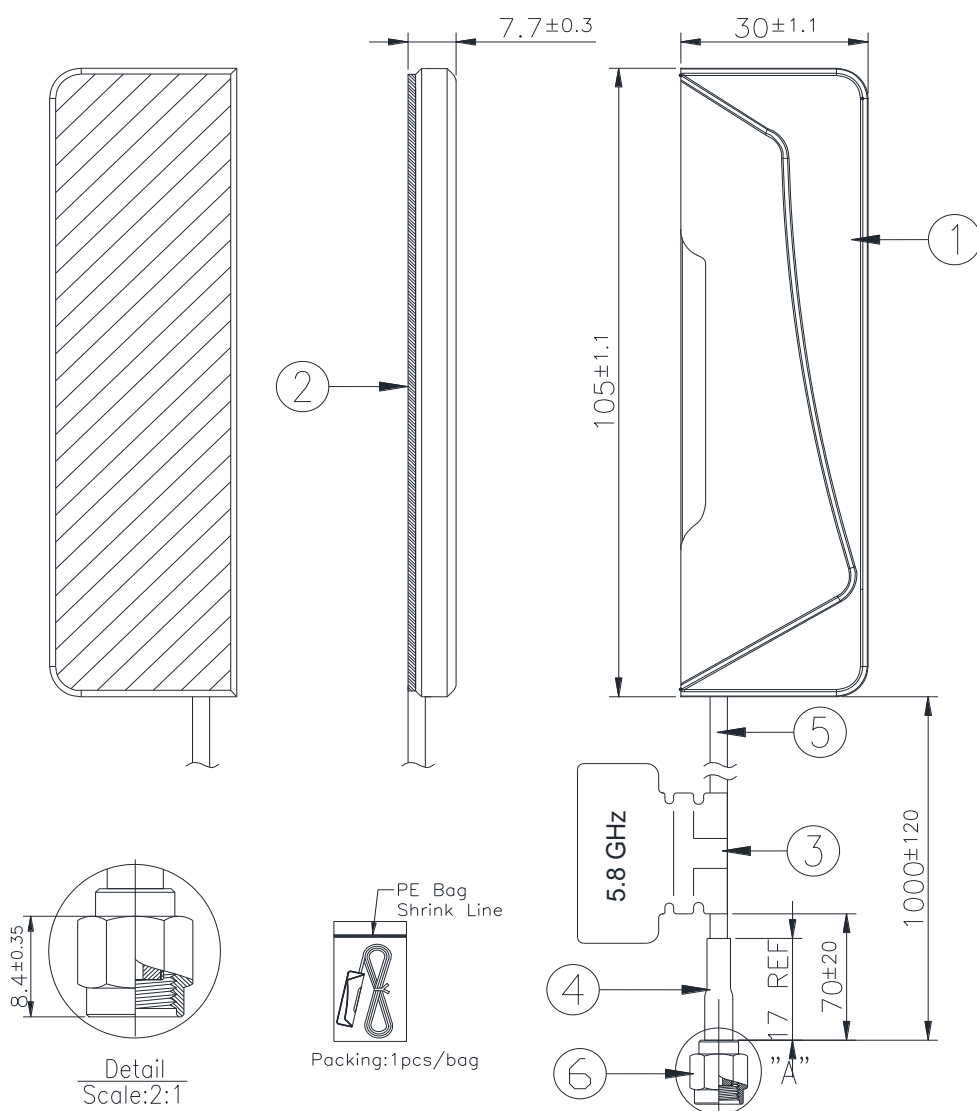

	Name	P/N	Material	Finish	QTY
1	Housing	000112G000015A	PC+ABS	Black	1
2	Double Sided Adhesive	001011J000015A	3M 1600T	Blue Liner	1
3	5.8 GHz Label	001016E020000A	Coated Paper	Light Purple	1
4	Heat Shrink Tube	001315C020000A	PE	Black	1
5	RG174 Coaxial Cable	301315C000000A	PVC	Black	1
6	RP-SMA(M)	200214E000015A	Brass	Au Plated	1



6. Packaging

WSA.5800.A.101151

Packaging Specifications

1pcs WSA.5800.A.101151 per PE Bag
Bag Dimensions - 190 x 70mm
Weight - 35g

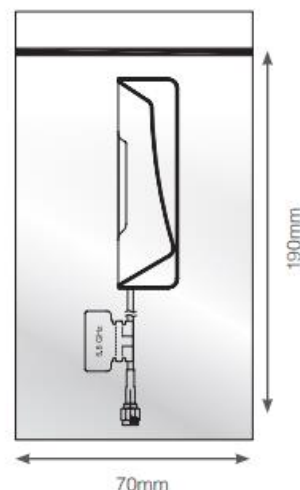

200 pcs WSA.5800.A.101151 per carton
Carton - 400x 330 x 220mm
Weight - 7.1Kg

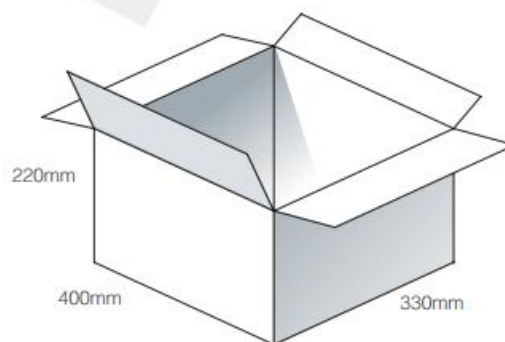

Pallet Dimensions 120 x 110x 150cm
54 Cartons per Pallet
9 Cartons per layer
6 Layers

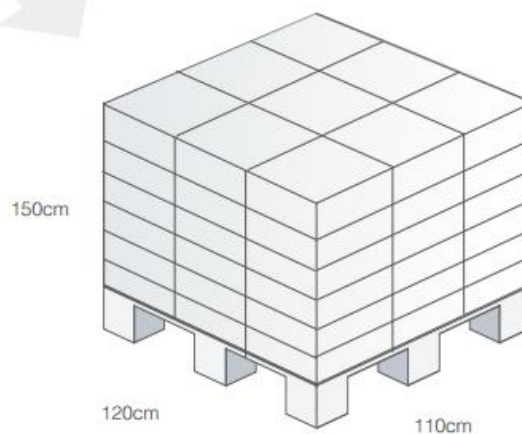



7. Application Note

Antenna performance versus cable length is shown below.

7.1 Return Loss

7.1.1 In free space

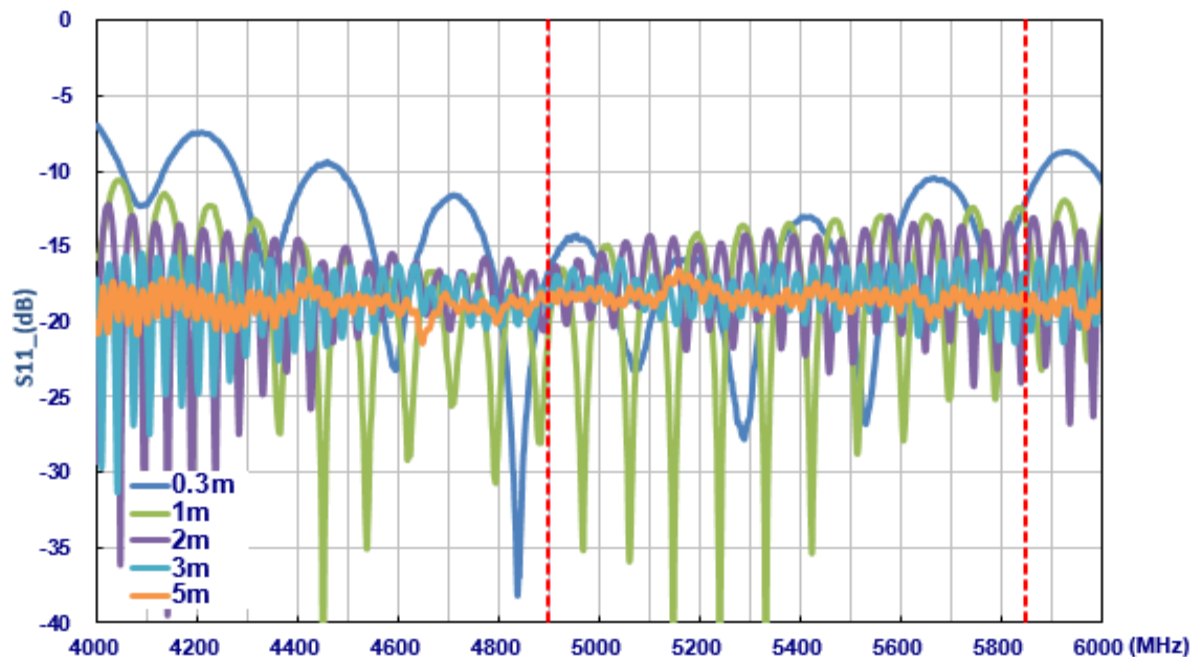

7.1.2 On Glass

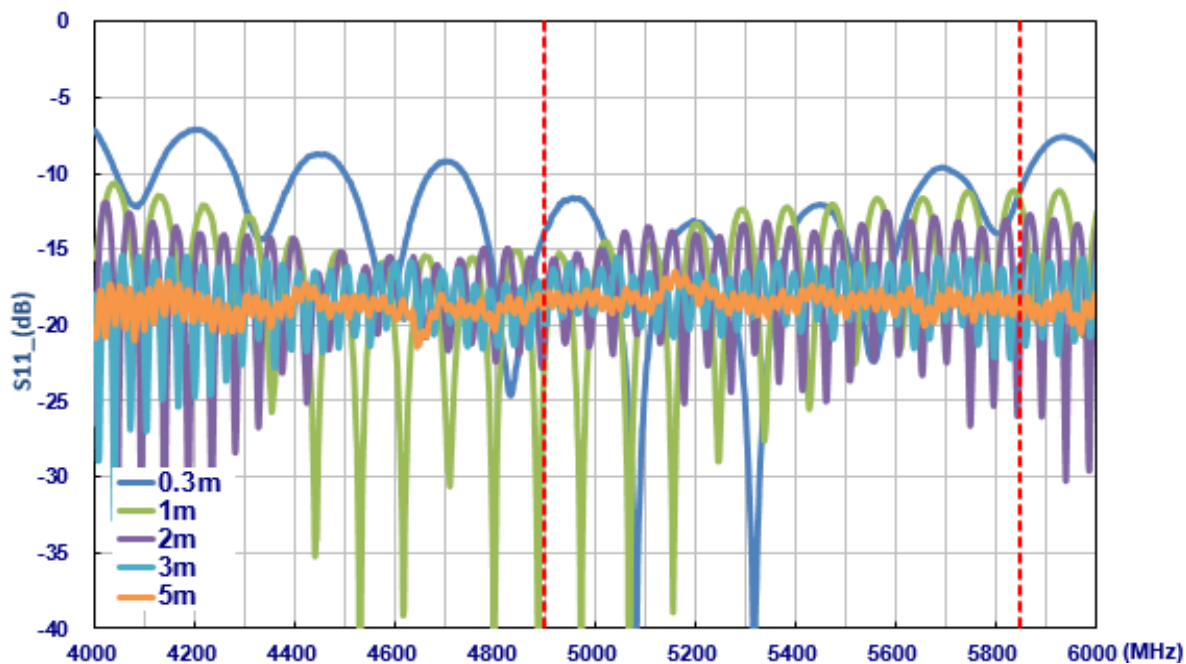



7.1.3 On 2mm ABS

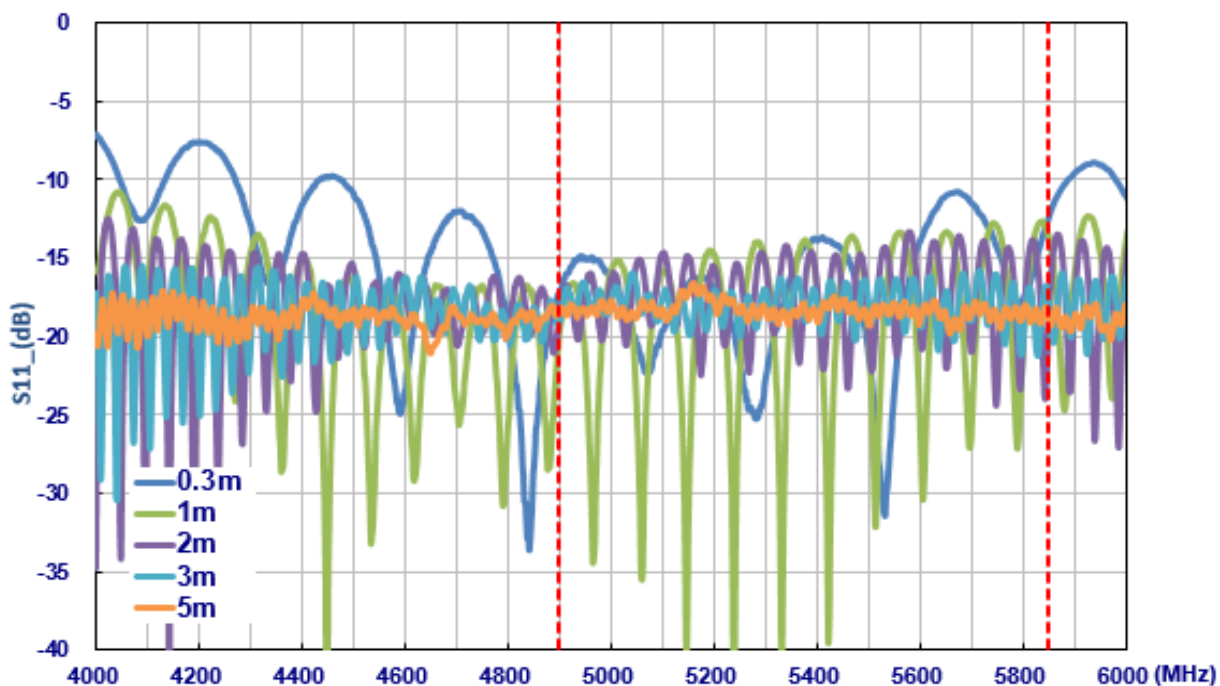

7.2 Efficiency

7.2.1 In free space

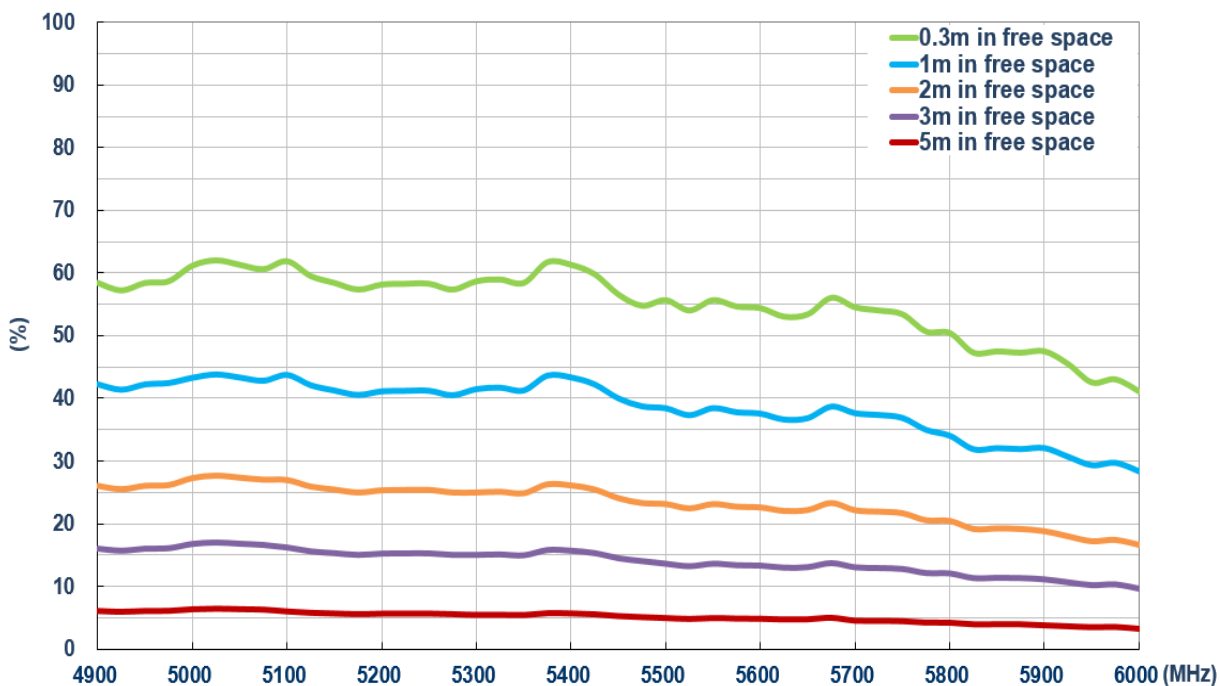



7.2.2 On Glass

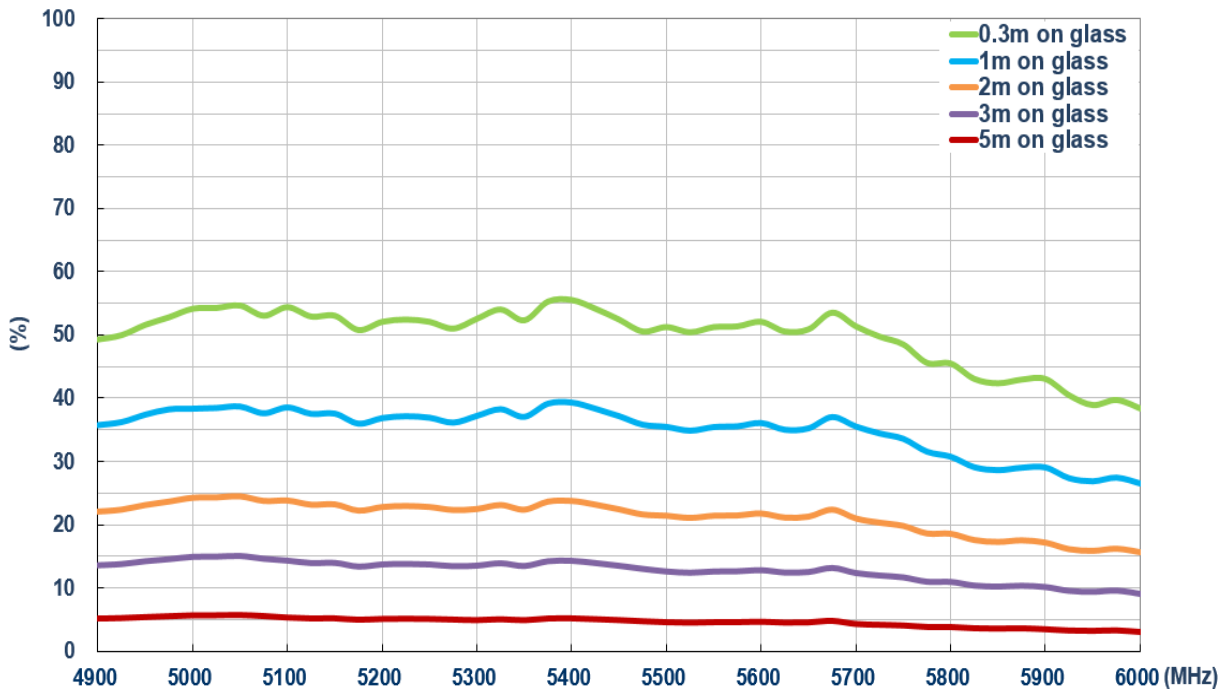

7.2.3 On 2mm ABS

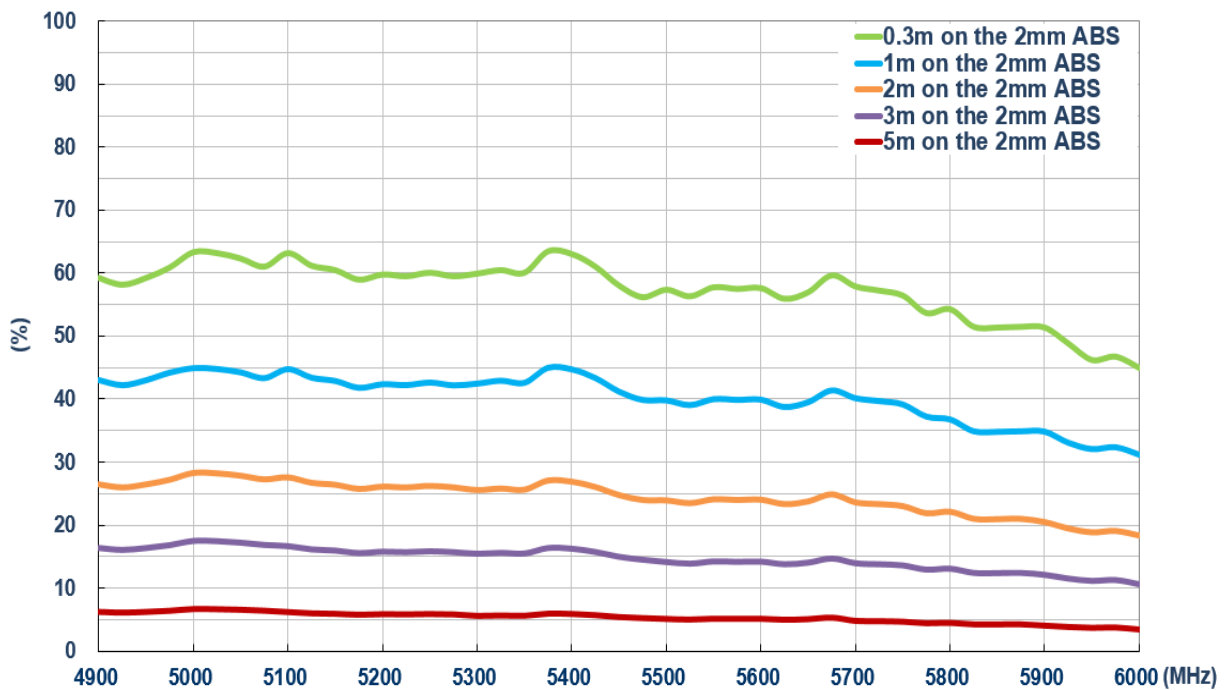



7.3 Peak Gain

7.3.1 In free space

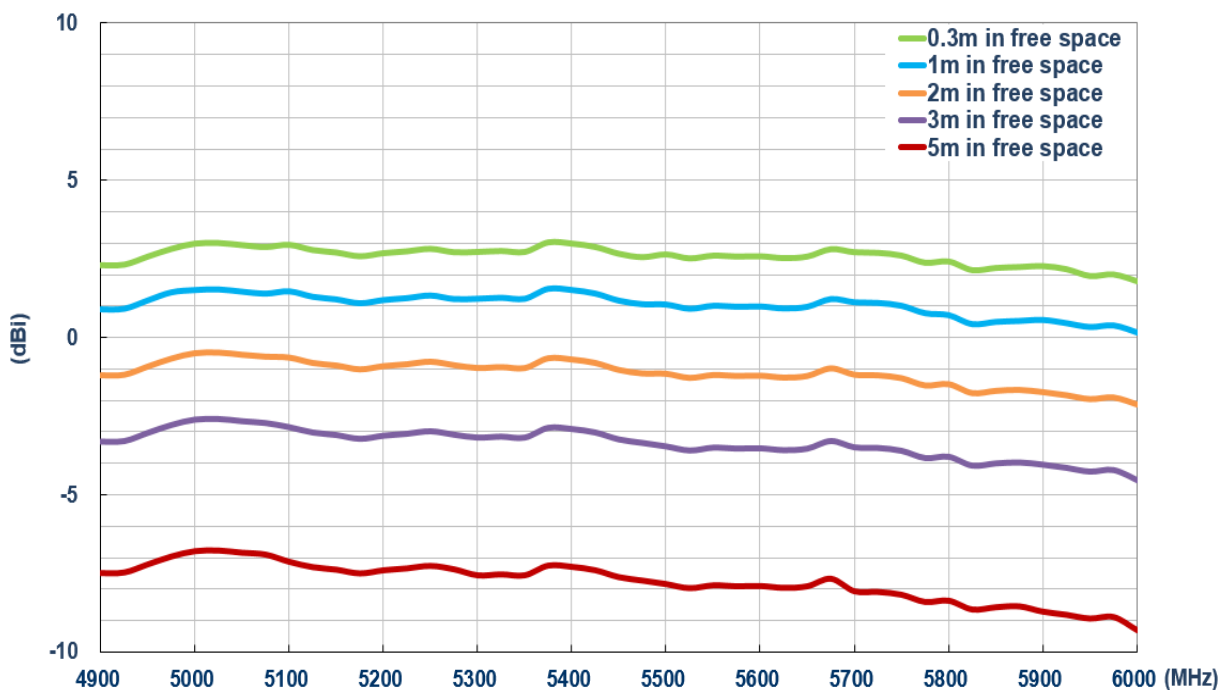

7.3.2 On Glass

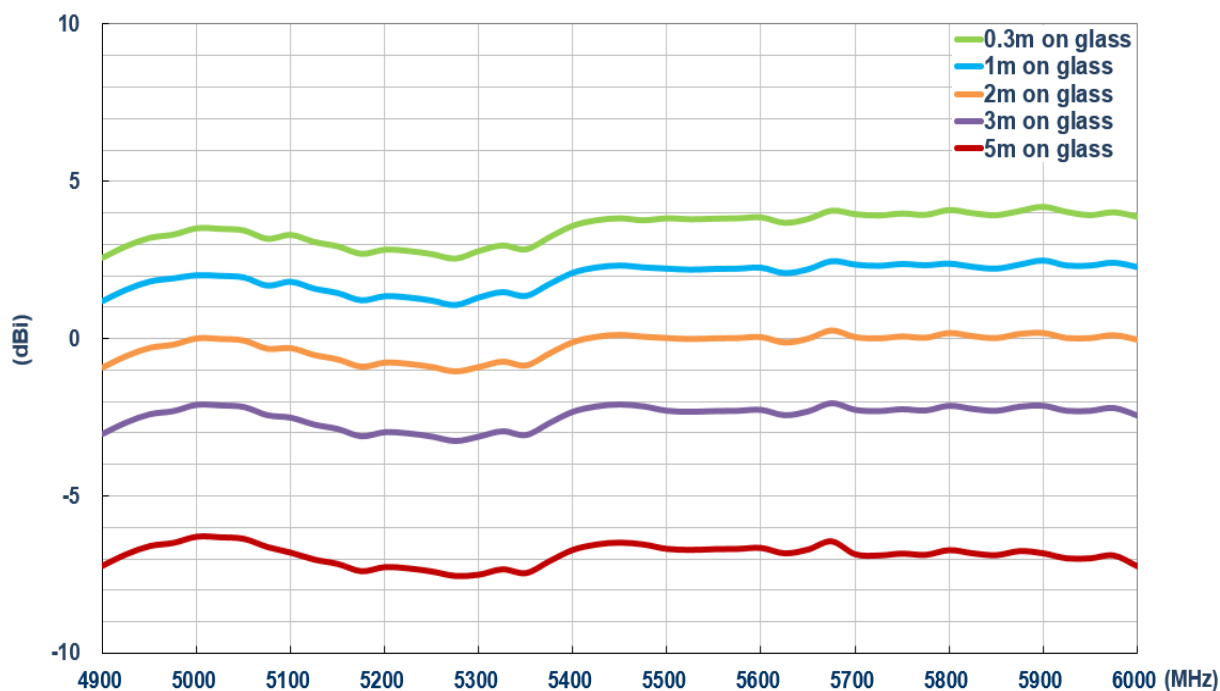



7.3.3 On 2mm ABS

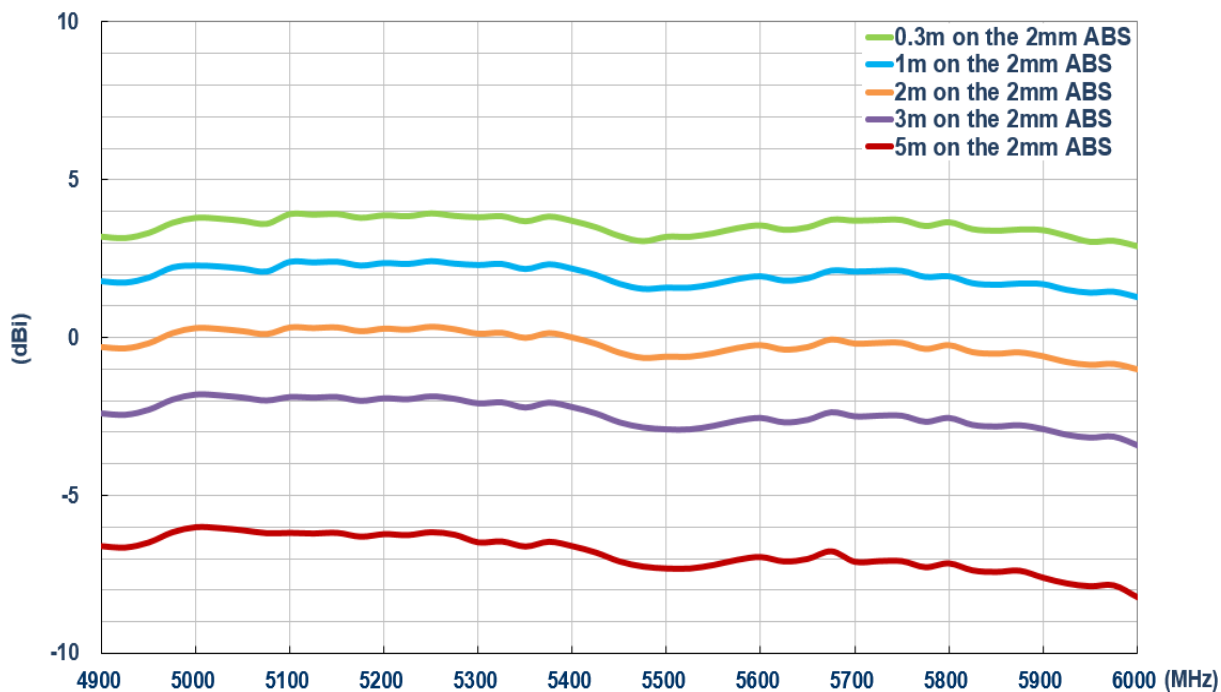

7.4 Average Gain

7.4.1 In free space

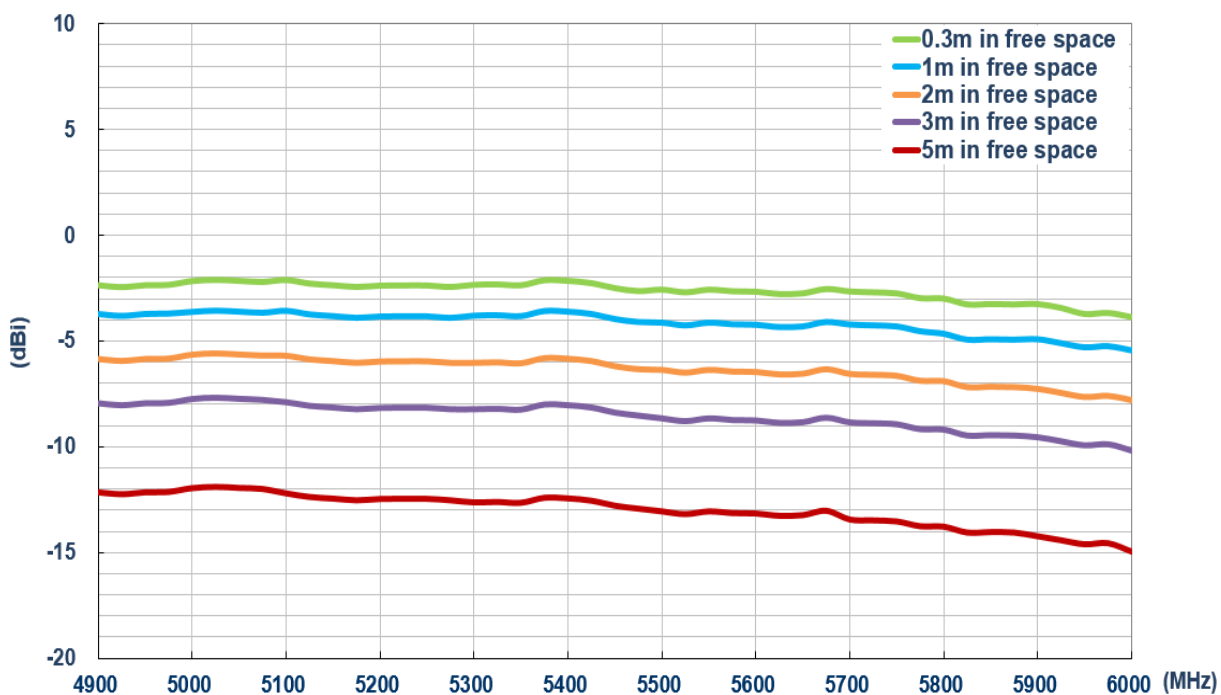



7.4.2 On Glass

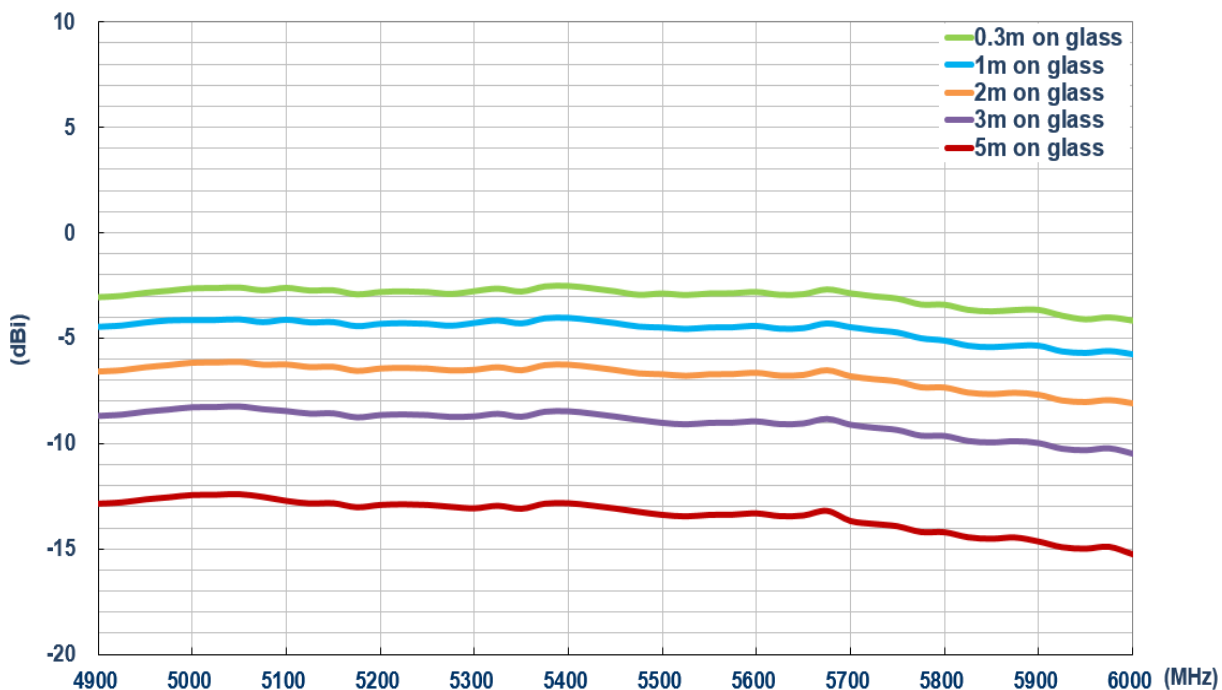

7.4.3 On 2mm ABS

