



# TAOGLAS®



# Datasheet

## Terrablast 25mm Patch Antenna

**Part No:**

WTSP.2400.25.4.A.40

**Description:**

Terrablast 25\*25\*4mm 2.4GHz Pin-Mount Patch Antenna

**Features:**

Low profile – 4mm Height

Pin Type Terrablast Patch Antenna

5.6g Ultra-Lightweight

Peak Gain: 4.9dBi

Efficiency: >60%

Dimensions 25mm x 25mm x 4mm

Ultra Impact Resistant

Right Hand Circularly Polarized

Manufactured and Tested in an TS16949 Certified Facility

RoHS & REACH compliant

1. Introduction	3
2. Specifications	4
3. Antenna Characteristics	5
4. Radiation Patterns	8
5. Mechanical Drawing	10
6. Footprint	11
7. Soldering Method Recommendation	12
8. Packaging	13
<hr/>	
Changelog	14

Taoglas makes no warranties based on the accuracy or completeness of the contents of this document and reserves the right to make changes to specifications and product descriptions at any time without notice. Taoglas reserves all rights to this document and the information contained herein. Reproduction, use or disclosure to third parties without express permission is strictly prohibited.



## 1. Introduction



This Terrablast WTSP.2400 2.4GHz Patch Antenna is a revolutionary antenna developed to meet the needs of UAV and Automotive industries. The right-hand circular polarized design is useful for constantly moving mobile applications where the orientation to the transmitter or receiver changes, ensuring a drop of only approx. 3dB from maximum performance compared to potential drops of 60dB or more if using a linear polarized solution. This substantially increases the reliability of the wireless connection. This patent pending antenna uses a new class of Taoglas polymer dielectric material which makes it more than 30% lighter than traditional ceramic antenna technologies.

Compared to using a traditional ceramic patch antenna of the same size, this Terrablast patch antenna weighs just 5.6g compared to an equivalent ceramic patch of 8.5g. The Terrablast material has ultra-impact resistant characteristics designed to withstand drops, falls and impacts making it ideal for applications such as UAV's, where the antenna's mechanical robustness following potential impacts is critical.

This antenna works well without modifications in most environments but can be tuned and further optimized to different ground-planes and enclosures if required. Custom antenna modifications, such as pin length modifications, are subject to possible NRE and minimum order quantity.

All Terrablast antennas undergo rigorous temperature, vibration and impact tests and exceed the highest ISO16750 standards for Road Vehicles—Environmental Conditions and Electrical testing for Electrical and Electronic equipment. Note the antenna is not suitable for SMD reflow processes. Recommendations for soldering are in Section 7.

For support to test and integrate Taoglas Terrablast technology please contact your regional Taoglas customer support team.

## 2. Specifications

Electrical	
Frequency	2400-2500MHz
Efficiency	62.07%
Average Gain	-2.07dB
Peak Gain	4.93dBi
Axial Ratio	~ 4 @ Zenith
Polarization	RHCP
Impedance	50 ohms
Mechanical	
Patch Dimension	25mm x 25mm x 4mm
Pin Diameter	0.9mm
Pin Length	1.6mm
Weight	5.6g
Environmental	
Storage Temperature	-40°C to 85°C
Operation Temperature	-40°C to 85°C
Humidity	Non-Condensing 65°C 95% RH
Reliability Test	
Low Temperature	-40°C, 24hrs
High Temperature	+85°C, 48hrs
Temperature Cycling	ISO16750 standard, total 240hrs
Temperature Step	ISO16750 standard, total 300mins
Drop Test	12m passed
Shock	10 shocks/ axis, 6 faces
Vibration	ISO16750 standard, 8 hours / axis
Pin pull force	>5kg-f

\* Antenna properties were measured with the antenna mounted on 70\*70mm Ground Plane

### 3. Antenna Characteristics

#### 3.1 Return Loss

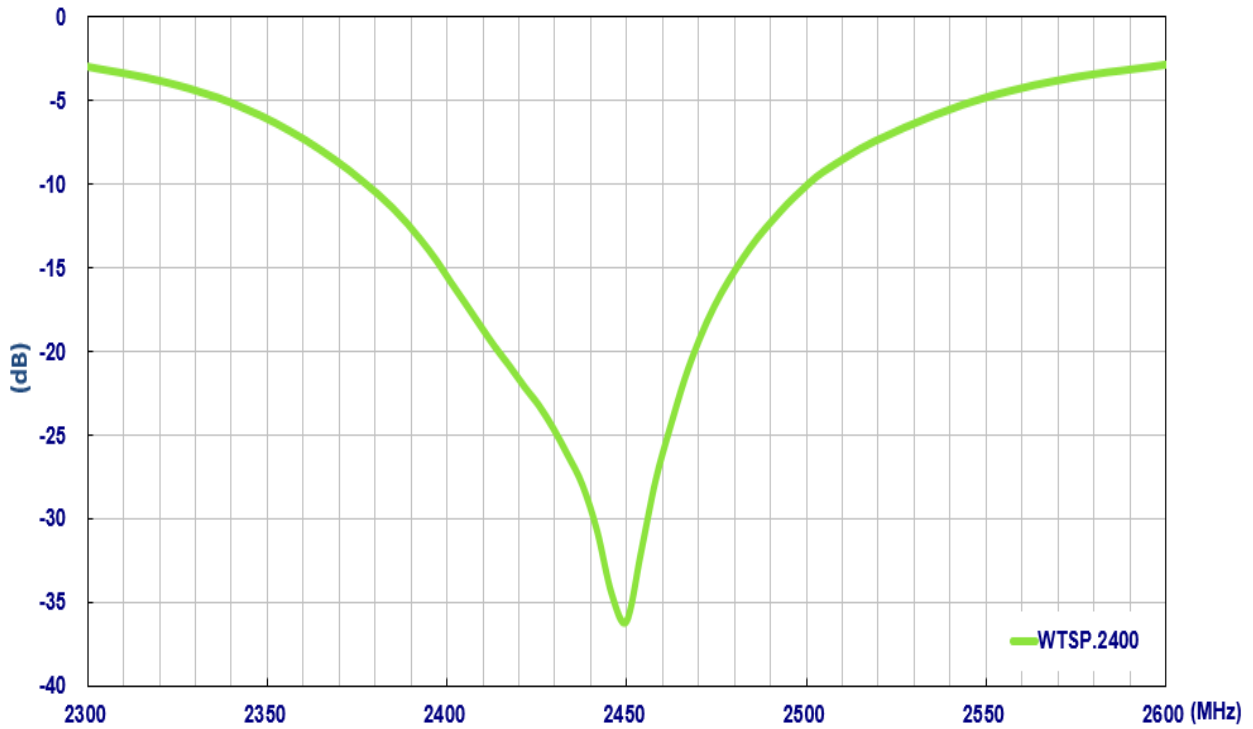

#### 3.2 Efficiency

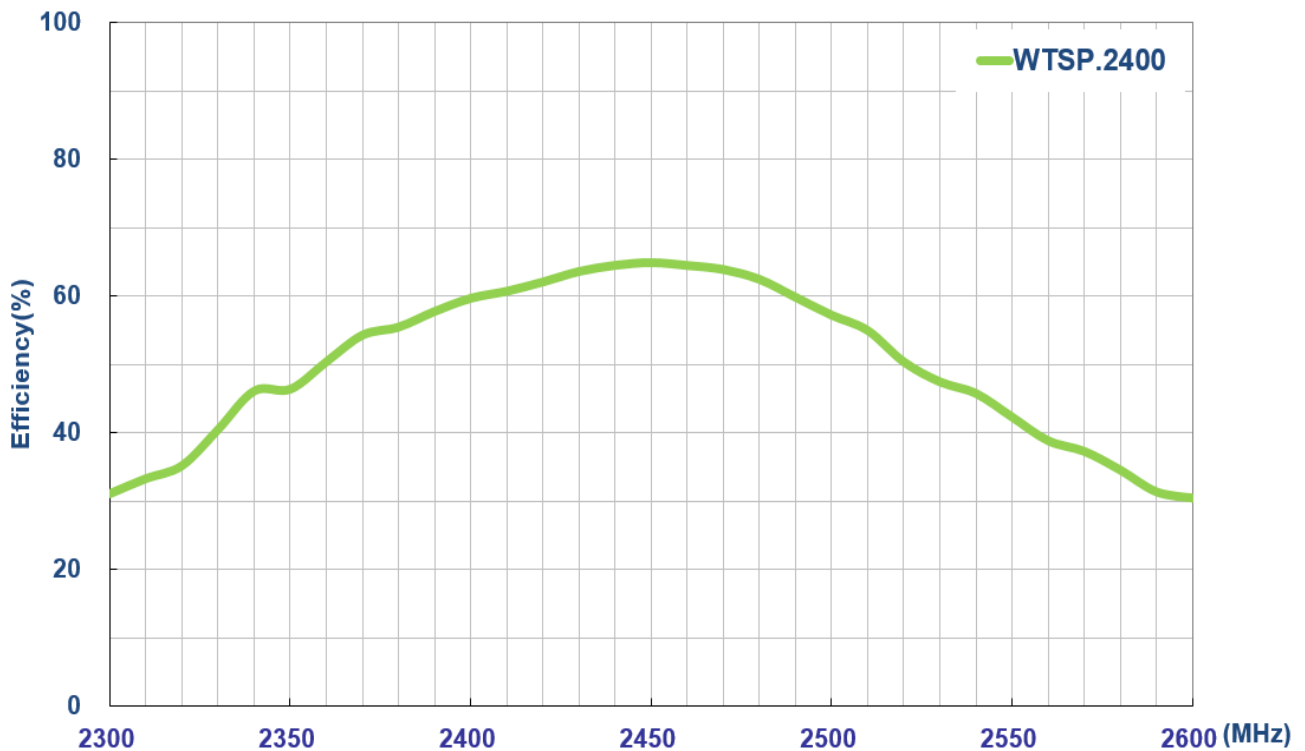

### 3.3 Average Gain

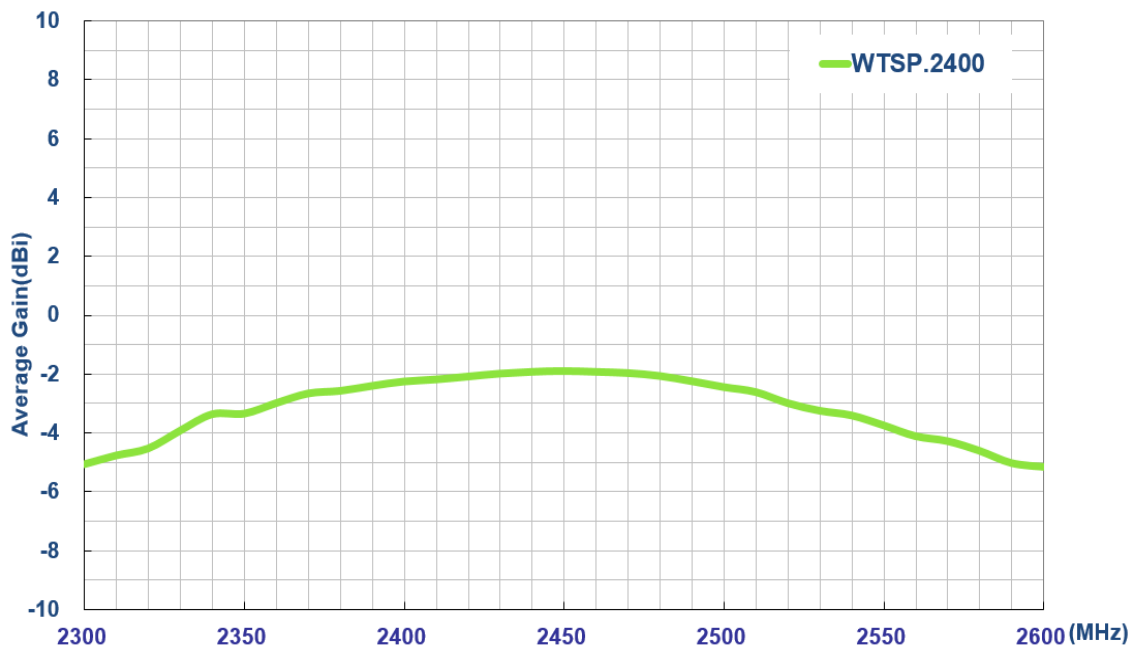

### 3.4 Peak Gain

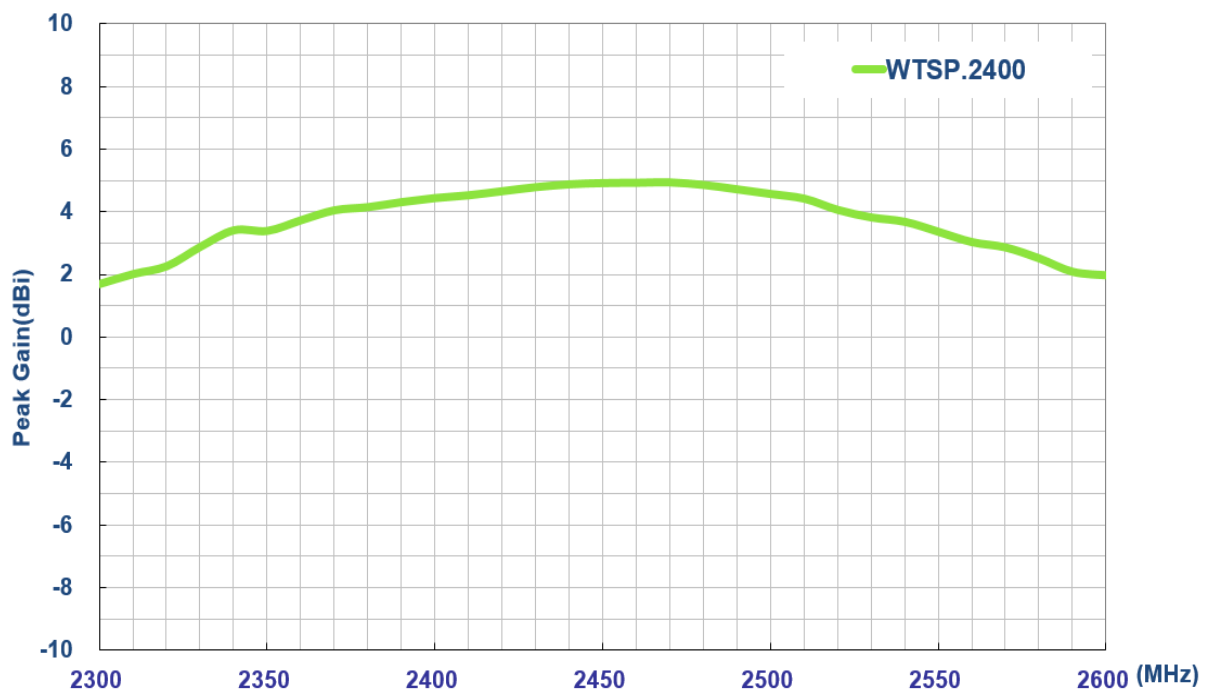

### 3.5 Axial Ratio

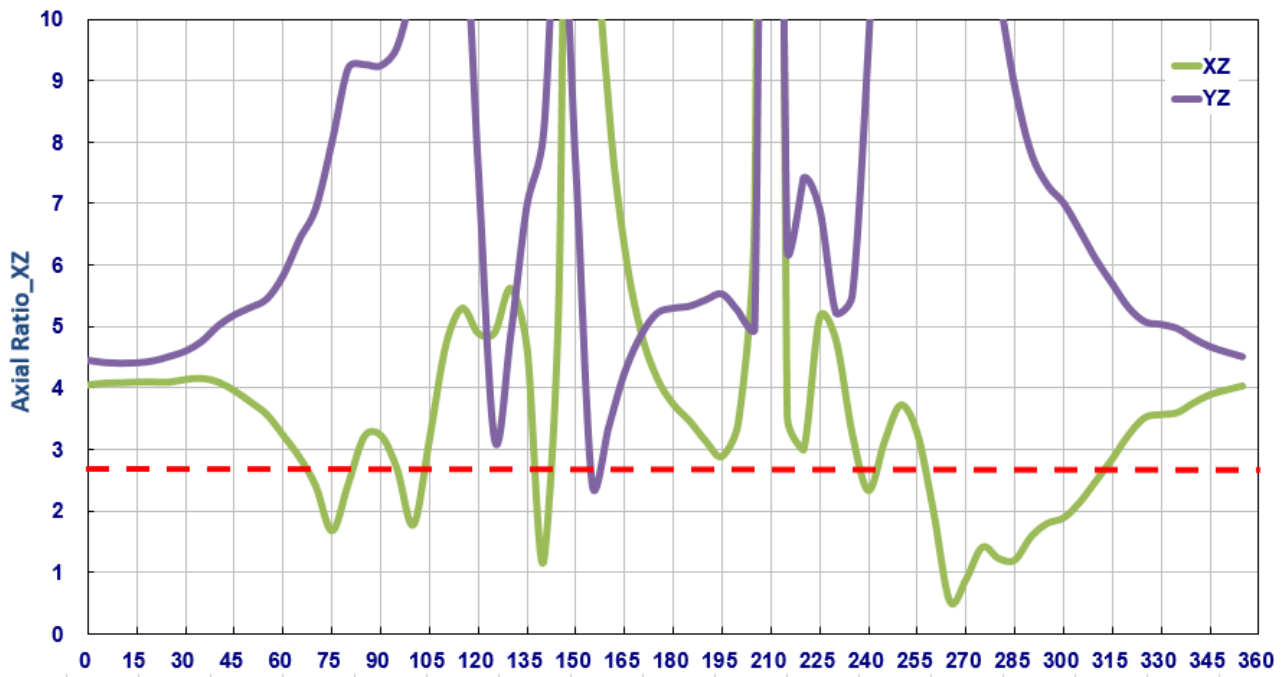

## 4. Radiation Patterns

### 4.1 Test Setup



Tested on a 70x70mm ground plane



## 4.2 2D Radiation Patterns

XY Plane

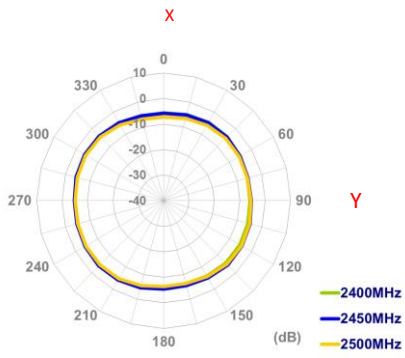

XZ Plane

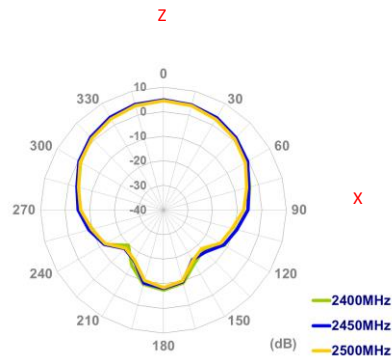

YZ Plane

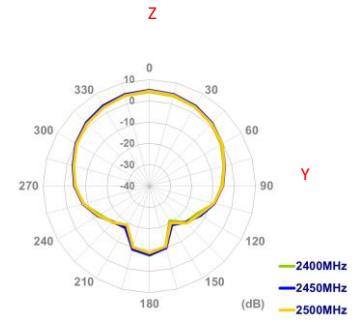

# 5. Mechanical Drawing (Units: mm)

Front View

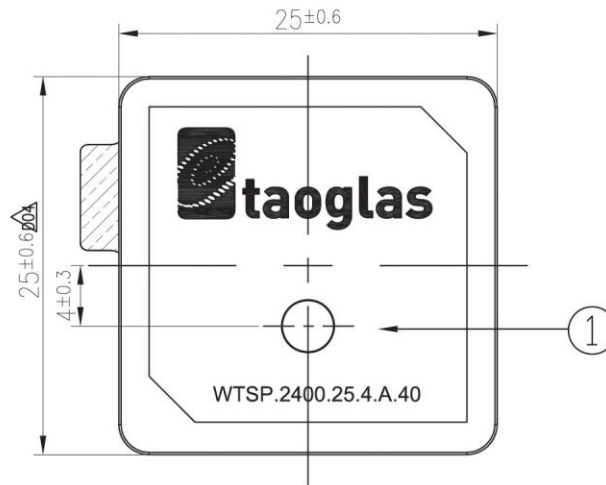

Side View

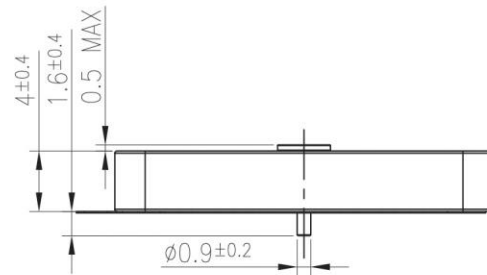

Back View

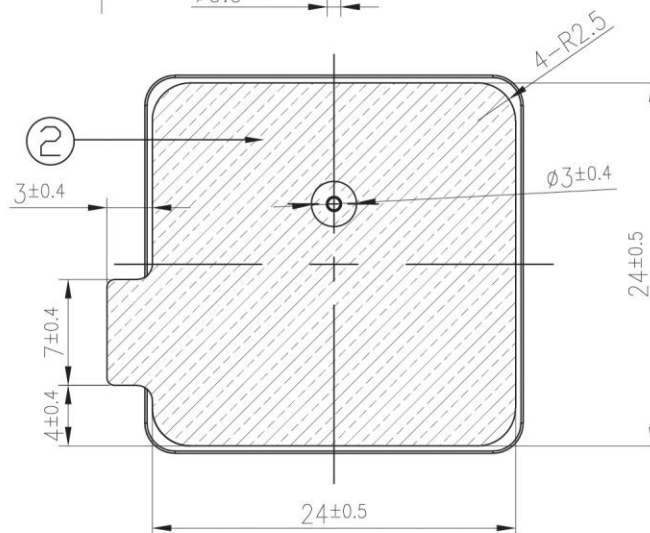

NOTES:

1. Double sided adhesive area. 

	Name	Material	Finish	QTY
1	WTSP.2400 Patch	Terrablast	Clear	1
2	Double Sided Adhesive	NITTO 5015	White Liner	1

## 6. Footprint

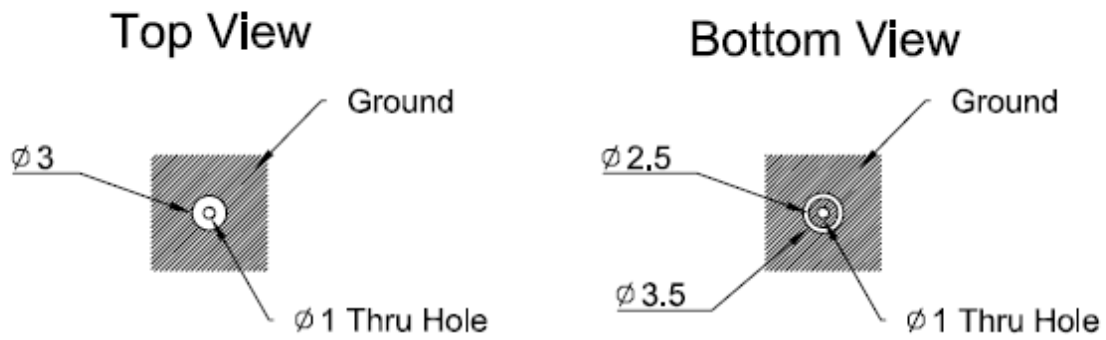

Tolerance: +/- 0,20  
Unit:mm

## 7. Soldering Method Recommendation

### 7.1 Manual Hand Soldering

Soldering Temperature: 360-380°C  
Soldering Duration: 3~4 seconds

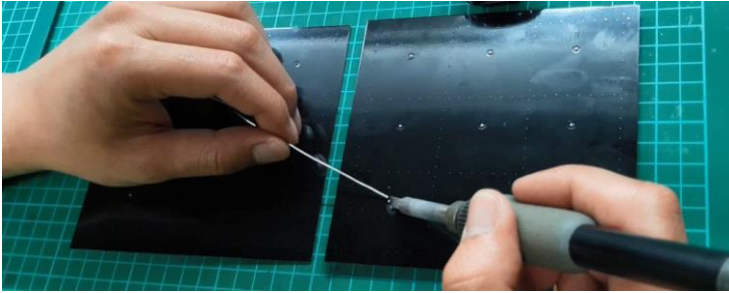

### 7.2 Automated Ferrochrome Soldering Machine

Soldering Temperature: 360-380°C  
Soldering Duration: 3~4 seconds

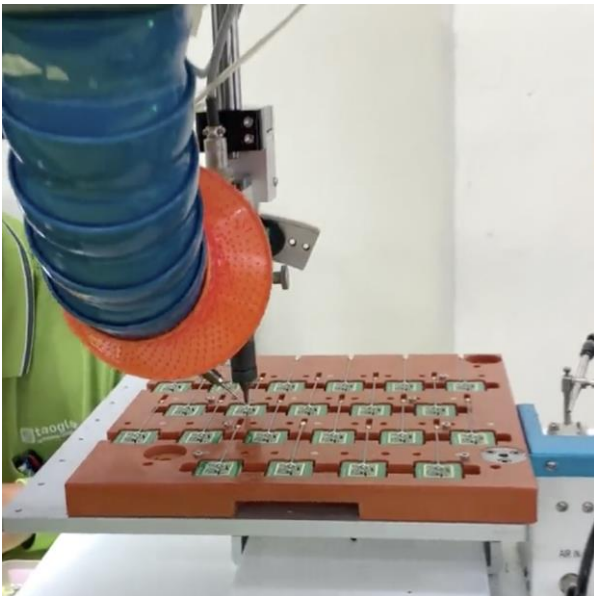

*Please note that this process will require a one-time fixture to be made for each PCB design, Example as per image above.*

## 8. Packaging

50 pcs WTSP.2400.25.4.40 per tray  
 Tray Dimensions - 260\*150\*30mm  
 Weight - 320g

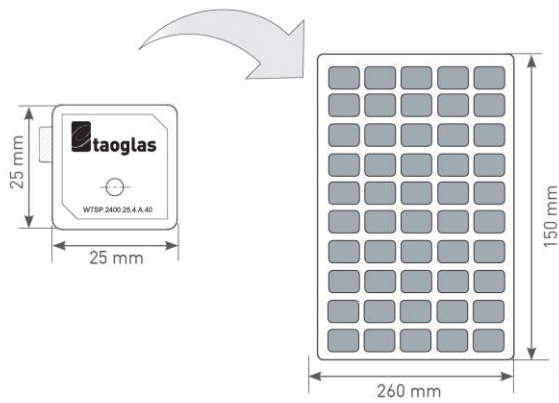

4 trays / 200 pcs WTSP.2400.25.4.40 per box  
 Box Dimensions - 261\*152\*118mm  
 Weight - 1.45kg

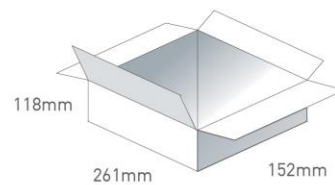

800 pcs WTSP.2400.25.4.40 per Carton  
 Carton Dimensions - 330\*280\*270mm  
 Weight - 6.2kg

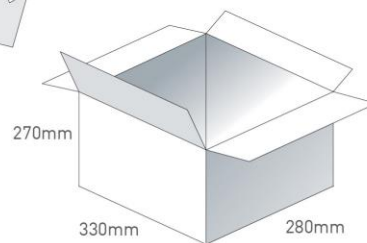

Pallet Dimensions 1200\*1000\*1280mm  
 48 Cartons per Pallet  
 12 Cartons per layer  
 4 Layers

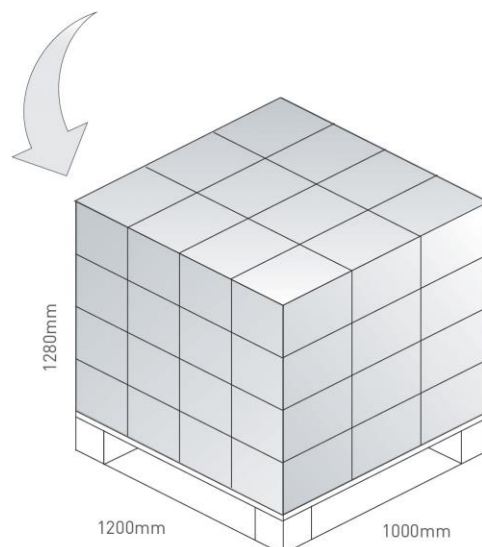

Changelog for the datasheet

**SPE-18-8-016-B - WTSP.2400.25.4.A.40**

**Revision: B (Current Version)**

Date:	2020-12-04
Changes:	Amending the soldering instructions and updating the datasheet to new format.
Changes Made by:	Gary West

**Previous Revisions**

**Revision: A**

Date:	2017-03-08
Changes:	First Release
Changes Made by:	AW