



PulseR

Ruggedized Solutions



CONTACT US



311 SINCLAIR
ROAD BRISTOL, PA
19007- 6812



Tel: 215.781.6400
Fax: 215.781.6403



www.pulseruggedized.com



PulseR, LLC. (formerly Pulse Electronics Military & Aerospace / Specialty Products) is a World-Class Manufacturer with 70 years' experience supplying catalog and custom magnetic components to the military, commercial aerospace, manned, unmanned space, high-reliability industrial, medical, transportation and power-grid infrastructure markets around the world. The company was originally founded as Technitrol in 1947 and produces parts that are D.S.C.C. qualified products listed for MIL-PRF-27, MIL-PRF-21038, MIL-PRF-83531 & MIL-PRF-83532 magnetic devices.

PulseR's experienced engineering teams, offer cutting-edge technical solutions and manufacturing expertise which provide comprehensive production at AS9100D certified facilities located both domestically and off shore. PulseR offers complete design support and qualification testing services to meet your demanding requirements.

Our Mission Statement

- To serve Defense, Aerospace, Space and High-Rel industry customers with the highest level of service focusing on a relationship with mutual benefits.
- To design and manufacture magnetic solutions exceeding customers' satisfaction in terms of quality, reliability and delivery.
- To be competitive while remaining a world class source or speciality solutions.

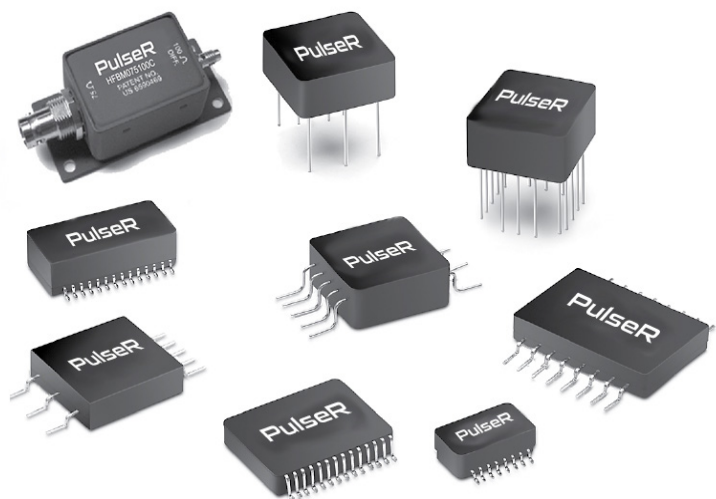

Table of Contents

PulseR Signal Products.....	Pages 3- 10
Copperhead™ Series Transceiver Line Interface Modules (Active).....	Page 3
Copperhead™ High Speed Dual Transformers (Dual Passive).....	Page 3
Copperhead™ High Speed Single Transformers (Single Passive).....	Page 3
IEEE 1394B Firewire Transceiver Line.....	Page 4
High-Frequency Balun Adaptors	Page 4
Ethernet/AFDX (10/100).....	Page 5
Ethernet/AFDX (10/100/1000).....	Page 6
High Isolation Ethernet (10KV).....	Page 7
High-Speed Data Transformer.....	Page 8
MIL-STD-1553 Interface Transformers (Non-QPL).....	Page 9
MIL-STD-1553 Interface Transformers (Low Profile and Stacked).....	Page 10
MIL-STD-1553 Interface Transformers (Low Profile Miniature Series).....	Page 10
QPL Series - Qualified to MIL-PRF-21038/27.....	Page 10
PulseR Power Products.....	Pages 11-17
Toroid Power Inductors (SLED Series).....	Page 11
SMT Common Mode Chokes (SLIC Series).....	Page 11
SMT Power Inductors (SLIC, HCCI-80) Series.....	Page 12
SMT Power Inductors (Toroid, SLED Series).....	Page 12
SMT Power Inductors (Toroid, POGO Series).....	Page 12
SMT Common Mode Inductors (POGO Series)	Page 13
SMT Power Inductors (Shielded Drum Core).....	Page 13
SMT Current Sense Transformer	Page 15
High Frequency Planars Power Inductors	Page 15
SMT Current Sense Transformers.....	Page 17
Gate Drive Transformers	Page 17
Additional Products.....	Page 18
Custom Capabilities & Designer Worksheets	Page 19-20

PulseR LLC. offers catalog and custom designs including a comprehensive range of high performance solutions and packaging options for QPL and non-QPL MIL-STD-1553 interface transformers, Data Bus Couplers Baluns, Wideband Transformers and Delay Lines. PulseR offers custom and catalog magnetics ruggedized for Military, MIL-PRF-21038, MIL-STD-981 & High Reliability applications. PulseR has a full line of high speed transformers supporting Ethernet IEEE802.x, AFDX systems, SMPTE Serial Video, Fibre Channel and IEEE1394B applications. A unique line of Line Interface Transceivers supports a wide range of cable impedances and data rates up to 2.125 Gbps. Parts have found use on Fighter Jets and Space program. PulseR continues to offer tin/lead termination finishes for Military, Space and Aerospace applications requiring the highest reliability. Parts can also be purchased with pure tin lead finishes where RoHS and REACH compliance are required. In addition to providing a catalog of Ruggedized products for Military & Aerospace usage more than 50% of business is for customized parts to customer requirements. PulseR can provide custom design services as well as perform specialized screening and qualification testing.

COPPERHEAD™ SERIES TRANSCEIVER LINE INTERFACE MODULES - ACTIVE

High Speed Data and Communications over 100+ Meters of Copper

- ! Military temperature range -55°C to +125°C
- ! Low transmit/receive jitter
- ! Low power dissipation; 450 mW typical
- ! ECL or CML logic interface
- ! 1500V Isolation Voltage
- ! Surface mount – pick-and-place compatible
- ! Withstands infrared and vapor phase soldering 225°C MAX Temperature

Ordering Information

TM	531	D	S	A	1	(XX)
						(XX) – Customer product designator
					blank	– No transmit driver
					1	– 1100 mV output transmit driver and military temperature range
					2	– 1100 mV output transmit driver and industrial temperature range
					5	– Active cable equalizer circuit
				A		– 5.00 Volt
				B		– 3.30 Volt
			S			– Impedance matched for STP and Twinax (150 Ω)
			U			– Impedance matched for Unshielded Twisted Pair (100 Ω)
			V			– Impedance matched for Video and Mini-Coax (75 Ω)
			C			– Impedance matched for Coax (50 Ω)
			D			– Gull wing, DIP, 28-pin package: 0.800”L x 0.400”W x 0.200”H
			F			– Gull wing, flatpack, 28-pin package: 0.760”L x 0.610”W x 0.125”H
			H			– Gull wing, half-DIP, 16-pin package: 0.500”L x 0.300”W x 0.250”H (16-pin package is only available on passive units.)
					133	– 132.8125 Mbaud version, 1/8 Speed Fibre Channel/ATM
					266	– 265.625 Mbaud version, 1/4 Speed Fibre Channel
					531	– 531.25 Mbaud version, 1/2 Speed Fibre Channel
					1062	– 1.0625 Gbaud version, Full Speed Fibre Channel
					1250	– 1.250 Gbaud version, Gigabit Ethernet (both short haul and long haul)
					1485	– 1.485 Gbaud version, SMPTE
					2125	– 2.125 Gbaud Double Speed Fiber Channel

COPPERHEAD™ HIGH SPEED DUAL TRANSFORMERS -PASSIVE

Part Number	Package L/W/H (in.)	Turns Ratio (±5%)	Primary Inductance (μH MIN)**	Rise Time (ps: MAX @20-80%)	DC Resistance (Ω MAX)	Hipot (Vrms MIN)	Insertion Loss (dB MAX)	Application Nominal Bit Rate (Mbps)	Datasheet
T-330SCT	.500/.435/.180	1CT:1CT	26.0	350	0.2	1500	-1.5 (15-165 MHz)	265.6 (quarter speed)	M105
T-531SCT	.500/.375/.235	1CT:1CT	7.5	325	0.2	1500	-2.0 (50-265 MHz)	531 (half speed)	M105
T-1062SCT	.500/.435/.180	1CT:1CT	3.75	280	0.2	1500	-2.0 (100-531 MHz)	1062.50 (full speed)	M105
T-1250SCT	.500/.435/.180	1CT:1CT	3.75	280	0.2	1500	-2.0 (125-650MHz)	1,250 (Gigabit Ethernet)	M105
T-1485SCT	.500/.435/.180	1CT:1CT	3.75	280	0.2	1500	-2.0	1,485 (SMPTE)	M105
T-3200SCT	.500/.375/.235	1CT:1CT	0.70	280	0.2	1500	-4.5 (500 -1600MHz)	3200	M105

COPPERHEAD™ HIGH SPEED SINGLE TRANSFORMERS- PASSIVE

Part Number	Package L/W/H (in.)	Turns Ratio (±5%)	Primary Inductance (μH MIN)**	Rise Time (ps: MAX @20-80%)	DC Resistance (Ω MAX)	Hipot (Vrms MIN)	Insertion Loss (dB MAX)	Application Nominal Bit Rate (Mbps)	Datasheet
T-330ACT	.230/.265/.215	1CT:1CT	26	350	0.2	1500	-1.5 (15-165 MHz)	265.5 (quarter speed)	M456
T-531ACT	.230/.265/.215	1CT:1CT	7.5	325	0.2	1500	-2.0 (100-265 MHz)	531 (half speed)	M131
T-1062ACT	.230/.265/.215	1CT:1CT	3.75	280	0.2	1500	-2.0 (100-531 MHz)	1,062.5 (full speed)	M131
T-1250ACT	.230/.265/.215	1CT:1CT	3.75	280	0.2	1500	-2.0 (200-620 MHz)	1,250 (Gigabit Ethernet)	M131
T-1485ACT	.230/.265/.215	1CT:1CT	3.75	280	0.2	1500	-2.0 (200-742.5 MHz)	1,485 (SMPTE)	M131

1. Web: <http://www.pulseruggedized.com> home page, click on "PRODUCT FINDER" and enter the part number.
2. Dual Transformers designed specifically for Point-to-Point Communication using STP, QUADRAX or TWINAX cable (comparable with 50,75,100 & 150Ω cable)
3. Applications: Fibre Channel, Gigabit Ethernet, SONET, HDTV, IEEE 1394B, SMPTE.
4. Parts can be ordered RoHS by adding a suffix "NL" to the part number (i.e. T-330SCTNL).
5. Tape&Reel packaging is available by adding a suffix "T" to the part number (i.e. T-330SCTT)

** Measured @ 1.0Vrms, 100KHz

IEEE 1394B FIREWIRE TRANSCIVER LINE INTERFACE MODULES

Part Number	Transmitter/Receiver Data Rate		Transmitter Differential Signal Level - Vout (mV)			Total Power Dissipation (mW) TYP	Receive Turns Ratio TYP	Receive Primary Inductance-Lm (uH) MIN	Receive Insertion Loss (dB) (dBMax)	Transmit/ Receive Return Loss (dBMIN)	Package L/W/H (in.)	Data Sheet	IEEE 1394B Speed
	MIN	MA	MIN	TYP	MAX								
	TM1062TXDUA	246	1062	1200	1300								
TM1062TXHUA	246	1062	1200	1300	1500	232	1:1	4.5	-2	-12	.510 / .300 / .140	M103	S200-S800
TM1062TX3DUA	246	1062	1200	1300	1500	700	1:1	4.5	-2	-12	.800 / .400 / .185	M103	S200-S800
TM125TXHUA	98	246	1200	1300	1500	232	1:1	40	-2	-12	.510 / .300 / .140	M186	S100-S200
TM1062DUXB	246	1062	1200	1300	1500	232	1:1	4.5	-2	-12	.800 / .400 / .200	M186	S200-S800
TM1062HUXB	246	1062	1200	1300	1500	232	1:1	4.5	-2	-12	.510 / .300 / .140	M186	S200-S800
TM1062DU3XB	246	1062	1200	1300	1500	232	1:1	4.5	-2	-12	.800 / .400 / .200	M186	S200-S800
TM125TXHUA	98	246	1200	1300	1500	232	1:1	40	-2	-12	.510 / .300 / .140	M186	S100-S200

Notes: Parts listed on datasheet M103 and M306 are manufactured in the United States. Datasheet M186 contains equivalent parts manufactured in China.

SMPTE VIDEO BALUN ADAPTORS

Part Number	Unbalanced (Ω)	Impedance Balanced (Ω)	Insertion Loss dB MAX 1.485 Gbps	Jitter Dj pSec. MAX 1.485 Gbps	Datasheet	Bracket
HFB075100A	75	100	-2.0	110.0	M146	NO
HFB075100B	75	100	-2.0	110.0	M146	NO
HFB075150A	75	150	-2.0	110.0	M146	NO
HFB075150B	75	150	-2.0	110.0	M146	NO
HFBLO75100A	75	100	-2.0	110.0	M146	YES
HFBLO75100B	75	100	-2.0	110.0	M146	YES
HFBLO75150A	75	150	-2.0	110.0	M146	YES
HFBLO75150B	75	150	-2.0	110.0	M146	YES
HFBM075100B	75	150	-2.0	110.0	M147	YES
HFBM075100C*	75	100	-2.0	110.0	M147	YES
HFBM075100S*	75	100	-2.0	110.0	M305	YES
HFBM075100L*	75	100	-2.0	110.0	M265	YES
HFB075100D	75	100	-2.0	110.0	M283	YES

Transform 100Ω or 150Ω balanced differential signal to 75Ω, grounded, unbalanced signal. Designed for SMPTE-292M. HDTV application at 1.485Gbps data rate. Designed for M21038 Environmental, requirements.

75Ω Connectors: HFBM075100C - Triax, Trompeter BJ770
75Ω Connectors: HFBM075100S- BNC

SMPTE VIDEO BALUN ADAPTORS 3G

Part Number	Unbalanced (Ω)	Impedance Balanced (Ω)	Insertion Loss dB MAX 2.973 Gbps	Jitter Dj pSec. MAX 2.973 Gbps, PN 7	Bracket	Datasheet
HFB3G075100A	75	100	-6.5	65.0	NO	M416
HFB3G075100B	75	100	-6.5	65.0	NO	M416
HFB3GL075100A	75	100	-6.5	65.0	YES	M416
HFB3GL075100B	75	100	-6.5	65.0	YES	M416
HFB3G075150A	75	150	-6.5	65.0	NO	M416
HFB3G075150B	75	150	-6.5	65.0	NO	M416
HFB3GL075150A	75	150	-6.5	65.0	YES	M416
HFB3GL075150B	75	150	-6.5	65.0	YES	M416

Transform 100Ω to 150Ω differential signal to 75Ω grounded unbalanced signal. Designed for SMPTE-424M/425M, 2,973Gbps.

INSTRUMENTATION BALUN ADAPTERS

Part Number	Impedance Unbalanced (Ω)	Impedance Balanced (Ω) 1.485Gbps	Insertion Loss dB MAX 1.485Gbps	Return Loss (dB MIN) 1.0MHz -1.2 GHz	Datasheet
HFB050150	50	150	-2	15	M100
HFB050100	50	100	-2	15	M100
HFB050078	50	78	-2	15	M100

Transformers 150Ω, 100Ω, or 78Ω, balanced, differential signal, to 50Ω signal ended signal. Designed for standard test equipment with SMA connectors. Wide bandwidth -1.0 MHz-1.2GHz.



PULSER ETHERNET/AFDX								
10/100								
Number of Ports	Part Number	Turns Ratio	Configuration-		Style	Package	Data Sheet	
			RX	TX		Size L/W/H (in.)		
Single	100B-1001	1CT:1CT	T,C	T,C,S	t	12-pin SMT	.630/.470/.200	M101
	100B-1001X	1CT:1CT	T,C	T,C,S		12-pin SMT	.630/.470/.200	M101
	100B-1001F	1CT:1CT	T,C	T,C,S	12-pin SMT	.630/.470/.200	M101	
	100B-1001FX	1CT:1CT	T,C	T,C,S	12-pin SMT	.630/.470/.200	M101	
	100B-1003	1CT:1CT	T,C	T,C	16-pin SMT	.500/.265/.235	M101	
	100B-1003X	1CT:1CT	T,C	T,C	16-pin SMT	.500/.265/.235	M101	
	100B-1018	1CT:1CT	T,C	T,C,S	12-pin SMT	.583/.470/.180	M189	
	100B-1018X	1CT:1CT	T,C	T,C,S	12-pin SMT	.583/.470/.180	M189	
	100B-1027	1CT:1CT	T,C	T,C,S	16-pin SMT	1.00/.390/.235	M197	
	100B-1027X	1CT:1CT	T,C	T,C,S	16-pin SMT	1.00/.390/.235	M197	
	100B-1035	1CT:1CT:	T,C	T,C	12-pin SMT	.500/.347/.088	M316	
	100B-1051	1CT:1CT	T,C	T,C	24-pin SMT	.590/.520/.155	M440	
	100B-1054X	1CT:1CT	T,C	T,C	16-pin SMT	.500/.358/.236	M441	
Dual	100B-2002	1CT:1CT	T,C	T,C	24-pin SMT	.518/.595/.241	M110	
	100B-2002X	1CT:1CT	T,C	T,C	24-pin SMT	.518/.595/.241	M110	
	100B-2002F	1CT:1CT	T,C	T,C	24-pin SMT	.518/.595/.241	M110	
	100B-2002FX	1CT:1CT	T,C	T,C	24-pin SMT	.518/.595/.241	M110	
Quad	100B-4005	1CT:1CT	T,C	T,C	40-pin SMT	1.125/.480/.280	M203	
	100B-4005X	1CT:1CT	T,C	T,C	40-pin SMT	1.120/.480/.280	M203	
	100B-4005F	1CT:1CT	T,C	T,C	40-pin SMT	1.125/.480/.280	M203	
	100B-4005FX	1CT:1CT	T,C	T,C	40-pin SMT	1.120/.480/.280	M203	
	100B-4009	1CT:1CT	T,C	T,C	40-pin SMT	1.125/.480/.280	M190	
	100B-4009X	1CT:1CT	T,C	T,C	40-pin SMT	1.125/.480/.280	M190	
	100B-4009F	1CT:1CT	T,C	T,C	40-pin SMT	1.125/.480/.280	M190	
	100B-4009FX	1CT:1CT	T,C	T,C	40-pin SMT	1.125/.480/.280	M190	
	100B-4011	1CT:1CT	T,C	T,C	40-pin SMT	1.125/.480/.280	M151	
	100B-4011X	1CT:1CT	T,C	T,C	40-pin SMT	1.125/.480/.280	M151	
	100B-4011F	1CT:1CT	T,C	T,C	40-pin SMT	1.125/.480/.280	M151	
	100B-4011FX	1CT:1CT	T,C	T,C	40-pin SMT	1.125/.480/.280	M151	
	100B-4018	1CT:1CT	T,C	T,C	40-pin SMT	1.110/.630/.225	M448	
	100B-4019	1CT:1CT	T,C	T,C	40-pin SMT	1.08/.630/.226	M449	
100B-4020	1CT:1CT	C,T,C	C,T,C	40-pin SMT	1.090/.360/.236	M307		

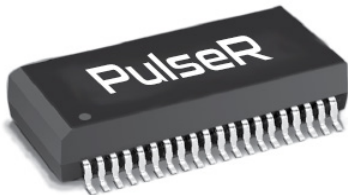
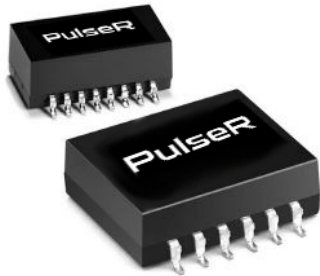
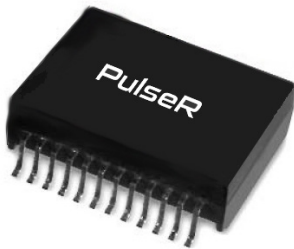

PULSER ETHERNET/AFDX

Number Ports	Part Number	Turns Ratio	10/100/1000/10,000 Configuration		Style	Package Size L/W/H (in.)	Data Sheet
			RX	TX			
SINGLE	1000B-5001	1CT:1CT	T, C, S	T,C,S	24-pin SMT	.695/.635/.230	M1061
	1000B-5001X	1CT:1CT	T, C, S	T,C,S	24-pin SMT	.695/.635/.230	M1061
	1000B-5001F	1CT:1CT	T, C, S	T,C,S	24-pin SMT	.695/.635/.230	M106
	1000B-5001FX	1CT:1CT	T, C, S	T,C,S	24-pin SMT	.695/.635/.230	M106
	1000B-5002	1CT:1CT	T, C	T,C	24-pin SMT	.695/.635/.230	M1061
	1000B-5002X	1CT:1CT	T, C	T,C	24-pin SMT	.695/.635/.230	M1061
	1000B-5002F	1CT:1CT	T, C	T,C	24-pin SMT	.695/.635/.230	M106
	1000B-5002FX	1CT:1CT	T, C	T,C	24-pin SMT	.695/.635/.230	M106
	1000B-5004	1CT:1CT	T,C,S	T,C,S	24-pin SMT	.705/.490/.190	M428
	1000B-5009	1CT:1CT	T	T	24-pin SMT	.600/.430/.340	M160
	1000B-5009X	1CT:1CT	T	T	24-pin SMT	.600/.430/.340	M160
	1000B-5010 (PoE)	1CT:1CT	T,C,S	T,C,S	24-pin SMT	.690/.480/.225	M290
	1000B-5010X (PoE)	1CT:1CT	T,C,S	T,C,S	24-pin SMT	.690/.480/.225	M290
	1000B-5016	1CT:1CT	T	T	24-pin SMT	.600/.300/.163	M160
	1000B-5016X	1CT:1CT	T	T	24-pin SMT	.600/.300/.163	M160
	1000B-5017F	1CT:1CT	T,C	T,C	24-pin SMT	.715/.480/.260	M429
	1000B-5026F	1CT: 1CT	T,C	T,C	24-pin SMT	.705/.480/.180	M430
	1000B-5027 (PoE)	1CT:1CT	T,C,S	T,C,S	24-pin SMT	.695/.480/.180	M238
	1000B-5027X (PoE)	1CT:1CT	T,C,S	T,C,S	24-pin SMT	.695/.480/.180	M238
	1000B-5028FX	1CT:1CT	T	T	24-pin SMT	.600/.300/.163	M431
	1000B-5029	1CT:1CT	T,C	T,C	24-pin SMT	.700/.620/.185	M285
	1000B-5029X	1CT:1CT	T,C	T,C	24-pin SMT	.700/.620/.185	M285
	1000B-5033NL	1CT:1CT	T,C	T,C	24-pin SMT	.600/.430/.340	M433
	1000B-5035	1CT:1CT	T,C,S	T,C,S	24-pin SMT	.736/.537/.225	M434
	1000B-5036 (PoE)	1CT:1CT	T,C	T,C	24-pin SMT	.725/.490/.265	M435
	1000B-5037 (PoE)	1CT:1CT	T,C	T,C	24-pin SMT	.725/.633/.410	M436
	1000B-5042NL	1CT:1CT	T,C	T,C	24-pin SMT	.510/.520/.155	M437
	1000B-5045X	1CT: 1CT	T,C	T,C	24-pin SMT	.725/.490/.265	M438
	1000B-5046X	1CT:1CT	T,C	T,C	24-pin SMT	.725/.490/.265	M439
	10GB-6001	1CT: 1C	T,C	T,C	24-pin SMT	.700/.630/.235	M375
DUAL	1000B-5003	1CT:1CT	T, C	T,C	50-pin SMT	1.100/.430/.340	M1061
	1000B-5003X	1CT:1CT	T, C	T,C	50-pin SMT	1.100/.430/.340	M1061
	1000B-5003F	1CT:1CT	T, C	T,C	50-pin SMT	1.100/.430/.340	M106
	1000B-5003FX	1CT:1CT	T, C	T,C	50-pin SMT	1.100/.430/.340	M106
	1000B-5014	1CT:1CT	T, C, S	T,C,S	48-pin SMT	1.100/.610/.290	M160
	1000B-5014X	1CT:1CT	T, C, S	T,C,S	48-pin SMT	1.100/.610/.290	M160
	1000B-5020	1CT:1CT	T, C	T,C	48-pin SMT	.100/.610/.290	M286
	1000B-5020X	1CT:1CT	T, C	T,C	48-pin SMT	.100/.610/.290	M286

1. Web: <http://www.pulseruggedized.com> home page, click on "PRODUCT FINDER" and enter the part number.
2. Parts can be ordered Non-Lead by adding "NL" to the part number (i.e. 1000B-5003NL).
3. For Tape & Reel packaging, add the suffix "T" to the part number when ordering (i.e. 1000B-5002FXT)
4. T = Transformer, C = Choke, S = Shunt inductor
5. Standard Operating Temperature: -40°C to +85°C
6. Extended Operating Temperature (X): -55°C to +125°C
7. Isolation 1800Vrms
8. Parts compliant to IEEE 802.3 standard
PoE = Power over Ethernet Per IEEE 802.3af, 15 W



High Isolation Ethernet

Part Number	Insertion Loss (dB MAX)				Return Loss (dB MIN)				Crosstalk (dB MIN)				Differential to Common Mode Rejection (dB MIN)				Datasheet	Isolation		
	0.1-30 MHz	60 MHz	80 MHz	100 MHz	5 MHz	30 MHz	50 MHz	60 MHz	80 MHz	100 MHz	1 MHz	30 MHz	60 MHz	100 MHz	30 MHz	60 MHz			100 MHz	200 MHz
	X-1644NL	-1	-2	-2.5	-4	-18	-9	-5.5	-4.5	-3.0	-2.0	-45	-30	-27	-25	-36			-32	-30
X-1697	-1.5	-3	-3.5	-4.5	-18	-8	-5.5	-4.5	-3.3	-2	-45	-30	-27	-25	-36	-32	-30	-25	M514	10K VAC
100B-1014	-1.1	-1	/	-1.4	-20	-13	-10	-9	-7	/	-50	-40	-40	-35	-42	-37	-35	-35	M510	6K VAC
100B-1021	-1	-2	-3	-4	-18	-9	-5.5	-4.5	-3	-2	-45	-30	-27	-25	-36	-32	-30	-25	M511	8K VAC
100B-1044	-1	-1	-1	-1	-12	-12	-12	-12	-10	-8	-45	-30	-27	-25	-36	-32	-30	-25	M512	6K VAC
100B-1050	-1.5	-3	-3.5	-4.5	-18	-8	-5.5	-4.5	-3.3	-2	-45	-30	-27	-25	-36	-32	-30	-25	M513	6K VAC

1 The "NL" Suffix indicates a RoHS-compliant part number. Non-NL suffixed parts are not necessarily RoHS compliant, but are electrically and mechanically equivalent to NL versions.
 2. If a part number does not have the "NL" suffix, but a RoHS compliant version is required, please contact PulseR for availability.

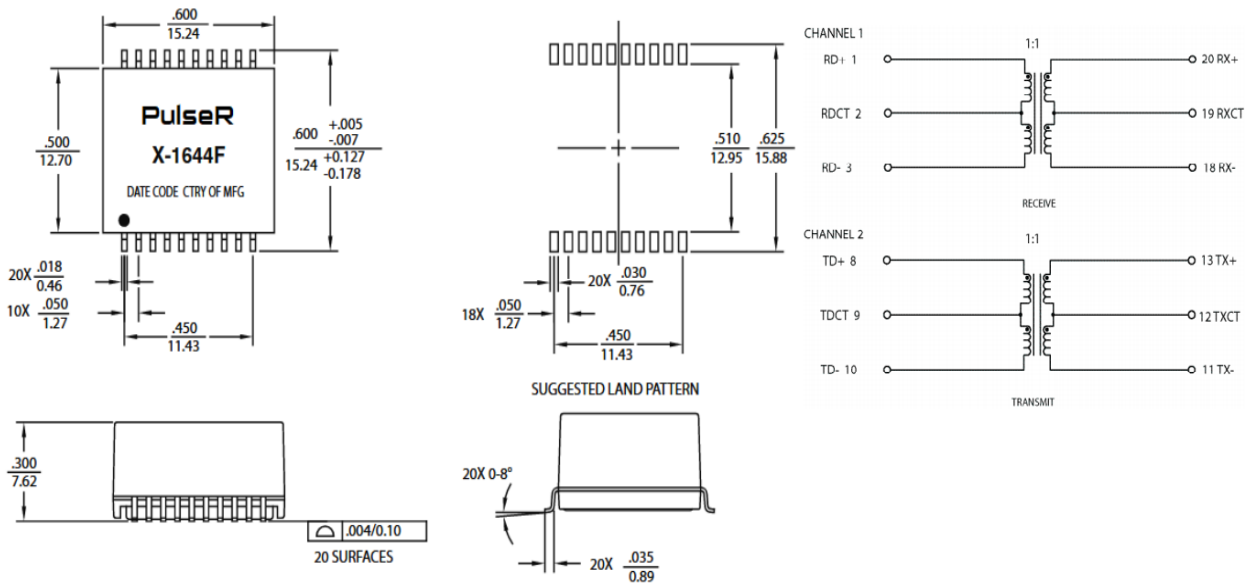

Weight 2.6 grams
 Tube 20/tube
 Tape & Reel 300/reel

Dimensions: Inches
 mm
 Unless otherwise specified, all tolerances are ±.010
 0,25



MIL-STD-1553 INTERFACE TRANSFORMERS

Non-QPL

Part Number	Turns Ratio (±3%)	Impedance (Ω MIN)	Package L/W/H (in.)	Data Sheet	Part Number	Turns Ratio (±3%)	Impedance (Ω MIN)	Package L/W/H (in.)	Data Sheet
FL1553-1	1CT:1CT/1CT:.707CT	4,000	.630/.630/.155	M227	STQ1553-2	1.4CT:1CT/2CT:1CT	7,200	.630/.630/.340	M230
GL1553-1	1CT:1CT/1CT:.707CT	4,000	.630/.630/.155	M227	STQ1553-3	1.25CT:1CT/1.66CT:1CT	4,000	.630/.630/.340	M230
TL1553-1	1CT:1CT/1CT:.707CT	4,000	.630/.630/.155	M226	STQ1553-5	1CT:2.12CT/1CT:1.5CT	4,000	.630/.630/.340	M230
FL1553-2	1.4CT:1CT/2CT:1CT	7,200	.630/.630/.155	M227	STQ1553-45	1.5CT/1CT:1.79CT	4,000	.630/.630/.340	M230
GL1553-2	1.4CT:1CT/2CT:1CT	7,200	.630/.630/.155	M227	SFQ1553-1	1CT:1CT/1CT:.707CT	4,000	.630/.630/.340	M231
TL1553-2	1.4CT:1CT/2CT:1CT	7,200	.630/.630/.155	M226	SGQ1553-1	CT:1CT/1CT:.707CT	4,000	.630/.630/.340	M231
FL1553-3	1.25CT:1CT/1.66CT:1CT	4,000	.630/.630/.155	M227	SFQ1553-2	1.4CT:1CT/2CT:1CT	7,200	.630/.630/.340	M231
GL1553-3	1.25CT:1CT/1.66CT:1CT	4,000	.630/.630/.155	M227	SGQ1553-2	1.4CT:1CT/2CT:1CT	7,200	.630/.630/.340	M231
TL1553-3	1.25CT:1CT/1.66CT:1CT	4,000	.630/.630/.15	M226	SFQ1553-3	1.25CT:1CT/1.66CT:1CT	4,000	.630/.630/.340	M231
FL1553-5	1CT:2.12CT/1CT:1.5CT	4,000	.630/.630/.155	M227	SGQ1553-3	1.25CT:1CT/1.66CT:1CT	4,000	.630/.630/.340	M231
GL1553-5	1CT:2.12CT/1CT:1.5CT	4,000	.630/.630/.155	M227	SFQ1553-5	1CT:2.12CT/1CT:1.5CT	4,000	.630/.630/.340	M231
TL1553-5	1CT:2.12CT/1CT:1.5CT	4,000	.630/.630/.155	M226	SGQ1553-5	1CT:2.12CT/1CT:1.5CT	4,000	.630/.630/.340	M231
FL1553-45	1CT:2.5CT/1CT:1.79CT	4,000	.630/.630/.155	M227	SFQ1553-45	1CT:2.5CT/1CT:1.79CT	4,000	.630/.630/.340	M231
GL1553-45	1CT:2.5CT/1CT:1.79CT	4,000	.630/.630/.155	M227	SGQ1553-45	1CT:2.5CT/1CT:1.79CT	4,000	.630/.630/.340	M231
TL1553-45	1CT:2.5CT/1CT:1.79CT	4,000	.630/.630/.155	M226	SLQG1553-1	1CT:1CT/1.4CT:1CT	4,000	.630/.630/.280	M234
DFL1553-1	1CT:1CT/1CT:.707CT	4,000	.930/.630/.155	M229	SLQG1553-2	1.4CT:1CT/2CT:1CT	7,200	.630/.630/.280	M234
DGL1553-1	1CT:1CT/1CT:.707CT	4,000	.930/.630/.155	M229	SLQG1553-3	1.25CT:1CT/1.66CT:1CT	4,000	.630/.630/.280	M234
DTL1553-1	1CT:1CT/1CT:.707CT	4,000	.930/.630/.155	M228	SLQG1553-5	1CT:2.12CT/1CT:1.5CT	4,000	.630/.630/.280	M234
DFL1553-2	1.4CT:1CT/2CT:1CT	7,200	.930/.630/.155	M229	SLQG1553-45	1CT:2.5CT/1CT:1.79CT	4,000	.630/.630/.280	M234
DGL1553-2	1.4CT:1CT/2CT:1CT	7,200	.930/.630/.155	M229	SLQT1553-1	1CT:1CT/1.4CT:1CT	4,000	.630/.630/.280	M234
DTL1553-2	1.4CT:1CT/2CT:1CT	7,200	.930/.630/.155	M228	SLQT1553-2	1.4CT:1CT/2CT:1CT	7,200	.630/.630/.280	M234
DFL1553-3	1.25CT:1CT/1.66CT:1CT	4,000	.930/.630/.155	M229	SLQT1553-3	1.25CT:1CT/1.66CT:1CT	4,000	.630/.630/.280	M234
DGL1553-3	1.25CT:1CT/1.66CT:1CT	4,000	.930/.630/.155	M229	SLQT1553-5	1CT:2.12CT/1CT:1.5CT	4,000	.630/.630/.280	M234
DTL1553-3	1.25CT:1CT/1.66CT:1CT	4,000	.930/.630/.155	M228	SLQT1553-45	1CT:2.5CT/1CT:1.79CT	4,000	.630/.630/.280	M234
DFL1553-5	1CT:2.12CT/1CT:1.5CT	4,000	.930/.630/.155	M229	X-1584	1CT:1.79CT	3,000	.500/.350/.172	M157
DGL1553-5	1CT:2.12CT/1CT:1.5CT	4,000	.930/.630/.155	M229	X-1596	1CT:2.5CT	3,000	.500/.350/.172	M157
DTL1553-5	1CT:2.12CT/1CT:1.5CT	4,000	.930/.630/.155	M228	Q1553-70*	1CT:3CT/1CT:2.15CT	4,000	.625/.625/.250	M128
DFL1553-45	1CT:2.5CT/1CT:1.79CT	4,000	.930/.630/.155	M229	SMQ1553-70*	1CT:3CT/1CT:2.15CT	4,000	.625/.625/.250	M128
DGL1553-45	1CT:2.5CT/1CT:1.79CT	4,000	.930/.630/.155	M229	GL1553-71*	1CT:3.54CT/1CT:2.50CT	4,000	.625/.625/.250	M128
DTL1553-45	1CT:2.5CT/1CT:1.79CT	4,000	.930/.630/.155	M228	DGL1553-71*	1CT:3.54CT/1CT:2.50CT	4,000	.625/.625/.250	M128
STQ1553-1	1CT:1CT/1CT:.707CT	4,000	.630/.630/.340	M230	TQ1553-71*	1CT:3.54CT/1CT:2.50CT	4,000	.625/.625/.250	M128

1. Custom capabilities are available.
2. Parts can be built and screened to Space NASA EEE-INST-002 requirements.
3. Web: <http://www.pulseruggedized.com> home page, click on the "PRODUCT FINDER" and enter the part number.

1. Designed and built to conform to MIL-PRF-21038/27 requirements.
 2. Parts can be built and screened to Space NASA EEE-INST-002 requirements.
 3. Web: <http://www.pulseruggedized.com> home page, click on "PRODUCT FINDER" and enter the part number.
- * For use with 3.3VDC Transceivers

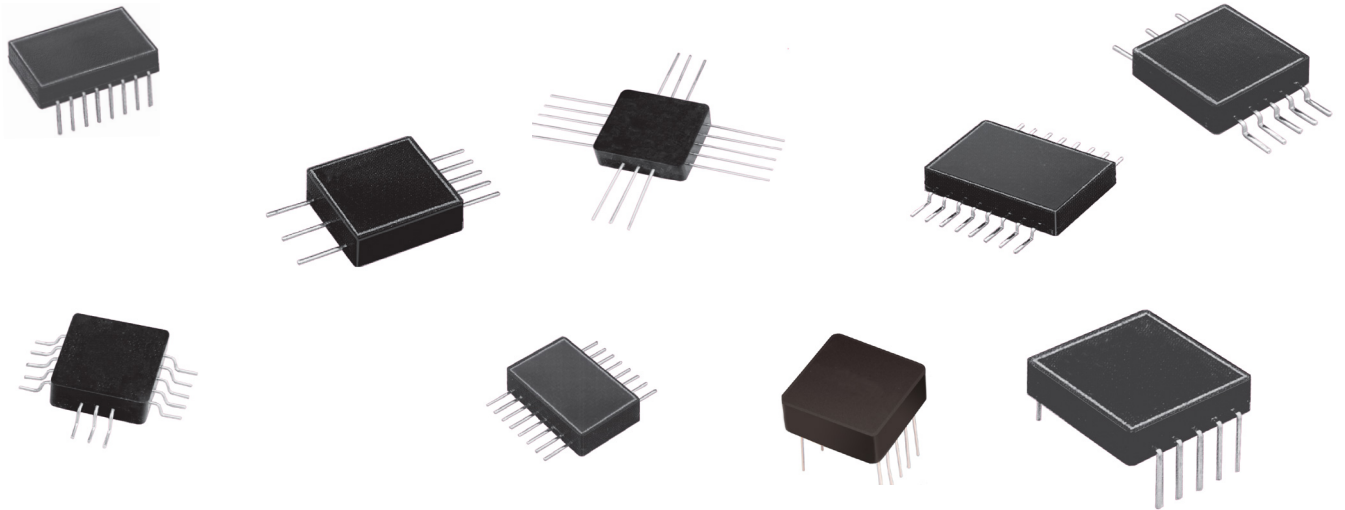

GENERAL PURPOSE PULSE TRANSFORMERS

TRANSFORMERS							
Part Number	Turns Ratio (1,5): (6,2) ±2%	Primary Inductance (1-5) (mH MIN)	DCR (1-5,6-2) (Ω MAX)	ET (V-us Min)	Insulation Resistance @250Vdc	Leakage Inductance (μH Max)	Datasheet
IZUHD	1CT:1CT	5.0	1.25	20	10KMohm	2.25	M480
IZUHE	1CT:1CT	3.0	1.25	10	10KMohm	2.70	M481

LOW SPEED DATA TRANSFORMER

T1/E1/CEPT/ISDN-PRI SMT TRANSFORMER							
Part Number	Turns Ratio Pri: Sec: ±2%	OCL Pri (mH MIN)	C _{ww} (pf MAX)	DCR Pri (Ω MAX)	Primary Pins	Package L/W/H (in.)	Datasheet
X-1707	1CT:1CT	1.0	25	0.8	1-3	.360/.405/.270	M487
PL1374	1CT:1CT	1.2	35	0.8	1-3	.300/.275/.250	M119
X-1688	1CT:1CT	1.2	35	0.8	1-3	.300/.275/.275	M486

LOW SPEED DATA TRANSFORMERS

64kbps ISOLATION TRANSFORMERS							
Part Number	Turns Ratio Pri: Sec: ±2%	Primary Inductance (μH MIN)	Leakage Inductance (μH MAX)	DCR Pri (Ω MAX)	Inter-winding Capacitance	Package L/W/H (in.)	Datasheet
X-1703	2:1	1.0mH	24	3.00	36	.940/.775/.810	M489
X-1709NL	1:2CT	20mH	5.0	2.65	130	.448/.335/.400	M483

HIGH SPEED DATA TRANSFORMER

FIBRE CHANNEL ISOLATION							
Part Number	Turns Ratio Pri: Sec: ±2%	Primary Inductance (μH MIN)	C _{ww} (pf MAX)	DCR Pri (Ω MAX)	Hi-Pot (Vrms MIN)	Package L/W/H (in.)	Datasheet
X-1704	1:1	7.5	5.0	.20	2000	.500/.270/.200	M482
X-1710	1:1	15.0	5.0	.20	1500	.495/.280/.200	M485

CAN BUS (COMMON MODE CHOKE)

80 VDC- 500Vrms							
Part Number	Turns Ratio Pri: Sec: ±2%	Inductance (100kHz) (μH +50%-30%)	Leakage Inductance (μH MAX)	DCR Resitance (Ω MAX)	Current Rating (mADC)	Package L/W/H (in.)	Datasheet
X-1711 NL	1:1	11	.16	.12	800	.310/.260/.250	M488
X-1712NL	1:1	25	.24	.12	800	.310/.260/.250	M488
X-1713NL	1:1	51	.22	.20	800	.310/.260/.250	M488
X-1714NL	1:1	100	.16	.24	800	.310/.260/.250	M488
X-1715NL	1:1	471	.27	.30	700	.310/.260/.250	M488
X-1716NL	1:1	1000	.43	.40	700	.310/.260/.250	M488

1. Visit our website: <http://www.pulseruggedized.com> home page, click on "PRODUCT FINDER" and enter the part number.
2. Parts can be ordered Non-Lead by adding "NL" to the part number (i.e. X-1703 becomes X-1703NL).
3. For Tape & Reel packaging, add the suffix "T" to the part number when ordering (i.e X-1709NL becomes X-1709NLT)

Non-QPL, Low Profile and Stacked (continued)

Part Number	Turns Ratio (± 3%)	Impedance (Ω MIN)	Package L/W/H (in.)	Data Sheet
SLQF1553-1	1CT:1CT/1.4CT:1CT	4,000	.630/.630/.280	M234
SLQF1553-2	1.4CT:1CT/2CT:1CT	7,200	.630/.630/.280	M234
SLQF1553-3	1.25CT:1CT/1.66CT:1CT	4,000	.630/.630/.280	M234
SLQF1553-5	1CT:2.12CT/1CT:1.5CT	4,000	.630/.630/.280	M234
SLQF1553-45	1CT:2.5CT/1CT:1.79CT	4,000	.630/.630/.280	M234

1. Designed and built to conform to MIL-PRF-21038/27
2. Web: <http://www.pulseruggedized.com> home page, click on "PRODUCT FINDER" and enter the part number.

Interface Transformers — COTS Series

Part ² Number	Turns Ratio (±3%)	Impedance (Ω MIN)	Package L/W/H in.	Data Sheet
(X)1553-1	1CT:1CT/1CT:707CT	4,000	.625/.625/.250	M233
(X)1553-2	1.4CT:1CT/2CT:1CT	7,200	.625/.625/.250	M233
(X)1553-3	1.25CT:1CT/1.66CT:1CT	4,000	.625/.625/.250	M233
(X)1553-5	1CT:2.12CT/1.5CT:1CT	4,000	.625/.625/.250	M233
(X)1553-45	1CT:2.5CT/1CT:1.79CT	4,000	.625/.625/.250	M233

1. Designed and built to conform to MIL-PRF-21038/27
2. Prefix/Operating Temperature: C/0°C to +70°C; N/-40°C to +85°C; TQ/-55°C to +125°C
3. Web: <http://www.pulseruggedized.com> home page, click on "PRODUCT FINDER" and enter the part number.

Interface Transformers — Low Profile Miniature Series

Part Number	Turns Ratio (±3%)	Impedance (Ω MIN)	Package (L/W/H) in.	Data Sheet
SMG1553-60	1.25CT:1CT	4,000	.400/.400/.185	M112
SMG1553-61	1.66CT:1CT	4,000	.400/.400/.185	M112
SMG1553-65	1CT:2.5CT	4,000	.400/.400/.185	M112
SMG1553-66	1CT:1.79CT	4,000	.400/.400/.185	M112
SMG1553-67	1CT:2.7CT	4,000	.400/.400/.185	M112
SMG1553-68	1CT:3.75CT	4,000	.400/.400/.185	M112

Dual Interface Transformers- Low Profile, Miniature Series

Part Number	Turns Ratio (±3%)	Impedance (Ω MIN)	Package (L/W/H) in.	Data Sheet
DKG1553-45	1CT:2.50CT/1CT:1.79CT	4,000	.675/.400/.185	M322
DKG1553-70	1CT:3.00CT/1CT:2.15CT	4,000	.675/.400/.185	M322
DKG1553-71	1CT:3.54CT/1CT:2.70CT	4,000	.675/.400/.185	M222
DKG1553-72	1CT:2.65CT/1CT:2.07CT	4,000	.675/.400/.185	M322

1. Designed, built and tested to MIL-PRF-21038 & MIL-STD-202
 Level M (Standard): for general purpose military applications
 Level T (Optional): for high-reliability, critical, military applications
2. Web: <http://www.pulseruggedized.com> home page, click on the "PRODUCT FINDER" and enter the part number.

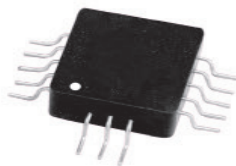

QPL Series — Qualified to MIL-PRF-21038/27

Part Number	Military Designation Number	Turns Ratio (±3%)	Impedance (Ω MIN)	Package L/W/H (in.)	Data Sheet
Q1553-20	M21038/27-05	1:1.41	3,000	.500/.350/.250	M223
Q1553-21	M21038/27-06	1CT:1CT	3,000	.500/.350/.250	M223
Q1553-22	M21038/27-07	1CT:1.41CT	3,000	.500/.350/.250	M223
Q1553-23	M21038/27-08	1CT:1.66CT	3,000	.500/.350/.250	M223
Q1553-24	M21038/27-09	1CT:2CT	3,000	.500/.350/.250	M223
Q1553-25	M21038/27-28	1CT:1.5CT	3,000	.500/.350/.250	M223
Q1553-51	M21038/27-29	1CT:1.79CT	3,000	.500/.350/.250	M223
Q1553-52	M21038/27-30	1CT:2.5CT	3,000	.500/.350/.250	M223
Q1553-1	M21038/27-01	1CT:1CT/1CT:707CT	4,000	.625/.625/.250	M224
Q1553-2	M21038/27-02	1.4CT:1CT/2CT:1CT	7,200	.625/.625/.250	M224
Q1553-3	M21038/27-03	1.25CT:1CT/1.66CT:1CT	4,000	.625/.625/.250	M224
Q1553-5	M21038/27-10	1CT:2.12CT/1CT:1.5CT	4,000	.625/.625/.250	M224
Q1553-45	M21038/27-26	1CT:2.5CT/1CT:1.79CT	4,000	.625/.625/.250	M224
Q1553-81	M21038/27-21	1CT:1CT/1CT:707CT	4,000	.625/.625/.275	M224
Q1553-82	M21038/27-22	1.4CT:1CT/2CT:1CT	7,200	.625/.625/.275	M224
Q1553-83	M21038/27-23	1.25CT:1CT/1.66CT:1CT	4,000	.625/.625/.275	M224
Q1553-84	M21038/27-24	1CT:2.12CT/1CT:1.5CT	4,000	.625/.625/.275	M224
Q1553-85	M21038/27-25	1CT:2.5CT/1CT:1.79CT	4,000	.625/.625/.275	M224
FPQ1553-6	M21038/27-16	1CT:1CT/1CT:707CT	4,000	.625/.625/.250	M225
SMQ1553-6	M21038/27-11	1CT:1CT/1CT:707CT	4,000	.625/.625/.250	M225
FPQ1553-7	M21038/27-17	1.4CT:1CT/2CT:1CT	7,200	.625/.625/.250	M225
SMQ1553-7	M21038/27-12	1.4CT:1CT/2CT:1CT	7,200	.625/.625/.250	M225
FPQ1553-8	M21038/27-18	1.25CT:1CT/1.66CT:1CT	4,000	.625/.625/.250	M225
SMQ1553-8	M21038/27-13	1.25CT:1CT/1.66CT:1CT	4,000	.625/.625/.250	M225
FPQ1553-10	M21038/27-20	1CT:2.12CT/1CT:1.5CT	4,000	.625/.625/.250	M225
SMQ1553-10	M21038/27-15	1CT:2.12CT/1CT:1.5CT	4,000	.625/.625/.250	M225
FPQ1553-45	M21038/27-31	1CT:2.5CT/1CT:1.79CT	4,000	.625/.625/.250	M225
SMQ1553-45	M21038/27-27	1CT:2.5CT/1CT:1.79CT	4,000	.625/.625/.250	M225

1. Part number options: C and T level QPL testing (xxQC1553-xx, xxQT1553-xx, M21038/27-xxC, M21038/27-xxT).
 Product Level: This specification makes provision for three product levels:
 Level C: for high reliability commercial/industrial type applications
 Level M: for general purpose military applications
 Level T: for high-reliability, critical, applications.
2. Web: <http://www.pulseruggedized.com> home page, click on "PRODUCT FINDER" and enter the part number.
3. Summary Performance Specifications:
 Droop = 20%
 Overshoot = ±1 V MAX;
 Common Mode Rejection = 45 dB
 Frequency Range (no load) = 75 kHz to 1 MHz
 Operating Temperature Range = -55°C to +130°C
 Weight = 5 grams
 Insulation Resistance = 10 kMΩ @ 250 Vdc
 Dielectric Withstanding Voltage = 100 Vrms

PulseR, L.L.C. is the leading manufacturer of magnetic components with 70-years experience, originally founded as Technitrol in 1947. PulseR offers custom and catalog power magnetics ruggedized for Military, MIL-PRF-27, MIL-STD-981 and high reliability applications. Pulse has a full line of "Off-the-Shelf" inductors for military and aerospace power applications in SLED, SLIC and POGO series packaging. The SLED, SLIC and POGO series use ruggedized high temperature headers suitable for surface mounting to Printed Circuit Board assemblies. Cores are securely bonded to the headers allowing parts to meet MIL-PRF-27 environmental requirements. PulseR offers shielded drum core inductors and planar transformers incorporating ruggedized PCB mounting clips that have superior performance in applications with shock and vibration requirements.

PulseR offers catalog offerings of Gate Drive transformers with high isolation as well as miniature current sense transformers.

PulseR continues to offer tin/lead termination finishes for Military, Space and Aerospace applications requiring the highest reliability. Parts can also be purchased with tin/lead finishes where RoHS and REACH compliance are required. PulseR offers complete design support, qualification test services and global AS9100 manufacturing capabilities



OFF-THE-SHELF POWER INDUCTORS & CHOKES

Toroid Power Inductors - SLED Series						
Part Number	@ I _{RATED} (μH) TYP	I _{RATED} (A)	DCR (mΩ MAX)	Inductance @0A _{DC} (μH)TYP	Package L/W/H (in.)	Data Sheet
SLED 20						
PL8100	1.01	3.40	11	1.1	.400/.345/.250	M107
PL8101	6.2	1.40	70	7	.400/.345/.250	M107
PL8102	17.6	1.00	125	22.7	.400/.345/.250	M107
SLED 30						
PL8110	3.8	4.80	17.3	5.2	.625/.525/.400	M107
PL8111	9.4	2.80	43.4	12.3	.625/.525/.400	M107
PL8112	29.7	1.40	166	35.3	.625/.525/.400	M107
PL8113	114	0.94	380	167	.625/.525/.400	M107
SLED 40						
PL8120	2.5	8.00	8.3	3.8	.725/.575/.410	M107
PL8121	5.1	5.40	17.7	7.5	.725/.575/.410	M107
PL8122	16.2	2.70	72	21.9	.725/.575/.410	M107
PL8123	58.1	1.30	290	73	.725/.575/.410	M107
PL8124	192	0.90	560	292	.725/.575/.410	M107
PL8125	383	0.72	862	672	.725/.575/.410	M107
PL8130	4.9	7.80	12.4	7.9	.725/.575/.410	M107
PL8131	9	5.50	28	14	.725/.575/.410	M107
PL8132	29.1	2.70	100	40.5	.725/.575/.410	M107
PL8133	645	0.74	1250	1134	.725/.575/.410	M107
PL8150	0.81	14.30	2.5	1.25	.725/.575/.410	M107
PL8151	1.32	11.50	4.0	2.1	.725/.575/.410	M107
SLED 50						
PL8140	9.3	7.20	18.7	16	.900/.690/.520	M107
PL8141	16.1	5.10	32.0	25.9	.900/.690/.520	M107
PL8142	50	2.60	133	72.9	.900/.690/.520	M107
PL8143	1070	0.71	1700	1950	.900/.690/.520	M107
PL8160	1.68	13.90	3.6	2.8	.900/.690/.520	M107
PL8161	2.5	11.40	5.4	4.2	.900/.690/.520	M107
PL8170	3.5	12.40	6.6	6.5	.900/.690/.520	M107
PL8171	4.7	10.40	8.3	8.4	.900/.690/.520	M107

SMT Common Mode Chokes: SLIC Series					
Part Number	Inductance (mH ±35%)	I _{RATED} (A)	DCR (mΩ MAX)	Package L/W/H (in.)	Data Sheet
SLIC Series, Common Mode Chokes					
PL8200	0.47	14.0	8	1.220/1.000/500	M108
PL8201	0.63	11.6	10	1.220/1.000/500	M108
PL8202	0.81	9.70	14	1.220/1.000/500	M108
PL8203	0.53	7.20	15	1.110/1.00/395	M108
PL8204	0.59	5.60	21	.770/.670/390	M108
PL8205	0.77	4.70	40	.770/.670/390	M108
PL8206	0.22	3.30	60	.770/.670/390	M108
PL8207	1.32	3.30	60	.770/.670/390	M108
PL8208	1.47	2.80	80	.770/.670/390	M108
PL8209	0.88	1.63	110	.500/.500/215	M108
PL8210	1.17	1.22	200	.500/.500/215	M108
PL8211	10.15	1.40	210	.770/.670/395	M108
PL8212	1.125	1.80	55	.500/.519/200	M108
PL8213	0.80	3.00	27	.511/.511/338	M108
PL8214	.383	3.3	18	.511/.511/220	M108
PL8215	.536	3.8	17.1	.645/.560/350	M108
PL8216	.280	4.0	13.2	.511/.511/220	M108
PL8217	.486	4.2	16.0	.716/.590/299	M108
PL8218	.130	5.0	6.75	.519/.519/220	M108
PL8219	.096	6.0	4.30	.519/.519/200	M108
PL8220	.400	6.0	9.4	.716/.590/393	M108
PL8221	.061	7.0	2.9	.531/.531/220	M108
PL8222	4.84	8.0	7.7	.770/.670/395	M108
PL8223	1.22	9.0	9.75	1.22/1.00/500	M108
PL8224	.215	10	3.0	.830/.751/441	M108
PL8225	.095	12.5	3.0	.770/.670/395	M108
PL8226	.117	14	1.9	.830/.751/441	M108
PL8227	.550	16	4.25	1.22/1.00/500	M108
PL8228	.380	20	4.1	1.22/1.00/500	M108

1. Parts can be ordered Non-Lead by adding "NL" to the part number (i.e. PL8210NL).
2. For Tape & Reel packaging, add the suffix "T" to the part number when ordering (i.e. PL8210NLT)
3. Web: <http://www.pulseruggedized.com> home page, click on "PRODUCT FINDER" and enter the part number.



OFF-THE-SHELF POWER INDUCTORS & CHOKES

SMT Power Inductors: SLIC (HCCI-80) Series

Part ¹ Number	@ I _{RATED} (μH) TYP	I _{RATED} (A)	DCR (mΩ MAX)	Inductance @0A _{DC} (μH) TYP	Package L/W/H (in.)	Data Sheet
SLIC (HCCI) Series						
PL8304 ^P	1.1	38	1.3	2.1	1.220/1.000/500	M109
PL8303 ^P	1.6	34	1.6	3.5	1.220/1.000/500	M109
PL8302 ^P	2.45	27	2.5	5.1	1.220/1.000/500	M109
PL8301 ^P	3.2	24	3.5	7.2	1.220/1.000/500	M109
PL8300 ^P	4.52	19	4.8	9.5	1.220/1.000/500	M109
PL8300 ^S	18.1	9.5	19.3	38.0	1.220/1.000/500	M109

1. Connection: P = Parallel, S = Series

SMT Power Inductors: Toroid, SLED Series

Part ¹ Number	@ I _{RATED} (μH) TYP	I _{RATED} (A)	DCR (mΩ MAX)	Inductance @0A _{DC} (μH) TYP	Package L/W/H (in.)	Data Sheet
SLED 25						
PL8500	9.4	3.8	32	10.4	.625/.525/.310	M113
PL8501	13.3	3.2	46	14.6	.625/.525/.310	M113
PL8502	23	2.4	74	25	.625/.525/.310	M113
PL8503	50	1.6	135	56	.625/.525/.310	M113
PL8504	75	1.3	220	83	.625/.525/.310	M113
PL8505	90	1.2	285	100	.625/.525/.310	M113
PL8506	137	1	425	152	.625/.525/.310	M113
PL8507	200	.82	673	220	.625/.525/.310	M113
PL8508	305	.66	972	331	.625/.525/.310	M113
PL8509	439	.56	1520	472	.625/.525/.310	M113

SMT Power Inductors: Toroid, POGO Series

Part ¹ Number	@ I _{RATED} (μH) MIN	I _{RATED} (A)	DCR (mΩ MAX)	Inductance @0A _{DC} (μH) TYP	Package L/W/H (in.)	Data Sheet
POGO 25						
PL8600 ^P	2.0	8.30	8.0	2.2	.625/.525/.310	M114
PL8601 ^P	2.4	7.20	10.9	2.6	.625/.525/.310	M114
PL8602 ^P	5.0	5.20	19.0	5.5	.625/.525/.310	M114
PL8600 ^S	7.0	4.16	16.0	8.75	.625/.525/.310	M114
PL8603 ^P	9.3	3.80	30.0	10.4	.625/.525/.310	M114
PL8601 ^S	8.4	3.78	21.8	10.4	.625/.525/.310	M114
PL8604 ^P	14.1	3.10	45.5	15.7	.625/.525/.310	M114
PL8605 ^P	19.8	2.6	66.5	22.1	.625/.525/.310	M114
PL8602 ^S	17.9	2.6	38.0	22.45	.625/.525/.310	M114
PL8606 ^P	29.3	2.20	101	32.8	.625/.525/.310	M114
PL8603 ^S	33.8	1.89	60	41.7	.625/.525/.310	M114
PL8607 ^P	42.6	1.80	151	47.6	.625/.525/.310	M114
PL8604 ^S	50.9	1.54	91	62.8	.625/.525/.310	M114
PL8608 ^P	61.3	1.50	222	67.5	.625/.525/.310	M114
PL8605 ^S	71.5	1.30	133	88.2	.625/.525/.310	M114

SMT Power Inductors: Toroid, POGO Series

Part ¹ Number	@ I _{RATED} (μH) MIN	I _{RATED} (A)	DCR (mΩ MAX)	Inductance @0A _{DC} (μH) TYP	Package L/W/H (in.)	Data Sheet
POGO 40						
PL8400 ^S	43.6	1.1	309	247.2	.725/.575/.310	M111
POGO 50						
PL8401 ^S	21.9	2.7	90.5	72.4	.910/.700/.400	M111
PL8402 ^S	4.025	6.4	23.0	18.4	.910/.700/.400	M111
PL8403 ^P	0.53	23.8	3.0	1.0	.910/.700/.400	M111
PL8404 ^P	1.1	21	2.5	1.7	.910/.700/.400	M111
POGO 60						
PL8405 ^P	2.1	22.4	3.4	2.5	1.280/.1070/.400	M111

1. Connection: P=Parallel, S = Series
2. Parts can be ordered Non-Lead by adding "NL" to the part number (i.e. PL8603NL).
3. For Tape & Reel packaging, add, the suffix "T" to the part number when ordering (i.e. PL8603NLT)
4. Web: <http://www.pulseruggedized.com> home page, click on the "PRODUCT FINDER" and enter the part

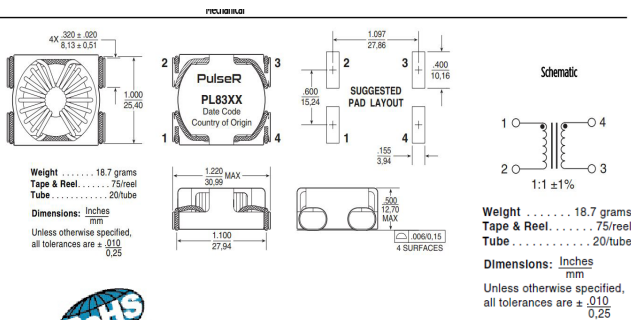

SLED



Pan & Tube35/tube
Tape & Reel300/reel
MSL3
Dimensions: Inches
mm
Unless otherwise specified,
all tolerances are ± 0.10
0.25



POGO

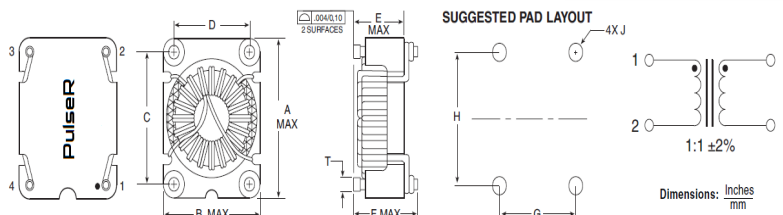

Pan & Tube30/tube
Tape & Reel300/reel
MSL3
Dimensions: Inches
mm
Unless otherwise specified,
all tolerances are ± 0.10
0.25

OFF-THE-SHELF POWER INDUCTORS (continued)

SMT Power Inductors: Toroid, POGO Series (continued)

Part ¹ Number	@ I _{RATED} (μH) MIN	I _{RATED} (A)	DCR (mΩ MAX)	Inductance ² @0A _{DC} (μH) TYP	Package L/W/H (in.)	Data Sheet
POGO 25 (continued)						
PL8609 ^P	84.2	1.20	318	91.0	.625/.525/.310	M114
PL8606 ^S	106.1	1.07	202	131.0	.625/.525/.310	M114
PL8607 ^S	154.2	0.89	302	190.3	.625/.525/.310	M114
PL8608 ^S	218.9	0.74	444	270.2	.625/.525/.310	M114
PL8609 ^S	295.0	0.64	636	364.0	.625/.525/.310	M114

Part ¹ Number	@ I _{RATED} (μH) MIN	I _{RATED} (A)	DCR (mΩ MAX)	Inductance ² @0A _{DC} (μH) TYP	Package L/W/H (in.)	Data Sheet
POGO 40						
PL8700 ^P	1.5	14.40	4.41	2.2	.725/.575/.380	M115
PL8701 ^P	2.4	9.40	6.54	3.5	.725/.575/.380	M115
PL8702 ^P	4.2	8.10	10.47	5.9	.725/.575/.380	M115
PL8703 ^P	5.8	6.80	14.94	7.9	.725/.575/.380	M115
PL8704 ^P	7.6	5.70	20.99	10.1	.725/.575/.380	M115
PL8705 ^P	12.1	5.20	23.24	18.5	.725/.575/.380	M115
PL8706 ^P	18.0	4.20	38.15	27.4	.725/.575/.380	M115
PL8707 ^P	27.0	3.30	53.21	40.5	.725/.575/.380	M115
PL8708 ^P	34.8	2.30	73.89	50.5	.725/.575/.380	M115
PL8700 ^S	6.1	7.20	17.60	9.0	.725/.575/.380	M115
PL8701 ^S	9.7	5.60	26.20	14.0	.725/.575/.380	M115
PL8702 ^S	17.0	4.10	41.90	23.7	.725/.575/.380	M115
PL8703 ^S	23.1	3.40	59.70	31.5	.725/.575/.380	M115
PL8704 ^S	30.6	2.85	84.00	40.5	.725/.575/.380	M115
PL8705 ^S	48.5	2.70	93.00	74.1	.725/.575/.380	M115
PL8706 ^S	72.0	2.20	152.60	109.8	.725/.575/.380	M115
PL8707 ^S	108.0	1.77	212.80	161.8	.725/.575/.380	M115
PL8708 ^S	139.1	1.50	295.60	202.2	.725/.575/.380	M115

1. Connection: Superscript P = Parallel, S = Series

Part ¹ Number	@ I _{RATED} (μH) MIN	I _{RATED} (A)	DCR (mΩ MAX)	Inductance ² @0A _{DC} (μH) TYP	Package L/W/H (in.)	Data Sheet
POGO 50 (continued)						
PL8401 ^S	21.9	2.7	90.5	39.5	.910/.700/.510	M114
PL8402 ^S	106.1	1.07	202	131.0	.625/.525/.310	M114
PL8403 ^S	154.2	0.89	302	190.3	.625/.525/.310	M114
PL8404 ^S	218.9	0.74	444	270.2	.625/.525/.310	M114

Part ¹ Number	@ I _{RATED} (μH) MIN	I _{RATED} (A)	DCR (mΩ MAX)	Inductance ² @0A _{DC} (μH) TYP	Package L/W/H (in.)	Data Sheet
POGO 60						
PL8405 ^P	2.1	22.4	3.4	4	1.280/1.070/.510	M111

1. Connection: P = Parallel, S = Series

SMT Common Mode Inductors: Toroid, POGO Series

Part Number	Inductance (mH ±30%)	I _{RATED} (A)	DCR (mΩ) MAX	SRF (MHz)	Impedance Curve	Package L/W/H (in.)	Data Sheet
POGO 40							
PL8801	1.5	1.50	60	2	2	.725/.575/.380	M116
PL8803	10.0	1.00	450	0.5	4	.725/.575/.380	M116
PL8804	22.0	0.50	850	0.3	5	.725/.575/.380	M116

Part Number	Inductance (mH ±30%)	I _{RATED} (A)	DCR (mΩ) MAX	SRF (MHz)	Impedance Curve	Package L/W/H (in.)	Data Sheet
POGO 50							
PL8800	1.0	3.60	50	4	1	.910/.700/.510	M116
PL8802	3.0	2.50	80	2.2	3	.910/.700/.510	M116

1. See graph below.

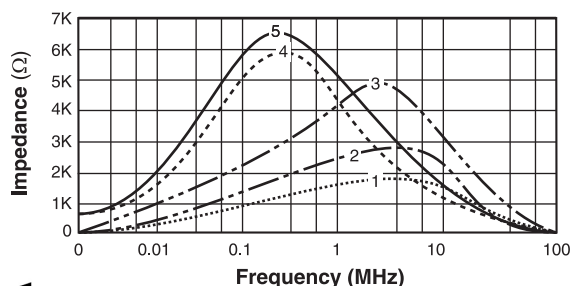

SMT Power Inductors: Shielded Drum Core

Part Number	Inductance @I _{RATED} (μH TYP)	I _{RATED} (A)	DCR (mΩ MAX)	Inductance ² @0A _{DC} (μH) TYP	Saturation Current @25°C	Package L/W/H (in.)	Data Sheet
PL8901	0.80	11	4.0	1.0 ²	14	.413/.413/.280	M117
PL8902	1.20	10	6.0	1.5 ²	13	.413/.413/.280	M117
PL8903	2.1	9.0	7.3	2.7 ²	11	.413/.413/.280	M117
PL8904	2.9	8.0	8.5	3.7 ²	9.2	.413/.413/.280	M117
PL8905	3.7	7.3	9.5	4.7 ²	8.2	.413/.413/.280	M117
PL8906	4.8	6.0	16.5	6.0 ²	6.9	.413/.413/.280	M117
PL8907	6	5.5	18.5	7.6 ²	6.2	.413/.413/.280	M117
PL8908	8	5.0	21.8	10	5.5	.413/.413/.280	M117
PL8909	9.6	4.5	29.0	12	5.1	.413/.413/.280	M117
PL8910	12	4.1	35.4	15	4.4	.413/.413/.280	M117
PL8911	14.4	4.0	37.0	18	4.3	.413/.413/.280	M117
PL8912	17.6	3.8	42.0	22	3.8	.413/.413/.280	M117
PL8913	21.6	3.4	45.9	27	3.4	.413/.413/.280	M117
PL8914	26.4	3.0	64.8	33	3.0	.413/.413/.280	M117
PL8915	31.2	2.7	81.5	39	2.8	.413/.413/.280	M117
PL8916	37.6	2.6	89.0	47	2.6	.413/.413/.280	M117
PL8917	54.4	2.1	135.0	68	2.1	.413/.413/.280	M117
PL9101	0.96	10.5	4.5	1.0 ²	12.7	.413/.413/.248	M121
PL9102	1.52	9.5	5.5	1.8 ²	10.1	.413/.413/.248	M121
PL9103	2.34	7.8	7.8	2.7 ²	8.4	.413/.413/.248	M121
PL9104	3.27	6.7	11.0	3.9 ²	7.2	.413/.413/.248	M121
PL9105	4.39	5.6	15.6	5.1 ²	6.3	.413/.413/.248	M121
PL9106	5.54	5.2	18.0	6.8 ²	5.6	.413/.413/.248	M121
PL9107	6.73	5.0	20.0	8.2 ²	5.1	.413/.413/.248	M121
PL9108	8.19	4.6	22	10	4.6	.413/.413/.248	M121
PL9109	9.9	4.2	27	12	4.2	.413/.413/.248	M121
PL9110	13.4	3.6	30	15	3.6	.413/.413/.248	M121
PL9111	15.4	3.4	40	18	3.4	.413/.413/.248	M121
PL9112	17.6	3.2	45	22	3.2	.413/.413/.248	M121
PL9113	22.5	2.8	62	27	2.8	.413/.413/.248	M121
PL9114	28.5	2.5	70	33	2.5	.413/.413/.248	M121
PL9115	31.4	2.4	75	39	2.4	.413/.413/.248	M121
PL9116	38.4	2.2	100	47	2.2	.413/.413/.248	M121
PL9117	48.3	1.9	110	56	1.9	.413/.413/.248	M121
PL9118	55.9	1.8	120	68.0	1.8	.413/.413/.248	M121
PL9119	67.6	1.7	178	82.0	1.7	.413/.413/.248	M121
PL9120	86.1	1.4	230	100.0	1.4	.413/.413/.248	M121
PL9121	103	1.3	253	120.0	1.3	.413/.413/.248	M121
PL9122	121	1.2	280	150.0	1.2	.413/.413/.248	M121
PL9123	149	1.1	310	180.0	1.1	.413/.413/.248	M121
PL9124	186	1.0	400	220.0	1.0	.413/.413/.248	M121
PL9125	224	0.91	460	270	0.91	.413/.413/.248	M121
PL9126	279	0.82	690	330	0.82	.413/.413/.248	M121
PL9127	335	0.72	760	390	0.72	.413/.413/.248	M121
PL9128	398	0.68	850	470	0.68	.413/.413/.248	M121
PL9129	464	0.63	1060	560	0.63	.413/.413/.248	M121
PL9130	563	0.57	1200	680	0.57	.413/.413/.248	M121
PL9131	681	0.52	1550	820	0.52	.413/.413/.248	M121
PL9132	879	0.46	1750	1000	0.46	.413/.413/.248	M121

- The rated current as listed is either the saturation current or the heating current depending on which value is lower.
- Inductance at 0A_{DC} tolerance is ±30%. The tolerance is ±20% on all other parts. Optional Tape & Reel packaging can be ordered by adding a "T" suffix to the end of the part number.
- Web: <http://www.pulseruggedized.com> home page, click on "PRODUCT FINDER" and enter the part number.



continued on the next page

OFF-THE-SHELF POWER INDUCTORS (continued)

SMT Power Inductors: Shielded Drum Core (continued)

Part Number	Inductance @I _{RATED} (μH TYP)	I _{RATED} ¹ (A)	DCR (mΩ MAX)	Inductance @0A _{DC} (μH) TYP	Saturation Current @25°C	Package L/W/H (in.)	Data Sheet	Part Number	Inductance @I _{RATED} (μH TYP)	I _{RATED} (A)	DCR (mΩ MAX)	Inductance @0A _{DC} (μH) TYP	Saturation Current @25°C	Package L/W/H (in.)	Data Sheet
PL9201	0.95	8.7	5.7	1.0	11	.413/.413/.201	M122	PL9402	1.3	6.10	6.4	1.5	6.10	.410/.410/.132	M123
PL9202	1.55	7.4	7.9	1.6	8.8	.413/.413/.201	M122	PL9403	2.1	5.70	10.4	2.2	5.70	.410/.410/.132	M123
PL9203	2.32	6.6	10.0	2.7	7.3	.413/.413/.201	M122	PL9404	3.1	4.80	15.6	3.3	4.80	.410/.410/.132	M123
PL9204	3.24	5.5	4.5	3.6	6.3	.413/.201/.201	M122	PL9405	4.5	4.10	21.2	4.7	4.10	.410/.410/.132	M123
PL9205	4.26	5.1	16.5	4.5	5.5	.413/.413/.201	M122	PL9406	5.8	3.60	25.2	6.2	3.60	.410/.410/.132	M123
PL9206	5.64	4.4	22	6.0	4.9	.413/.413/.201	M122	PL9407	7.0	3.30	27.8	6.8	3.30	.410/.410/.132	M123
PL9207	7.17	4.2	25	7.6	4.4	.413/.413/.201	M122	PL9408	9.4	3.00	39.5	8.2	3.00	.410/.410/.132	M123
PL9208	9.3	3.6	35	10	4.0	.413/.413/.201	M122	PL9409	11	2.70	42.9	10	2.70	.410/.410/.132	M123
PL9209	10.8	3.3	37	12	3.7	.413/.413/.201	M122	PL9410	12	2.40	50.0	12	2.40	.410/.410/.132	M123
PL9210	13.4	3.0	47	15	3.4	.413/.413/.201	M122	PL9411	15	2.25	65.2	15	2.25	.410/.410/.132	M123
PL9211	17.5	2.7	58	18	2.9	.413/.413/.201	M122	PL9412	24	1.85	86.1	22	1.85	.410/.410/.132	M123
PL9212	19.4	2.6	67	22	2.8	.413/.413/.201	M122	PL9413	35	1.40	126	33	1.40	.410/.410/.132	M123
PL9213	24.2	2.2	79	27	2.4	.413/.413/.201	M122	PL9414	48	1.25	188	47	1.25	.410/.410/.132	M123
PL9214	30.6	2.1	94	33	2.2	.413/.413/.201	M122	PL9415	55	1.15	208	56	1.15	.410/.410/.132	M123
PL9215	38.5	1.8	126	39	2.0	.413/.413/.201	M122	PL9416	64	1.05	279	68	1.05	.410/.410/.132	M123
PL9216	46.1	1.7	140	47	1.8	.413/.413/.201	M122	PL9417	88	0.94	317	82	0.94	.410/.410/.132	M123
PL9217	53.2	1.6	157	56	1.7	.413/.413/.201	M122	PL9418	106	0.88	358	100	0.88	.410/.410/.132	M123
PL9218	63.1	1.45	202	68.0	1.6	.413/.413/.201	M122	PL9419	129	0.80	478	120	0.80	.410/.410/.132	M123
PL9219	76.6	1.36	232	82.0	1.4	.413/.413/.201	M122	PL9420	157	0.70	545	150	0.70	.410/.410/.132	M123
PL9220	88	1.29	270	100.0	1.3	.413/.413/.201	M122	PL9421	238	0.58	837.0	220	0.58	.410/.410/.132	M123
PL9221	112	1.07	316	120.0	1.2	.413/.413/.201	M122	PL9422	325	0.45	1199	330	0.45	.410/.410/.132	M123
PL9222	135	1.02	456	150.0	1.05	.413/.413/.201	M122	PL9501	2.15	2.60	17.6	2.5	2.6	.256/.256/.122	M124
PL9223	132	0.87	497	180.0	0.96	.413/.413/.201	M122	PL9502	2.58	2.30	20.3	3.3	2.3	.256/.256/.122	M124
PL9224	198	0.82	681	220.0	0.86	.413/.413/.201	M122	PL9503	3.43	2.10	27.0	4	2.1	.256/.256/.122	M124
PL9225	237	0.78	775	270	0.79	.413/.413/.201	M122	PL9504	4.63	1.85	31.1	5	1.85	.256/.256/.122	M124
PL9226	296	0.66	955	330	0.71	.413/.413/.201	M122	PL9505	5.22	1.70	41.9	6	1.7	.256/.256/.122	M124
PL9227	355	0.58	1087	390	0.66	.413/.413/.201	M122	PL9506	6.57	1.50	49.9	8	1.5	.256/.256/.122	M124
PL9228	445	0.54	1403	470	0.59	.413/.413/.201	M122	PL9507	8.65	1.30	54.0	10	1.3	.256/.256/.122	M124
PL9229	495	0.53	1623	560	0.54	.413/.413/.201	M122	PL9508	9.78	1.20	72.0	12	1.2	.256/.256/.122	M124
PL9230	610	0.49	1824	680	0.49	.413/.413/.201	M122	PL9509	12.13	1.10	82.0	15	1.1	.256/.256/.122	M124
PL9231	702	0.43	2355	820	0.45	.413/.413/.201	M122	PL9510	15.23	1.05	102.0	18	1.05	.256/.256/.122	M124
PL9232	890	0.40	2850	1000	0.41	.413/.413/.201	M122	PL9511	18.7	0.95	119.0	22	0.95	.256/.256/.122	M124
PL9301	0.62	7.60	5.5	0.68	10	.410/.410/.157	M120	PL9512	21.54	0.85	146.0	27	0.85	.256/.256/.122	M124
PL9302	1.2	7.10	7.3	1.3	8	.410/.410/.157	M120	PL9513	27.71	0.76	183.0	33	0.76	.256/.256/.122	M124
PL9303	1.9	5.80	10.9	2.2	6.15	.410/.410/.157	M120	PL9514	33.57	0.68	210.0	39	0.68	.256/.256/.122	M124
PL9304	2.8	5.20	13.3	3.3	5.8	.410/.410/.157	M120	PL9515	40.15	0.60	230.0	47	0.6	.256/.256/.122	M124
PL9305	4.0	4.70	19.6	4.7	5.4	.410/.410/.157	M120	PL9516	49.68	0.55	305.0	56	0.55	.256/.256/.122	M124
PL9306	5.4	3.70	27.0	6.0	4.5	.410/.410/.157	M120	PL9517	60.66	0.48	351.0	68	0.48	.256/.256/.122	M124
PL9307	6.9	3.50	30.8	7.6	4	.410/.410/.157	M120	PL9518	74.71	0.45	419.0	82	0.45	.256/.256/.122	M124
PL9308	8.0	3.40	33.2	10	3.8	.410/.410/.157	M120	PL9519	85.39	0.40	520.0	100	0.4	.256/.256/.122	M124
PL9309	11	3.00	45.2	12	3.4	.410/.410/.157	M120								
PL9310	12	2.80	49.4	15	3.1	.410/.410/.157	M120								
PL9311	19	2.30	77	22	2.8	.410/.410/.157	M120								
PL9312	25	2.10	89	27	2.3	.410/.410/.157	M120								
PL9313	38	1.65	142	47	2.1	.410/.410/.157	M120								
PL9314	55	1.32	212.0	68	1.5	.410/.410/.157	M120								
PL9315	83	1.10	328	100	1.35	.410/.410/.157	M120								
PL9316	123	0.88	500	150	1.15	.410/.410/.157	M120								
PL9317	178	0.73	739	220	0.92	.410/.410/.157	M120								
PL9318	278	0.60	1133	330	0.7	.410/.410/.157	M120								

1. The rated current as listed is either the saturation current or the heating current depending on which value is lower.
2. Parts can be ordered Non-Lead by adding "NL" to the part number (i.e. PL9514NL).
3. Optional Tape and Reel packaging can be ordered by adding a "T" suffix to the end of the part number (i.e. PL9514T).
4. Web: <http://www.pulseruggedized.com> home page, click on "PRODUCT FINDER" and enter the part number.



PLANARS POWER INDUCTORS

Electrical Specifications @ 25°C - Operating Temperature -40°C to +130°C

Part Number	Inductance @		DCR (mΩ)		Inductance @ 0 A dc (μH ±15%)	Saturation Current (ADC)		Heating Current (A)	Data Sheet
	Irated (μH ±15%)	Irated (ADC)	TYP	MAX		25°C	100°C		
2-Turn (Low Loss Series)									
PL10100	0.45	73	0.38	0.48	0.45	95	80	73	M194
PL10101	0.63	54	0.38	0.48	0.65	63	53	73	M194
PL10102	0.85	39	0.38	0.48	0.91	46	37	73	M194
PL10103	1.05	30	0.38	0.48	1.10	35	30	73	M194
PL10104	1.25	25	0.38	0.48	1.30	29	26	73	M194
PL10105	1.45	21	0.38	0.48	1.50	24	22	73	M194
2-Turn Series									
PL10106	0.45	52	0.78	0.98	0.45	95	80	52	M194
PL10107	0.63	52	0.78	0.98	0.65	63	53	52	M194
PL10108	0.85	39	0.78	0.98	0.91	46	37	52	M194
PL10109	1.05	30	0.78	0.98	1.10	35	30	52	M194
PL10110	1.25	25	0.78	0.98	1.30	29	26	52	M194
PL10111	1.45	21	0.78	0.98	1.50	24	22	52	M194
3-Turn Series									
PL10112	0.95	42	1.15	1.43	1.00	68	54	42	M194
PL10113	1.40	36	1.15	1.43	1.50	43	35	42	M194
PL10114	1.90	25	1.15	1.43	2.00	29	25	42	M194
PL10115	2.40	20	1.15	1.43	2.50	23	21	42	M194
PL10116	2.80	15	1.15	1.43	3.00	18	16	42	M194
PL10117	3.40	12	1.15	1.43	3.50	15	13	42	M194
4-Turn Series									
PL10118	1.60	37	1.44	1.80	1.60	55	43	37	M194
PL10119	2.40	30	1.44	1.80	2.42	35	27	37	M194
PL10120	3.30	17	1.44	1.80	3.60	20	18	37	M194
PL10121	4.00	14	1.44	1.80	4.40	16	15	37	M194
PL10122	4.90	11	1.44	1.80	5.34	13	12	37	M194
PL10123	5.80	9	1.44	1.80	6.20	11	10	37	M194

HIGH FREQUENCY PLANAR TRANSFORMERS

Electrical Specifications @ 25°C - Operating Temperature -40°C to +130°C

Part Number	Turns Ratio		Primary Inductance (μH MIN)	Leakage Inductance (μH MIN)	DCR (mΩ MAX)			Datasheet
	Primary	Secondary			Primary A	Primary B	Secondary	
PL10201	4T & 4T	1T:1T:1T:1T	216	0.3	13	13	4.5	M343
PL10203	5T & 5T	1T:1T:1T:1T	340	0.3	15	15	4.5	M343
PL10205	6T & 6T	1T:1T:1T:1T	480	0.3	21	21	4.5	M343
PL10207	7T & 7T	1T:1T:1T:1T	660	0.3	50	50	4.5	M343
PL10208	4T & 4T	1T & 1T	216	0.3	13	13	4.5	M343
PL10209	8T & 8T	1T:1T:1T:1T	860	0.3	60	60	4.5	M343
PL10210	5T & 5T (w/ 5T aux)	1T & 1T	340	0.3	15	15	0.56 & 0.56	M343
PL10212	6T & 6T (w/2T aux)	1T & 1T	480	0.3	21	21	0.56 & 0.56	M343
PL10214	7T & 7T (w/3T aux)	1T & 1T	660	0.3	50	50	0.56 & 0.56	M343
PL10216	8T & 8T	1T & 1T	860	0.3	60	60	0.56 & 0.56	M343



Weight..... 10.8 grams MAX
Tape & Reel..... 250/reel

Dimensions: Inches
mm
Unless otherwise specified,
all tolerances are ± .010
0.25



NOTES:

1. Optional Tape and Reel packaging can be ordered by adding a "T" suffix to the end of the part number (i.e. PL10123T).
2. Parts can be ordered Non-Lead by adding "NL" to the part number (i.e. PL10123NL).
3. Web: <http://www.pulseruggedized.com> home page, click on "PRODUCT FINDER" and enter the part number.

HIGH FREQUENCY PLANAR TRANSFORMERS

Electrical Specifications @ 25°C - Operating Temperature -40°C to +130°C - Power Rating Up To 250W

Part Number	Turns Ratio		Primary Inductance (µH MIN)	Leakage Inductance	DCR (mΩ MAX)		Data Sheet
	Primary A	Primary B			Primary A	Primary B	
PL10230	4T	1T:1T:1T:1T	54	0.3	13	-	M343
PL10231	5T (w/5T aux)	1T:1T:1T:1T	85	0.3	15	470	M343
PL10232	6T (w/2T aux)	1T:1T:1T:1T	120	0.3	21	156	M343
PL10233	7T (w/3T aux)	1T:1T:1T:1T	165	0.3	50	200	M343
PL10234	4T	7T & 7T	54	0.3	13	-	M343
PL10235	5T (w/5T aux)	7T & 7T	85	0.3	15	470	M343
PL10236	6T (w/2T aux)	7T & 7T	120	0.3	21	156	M343
PL10237	7T (w/3T aux)	7T & 7T	165	0.3	50	200	M343
PL10238	4T	1T & 1T	54	0.3	13	-	M343
PL10239	5T (w/5T aux)	1T & 1T	85	0.3	15	470	M343
PL10240	6T (w/2T aux)	1T & 1T	120	0.3	21	156	M343
PL10241	7T (w/3T aux)	1T & 1T	165	0.3	50	200	M343
PL10242	4T	2T & 1T	54	0.3	13	-	M343
PL10243	5T (w/5T aux)	2T & 1T	85	0.3	15	470	M343
PL10244	6T (w/2T aux)	2T & 1T	120	0.3	21	156	M343
PL10245	7T (w/3T aux)	2T & 1T	165	0.3	50	200	M343
PL10246	8T	1T:1T:1T:1T	215	0.3	60	-	M343
PL10247	8T	2T & 1T	215	0.3	60	-	M343
PL10248	8T	1T & 1T	215	0.3	60	-	M343
PL10249	8T	2T & 1T	215	0.3	60	-	M343
PL10301	4T	5T	153	0.45	17.5	17.5	M314
PL10302	4T	5T	194	0.45	17.5	20	M314
PL10303	5T	5T	240	0.55	20	20	M314
PL10304	5T	6T	290	0.60	20	25	M314
PL10305	6T	6T	345	0.65	25	25	M314
PL10306	4T	4T	153	0.4	17.5	7.5	M314
PL10307	4T	5T	194	0.4	17.5	20	M314
PL10308	5T	5T	240	0.5	20	20	M314
PL10309	5T	6T	290	0.6	20	25	M314
PL10310	6T	6T	345	0.6	25	25	M314
PL10311	4T	4T	153	0.4	17.5	17.5	M314
PL10312	4T	5T	194	0.4	17.5	20	M314
PL10313	5T	5T	240	0.4	20	20	M314
PL10314	5T	5T	290	0.5	20	25	M314
PL10315	6T	6T	345	0.5	25	25	M314
PL10401	4T & 4T	1T:1T:1T:1T	211	0.3	6.8	6.8	M380
PL10402	5T & 5T	1T:1T:1T:1T	330	0.4	8.5	8.5	M380
PL10403	6T & 6T	1T:1T:1T:1T	423	0.6	10.2	10.2	M380
PL10404	7T & 7T	1T:1T:1T:1T	588	0.8	11.8	11.8	M380
PL10405	4T & 4T	1T:1T:1T:1T	768	1.2	13.4	13.4	M380
PL10406	8T & 8T	1T & 1T	216	0.45	6.8	6.8	M380
PL10407	5T & 5T	1T & 1T	340	0.84	8.5	8.5	M380
PL10408	6T & 6T	1T & 1T	480	1.0	10.2	10.2	M380
PL10409	7T & 7T	1T & 1T	660	1.2	11.8	11.8	M380
PL10410	8T & 8T	1T & 1T	860	1.7	13.4	13.4	M380

NOTES:

1. Optional Tape and Reel packaging can be ordered by adding a "T" suffix to the end of the part number (i.e. PL10123T).
2. Parts can be ordered Non-Lead by adding "NL" to the part number (i.e. PL10123NL).
3. Web: <http://www.pulseruggedized.com> home page, click on "PRODUCT FINDER" and enter the part number.

SMT CURRENT SENSE TRANSFORMERS

Height: 5.5mm Max

Footprint: 8.4mm x 7.2mm Max

Frequency Range: 50kHz to 1MHz

Electrical Specifications @ 25°C — Operating Temperature -55°C to +130°C

Part Number	Turns Ratio	Current * Rating (A)	Secondary Inductance (mH MIN)	DCR (mΩ MAX)		Hipot (VDC)	Data Sheet
				Primary (8-7)	Secondary (1-3)		
PL3250	1:20	10	0.08	6	550	700	M278
PL3251	1:30	10	0.18	6	870	700	M278
PL3252	1:40	10	0.32	6	1140	700	M278
PL3253	1:50	10	0.50	6	1500	700	M278
PL3254	1:60	10	0.72	6	2250	700	M278
PL3255	1:70	10	0.98	6	4750	700	M278
PL3256	1:100	10	2.00	6	5500	500	M278
PL3257	1:125	10	3.00	6	6500	500	M278

SMT CURRENT SENSE TRANSFORMERS

Electrical Specifications @ 25°C — Operating Temperature -55°C to +130°C

Part Number	Turns Ratio	Current * Rating (A)	Secondary Inductance (mH MIN)	DCR (mΩ MAX)		Hipot (Vrms)	Data Sheet
				Primary (8-7)	Secondary (1-3)		
PL3258	1:20	20	0.08	0.75	550	1000	M279
PL3259	1:30	20	0.18	0.75	870	1000	M279
PL3260	1:40	20	0.32	0.75	1140	1000	M279
PL3261	1:50	20	0.50	0.75	1500	1000	M279
PL3262	1:60	20	0.72	0.75	2500	1000	M279
PL3263	1:70	20	0.98	0.75	4750	1000	M279
PL3264	1:100	20	2.00	0.75	6000	1000	M279
PL3265	1:125	20	3.00	0.75	7700	700	M279
PL3479	1:200	20	8.00	0.75	17000	700	M279

AUDIO TRANSFORMERS

Electrical Specifications @ 25°C — Operating Temperature -55°C to +130°C

Part Number	Primary Impedance 1KHz/1.0 Vrms	Turns Ratio Pri: Sec +/-2%	Inductance (mH MAX)	DCR (mΩ MAX)	Hipot (Vrms)	Datasheet
PL3141	150	1:1	1.5	55/70	1500	M358
PL3183	150	1:1	1.5	12/14	1250	M508

1. Parts can be ordered Non-Lead by adding "NL" to the part number (i.e. PL3250NL).
2. For Tape & Reel packaging, add the suffix "TT" to the part number when ordering (i.e. PL3250NLT).
3. Web: <http://www.pulseruggedized.com> home page and enter the part number on the search bar.

SMT CURRENT SENSE TRANSFORMER

Electrical Specifications @25°C - Operating Temperature -55°C to +130°C

Part Number	Turns Ratio	Current Rating (A)	Secondary Inductance (mH MIN)	DCR Primary (1,3-2,4) (mΩ MAX)	DCR Secondary (5-6) (mΩ MAX)	Hipot (Vrms)	Package L/W/H (in.)	Datasheet
PL1961	1:1:200	15.00	59.200	2.3	4200	500	.575 / .495 / .280	M150



GATE DRIVE TRANSFORMERS

1000Vdc -1500Vdc Basic & Functional Insulation

Part Number	Turns Ratio	Pri-Sec Insulation	MAX (v*usec)	Primary Inductance (µH MAX)	Leakage Inductance (µH MAX)	DCR Primary (Ω MAX)	DCR Secondary (Ω MAX)	Package L/W/H (in.)	Insulation	Datasheet
PL3172NL	1:1	1500 Vrms	9.7	1200.0	.50	.91	.91	.355/.340/.300	FUNCTIONAL	M297
PL1960	1:1	1500Vdc	9.7	785.0	.46	.60	.60	.265/.340/.140	FUNCTIONAL	M149
PL3280	1:1:1	1500Vrms	12.7	800.0	.65	.75	.75	.340/.265/.140	FUNCTIONAL	M296
X-1569NL	1:1:1	1500Vdc	45.1	3330.0	.700	1.60	1.60	.355/.340/.300	FUNCTIONAL	M258
X-1622NL	1:1:1	1500Vrms	60.0	1400.0	1.50	1.60	1.5/1.5	.355/.340/.300	FUNCTIONAL	M295
PL3057NL	2.5:1:1	1500Vrms	27.2	1200.0	.80	.91	.38/.38	.355/.340/.300	BASIC	M294
PL2973	1:1	1500Vdc	27.2	1200	0.50	.91	.91	.355/.340/.300	BASIC	M299
PL3140	2:1:1	1500Vrms	/	1200	0.60	.91	.46	.355/.340/.300	FUNCTIONAL	M383
PL3002	1:1:1	1600Vrms	866	5000	80	6	7.2/7.2	0.75/0.75/0.50	FUNCTIONAL	M386
PL2148NL	1:1	1500Vrms	55	1486	0.80	1.15	1.15	.355/.340/.300	FUNCTIONAL	M387
PL3159	1:1:1	2700Vdc	21	507	0.4	0.85	.85/.85	.315/.200/.118	FUNCTIONAL	M388
PL3212NL	1:1:1	3000Vrms	95	450	.50	0.08	.072	.810/.750/.480	BASIC	M389
PL3215NL	1:1:1	6000Vrms	115	686	.80	0.71	.71/0.71	.750/.810/.480	BASIC	M394
PL3445NL	1:1:1	1500Vrms	85	7200	2.0	3.0	3/3	.355/.340/.300	FUNCTIONAL	M395
PL3602NL	2:1:1	4000 Vrms	375	1500	8.0	2.2	1.6/1.6	.650/.500/.599	FUNCTIONAL	M396
PL3716	1:1	700Vrms	126	2500	4.0	5.8	6.2	.650/.443/.400	FUNCTIONAL	M392
PL3839NL	1:1:1	2500Vrms	48	1500	TBD	1.5	1.5/1.5	.572/.512/.340	FUNCTIONAL	M393
PL3840	1:1	10KVrms	320	1850	15	0.133	0.12/.085	1.319/1.417/.728	FUNCTIONAL	M397
PL1863	2:1:1	2500Vdc	27.2	1200	.60	0.91	.46/.46	.355/.340/.300	FUNCTIONAL	M398
PL1903	1:1	1500Vrms	15.4	750	0.75	0.88	0.7	.470/.350/.160	BASIC	M410
PL2064	1:2.5:2.5	3750Vrms	10.88	162	0.24	0.28	.56/.56	.665/.421/.267	BASIC	M412
PL2072	1:1	1500Vrms	12	403.2	0.46	0.685	.685	.345/.265/.098	FUNCTIONAL	M367
10B-1002	1:1	700Vrms	24	10,000	30	11	11	.650/.443/.440	FUNCTIONAL	M464
PL2077NL	1:1:1	1650Vrms	28	.84	.75	1.05	1.05	.470/.350/.160	FUNCTIONAL	M413

1. The maximum volt-µsec rating limits the peak flux density to 2200 Gauss when used in a unipolar drive application. For bi-polar drive applications a maximum volt-µsec of two times this rating is acceptable (ie: 2* (volt*µsec rating) Volt*µsec = (voltage applied to the primary) * dutycycle / Frequency = V * alpha / Freq_Hz = V * µsec
2. Leakage inductance is measured at primary terminals with all secondaries shorted.
3. Optional Tape & Reel packaging can be ordered by adding a "T" suffix to the end of the part number (i.e. PL1960T).
4. The "NL" suffix indicates an RoHS-compliant part number. Non-NL suffixed parts are not necessarily RoHS compliant, but are electrically and mechanically equivalent to NL versions.
5. The temperature of the component (ambient plus temperature rise) must be within the stated operating temperature range.
6. Web: <http://www.pulseruggedized.com> home page and enter the part number on the search bar.



CUSTOM CAPABILITIES

Space Development/Testing/Validation Capabilities

- MIL-STD-981
- NASA EEE-INST-002
- NASA-STD 8739.3
- IPC-STD-001DS
- MIL-PRF-21038
- MIL-PRF-27
- MIL-STD-202
- ECSS-Q-ST-70-38C
- AEC-Q200
- MIL-STD-883
- Custom Power
- Signal Design/Build

Program Participation

Orion World View III MagEIS HPCA STARMU Advanced Composition Explorer (ACE)
 GPS III James Webb Telescope International Space Station GBD

Manufacturing Capabilities

Bobbin Winding	Toroid Winding	AS9100D Quality System
SMT Board Assembly	Elected/Mechanical Assembly	Harness Assembly
In-House Machine Shop	Automated Electrical Test	Transfer Molding
Custom Lead Forming	E.S.S. Capability	Vaccum Encapsulation / Impregnation
	Automated Solder Tinning	

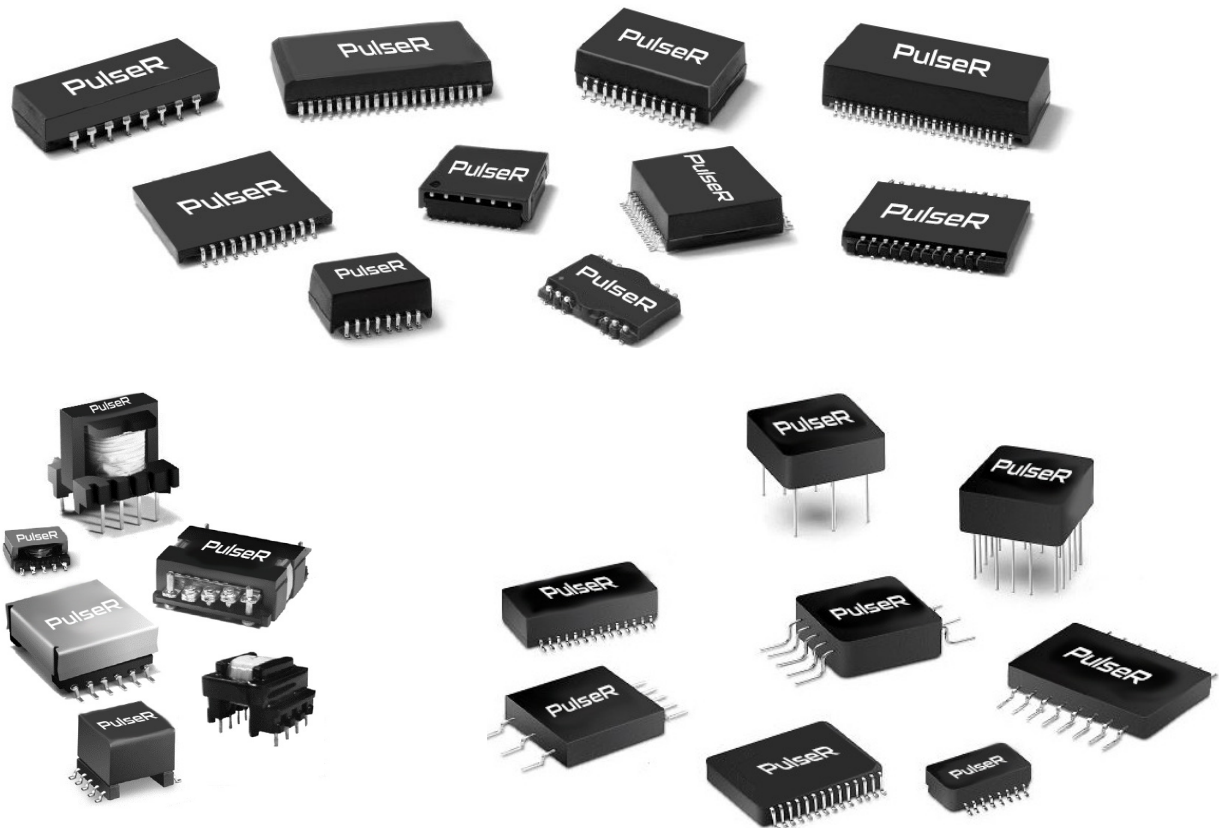

PulseR CUSTOM CAPABILITIES

CUSTOM CAPABILITIES (continued)

Product Capability	PACKAGING	MAXIMUM POWER	MAXIMUM CURRENT	FREQUENCY
SINGLE INDUCTORS	Lamination, Toroidal, Tape Wound	4KVA		15- 2MHz
COMMON MODE CHOKES 1/3 Phase	Lamination, Toroidal, Tape Wound		500A	15 - 2400Hz
CHOKES 3 PHASE (LINE FILTERING)	Lamination, Tape Wound		500A	15 - 2400Hz
POWER TRANSFORMERS 1 Phase	Lamination, Toroidal, Tape Wound	10KVA		15 - 1200Hz
TRANSFORMERS Laminated 3 Phase	Lamination, Toroidal, Tape Wound	10KVA		15 - 1200Hz
TRANSFORMERS - Switchmode	Planar, Bobbin Wound, Toroidal	1KVA		20K- 1MHz
INDUCTORS - Switchmode Buck/Boost	Toroidal, Bobbin Wound	500VA		20K- 1MHz
TRANSFORMERS - Current Sense	Toroidal, Bobbin Wound	4KVA (burden)		15- 1MHz
TRANSFORMER MODULES -Current Sense 1/3 PHASE	Toroidal, Bobbin Wound	4KVA (burden)		15- 1MHz
TRANSFORMERS Gate Drive	Toroidal, Bobbin Wound			20KHz- 1MHz
CURRENT SENSE TRANSFORMERS	Lamination, Toroidal, Tape Wound	10KVA		15 - 1200Hz

Note: Magnetics for high temp requirement at +200°C

Testing Services

Testing capabilities for product qualification and design validation

ELECTRICAL

- Inductance with or without DC
- Turns Ratio
- HI-POT - Vac up to 5kv, Vdc up to 6kV
- Insulation Resistance
- Distortion
- Pulse Testing
- Thermal Rise
- Impedance
- Q (up to 1 Mhz)
- DCR
- SRF (up to 3Ghz)
- Leakage Inductance
- Voltage Ratio
- Insertion Loss

MECHANICAL

- Mechanical Shock
- Mechanical Vibration
- Solderability
- Resistance to Soldering Heat

ENVIRONMENTAL

- Humidity (to 90% RH)
- Moisture Resistance
- Thermal Shock
- Thermal Cycling
- High/Low Temperature Storage
- Steam Aging

ANALYTICAL

- 3D Real Time X-ray
- Plating composition analysis
- Detailed Inspection Plans
- First Article Inspection to AS9102

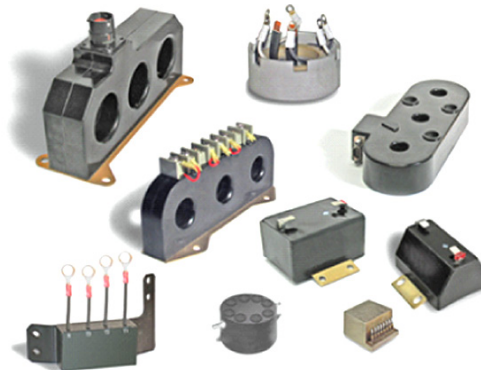
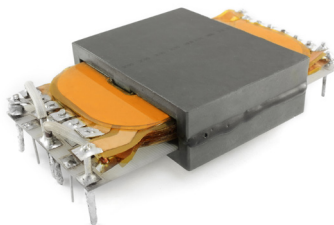

Inductor Design Worksheet

Contact

Name: _____ Company: _____
E-mail: _____ Phone: _____

Electrical

- Common Mode Differential Mode
 PFC Resonant

For PFC inductor only, please specify RMS current at 100-120Hz: _____

And peak to peak current for operation frequency: _____

	Winding 1	Winding 2	Winding 3
Inductance Range:	_____	_____	_____
Rated Current:	_____	_____	_____
Ripple Current:	_____	_____	_____
Q(Quality factor if relevant):	_____	_____	_____
SRF(Self-resonant frequency if relevant) minimum:	_____		

Mechanical

Mounting type:
 Surface mount Through hole
Other: _____
Maximum size:
Length _____ Width _____ Height _____

Safety and environmental requirements

Dielectrical withstanding voltage: _____ DC RMS
Ambient temperature range (°C) : _____
Temperature rise, maximum (°C) : _____
Lead/terminal finish: tin/lead Pure tin
Other: _____

Other

Sample quantity: _____ Date needed: _____
EAU(Estimated annual quantity): _____
Production start date: _____
Budgetary target price (USD) : _____
Specific application for this product: _____
Program name: _____
Restricted/ITAR: Yes No

Power Transformer Design Worksheet

Contact

Name: _____ Company: _____
 E-mail: _____ Phone: _____

Electrical

Total output power of power supply: _____
 Switching frequency (kHz): _____
 Maximum Duty Cycle: _____

Topology

- | | | |
|---|--|---|
| <input type="checkbox"/> Flyback Continuous | <input type="checkbox"/> Flyback Discontinuous | <input type="checkbox"/> Two-switch forward |
| <input type="checkbox"/> Forward Converter | <input type="checkbox"/> Active clamp forward | <input type="checkbox"/> Full bridge |
| <input type="checkbox"/> Push pull | <input type="checkbox"/> Half bridge | |

Other: _____

Primary

Input voltage range: _____
 Desired inductance (if known): _____
 Turns ratio (if known): _____
 Input current (if known): _____
 other: _____

Secondary(ies)

	S1	S2	S3	S4	S5	S6
Output voltage:	_____	_____	_____	_____	_____	_____
Output current:	_____	_____	_____	_____	_____	_____
Diode drop:	_____	_____	_____	_____	_____	_____

Mechanical

Mounting type:
 Surface mount Through hole
 Other: _____
 Maximum size:
 Length _____ Width _____ Height _____

Safety and environmental requirements

Agency requirement: IEC _____ UL _____ CSA _____
 Insulation class: Functional Basic Supplementary Reinforced
 Dielectrical withstanding voltage: _____ DC RMS
 Ambient temperature range (°C) : _____
 Temperature rise, maximum (°C) : _____
 Lead/terminal finish: tin/lead Pure tin
 Other: _____

Other

Sample quantity: _____ Date needed: _____
 EAU(Estimated annual quantity): _____
 Production start date: _____
 Budgetary target price (USD) : _____
 Specific application for this product: _____
 Program name: _____
 Restricted/ITAR: Yes No