

Doherty Combiner

Xinger[®]



Description:

The X3DC08E2S is a low profile, high performance Doherty Combiner in a new easy to use, manufacturing friendly surface mount package. The X3DC08E2S is designed particularly for Doherty Amplifier applications, where tightly controlled phase and amplitude imbalance as well as low insertion loss are required for maximum and low power condition. It can be used in high power applications up to 200 watts.

Parts have been subjected to rigorous qualification testing and they are manufactured using materials with coefficients of thermal expansion (CTE) compatible with common substrates such as FR4, G-10, RF-35, RO4350 and polyimide. Produced with 6 of 6 RoHS compliant tin immersion finish.

Features:

- 862 - 894 MHz
- High Power
- Low Amp Imbalance
- Very Low Loss
- Production Friendly
- Tape and Reel
- Lead Free

Electrical Specifications:

Frequency	Return Loss ^[1]	Insertion Loss ^[1]	Amplitude Imbalance ^[1]	Phase Imbalance ^[1]
MHz	dB Min	dB Max	dB Max	Degrees
862 – 894	20	0.15	±0.12	90 ± 3.0
Return Loss ^[2]	Insertion Loss ^[2]	Port Extension ^[3]	Power	Operating Temp.
dB Min	dB Max	Degrees	Avg. CW Watts	°C
20	0.25	0	200	-55 to +150

**Specification based on performance of unit properly installed on a TTM test board

[1] At maximum power condition, Doherty combiner functions as an equal-split power combiner.

[2] At low power condition, Doherty combiner functions as a 100Ω to 50Ω impedance transformer.

[3] There are short 50 ohm lines associated with input ports of 0° at 881MHz. Details in page 2

Mechanical Outline:

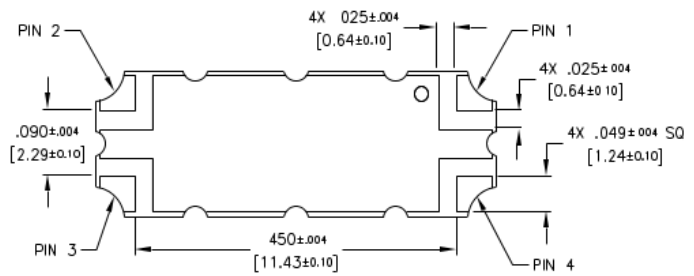
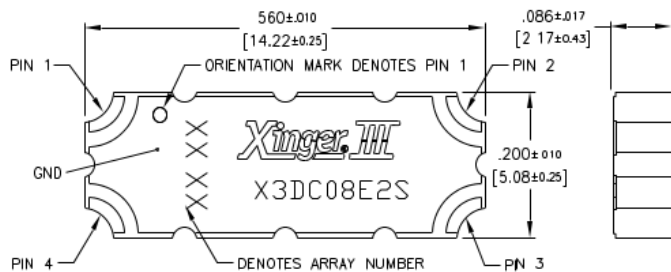

Dimensions are in Inches [Millimeters]
X3DC08E2S Mechanical Outline

Tolerances are Non-Cumulative

Doherty Amplifier Configuration

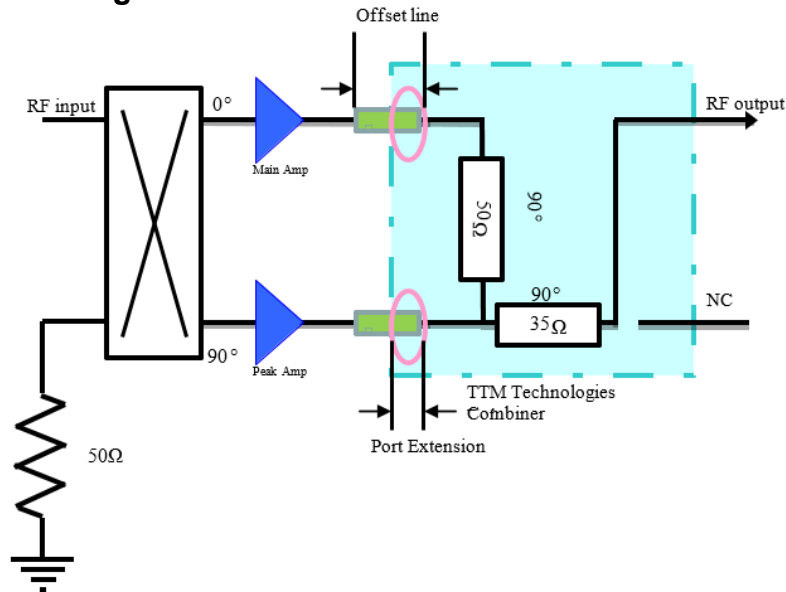

Doherty Combiner Pin Configuration

The X3DC08E2S has an orientation marker to denote Pin 1. Once port one has been identified the other ports are known automatically. Please see the chart below for clarification:

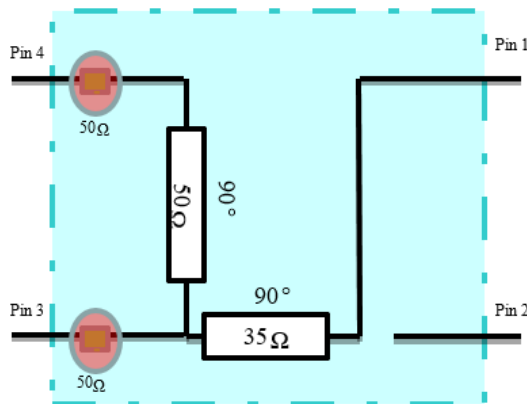

Pin 1	Pin 2	Pin 3	Pin 4
Combining Port	Not Used	Peak Amp Port	Main Amp Port

There are inevitably short lines associating with input ports in some high frequency band parts. The length of the short line is specified as electrical length at center frequency and noted as port extension in this datasheet. The designer should take this length into the consideration to optimize the offset line length.

Insertion Loss and Power Derating Curves

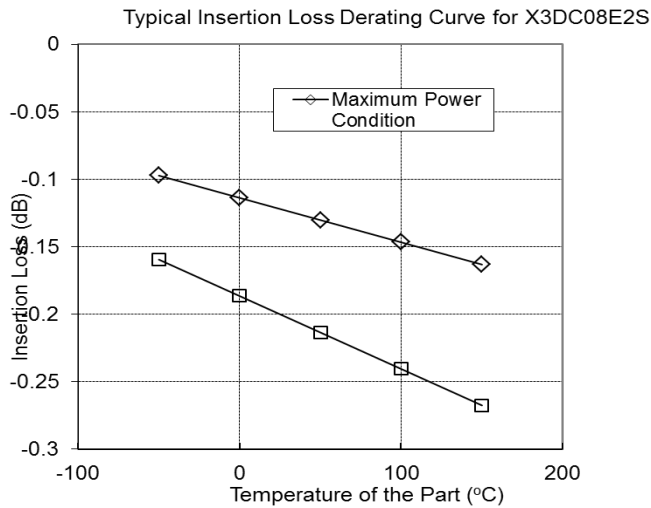

Insertion Loss Derating

The insertion loss, at a given frequency, of a group of Xinger parts is measured at 25°C and then averaged. The measurements are performed under small signal conditions (i.e. using a Vector Network Analyzer). The process is repeated at 85°C and 150°C. A best-fit line for the measured data is computed and then plotted from -55°C to 150°C.

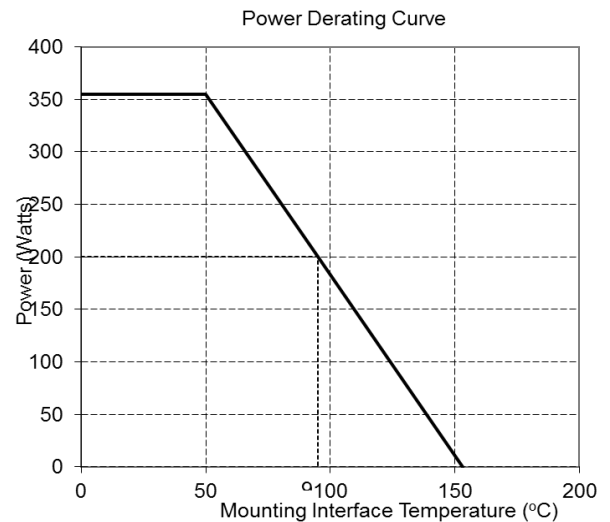

Power Derating

The power handling and corresponding power derating plots are a function of the thermal resistance, mounting surface temperature (base plate temperature), maximum continuous operating temperature of the coupler, and the thermal insertion loss. The thermal insertion loss is defined in the Power Handling section of the data sheet.

As the mounting interface temperature approaches the maximum continuous operating temperature, the power handling decreases to zero.

If mounting temperature is greater than 95°C, Xinger part will perform reliably as long as the input power is derated to the curve above.

Typical Performance (-55°C, 25°C, 95°C): 862-894 MHz

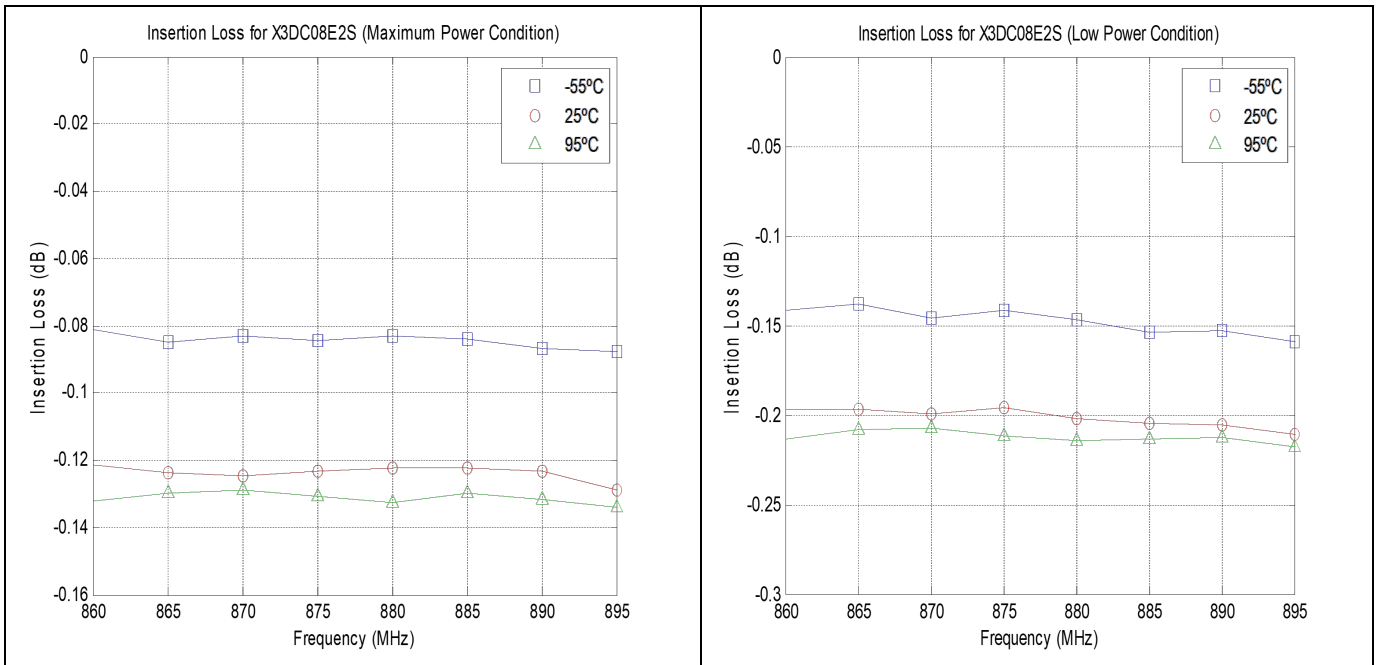
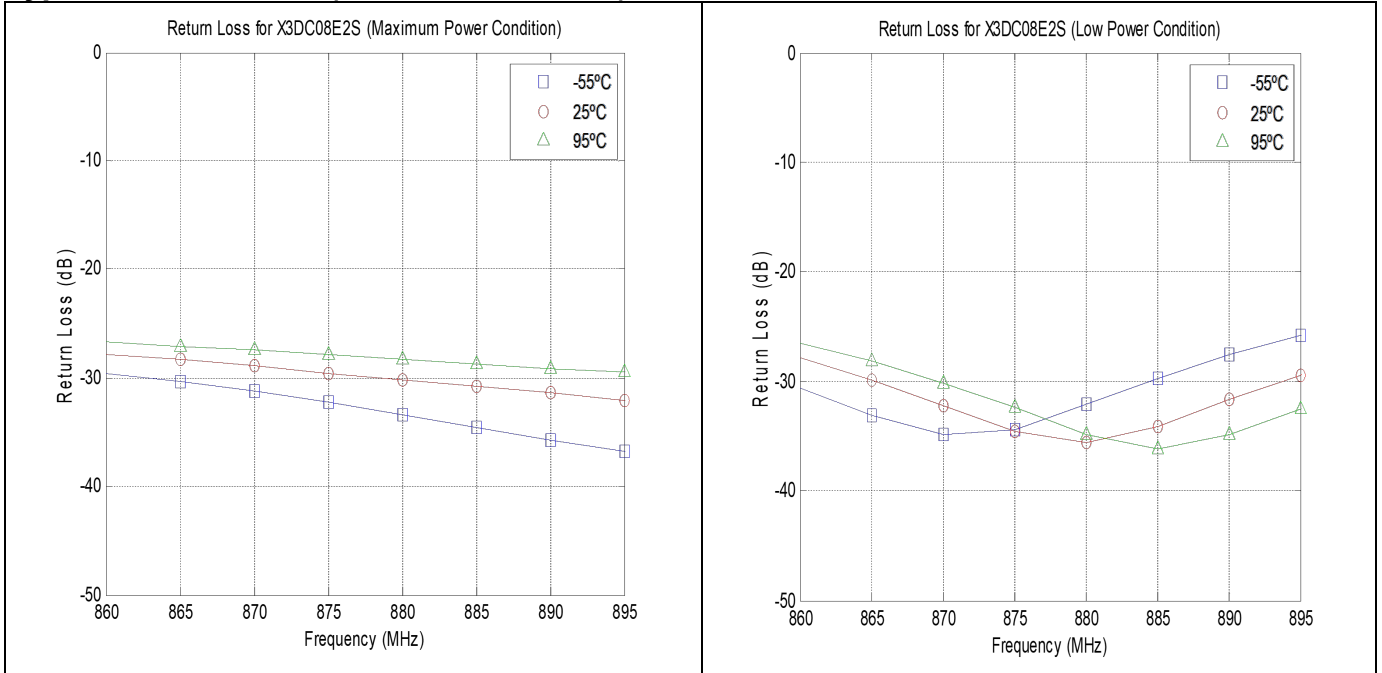

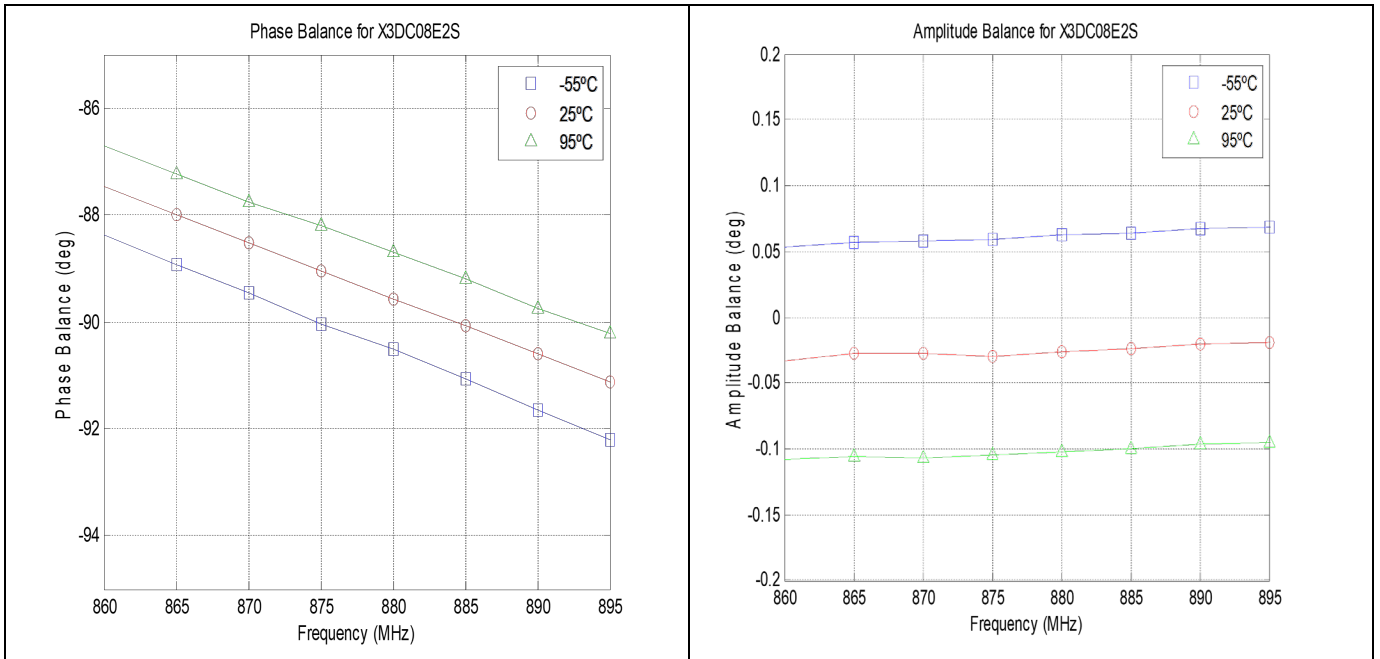

Definition of the Specifications

To guarantee the part performance in Doherty architecture, the part is specified in Doherty operation for maximum power condition and low power condition. The following specification definition assumes the extra port extension is already applied to the raw S parameter and the parts is measured with Pin n connected to Port n (where n=1, 2, 3, 4).

Maximum power condition

Under the maximum power condition, the symmetrical Doherty architecture requires main amplifier and peak amplifier to work at full capacity with the optimum termination (50 Ω). The two amplifiers should deliver RF power of equal magnitude and 90 degree phase difference. Doherty combiner functions as a coherent power combiner and supplies the 90 degree phase compensation. The following specification is defined with 50 Ω port impedance at three ports for this condition. The return loss and the insertion loss in max power mode are not affected by the 50 ohm lossless port rotation mentioned in electrical spec table in page 1. The phase imbalance and the amplitude imbalance are not affected either since port rotation are taken off equally from the main and the peak amp port.

Parameter	Definition	Mathematical Representation
Return Loss	The impedance match at the combining port to a 50Ω system.	$20\log S_{11} $
Insertion Loss	The combined power divided by the sum of input power under the perfect combining condition.	$10\log(S_{13} ^2 + S_{14} ^2)$
Phase Imbalance	The phase difference between Peak-Combined path and Main-Combined path at $\omega_c = 881\text{MHz}$	$\text{Phase}(S_{14}(\omega_c)) - \text{Phase}(S_{13}(\omega_c))$
Amplitude Imbalance	The magnitude difference between Peak-Combined path and Main-Combined path.	$\frac{1}{2}(20\log S_{14} - 20\log S_{13})$

Low power condition

Under low power condition, the Doherty operation turns off peak amplifier and requires main amplifier to be terminated with double of the optimum impedance (100 Ω). In this configuration, Doherty combiner servers as an impedance transformer transforming 50 Ω at combining port to 100 Ω at main amplifier port. The following specification is defined under the port impedance condition of Port 1 (Combining Port) 50 Ω, Port 4 (Main Amp Port) 100 Ω and Port 3 (Peak Amp Port) open. With the peak amp left off, the extra line length in that port (see figure in page 2) acts as an open stub which shifts the low power mode return loss null and insertion loss. The offset line length needs to be adjusted taking the port rotation number into consideration so that the junction of 50 Ω and 35 Ω transmission line sees high impedance instead of the part edge. The return loss and the insertion loss defined below are after the offset line adjustments specified in the spec tab

Parameter	Definition	Mathematical Representation
Return Loss	The impedance match of the 50 to 100 Ω transformer.	$20\log S_{11} $
Insertion Loss	The output power divided by input power.	$20\log S_{41} $