

TTM RF & Specialty Components Product & Technology Roadmap 2022



Mark Bowyer
Director, Business Development –
RF&S Business Unit
Mark.Bowyer@ttm.com

RF & Specialty Components (RF&S)

June 2022



Inspiring Innovation

TTM Corporate Overview



Aerospace & Defense/Specialty
(A&D) Business Unit



Automotive & Medical,
Industrial & Instrumentation
(AMI&I) Business Unit



RF & Specialty Components
(RF&S) Business Unit



Communications & Computing
(C&C) Business Unit

- TTM Technologies is a \$2.1B PCB manufacturer with ~20,000 employees globally
- RF&S (Anaren acquisition) operates as a stand alone TTM business unit
- We have been a provider of integrated microwave technology for over 50 years
- **Over 1.85 Billion components shipped to date**
- RF&S has 200 employees with our headquarters in Syracuse, NY
- Our core strategy is to provide highly innovative engineered solutions that create a differentiated competitive advantage

Main RF&S Engineering Locations

- BU Headquarter
- Engineering / R&D
- Customer Service
- Manufacturing of:
 - Xinger Products
 - Mini-Xinger



Syracuse, NY 40,000 sq. ft.

- Process Engineering
- Customer Service
- Manufacturing of:
 - Resistive Products
 - Ceramic Interposers



Suzhou, China 76,000 sq. ft.



Inspiring Innovation

Xinger® Standard Components – 5G sub-6GHz

TTM RF&S 5G Standard Products

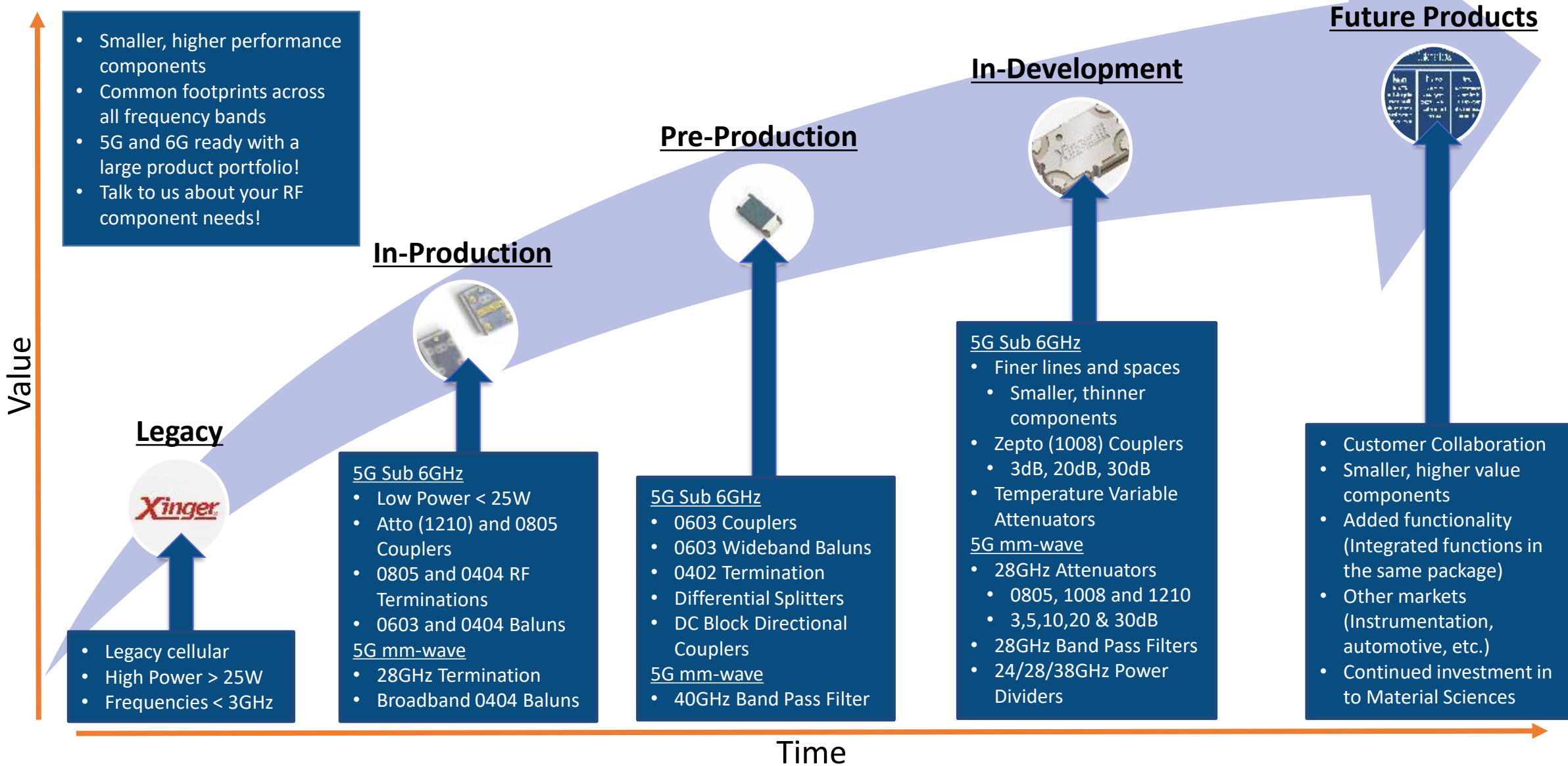

- Smaller, higher performance components
- Common footprints across all frequency bands
- 5G and 6G ready with a large product portfolio!
- Talk to us about your RF component needs!

Xinger® Families

- Designed for **high reliability** and **high volume** RF Applications
- Available in **all narrow bands** 100-6000MHz
- Part families are **Foot print compatible** across frequencies

Hybrid Couplers



Balun Transformers



Terminations

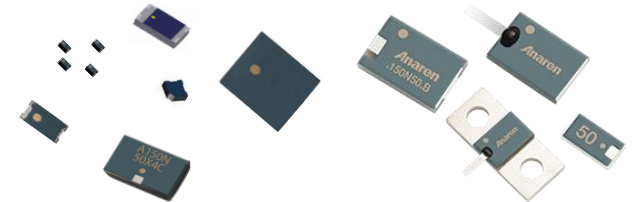

Directional Couplers

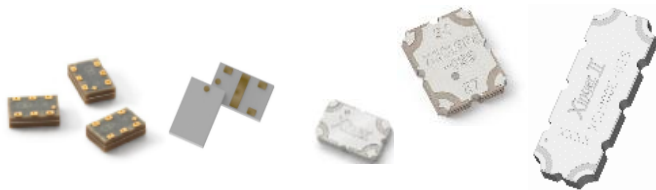

Power Dividers

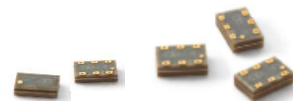

Attenuators

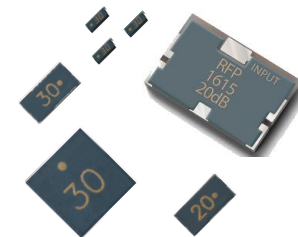

And many more...

Xinger® Standard Components

- Product Line **Xinger®**
- Off-the-shelf standard components
 - Couplers (Directional and 3dB Hybrids)
 - Power Dividers
 - Balun Transformers
 - Terminations
 - Attenuators

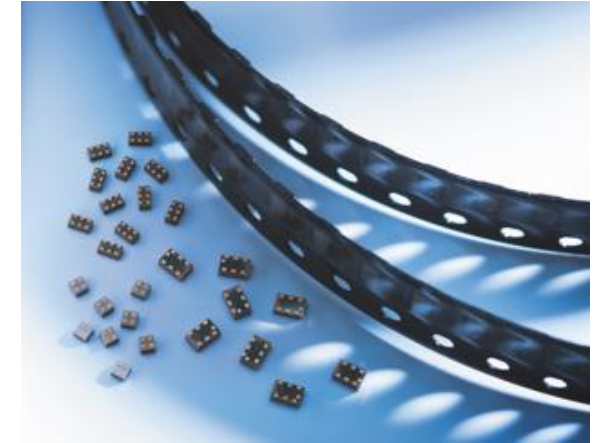
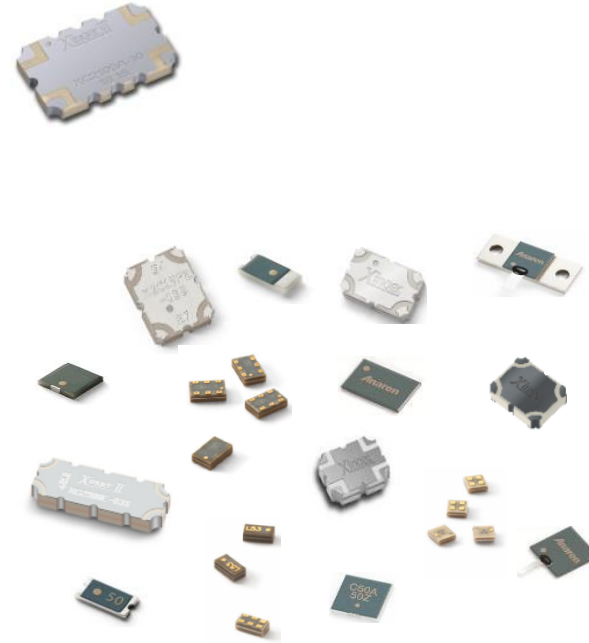

To keep up with 5G (smaller, more channels, lower power radios), we continue to innovate towards smaller, higher performing components



A-SIZE
14x10mm

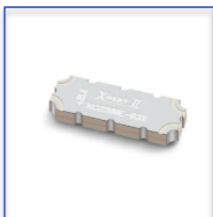

E-SIZE
14x5.1mm



Pico
6.4x5.1mm



Femto
3.2x5.1mm



Atto
3.0x2.5mm

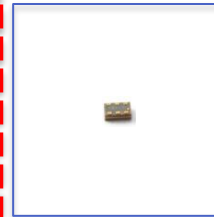

0805
2.0x1.3mm

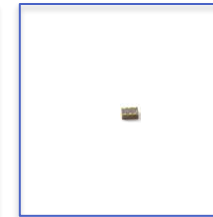

0603
1.5 x 0.75mm

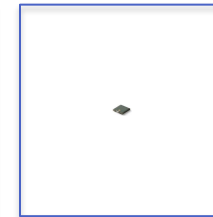

0404
1.0 x 1.0mm

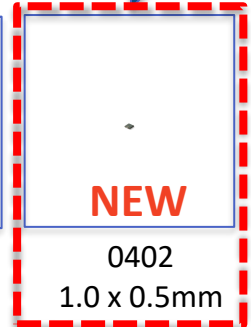

NEW Wideband 0603 Balun Family

Frequency (MHz)	50 to 50	50 to 100	50 to 200
600-2500	X4B10L1-5050G	X4BD10L1-50100G	X4BD10L1-50200G
1200-2700	X4B20L1-5050G	X4BD20L1-50100G	X4BD20L1-50200G
2300-6000	X4B40L1-5050G	X4BD40L1-50100G	X4BD40L1-50200G
3000-6000	X4BD40L1-5050G		

Please contact Mark Bowyer with any questions; mark.bowyer@ttm.com

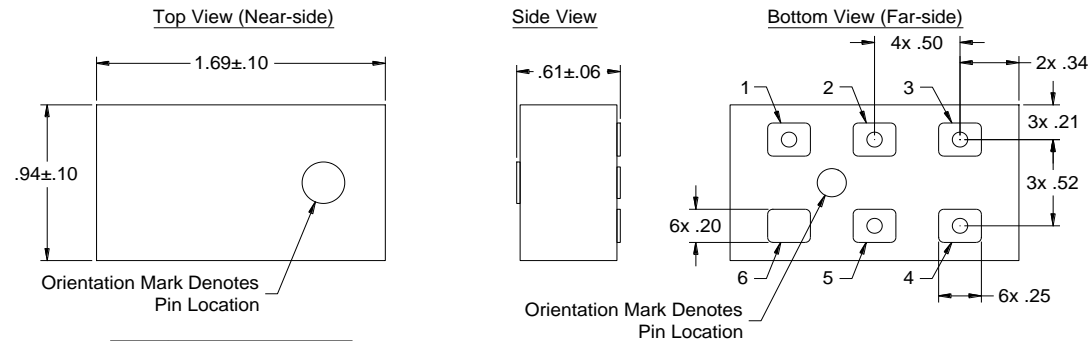

Pin	Designation
1	Unbalanced Port
2	NC
3	Balanced Port
4	Balanced Port
5	NC
6	GND

-Dimensions are in Millimeters
 -Tolerances are Non-Cumulative

NEW 0603 Coupler Family

****New for 2022****

Frequency (MHz)	2dB	3dB	4dB	5dB	20dB	30dB
1800-2300	X4C20L1-02G (3W)	X4C20L1-03G (3W)	X4C20L1-04G (3W)	X4C20L1-05G (3W)	X4C20L1-20G (7W)	X4C20L1-30G (7W)
2200-2800	X4C25L1-02G (3W)	X4C25L1-03G (3W)	X4C25L1-04G (3W)	X4C25L1-05G (3W)	X4C25L1-20G (7W)	X4C25L1-30G (7W)
3100-5100	X4C40L1-02G (3W)	X4C40L1-03G (3W)	X4C40L1-04G (3W)	X4C40L1-05G (3W)	X4C40L1-20G (7W)	X4C40L1-30G (7W)

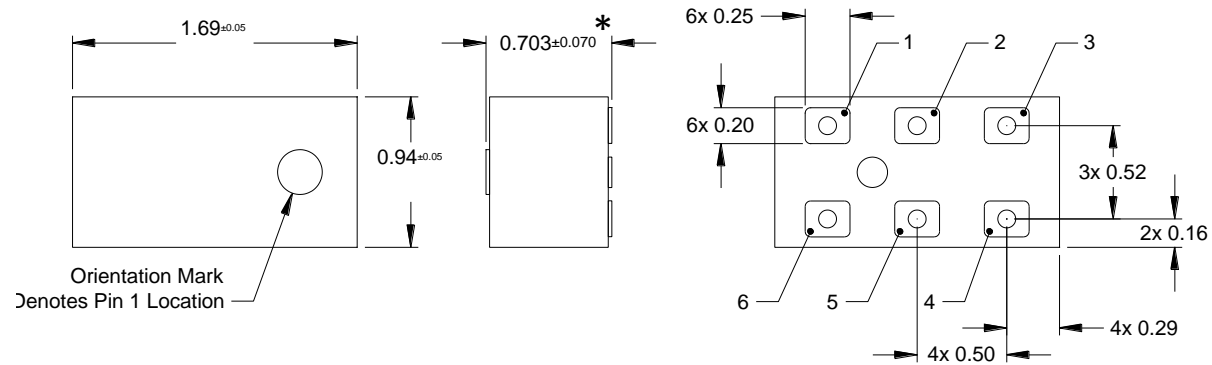

Dimensions are in Millimeters

Tolerances are Non-cumulative

Pin	Configuration-1	Configuration-2	Configuration-3	Configuration-4
1	Input	Isolated	Direct	Coupled
2	GND	GND	GND	GND
3	Isolated	Input	Coupled	Direct
4	Direct	Coupled	Input	Isolated
5	GND	GND	GND	GND
6	Coupled	Direct	Isolated	Input

*Thickness shown is an example only
Thickness is typically < 0.7mm

Please contact Mark Bowyer with any questions; mark.bowyer@ttm.com

NEW Xinger Zepto Family

	X5C20Z1-20S	X5C30Z1-20S	X5C40Z1-20S	X5C50Z1-20S
Frequency (MHz)	1700-2300	2300-3100	3100-4400	4400-5000
Mean Coupling (dB)	20±1	20±1	20±1	20±1
Return Loss (dB)	18	18	18	18
Directivity (dB)	18	18	18	18
Insertion Loss (dB)	0.10	0.10	0.10	0.10
Frequency Sensitivity (MHz)	±0.40	±0.40	±0.40	±0.40
Sample Availability	June 2022	Q3, 2022	Q3, 2022	Q3, 2022

Mechanical Outline

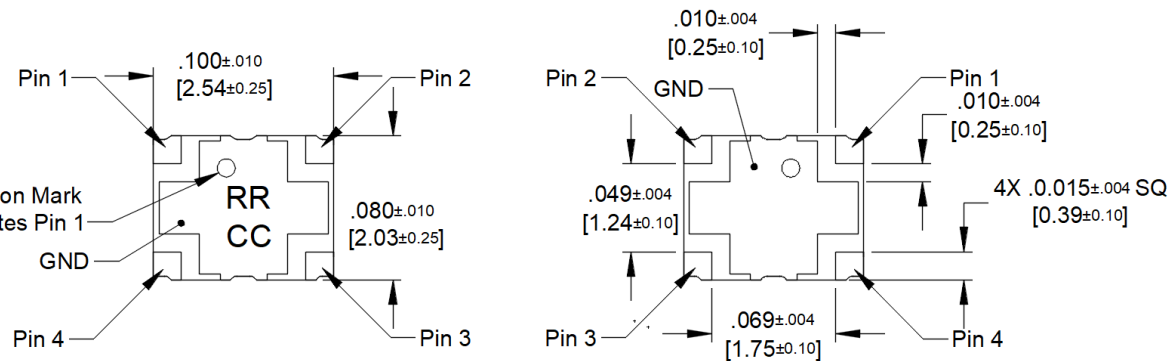

Dimensions are in Inches [Millimeters]

Pin Configuration

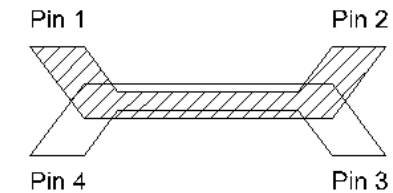

Pin 1	Pin 2	Pin 3	Pin 4
Input	Direct	Isolated	Coupled
Direct	Input	Coupled	Isolated

Please contact Mark Bowyer with any questions; mark.bowyer@ttm.com



Inspiring Innovation

Xinger[®] Standard Components – 5G mmWave

NEW 0603 Coupler Family

Frequency (GHz)	3dB Hybrid	Sample Availability	20dB Directional	Sample Availability
5.7 – 8.4	X4C70L1-03G	Q2, 2022	X4C70L1-20G	Q2, 2022
10.4 – 14.5	X4C120L1-03G	Q2, 2022	X4C120L1-20G	Q2, 2022

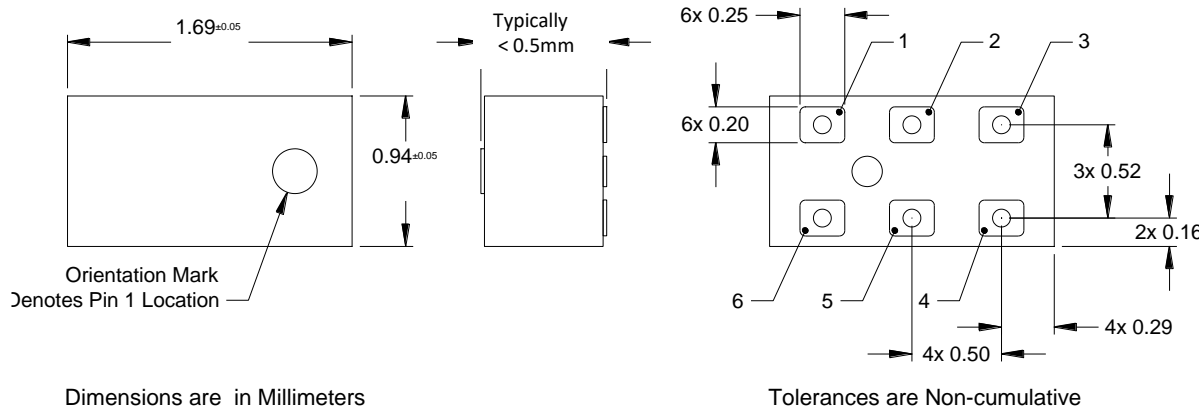

Pin	Configuration-1	Configuration-2	Configuration-3	Configuration-4
1	Input	Isolated	Direct	Coupled
2	GND	GND	GND	GND
3	Isolated	Input	Coupled	Direct
4	Direct	Coupled	Input	Isolated
5	GND	GND	GND	GND
6	Coupled	Direct	Isolated	Input

Specification (3dB Hybrid)	Target
Return Loss	18dB min
Insertion Loss	0.3dB max
Isolation	20dB min
Amplitude Balance	$\pm 0.5\text{dB}$ max
Phase Balance	90 ± 4 degrees
Power Handling (CW)	3W@105C

Specification (20dB Directional)	Target
Return Loss	18dB min
Insertion Loss	0.1dB max
Directivity	15dB min
Mean Coupling	$20.0 \pm 1\text{dB}$ max
Freq. Sensitivity	$\pm 0.30\text{dB}$ max
Power Handling (CW)	X4C120L1-20G 4W@105C X4C70L1-20G 5W@105C

Please contact Mark Bowyer with any questions; mark.bowyer@ttm.com

NEW Femto Couplers

Frequency (GHz)	3dB Hybrid	Sample Availability	20dB Directional	Sample Availability
5.5 – 8.5	X3C70F1-03S	Now	X3C70F1-20S	Now
8.0 – 12.0	X4C100F1-03S	Q2, 2022	X4C100F1-20S	Q2, 2022

Specification (X4C100F1-03S)	Target
Return Loss	18dB min
Insertion Loss	0.5dB max
Isolation	20dB min
Amplitude Balance	±0.5dB max
Phase Balance	90 ±5 degrees
Power Handling	20W @ 105C

Please contact Mark Bowyer with any questions; mark.bowyer@ttm.com

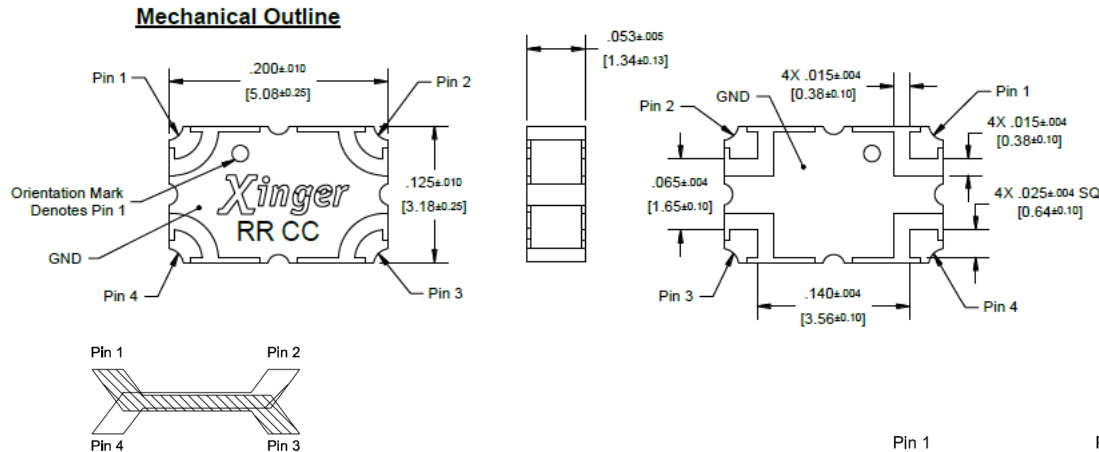

Specification (X4C100F1-20S)	Target
Return Loss	18dB min
Insertion Loss	0.5dB max
Directivity	20dB min
Mean Coupling	20.0 ±1dB max
Freq. Sensitivity	±0.50dB max
Power Handling	40W @ 105C

Configuration	Pin 1	Pin 2	Pin 3	Pin 4
Splitter	Input	Isolated	-3dB ∠θ -90	-3dB ∠θ
Splitter	Isolated	Input	-3dB ∠θ	-3dB ∠θ -90
Splitter	-3dB ∠θ -90	-3dB ∠θ	Input	Isolated
Splitter	-3dB ∠θ	-3dB ∠θ -90	Isolated	Input
*Combiner	A ∠θ -90	A ∠θ	Isolated	Output
*Combiner	A ∠θ	A ∠θ -90	Output	Isolated
*Combiner	Isolated	Output	A ∠θ -90	A ∠θ
*Combiner	Output	Isolated	A ∠θ	A ∠θ -90

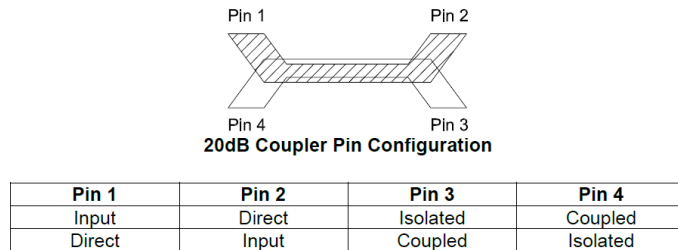

0404 mm-Wave Balun Family

Part Number	Low Freq (GHz)	High Freq (GHz)	UnBal Port (Ω)	Bal Port (Ω)	IL (dB)	RL (dB)	CMRR (dB)	Sample Availability
BD60120N50100AHF	5.9	11.7	50	100	1.0	12	20	NOW
BD120170N50100AHF	12.7	15.4	50	100	1.0	12	15	NOW
BD170240N50100AHF	17.7	23.6	50	100	1.5	12	15	NOW
BD240300N50100AHF	24	30	50	100	1.5	12	15	Q2, 2022

Top View (Near-side)

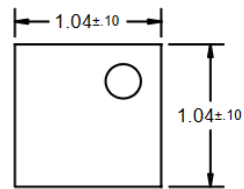

Side View

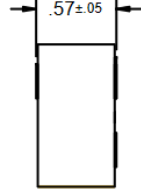

Bottom View (Far-side)

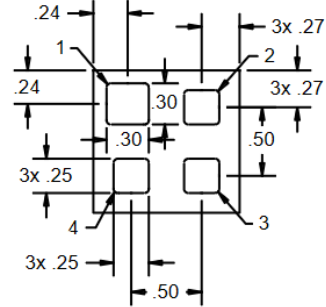

Dimensions are in Millimeters
Mechanical Outline

Pin	Designation
1	GND / DC Feed + RF GND
2	Unbalanced Port
3	Balanced Port
4	Balanced Port

Tolerances are Non-Cumulative

mmWave Band Pass Filter

Please contact Mark Bowyer with any questions; mark.bowyer@ttm.com

Config	Sample Availability	Passband						Reject Band			
		Freq		Ins loss		Return Loss		Attenuation <= 34.5 GHz		Attenuation 44.1 - 50 GHz	
		Min	Max	Typ	Max	Typ	Min	Typ	Min	Typ	Min
		GHz	GHz	dB	dB	dB	dB	dB	dB	dB	dB
4 pole	NOW	37	40	2	2.5	15	10	23	20	27	22
6 pole	NOW	37	40	3	3.5	15	10	43	36	43	36

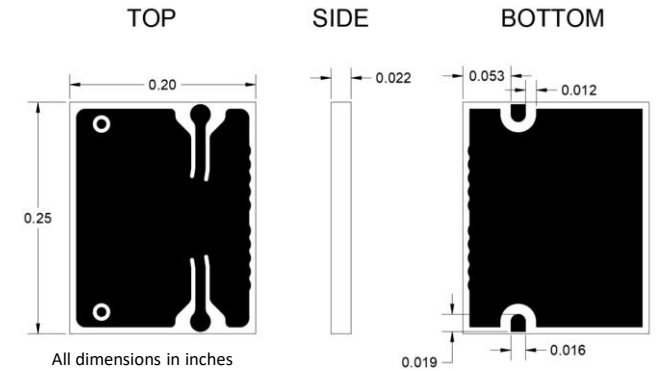

4 pole BPF Footprint

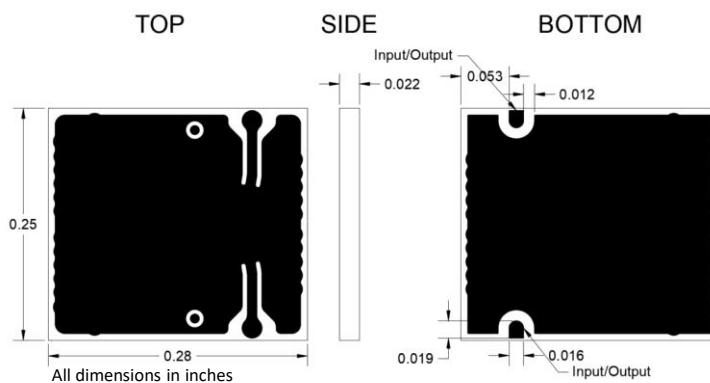

6 pole BPF Footprint

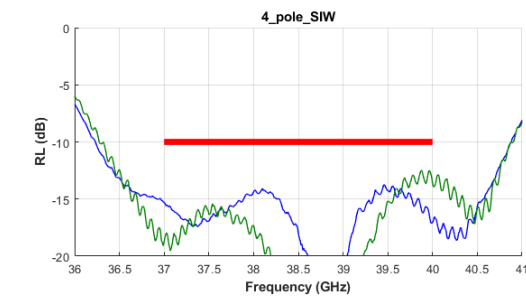
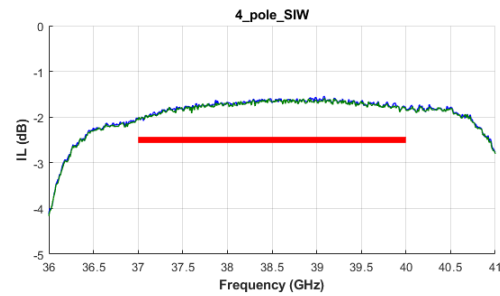
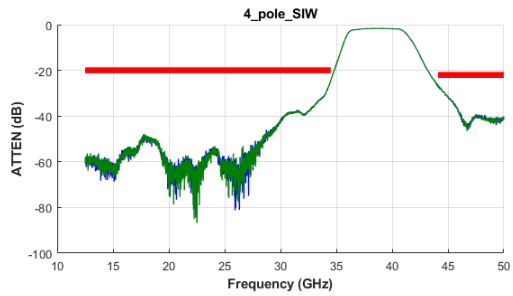
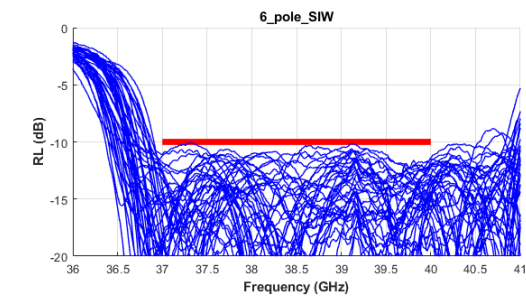
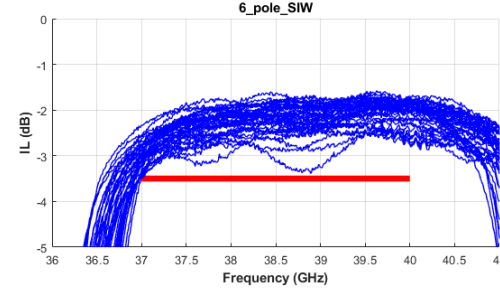
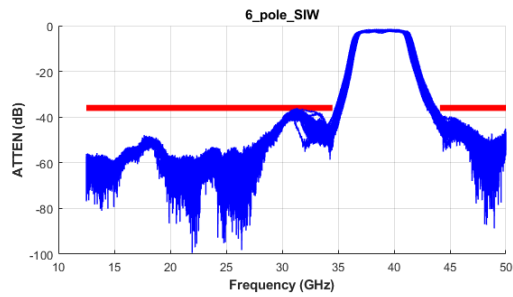

mmWave Power Divider

Please contact Mark Bowyer with any questions; mark.bowyer@ttm.com

Type	Sample Availability	Frequency Band (GHz)	Return Loss (dB)	Isolation (dB)	Insertion Loss (dB)	Amplitude Balance (dB)	Phase Balance (deg)
2 way	Q3, 2022	24 - 30	15	15	0.6	+/-0.3	+/-5
2 way	Q3, 2022	37 - 40	15	15	1	+/-0.6	+/-6
3 way	Q4, 2022	24.25 – 27.5	15	15	0.8	+/-0.7	+/-8
3 way	Q4, 2022	26.5 – 29.5	15	15	0.8	+/-0.7	+/-8
3 way	Q4, 2022	37 - 40	15	15	1.2	+/-0.9	+/-9

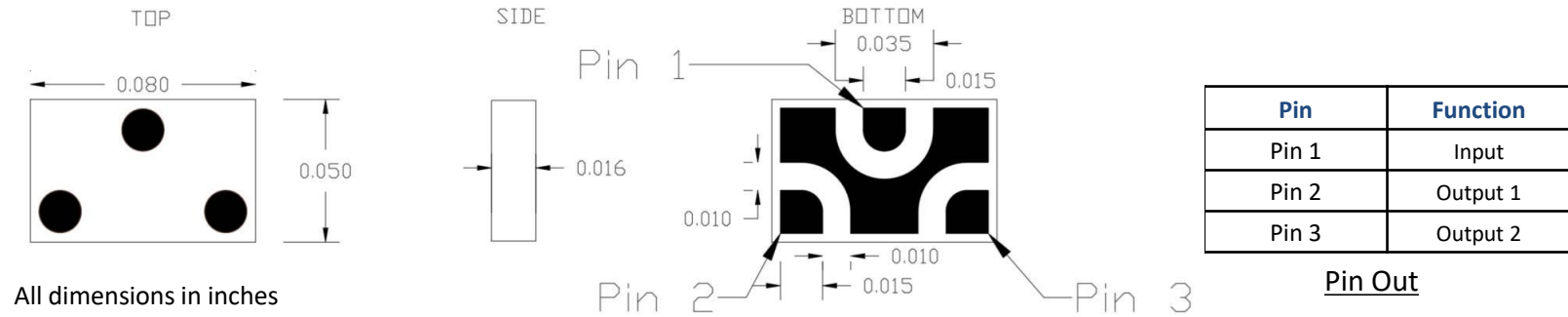

2 Way Power divider Footprint

mm-Wave High Power Termination 24 – 30GHz

Samples available

Mechanical Outline

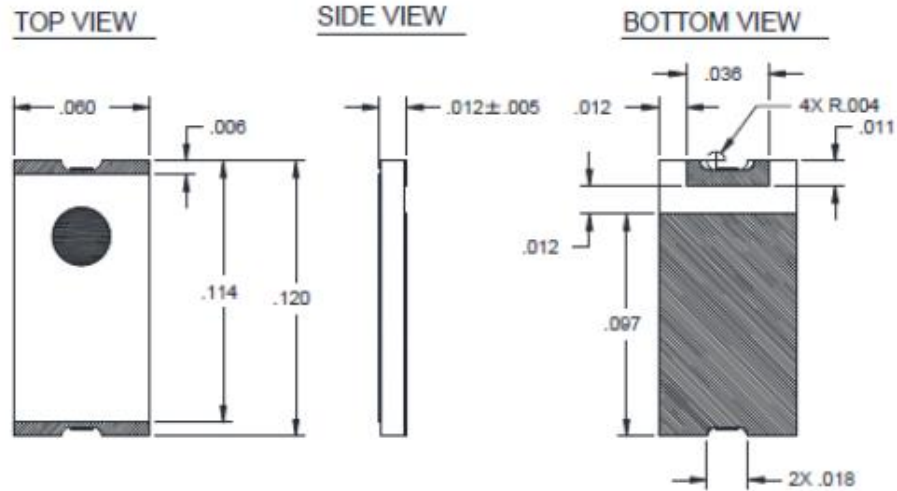

Simulated Performance

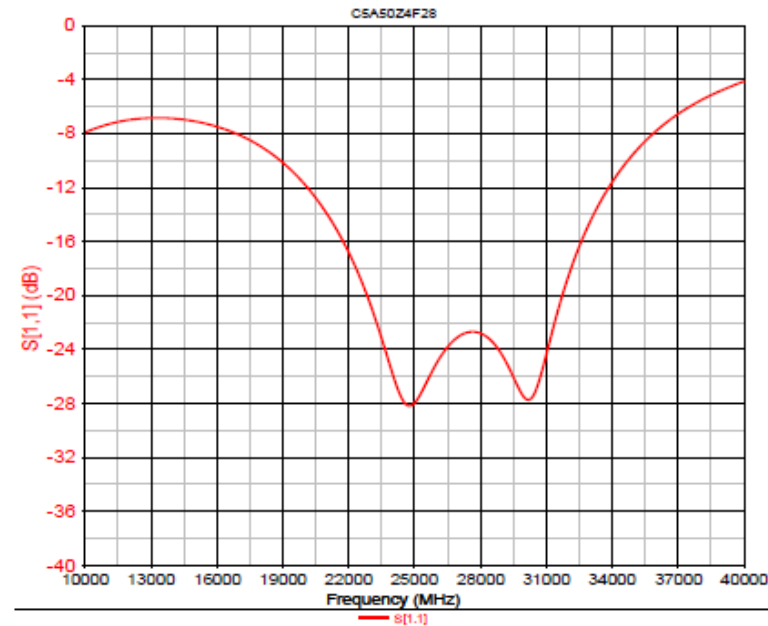

Electrical Specifications

Impedance:	50 Ohms
Power:	5 Watts
Return Loss	>18 dB (24 – 26GHz)
	>20 dB (26 – 30GHz)

Please contact Mark Bowyer with any questions; mark.bowyer@ttm.com

mm-Wave Termination DC – 81GHz

Please contact Mark Bowyer with any questions; mark.bowyer@ttm.com

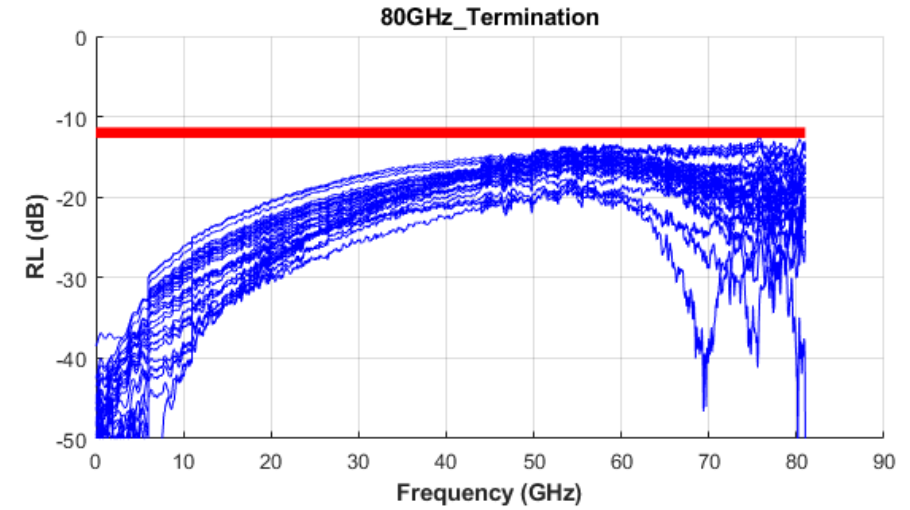
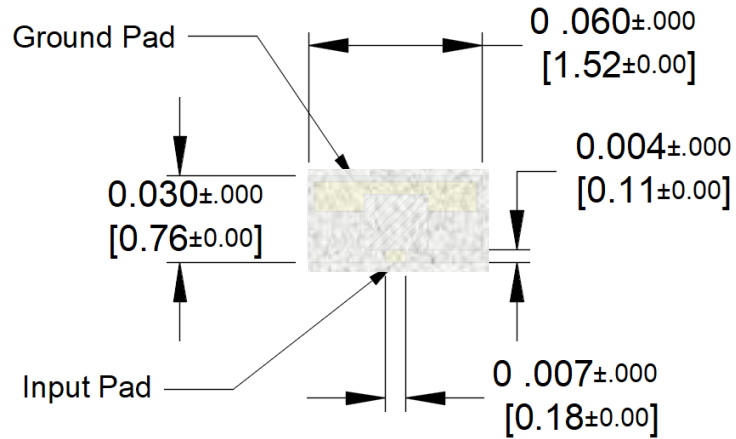

Dimensions are in inches [millimeters]

Typical return loss from DC to 81GHz (Red Spec line is at 12dB)

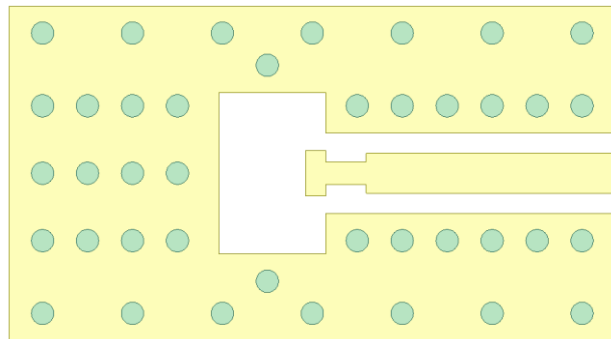

Test Board is 5mil RO3003

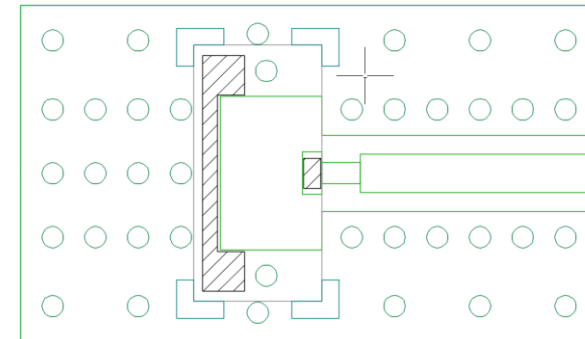
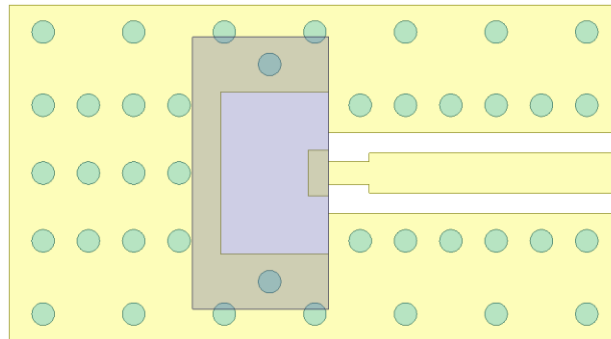

Hashed area show mounting footprint

mmWave Attenuators

Samples available

- Packages: 0805, 1008
- Frequency Band(s):
 - 1008 (24 – 30GHz)
 - 0805 (37 – 40GHz)
- Attenuation:
 - 5dB (In Development – Samples available)
 - 1dB, 3dB, 10dB (In Design)
- Power Handling: 1W

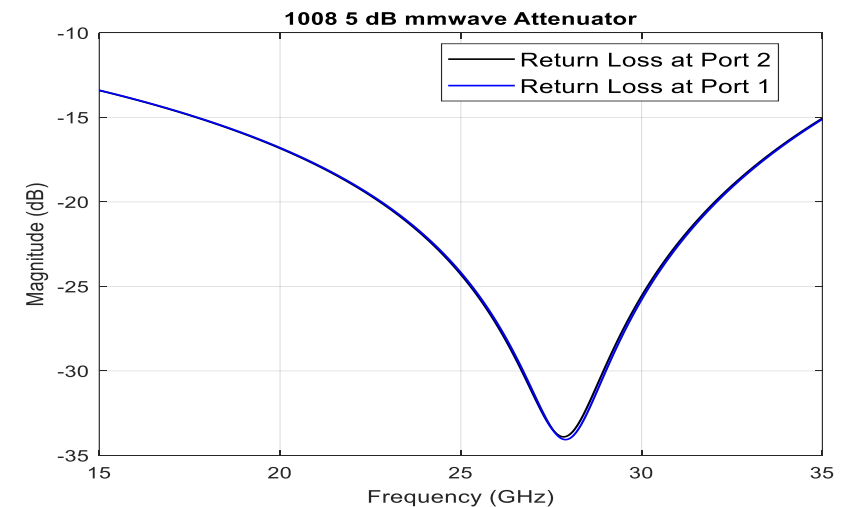
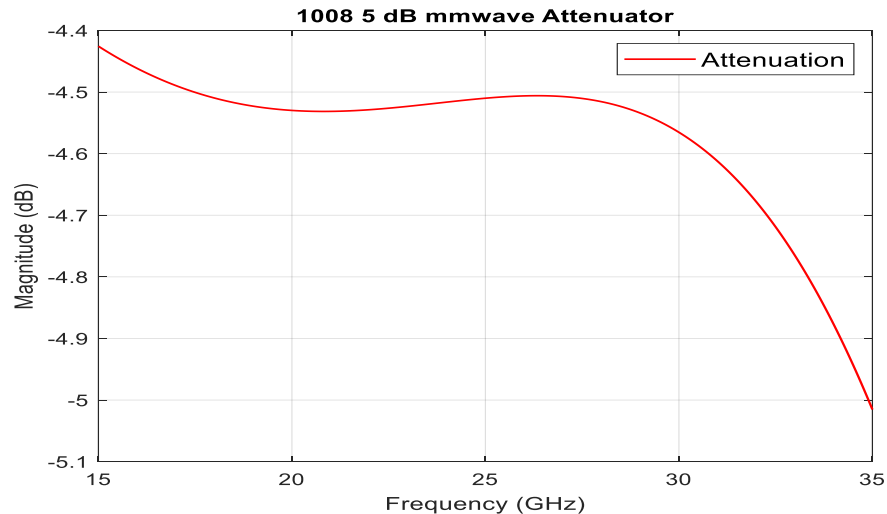
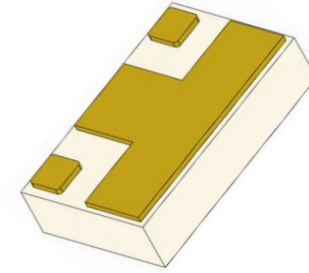

Please contact Mark Bowyer with any questions; mark.bowyer@ttm.com



Inspiring Innovation

New Technologies - Engineered Thermal Solutions (ETS)

ETS Process

- ETS Engineered Thermal Features
 - TTM has develop a patent pending process that allows for solid copper plated cavities
 - 100% copper fill to replicate a copper coin
 - Superior grounding integrity for higher reliability and repeatability
 - Weight reduction achieved by using selective ETS
 - Standard and T-shape structures (replicating T-shaped coins) can be realized
 - Easily replaces via farm and coins in existing designs

Traditional Via Farm cross-section

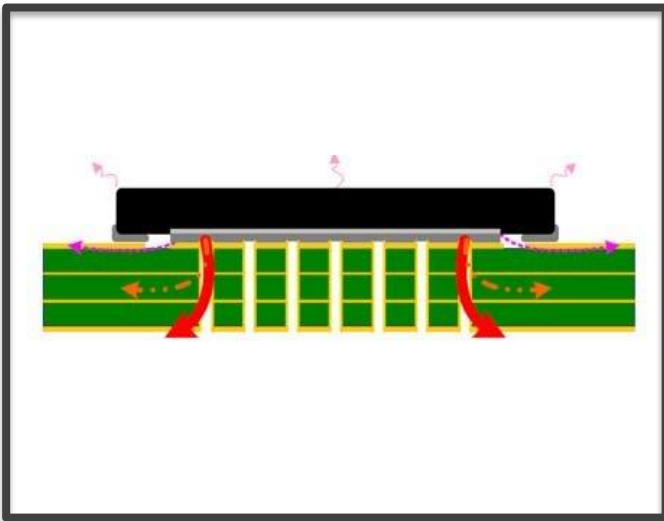

Standard Coin cross-section

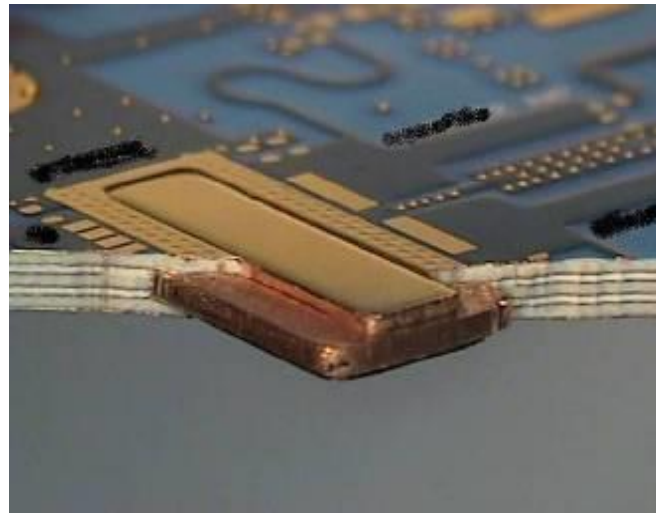

ETS cross-section

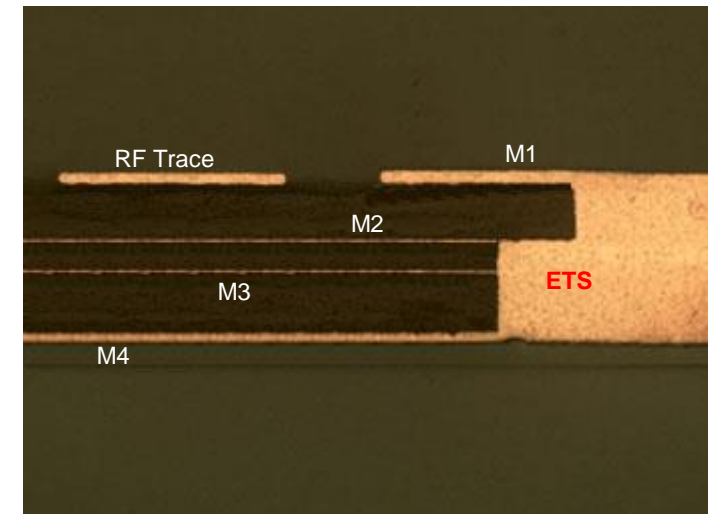

ETS Key Thermal Improvements

- ETS can be applied in 2 ways
 - 1:1 direct coin replacement (not cost effective)
 - **Selective improvement to specific thermal areas**
- Selective ETS can be very small and more flexible versus standard coins
 - Smallest ETS area – 0.015" x 0.030" (0.38 x 0.76mm)
 - As a reference, Coin Size in the image below – 0.24" square (6.1mm)
- Selective ETS greatly improved PCB space utilization
 - ETS requires only 30% space required for direct coin replacement (For this application)
 - Helps to reduce design size, layer count and mass

ETS can be designed in unique shapes

